

IDWedgeBT[®] Quick Start Guide

Contents of Box:

- 1.) IDWedge BT Scanner
- 2.) USB Cable
- 3.) 12V Charger

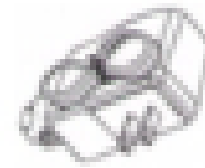

12V Charger



USB Cable

IDWedge BT Interface

1. Power Button
2. Battery Level Button
3. Battery Status LEDs
4. Function/Keyboard Button
5. BT Connection Status LED
6. 2D Barcode Slot
7. Magnetic Stripe Slot
8. Green Power LED
9. 12V Charging Jack
10. RJ50 Jack



12V Charging Jack

RJ50/USB Jack

Charging the IDWedge BT

- Charge scanner before first use.
- Only use the supplied power supply, other power supplies may damage unit.
- Charging is complete when battery meter reads 5 solid blue bars.
- The battery should last about 8 hours with no scans and about 6 hours under constant use.
- A charging cycle should take about 4-5 hours from empty.

Note: Scanner will power on if connected by USB cable but this will not charge the internal battery

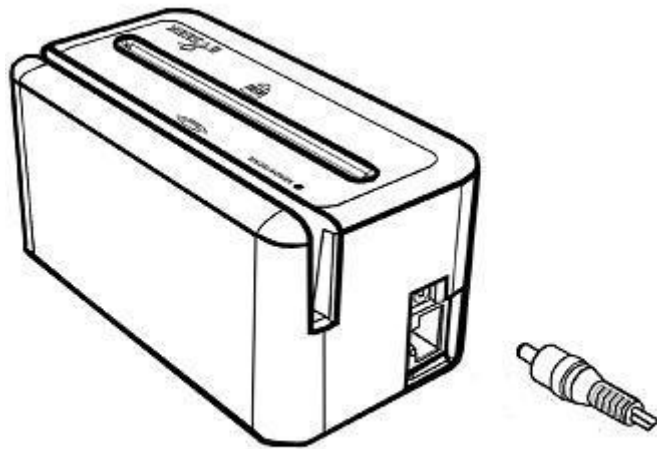

12V Charger

Pairing the IDWedge BT with an iPad

To pair the IDWedge BT with your iPad:

1. First go to Settings -> General.
2. Turn on Bluetooth.
3. IDWedge BT will show up under "devices" as "not paired".
4. Tap on IDWedge BT and the connection will become "paired".
5. Navigate to a web page (e.g. www.idscanner.com/idwedgebt.htm) using safari and tap the screen to put the cursor on the first field you want to be filled.
6. Now you can scan a card.



Pairing your IDWedge BT with an Android Device

To pair the IDWedge BT with an Android device:

1. Go to Settings, then Wireless and networks, then Bluetooth settings.
2. Your phone will search for devices.
3. You'll see an entry under "bluetooth devices," go ahead and click on the IDWedge BT device.
4. You should pair automatically.
5. You are now ready to scan a card.

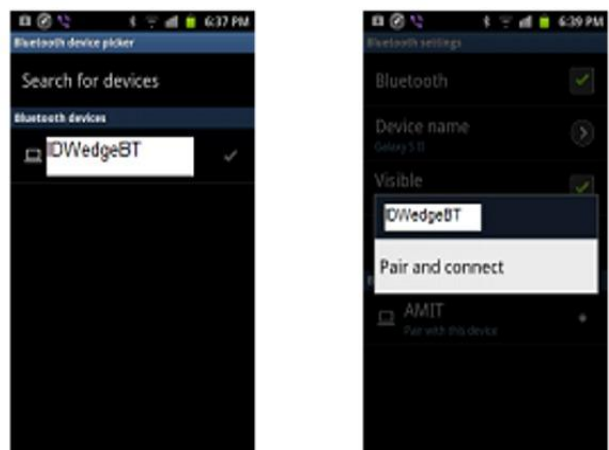

License Data Stripe Technology

- The ID Scanner reads 2D barcodes as well as magnetic stripes. This section explains how to recognize which one is on the driver's license.
- If a license has both, we suggest you scan the 2D barcode first and then the magnetic stripe to verify the information on the screen is the same from both.
- Note: *The scanner does NOT read 1D barcodes because ALL states have either a 2D barcode or magnetic stripe.*



2D Bar Code (PDF 417)

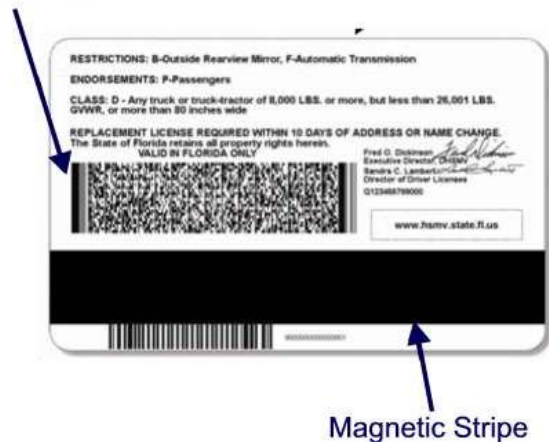

MILITARY IDS

To Scan Military IDs, ONLY SCAN THE **2D BARCODE**.
Do NOT scan the 1D barcode or magnetic stripe.

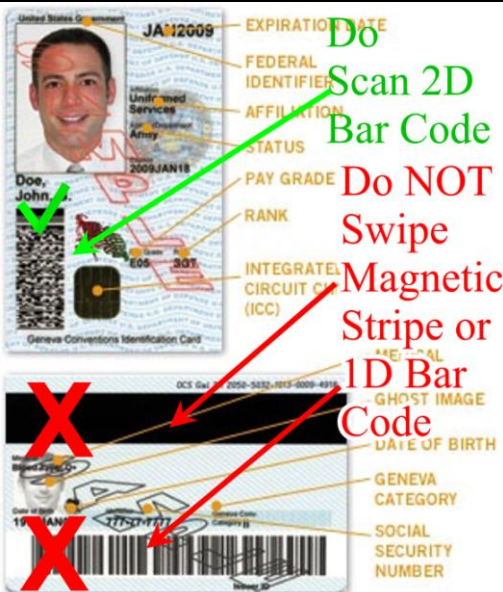

How to Scan or Swipe A License

2D Barcode Scanning:

- For states like New York with 2D barcodes, and Military ID's, insert the barcode facing the slot as shown.
- Dunk down completely and then remove.
- Scanner will beep, indicating it has successfully read the information on the card.

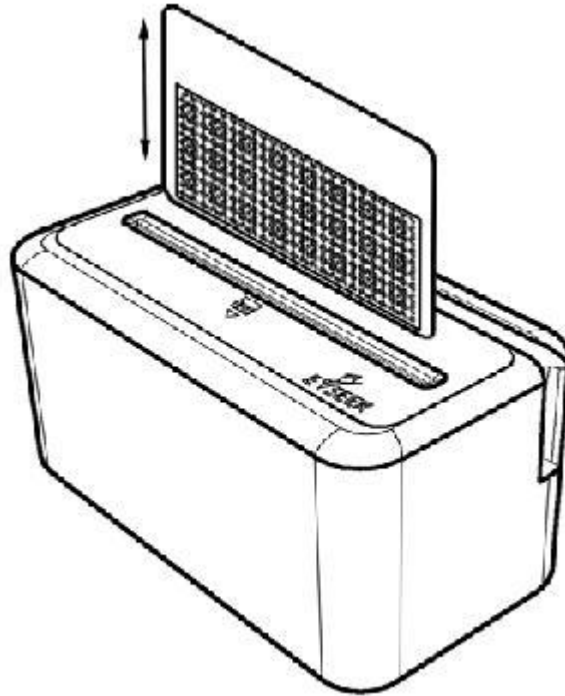

Magnetic Stripe Swiping:

- For states like California with a magnetic stripe, swipe the license with the magnetic stripe facing the slot as shown.
- Scanner will beep, indicating it has successfully read the information on the card.

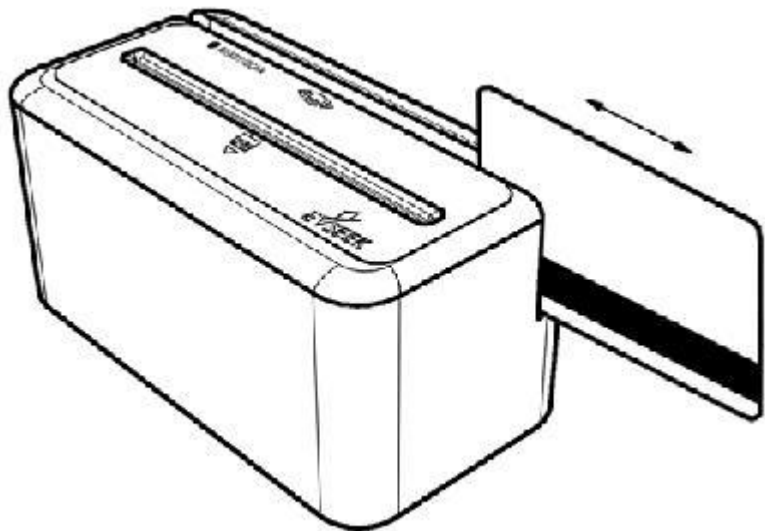

Configuring the IDWedge BT: Changing the Formula

- To change the formula, you must gain access to the formula files on the SD card inside the IDWedge BT.

To do this:

- Turn the unit off.
- While the unit is turned off, hold the battery button down and connect the USB cable from the PC to the IDWedge BT.
- Wait 5-7 seconds, or until you hear the triple beep, then release the battery button.
- The device should now appear as a new storage device in the My Computer section on your PC.

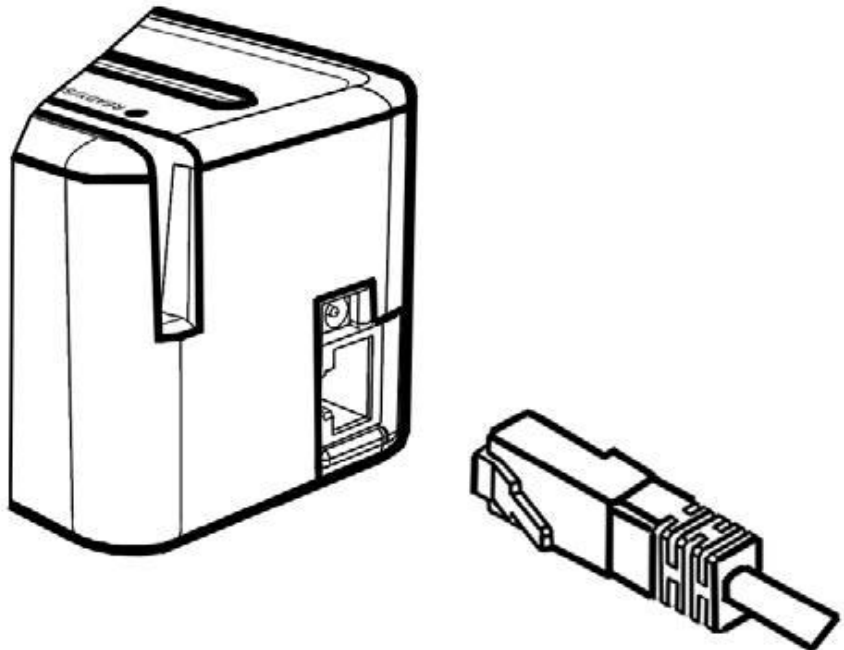

See user manual for details on configuring unit

TokenWorks provides the IDWedgeBT scanner to automate and document the ID scanning process using a wireless Bluetooth connection to the host device. The IDWedgeBT scanner can read 2-d Barcodes, and Magnetic ID cards, as well as credit cards and other Magnetic Cards.



www.IDScanner.com - Product Information
www.TokenWorks.com - Company Information

3511 Silverside Rd, Suite 105
Wilmington, DE 19810
Phone: (800) 574 5034

Support@TokenWorks.com
Revision: 1.0 July 2012