



User's Manual

The New VM-3



The VM-3 Multimedia Video Message Generator

The Video Messenger Company
862 Judson Place • Stratford, Ct. 06615
Phone:(203)358-8842 Fax:(203)547-6216
email: [:vmc@videomessenger.com](mailto:vmc@videomessenger.com)
Website www.videomessenger.com

Introduction.....	Page 1
Quick Start Guide.....	Page 2
Menu Access.....	Page 3
The Message Menu.....	Page 3
Menu Navigation.....	Page 3
Creating a crawl message.....	Page 4
The Text Menu.....	Page 4
The Page Menu.....	Page 4
The Scheduling Menu.....	Page 5
The Routing Menu.....	Page 5
The Utilities Menu.....	Page 6
The Preferences Menu.....	Page 6
The Setup Menu.....	Page 6
What should you do now?.....	Page 7
Function and Menu Commands At A Glance.....	Page 8
Function and Menu Commands At A Glance Cont'd.....	Page 9
Function Keys.....	Page 10
Short Cut Keys.....	Page 11
Basic System Components.....	Page 12
Components of the DV Pro Media Player Upgrade.....	Page 13
Basic Installation of the VM-3.....	Page 14
Installing a Network of VM-3's.....	Page 15
Installing the DV Pro Media Player Upgrade Package.....	Pages 16-17
VM-3 Specifications.....	Page 18
Changing the chips on the VM-3.....	Page 19
VM-3 Menu Map.....	Page 20
VMC's Warranty.....	Page 21
Sample Wiring Diagrams.....	Pages 22-30
Basic insertion into a cable head end.....	Page 22
Multi-Channel installation with cable service... ..	Page 23
Basic conference center installation.....	Page 24
Multi-Channel installation – stand alone.....	Page 25
Complex court house installation.....	Page 26
Hotel Information channel.....	Page 27
Multi dwelling unit with camera.....	Page 28
Modem system installation.....	Page 29
Cable System With Tuners At Each TV.....	Page 30
Troubleshooting.....	Page 31

Introduction

The Video Messenger VM-3



The Video Messenger VM-3 is an innovative, multimedia communications device that is much more than a character generator. It allows you, the user, to effectively communicate with your customers, guests, residents, students, etc., using text, digital images and video clips. You can educate, inform and motivate your target audience in ways that would have cost thousands of dollars more before the introduction of this little giant. This installation manual allows you to take maximum advantage of the VM-3. Start with the Quick Start Guide, which starts on the next page.

The VM-3 will allow you to:

- *Display hundreds of pages of text messages on your TV's.*
- *Schedule these messages by time of day, day of week and date range.*
- *By using our network unit (the VM-3NET), you can distribute specific messages to designated locations and maintain control from a single location.*
- *Display text in dozens of colors and brightnesses.*
- *Link text messages to high quality digital images and/or video. This video is in MPEG (a common digital format).*
- *Take control of what your target audience is exposed to while in your location with a high impact presentation.*



VM-3 Quick Start Guide

They just installed the Video Messenger and your boss gave you a list of messages to input and a schedule of their playing times. Don't panic! Follow some of the simple procedures outlined below then promise you will read the rest of this manual as soon as possible to learn all there is to know. So – let's start!

The VM-3 displays two types of messages: a full screen message (that takes most of the page) and a crawl message (that crawls along the bottom of the screen).

TO CREATE A FULL PAGE MESSAGE:

Press the F1 KEY - a blank screen will appear with the cursor blinking in the center.



Blank screen using the VM-3 internal video

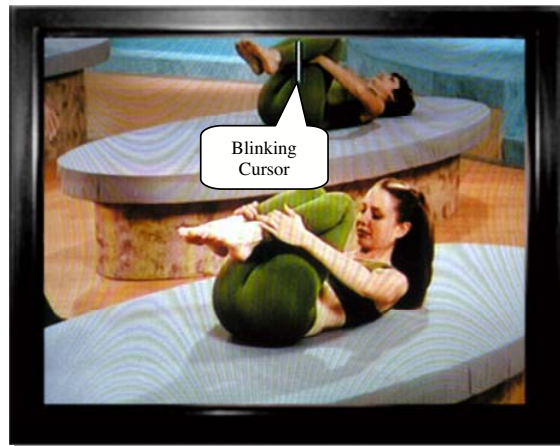

Blank screen using external video

Type in a line of your message like you would into a word processor. The ENTER KEY will jump the cursor to a new line. Every time you **press the ENTER KEY**, you will create a new paragraph, even if you only type one line before you press the ENTER KEY again. **This is important because colors and fonts are controlled by paragraph.**



So now what?

Press the F9 KEY to Save and the **F8 KEY to Play**. Now, more details...

The VM-3 has nine menus that allow you to assign various qualities to a message like font style, size and color; when the message will play; how long it will stay on the screen and what image or video (if a DV Pro Media Player is attached) is to appear with it. We call these qualities **attributes** and they are frequently mentioned in this manual. (Note that pressing and holding the CTRL then the F key will change the font styles, while the S key will change the size.)

HOW DO YOU ACCESS THE VM-3 MENUS?

Simply, press and hold down the (CTRL) KEY in the bottom left hand corner of the keyboard.

The Main Menu will appear listing all the sub menus:



To get into any menu, **hold down the CTRL KEY**, select the menu with the **UP AND DOWN ARROW KEYS** and press **ENTER**. To return to the Main Menu press the **ESC KEY** while holding down the **CTRL KEY**. (Notice how the font and background colors are controlled by paragraph, which is defined with by pressing the **RETURN KEY**).

What is the MESSAGE Menu?



The Message Menu allows you to quickly select the message you wish to edit. While holding down the **CTRL KEY**, use the **UP AND DOWN ARROW KEYS** to make a selection-the message instantly appears on the screen. (Notice that the bottom part of the Message Menu allows you to perform some basic message utilities that will save you much time if you learn to use them effectively).

Want another way to select a message?

If you know the message number you wish to edit, press the (**go to**) KEY in the number pad section of the Keyboard. A dialog box appears **Go to Msg** with brackets [] appearing below it. Type in the message number you want to select in the brackets and press **Enter**.

How DO I NAVIGATE THESE MENUS:

While holding down the **CTRL KEY**, tapping the **TAB KEY** will move the selection down and to the right. If you hold down the **CTRL KEY** and the **SHIFT KEY**, tapping the **TAB KEY** will move the selection up and to the left. Once you are in the right selection box, the **UP AND DOWN ARROW KEYS** change the value of the message attribute selected.

TO CREATE A CRAWL MESSAGE:

Press the **F3 KEY** - a blank blue screen will appear with the heading "Edit Crawl Message" with the cursor blinking in the center



This crawl message will play the current time and date when it displays at the bottom or top of the screen. Many users employ the crawl line to make special announcements in conjunction with full-page message displays. It is also useful, if you are showing a broadcast show and do not want to interfere with the broadcast. The crawl line will only show on the bottom or top 2 or 3 inches of the television set. The location of the crawl line can be set in the Preferences Menu by selecting or deselecting the crawl on top option.

What is the TEXT Menu?



The Text Menu allows you to change the **Font Style, Color and Brightness**. If you are using Internal Video (the VM-3's own internal video generator), you can also change the Background Color and Brightness. Remember the changes you make will only apply to the paragraph where the cursor is located. **Pressing A** while holding down the **CTRL KEY** to Select All will apply your changes to the entire message. Releasing the **CTRL KEY** will release the Select All option.

HELPFUL HINT! You don't need this menu at all! If you learn the short cuts, in the short cuts section that follows, you never need to access this menu. They are also listed on the Keyboard.

What is the PAGE MENU?



The Page Menu allows you to decide on the following:

- Internal or external video.
- The image/video track (Media Player only).
- The duration of the message (how long it will display).
- Whether or not to show the clock at the top of the message. **CTRL + H** is the short cut KEY for this option.

What is the SCHEDULING MENU?



The Scheduling Menu allows you to decide when a message will display. You can schedule a message by time of day, day of week and within date range. This menu gives the VM-3 real power because it allows you to input your messages days or months in advance and automatically run them during the appropriate time. You navigate the menu the same way you navigate the PAGE and TEXT MENU. In addition, the **ENTER KEY** will mark or unmark a day or option within a selection box.

Remember, if you want to schedule a message for a specific time of day or date; the Always Time and Always Date lines must be unmarked! (NO CHECK MARK)

What is the ROUTING MENU?



The Routing Menu allows you to send a message to any or all of the VM-3NET's connected to the VM-3. Routing allows the VM-3 to be a multi-channel, as well as a multimedia device that can distribute messages to different channels or locations in a your facility at the push of a few keys. Up to 32 VM-3's can be networked in this fashion. Like other menus, the **ENTER KEY** will mark or unmark a box number within a selection box.

Helpful hint! When you open the Routing Menu, all 32 box numbers will be checked. This is the default state. Hold down the **Ctrl + Alt Keys** and press the **Return Key** twice, all the checks will disappear except for the one on the selected (highlighted) box number. Once this is done, you can arrow to any box number and press the return key to check that box. The **Tab Key** will move you between box sets.

What is the UTILITIES MENU?



The Utilities Menu allows you to do system wide functions like:

- Set the VM ID's to give each box it's own address #
- Download (Xmit) Preferences, the Clock and so on to networked units.
- Delete all the messages in a unit with **Reset ALL**
- This menu also allows you to control an optional modem, which can dial out to another VM-3 to download messages remotely.

What is the PREFERENCES MENU?



The Preferences Menu allows you to set system wide preferences like:

- Auto Xmit which downloads new messages to the other networked boxes when you save a message.
- Turn on Smart Video, which is used when you display messages over external video.
- Turn on Internal Video Override (Int Video OR) which instructs the system not to look for external video, preventing messages from flashing.
- Turn on or off the crawl on top command. The system default is to crawl on the bottom of the screen.
- Set the Startup Mode.

What is the SETUP MENU?



The Setup Menu allows you to set the clock, day of the week and calendar date. It also allows you to specify the type of remote device connected to the RS 232 jacks, (i.e. Media Player, modem, IP/LAN interface etc.) and the wait time between crawl message presentations. Lastly, you can verify and manually set the VM-3's ID #.

When using the VMX Pro Media Player Comm A should be set to DVD 175 command set. This menu is usually accessed only when initially installing the VM-3 system

WHAT SHOULD YOU DO NOW?

- Review and learn the menu navigation and function keys.
- Review and learn the short cut keys at the bottom of the keyboard.
- Review the menu map (attached).
- Don't panic, the VM-3 is really user friendly and worth your small investment in time to learn it.
- If all else fails call your dealer or Video Messenger at (203) 358-8842. We will be glad to help you move through its short learning curve.
- Finally, you can see a color presentation of this manual by downloading the VM-3 Manual from our website at www.videomessenger.com/downloads.

Function and Menu Commands At A Glance

Some time saving Menu Functions:

While in the Message Menu the following keys are active...

Insert Key:

Creates an empty message slot before the current message.

Delete Key:

Deletes the selected message slot causing messages that follow to be moved up in the list by one slot or message number.

Page Up:

Causes selected message to leap frog one place up on the message list.

Page Down:

Causes selected message to leap frog one place down on the message list.

Compact List

This menu command will re-sort the message list getting rid of "holes" in the list.

Home Key:

Automatically brings you to the top of the message list

End Key:

Automatically brings you to message #250

Message Utility Functions:

Compact List

Clear Text

Clear Msg

Delete All

Delete Old

This allows an auto delete function for all messages that will never again play because their date range has past.

XMIT Msg

This will do the following:

Transmit Clock Settings

Transmit Machine Preferences

Transmits **only the current message** to the networked units.

XMIT Msgs

Transmit Clock Settings

Transmit Machine Preferences

Delete messages in networked units

Transmit all messages to networked units

Req Msg

Allows you to upload the selected message number from a remote VM-3

Req Some

Allows you to upload a range of messages numbers from a remote VM-3

Utility Menu:

OSD On/Off

Reset All (Set VM-3 to factory defaults)

Set VM ID's (Each VM-2 should have a unique ID Number)

The ID is displayed in the Setup Menu. The ID's may be set for all networked units by using the Set VM ID's command in the utilities menu.

This will Auto ID each networked unit in the order that they are connected.

Terminal functions allow you to operate the system with an optional modem.

Preference Menu:

Auto XMIT

(This item should have a check mark if you want a copy of the message sent to networked units as you modify and save them).

Smart Video

(This item should have a check mark when **only** crawl line messages are being use over external video. This preference selection ensures the VM-3 always looks for an external video signal before putting up it's own internally generated screen).

XMIT Preference

(whenever a message is saved in the Master unit, it will be sent to the networked units along with the clock settings and preferences).

XMIT Clock

(updates the networked units with the time and date in the master unit).

FUNCTION KEYS:

KEY: -- FUNCTION:

Ctrl -- Press and release for edit mode to type and change text
Hold down to change message attributes (text color, brightness, font, scheduling etc.)

Esc -- With Ctrl Key held down, returns to the main menu

Arrow -- Used to change or pick a selection within a specific attribute box

Enter -- With Ctrl Key held down, will open a sub menu

Tab -- Used to navigate to different menu boxes

F1 -- brings up the next available **new**, blank **full page message** screen

F2 -- allows **editing** of a **full page message**

F3 -- brings up the next available **new**, blank **crawl message** screen

F4 -- allows **editing** of a **crawl message**

F5 -- Moves to the **previous** message while in the edit mode

F6 -- Moves to the **next** message while in the edit mode

F7 -- Puts programming in a **pause** mode indefinitely

F8 -- Activates the **play** mode

F9 -- **Saves** the edit changes made to a specific message

F10 -- **Previews** a message with attributes such as duration and image link

F11 -- **Copies** all the text and attributes of a message into a clipboard to paste over another message

F12 -- **Pastes** the text and all attributes of a message into a blank message

****VM-3 KEYBOARD SHORT CUT KEYS:****

KEY: -- FUNCTION:

Ctrl C -- Center align text

Ctrl L -- Left align text

Ctrl R -- Right align text

Ctrl F -- Font style (five rotating selections)

Ctrl S -- Font size (four rotating selections)

Ctrl P -- Preset color combination (16 preset font and background combo's)

Ctrl T -- Select color of text (16 colors)

Ctrl B -- Select brightness of text (8 selections per color)

Ctrl Alt T -- Select color background (16 colors)

Ctrl Alt B -- Select brightness of background (8 selections per color)

Ctrl A -- Select all text (paragraphs) of a message

Ctrl V -- Switch between internal and external video

Ctrl H -- Switch time/date header option on and off

Delete or Backspace -- will delete one character at a time.

Shift Delete -- will delete text in a paragraph.

Alt Delete -- will delete text in a message, leaving the attributes alone (font size, color etc.)

Shift Alt Delete Save -- will delete entire message.

Home -- move the cursor to the top of the first message page.

End -- moves the cursor to the end of the last message page.

"^t" -- sets time for crawl message.

"^d" -- sets date for crawl message only.



Components of the VM-3 Basic System

When you unpack the VM-3, the basic system will include the following:

1 Video Messenger VM-3



1 Standard 101 AT Keyboard (Black or Baiae)



1 Standard IEC 320 Power Cable



2 6ft. BNC to RCA Video Cables



1 Owner's Manual

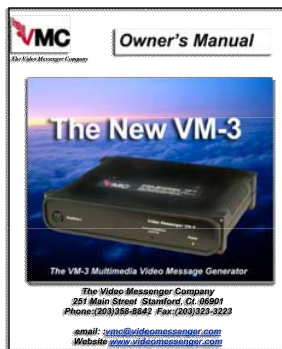

1 Warranty Card



**Questions? Call us at
(203) 358-8842**



Components of the DV Pro Media Player Upgrade Package

The Media Player Upgrade Package (DV#1) includes:



The DV Pro Media Player with 512 MB Compact Flash Card. The unit can play back on command Mpeg 1, 2 & 4 video, Mpg3 audio and jpeg & bmp stills.



256 MB USB Flash Drive for updating the DV Pro Media Player



DV Studio Plus Authoring Software. This software allows the user to add images and video to the Compact Flash Card for use in the DV Pro Media Player. With this software, the player can be set up to act as a server for the VM-3 or automatically present a play list by itself.



The VMConsole allows the user to control VMC's Hotel Information Channel directly from a Windows® PC. The software also allows the user to connect to the VM-3 box using the VLinx Option (below) through a LAN or world wide web.



Two 9 pin serial cross over cables. One to control The VMX Pro Media Player and one to control the VM-3 from a Windows® PC.



Power Cord and Video Cables with BNC Connections

For remote LAN/Internet access add:



The VLinx IP/Serial Interface Box is an option that allows the user to give the VM-3 an IP address and link to it through a LAN or the world wide web.

*Customized video editing services are available from VMC directly.

Basic Installation of the VM-3

The instruction step numbers correspond to the numbers in the diagram to the right.

1. Unpack the VM-3 and place it where you can have easy access to the rear panel.
2. Using one of the Standard (BNC TO RCA) Cables, connect the BNC end to the jack marked 'Video Out Edit.' Plug the RCA end into an edit monitor.
3. Using the other Standard (BNC TO RCA) Cable, connect the BNC end to the jack marked 'Video.' Plug the RCA end into the television system. In most cases this cable is plugged into a modulator (using an RCA to F adaptor) or a display monitor. If the modulator is farther than 6 feet away, a custom cable will have to be made by your installer.
4. If external video is going to be used, connect another Standard (BNC TO RCA) Cable to the jack marked 'Video In.' The other end of this cable can be connected to a VCR, Satellite Receiver, Camera, DVD player or any device that has a video output jack.
5. Turn the VM-3 so you can access the front panel. Plug the keyboard in the Din jack marked 'Keyboard.'
6. Connect the power cord from the VM-3 to an electrical outlet or recommended surge protector.
7. Call (203) 358-8842 if you are having a problem completing these steps.

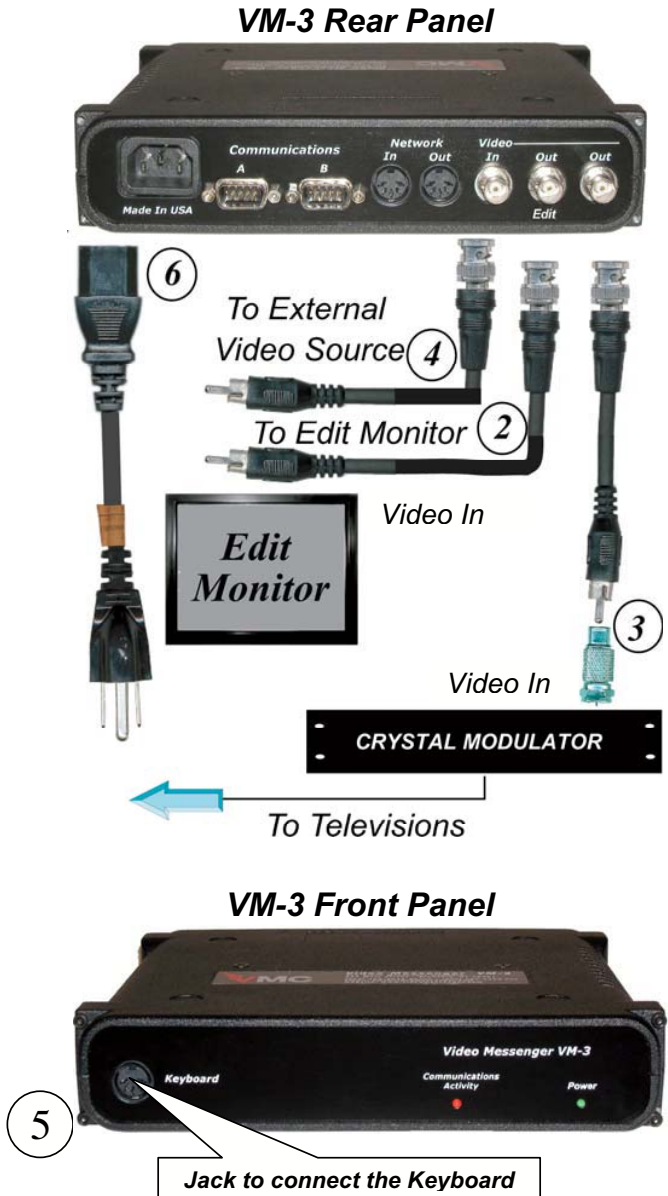



Installing a Network of VM-3's

These instructions assume you have completed the basic installation.

The VM-3 unit is very easy to network with other VM-3's. Connecting VM-3NET's to a VM-3 Control Unit allows the operator to send different messages and image/video links to more than one location or video source. This can be done from one location while maintaining control of the entire network.

1. After performing the basic installation on a VM-3NET, simply connect the din cable pictured to the right from one VM-3 to the next. This connection is made through the 'Network' ports. The 'Network Out' Port is connected to the next VM-3NET's 'Network In' Port. This is repeated until all the VM-3NET's are connected.

2. After all the units are powered up, the VM-3 Control Unit knows how many VM-3NET's are connected. Setting the VMID's is done from the Utilities Menu. This gives each box a unique address.

3. VMX Pro Media Players can be installed on any or all of the VM-3NET network units.

4. Controlling the VM-3NET's is done through the Routing Menu while editing with the VM-3 Control Unit.

5. Call (203) 358-8842 if you are having a problem completing these steps.



Installing the DV Pro Media Player Video Package

The instruction step numbers correspond to the numbers in the illustrations to the right.

1. Unpack the DV Pro Media Player and place it on top of the VM-3 where you can have easy access to the rear panels (as shown). Turn on the VM-3 by plugging in the black power cable.



2. Find the Interface (Black) Cable. Insert the 9-pin end into the Comm A Port on the VM-3 and the Mini Plug end into the RS 232 jack on the DV Pro Media Player.



3. For audio, insert one end of the RCA cable (provided) into the audio out (Red jack for mono) on the Player as shown. For stereo use two RCA cables. Insert the other end(s) of this cable into the audio-in(s) of a TV, amplifier or an RF modulator.



4. Attach the BNC end of one of the black Video Cables to the Video (in) plug on the VM-3. The other end of this cable is a standard RCA plug. Insert this end into the back of the Player. Look for a yellow jack marked "Composite".

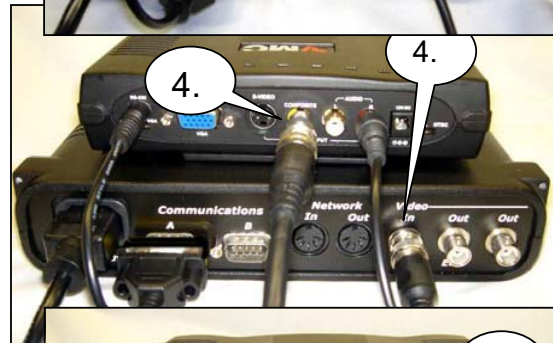

5. Attach the BNC end of the other black Video Cable to the Video (out) plug on the VM-3 (marked Edit). The other end of this cable is a standard RCA plug and can be inserted into an edit monitor or other video display. Using this plug allows the user to edit off line.





Installing the VM-3 Video Upgrade Package Continued...

6. The last Video Out (unmarked) is for insertion into a modulator or video display to be seen by intended viewers. This is usually a custom made cable provided by your installer.



7. Connect the power cord on the DV Pro Media Player to an electrical outlet or recommended surge protector. Turn on the VM-3 by connecting the power cord.



8. At this point, you can insert the Compact Flash Card (provided) that contains your images and video.



9. Turn on the DV Pro Media Player by pressing the power switch. The player will take about 10 seconds to boot up and will show the first track on the play list.



10. Now you are ready to get started. Using the VM-3's keyboard, go to the Page menu and tab down to Track. With the right hand box highlighted, you can arrow up and down from files 1 to 99. To select an image in a track higher than 99, use the left box to put the first one or two digits of the track number and the right hand box to put in the last two digits of the track number. One second after going to a file number, the Player will display the image or video in that track

Call (203) 358-8842 if you are having a problem completing these steps.

VM-3 Specifications

The VM-3 Specifications

(VM-3) Text Generator & Video Controller

- Color text with multiple font selections
- Schedule by date range, day and time
- Run messages on as many channels as desired (optional equipment required)
- Requires no PC • Extremely user friendly
- 1/2RU • 120VAC, 60Hz or 220VAC, 50Hz
- IEC 320 plug • UL listed

Applications

- Hotels (meetings, internal promotions)
- Conference Centers • Cable Companies
- Banks • Retail • Brokerages • Schools and Institutional • Senior Care • Railroad stations
- Commercial environments • Any application that needs quick and easy information delivery
- Display recreational activities • Meeting schedules • Menu specials • Stock alerts
- Interest rates • Weather & sports updates

Video Attributes

- 640 x 480 resolution • 16 basic colors plus fine adjust • 1 small sized system font (avg. 50 characters across the page) • 3 medium sized fonts (avg. 30-45 characters across the page)
- 1 large sized font (avg. 18-20 characters across the page)

Connections

One video jack (in) and 2 video jacks (out): one for edit monitor and one for TV system or floor display 2X MIDI (din 5): one in and one out • two RS 232 (9 pin) jacks for, external Media Player and remote control via Internet or LAN interface. • Front panel 5-pin connector for AT101 keyboard.

Software

Up to 250 full screen messages or crawl lines

- Color by line • Copy/paste by message
- Copy/paste message attributes • Clear function by selected paragraph • Insert function at cursor position • Date, day/time scheduling by message • Multi-channel operation via daisy chained network units
- Message routing (by daisy chained network units) • Advanced edit navigation features
- Delete by character, paragraph and message
- Font size and style by line and paragraph
- Image and video file linking by page • Flexible message length

- Remote operation via high capacity wireless receiver or modem • Help function on all menus

VM-3 includes a full AT101 Keyboard.....

Note: This system is designed as a video bulletin board with built-in backgrounds of various colors. It will also genlock text messages over any external video source.

VM-3 Local Network Unit

- Allows display of separate messages to be shown simultaneously in separate areas of a location, i.e., cafeteria, lobby, lounge, etc.
- Each Network Unit is addressable with its own ID • Messages can be shared between networked units automatically or manually

The High Impact Video Package

• Links digital images and digital video with your text messages for maximum impact (like a Power Point presentation) • Integrates VM-3 Text and Video Generator & Controller with a DV Media player. This allows the user to play hundreds of high-resolution images and/or MPEG video • The VM-3 plays both images and video clips while overlaying text

The VMConsole

The VMConsole allows for the creation, editing and storage of thousands of messages on a Windows® PC for future use. It also allows the user to control the VM-3 directly connected to a PC's serial port or remotely using an IP/Serial interface box.

The IP Addressing System

Using an IP to serial port converter the VM-3 can be installed on a LAN and controlled via your PC. Users can send data using the VMConsole software which delivers it to the VM-3. The VM-3 converts the data stream into video characters then superimposes them over programming from your cable box, satellite receiver, VCR or DVD Player. The VMConsole also sends the instruction sets necessary to control the VM Media player.



Changing the Chips on the VM-3

There are two flash memory chips in the VM-3. One, the Program Chip, controls the features and functions of the unit. The other flash, Memory Chip stores your messages.

Occasionally, VMC issues a program update to improve features and make the unit easier to use. As a result, you may be asked from time to time by the Video Messenger Company to relay what version of the Program is installed in your VM-3. You can find the software version # at the bottom of the Setup Menu.

To replace the battery, follow the steps below:

1. Unplug the power to the VM-3.
2. Remove two screws on the top of the unit.
3. Pull the top panel off.
4. Locate the VM-3 PROGRAM CHIP as shown in the image below.
5. Carefully pry the VM-3 PROGRAM CHIP out of the socket with the flat edge of a small screwdriver.
6. Insert the new VM-3 PROGRAM CHIP into the socket making sure that the notch is facing right and all pins line up correctly.
7. Press firmly to seat the FLASH PROGRAM CHIP. Make sure there are no bent pins.
8. Re-assemble the top panel.
9. Replace the two screws, being careful not to over-tighten them.
10. Plug the VM-3 into an outlet.

*Inside the
VM-3*

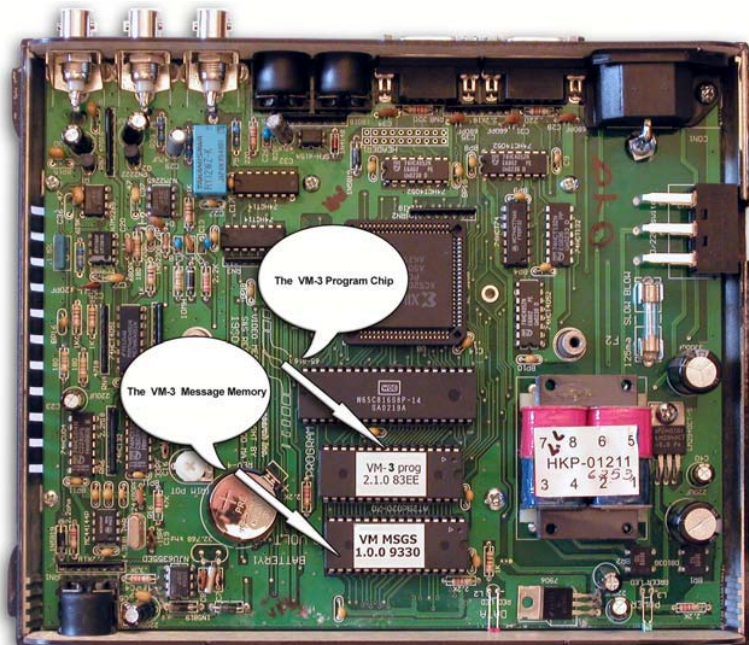

VM-3 Menu Map

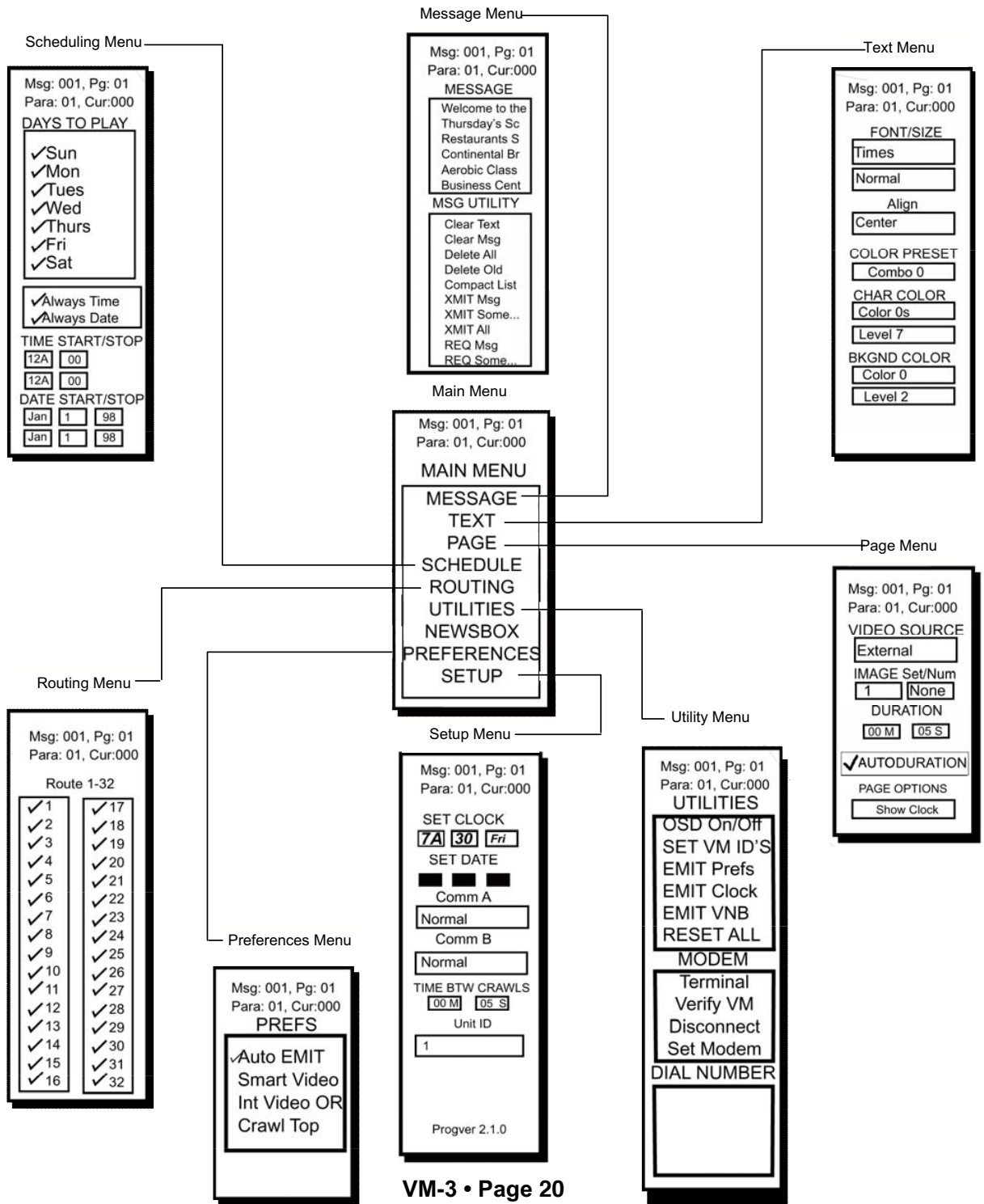



VMC'S Warranty

The Video Messenger Company warrants your Video Messenger to be free from defective materials and workmanship for a period of 1 year. VMC covers both parts and labor.

SHOULD YOUR VIDEO MESSENGER NEED SERVICING DURING THE FIRST YEAR, THE VIDEO MESSENGER COMPANY WILL REPAIR OR REPLACE THE DEFECTIVE UNIT AT ITS DISCRETION WITHIN 72 HOURS OF RECEIPT (not including weekends, holidays, or shipping time).

The following will void the above warranty:

- Abuse
- Accident
- Alteration
- Damage in transit (other than original shipment from factory)
- Failure to return warranty card within 10 days of purchase
- Failure to follow return procedures
- Maintenance procedures not followed
- Modification
- Misuse, including connection with wrong current or voltage
- Negligence

To return a VMC product:

- 1. Call us at (203) 358-8842. We may help you correct the problem by phone. If your unit must be returned, you must obtain authorization before shipment.*
- 2. Ship unit in original factory carton only unless instructed otherwise.*
- 3. Ship via UPS or equivalent and insure for full value.*
- 4. All shipments must be prepaid. No CODs accepted.*

In closing:

We wish you good luck with your new VM-3, and hope you can reap much benefit from this innovative product. Feel free to write us, sharing with us some of the creative ways in which you've tapped into this new method of communicating. If you find your video needs are expanding beyond your present system, please contact us for more information on our full line of Video Messenger products.



Basic Wiring Diagram For Insertion Into Cable Head End For a Bar, Lounge or Restaurant

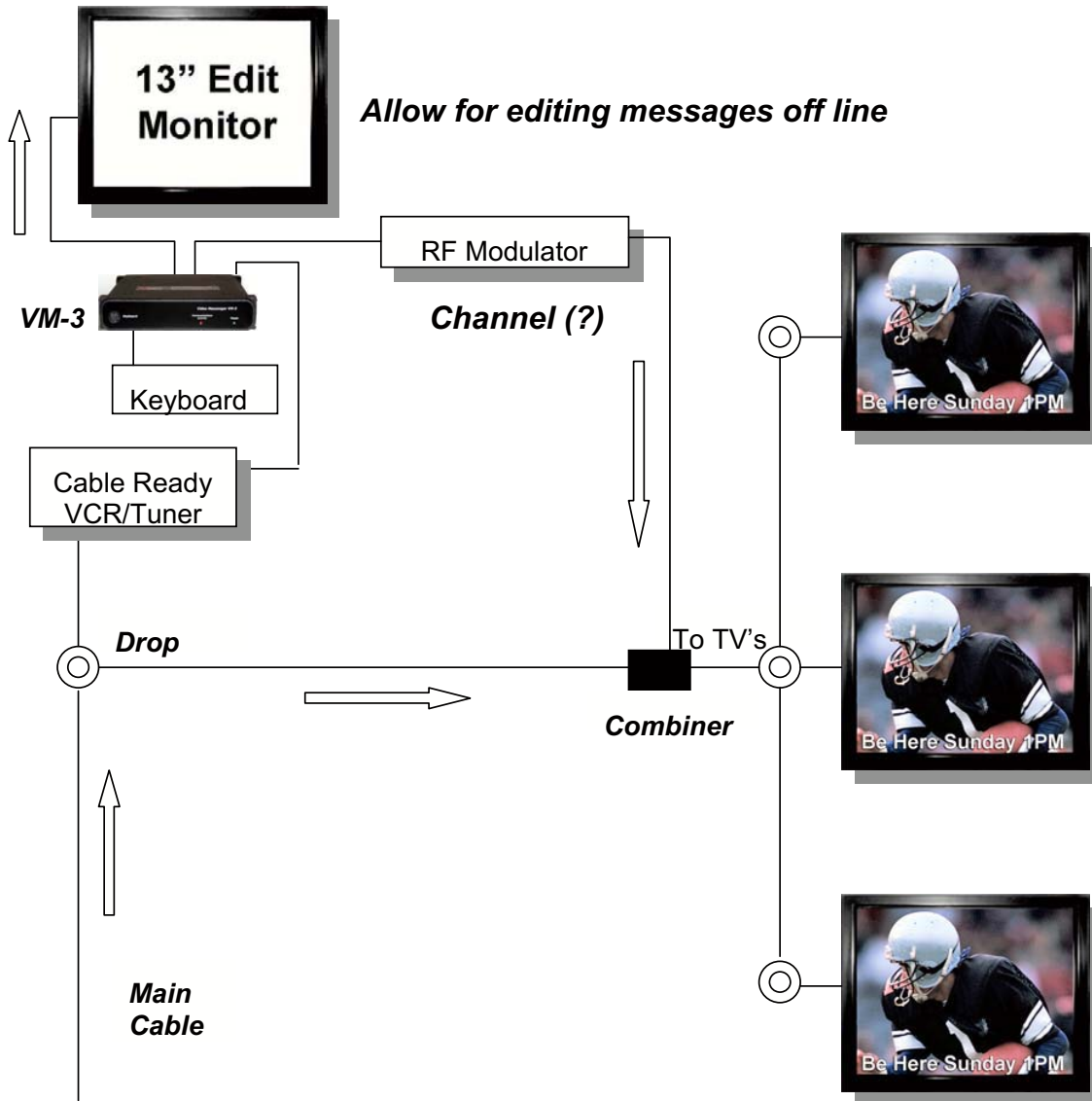

This system allows an owner to insert characters over any cable channel. Channel (#) depends on where there is room in the spectrum to insert a channel.



***Wiring Diagram For Insertion Into Multi-Source
Cable Television System a Bar, Lounge or Restaurant***

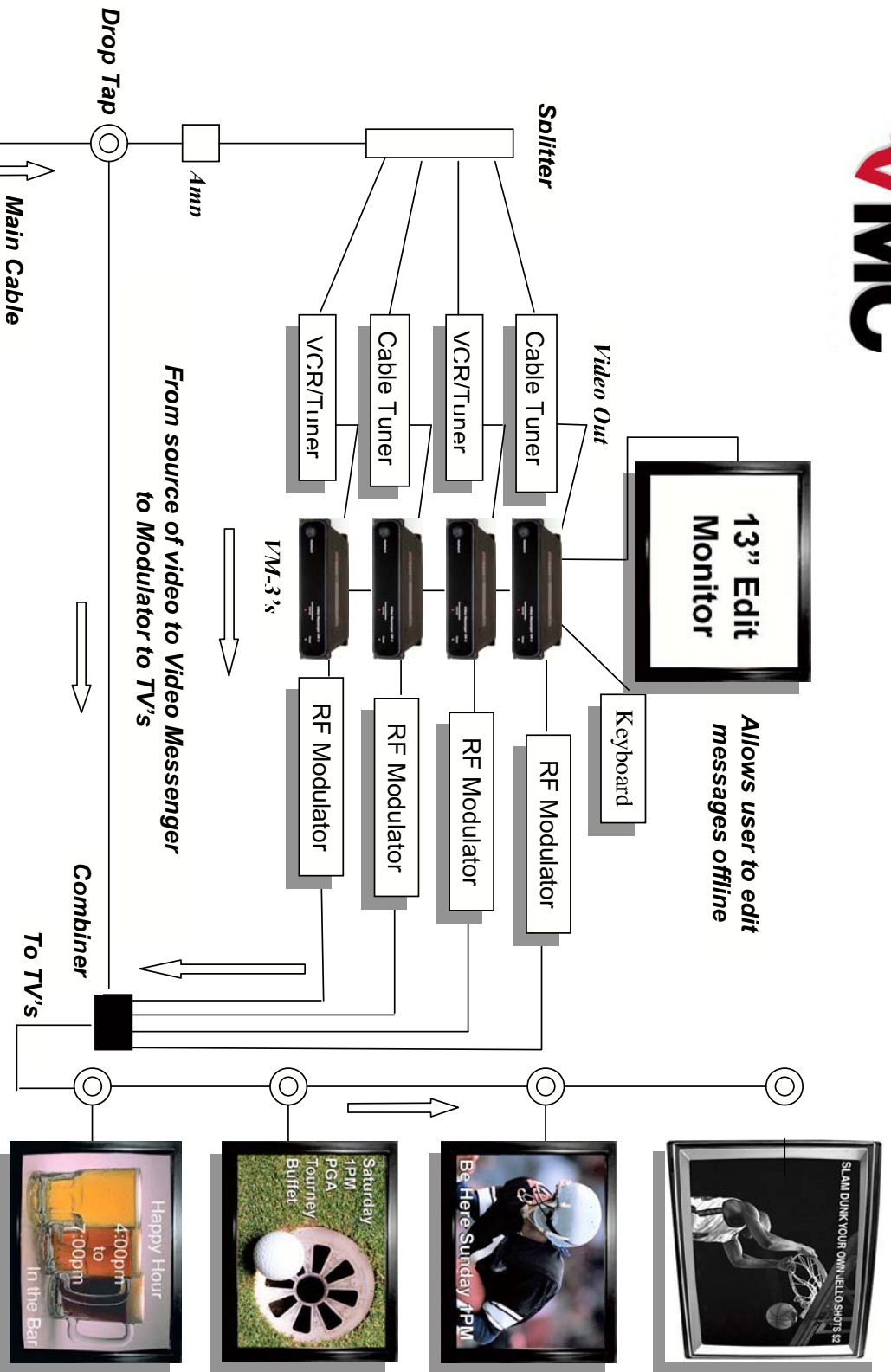

Allows user to edit messages offline

From source of video to Video Messenger to Modulator to TV's

Main Cable

To TV's

This system allows messages to appear on multiple sources of video or programming. In the example above, four video messengers act as one on four separate channels displayed in the bar/restaurant area.



Wiring Diagram For Conference Centers or Facilitites with Different Messages in Various Areas of A Facility - Six Source RF System

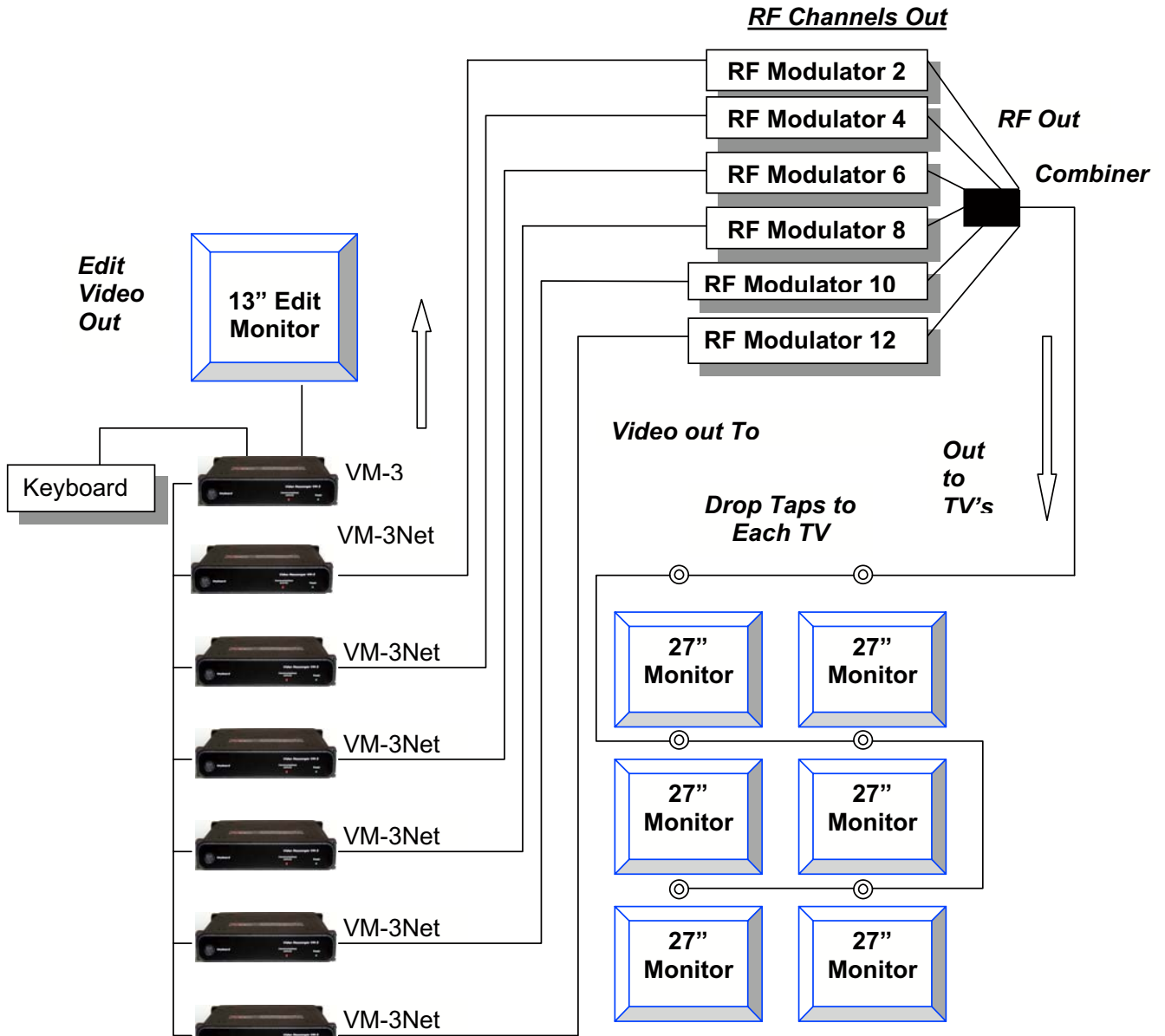

This system allows any TV to display any source by changing the channel.



Wiring Diagram For Insertion Into Multi-Source Television System

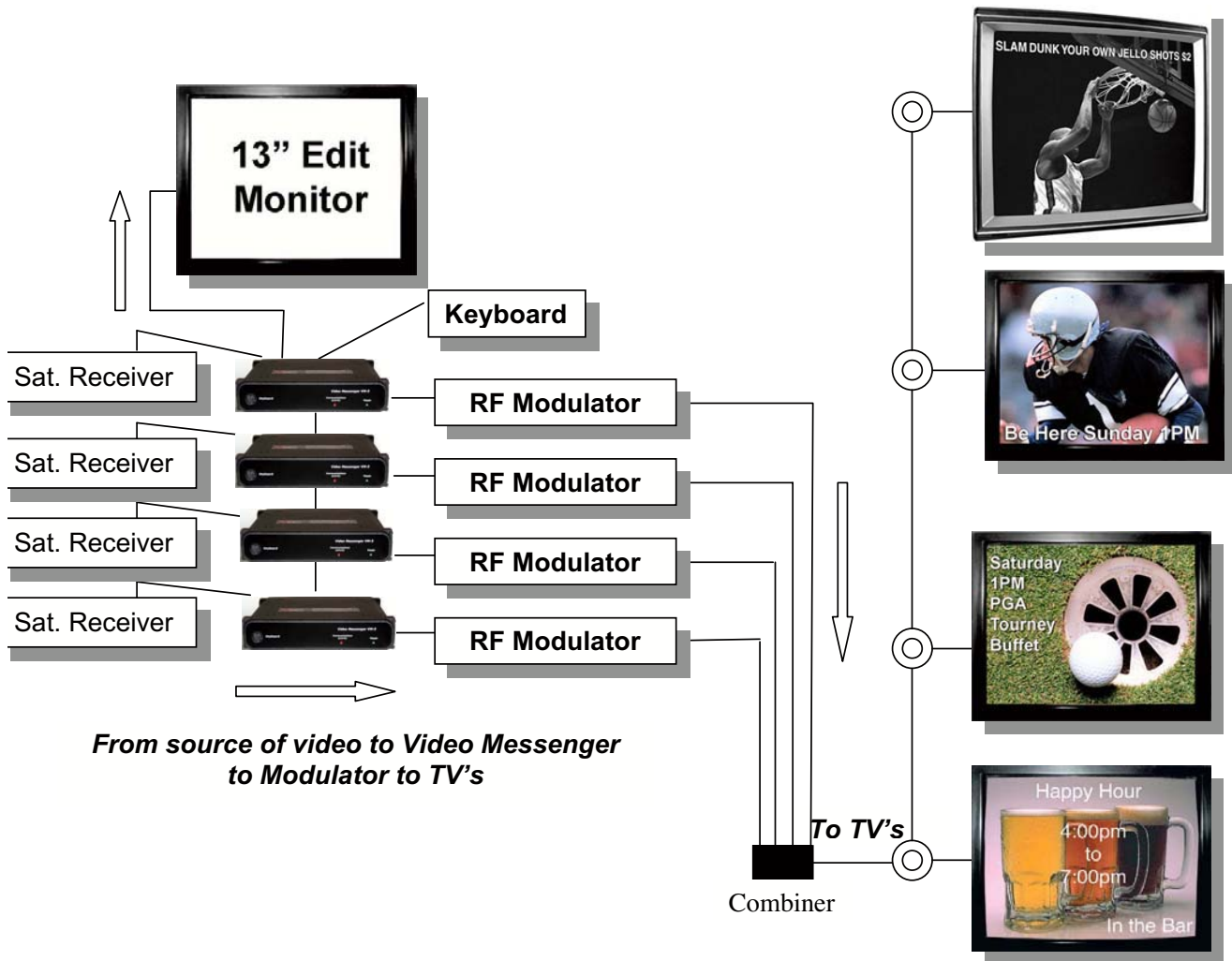

This system allows messages to appear on multiple sources of video or programming. In the example above, four video messengers VM-3's act as one on four separate channels displayed in the bar/restaurant area.



Wiring Diagram For Insertion Into Multi-Source Television

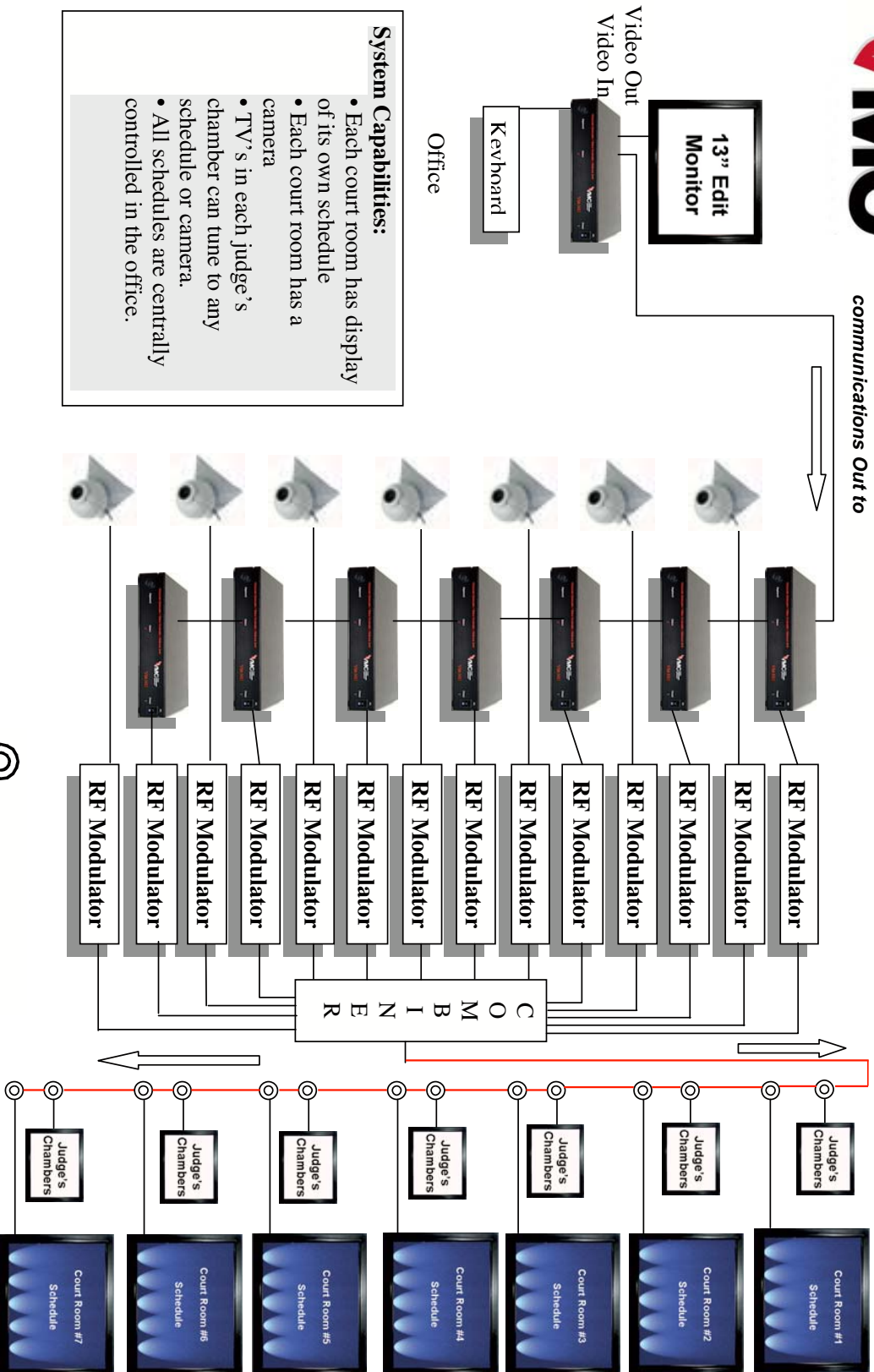

System Capabilities:

- Each court room has display of its own schedule
- Each court room has a camera
- TV's in each judge's chamber can tune to any schedule or camera.
- All schedules are centrally controlled in the office.



Basic Wiring Diagram For Insertion Into Cable Head End or Private Cable System like a Hotel

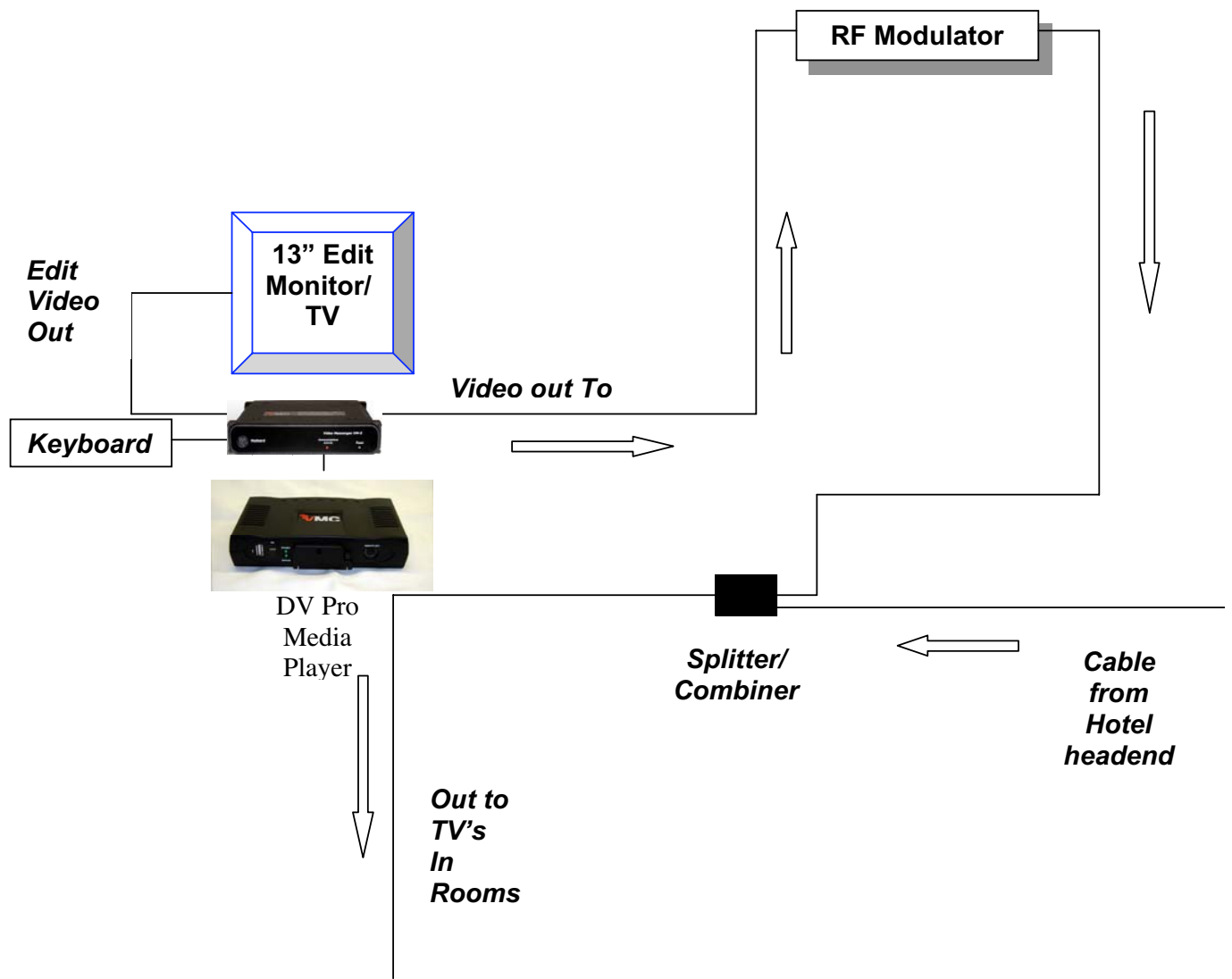

Coaxial cable should be RG-6 Shielded.



Basic Wiring Diagram For Insertion Into Cable Head End or Private Cable System like a Multi-dwelling Unit

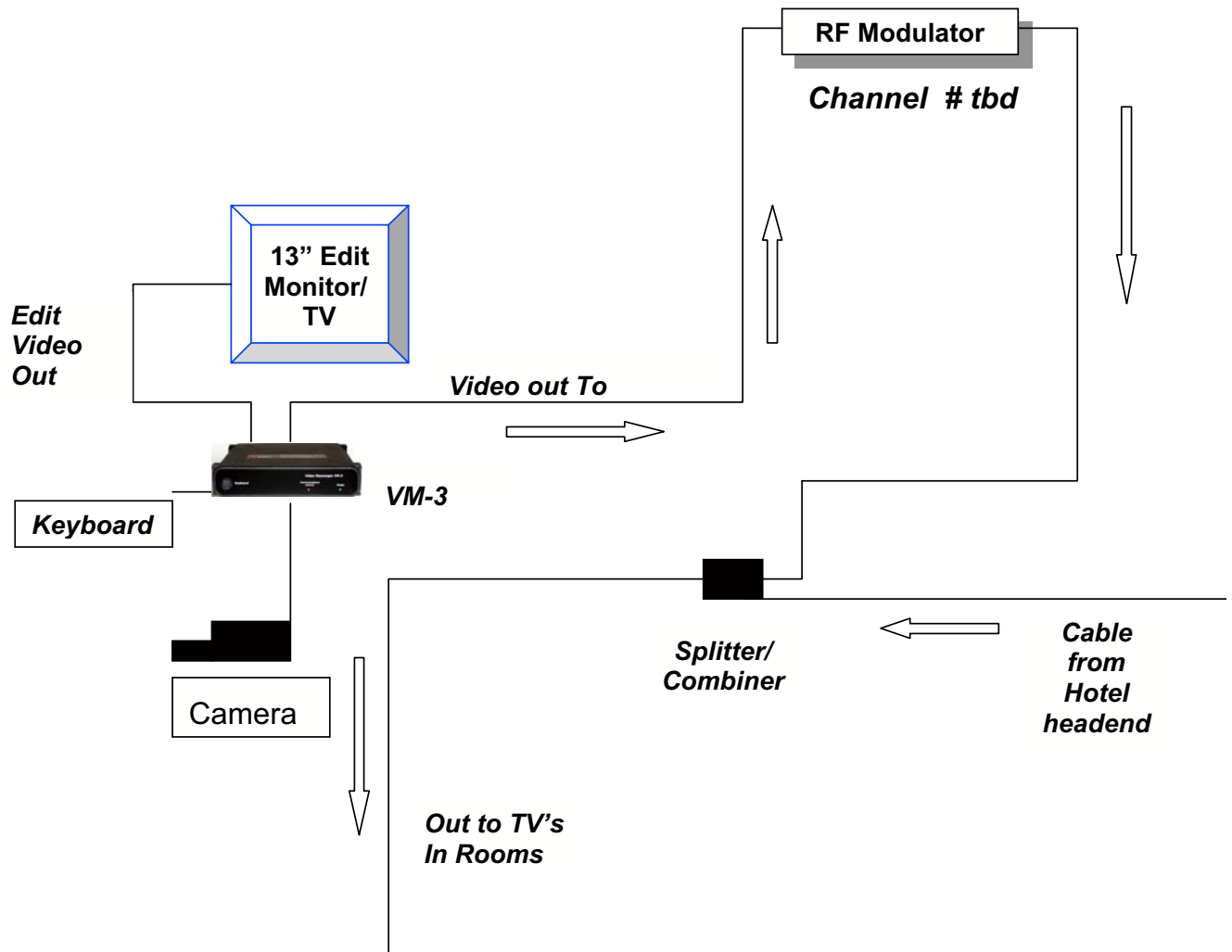

Coaxial cable should be RG-6 Shielded.



Basic Wiring Diagram Video Messenger Modem System

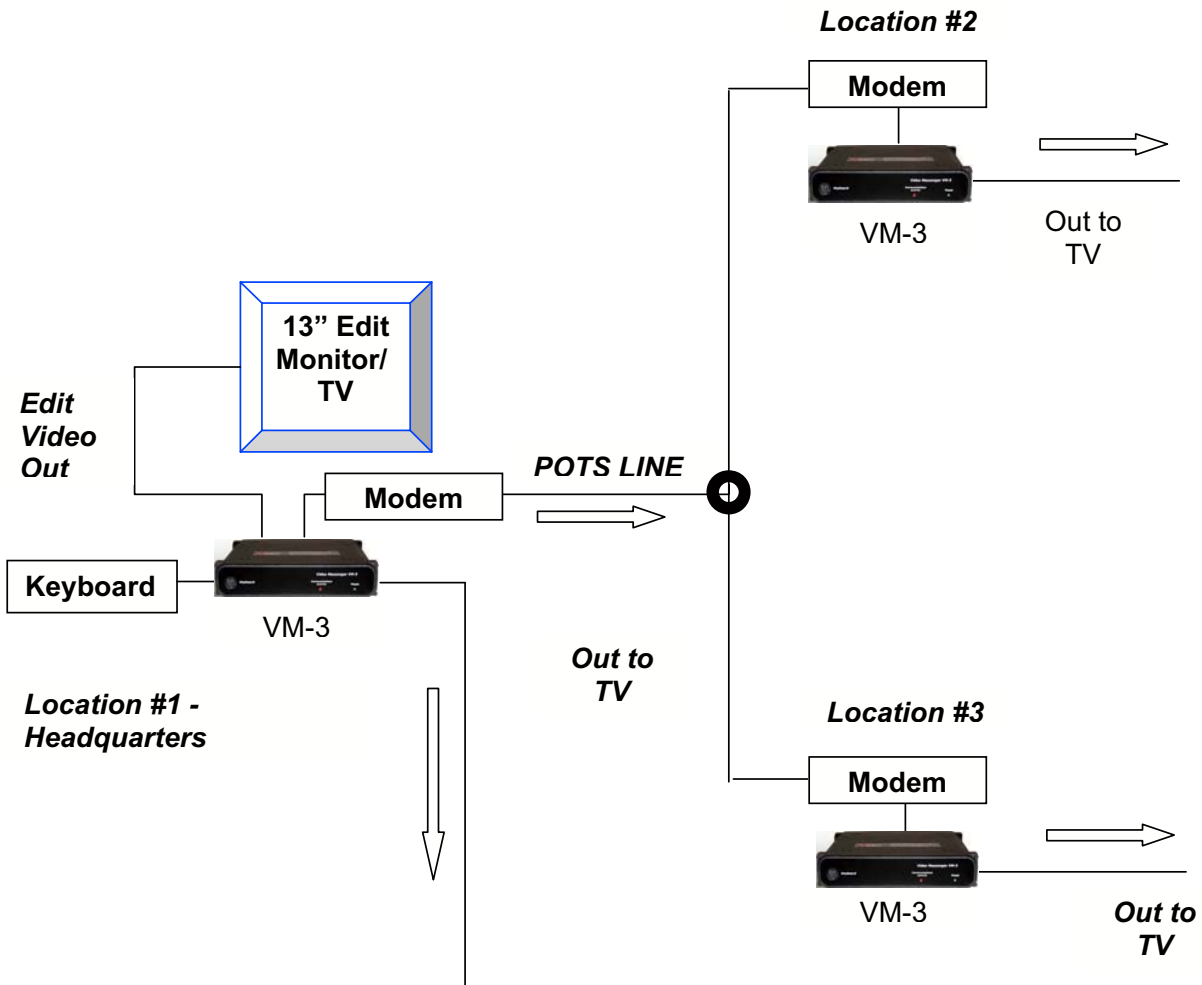

Pots line = Plain old telephone service



Wiring Diagram For Insertion Into Cable System With Tuners At Each TV

Departments with
VMConsole and
Internet Access



General Management



Human Resources



Engineering



Telecommunications

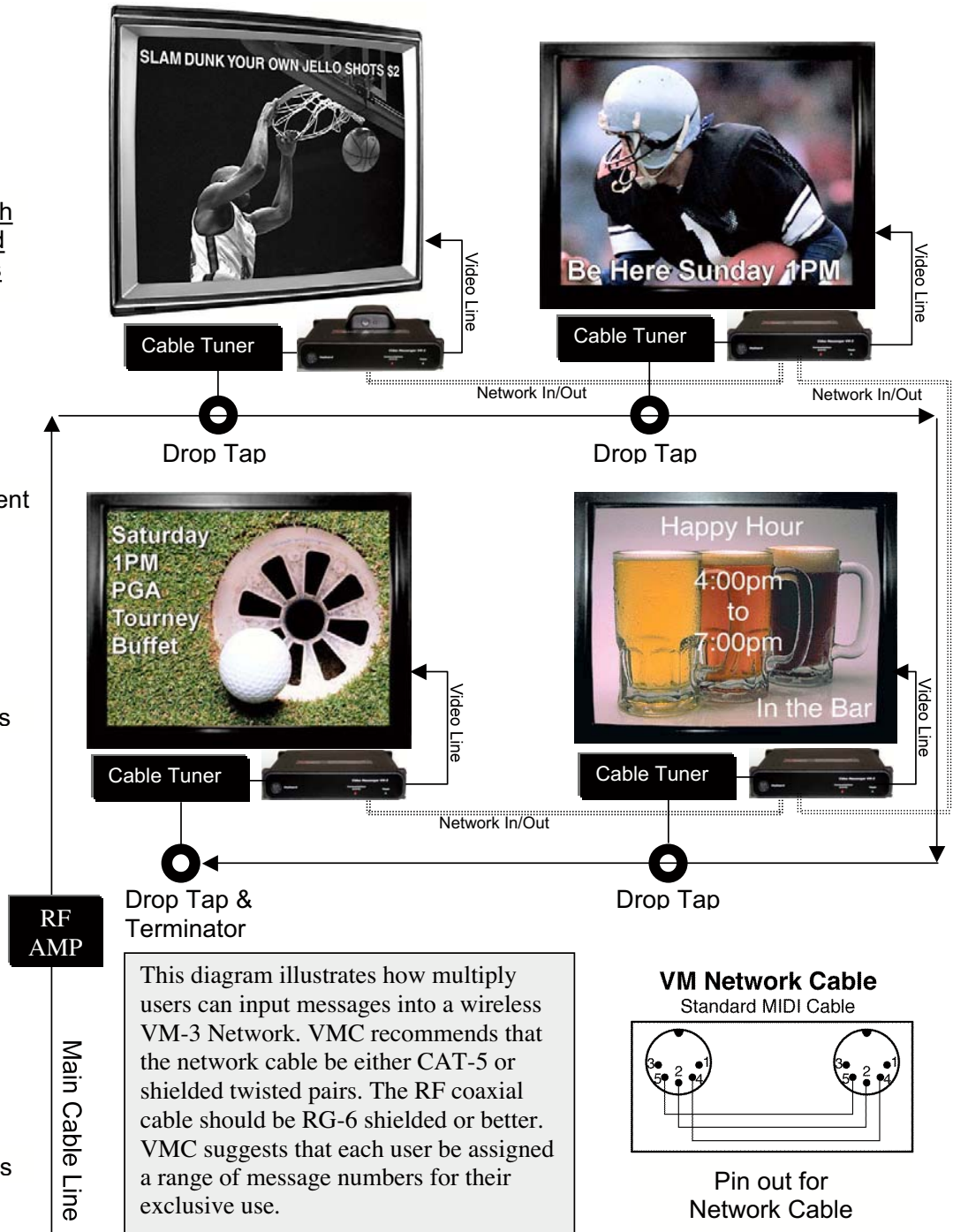

What follows are the most common issues that users call about when they need help with the Video Messenger, VM-3.

1) I get only a blank screen when I try to enter or edit a message.

More often than not, the user is not looking at the video source coming out of the “Video Out - Edit” jack. There are two video outs on the VM-3; one is for editing and one is for display. The display out, the plain “Video Out” jack is suppose to go blank during an editing session so that the viewers (residents, quests, customers, etc.) cannot see what you are doing during the editing session.

The solution to this problem is to make sure that the video you are looking at is coming from the “ Video Out – Edit” jack. This usually means making sure that your TV/Monitor is set to Video as opposed to being set to a TV channel.

2) None of my messages play even though they are saved.

This problem is usually caused by bad clock and calendar settings. If your unit is not on a surge protector and it is subjected to an electrical surge due to lightning or some other cause, the clock can reset to it’s default start date. This setting is 1/1/99, Monday, 12:00 am. If you are using the scheduling menu to schedule your messages, they will be outside the play window because of the bad clock or calendar setting.

The solution is to reset your clock (in the SETUP MENU) and periodically check it to make sure it is correct. A surge protector usually solves this problem permanently.

3) The VMX Pro Media Player is not putting out any Video – all I get is a blue background on the VM-3.

This problem is caused by variety of electrical disturbances or a disconnected video cable.

After checking the video cable, the solution is to turn off the Media Player by holding in the power switch for 5 seconds. With the VM-3 powered up and connected to the video out of the Media Player, power up the Media Player and without the USB Flash Drive attached. Once the Media Player boots up, reinsert the USB Flash Drive. The unit will operate normally after this procedure is completed.

4) The VMX Pro Media Player is not responding to the VM-3. The images are not changing.

This problem is cause by one of two things: 1) The serial cable is disconnected from the Media Player or the COMM A port is not set correctly,

The solution to the first issue is to reconnect the serial cable. The solution to the second issue is to open up the SET UP MENU, tab down to the COMM A port and using your up/down arrow keys set the port to DVD 175 command Set. The Media Player will then respond to the VM-3.