



**BOBCAT OTDR  
USER'S MANUAL**

**Avoid exposure  
Laser Radiation Emitted  
from the aperture.**

*This product conforms to CDRH standards for laser product  
Per 21 CFR 1040.10 & 1040.11*



# Table of Contents

SECTION	PAGE
<b>1.0 OTDR Quick Start</b> .....	<b>1</b>
<b>2.0 Introduction</b> .....	<b>2</b>
<b>3.0 Preparation for Use</b> .....	<b>3</b>
3.1 Inspection	
3.2 Identification / Configuration	
3.3 Power Requirements	
3.4 Laser Safety	
<b>4.0 BOBCAT Description</b> .....	<b>4</b>
4.1 Mechanical	
<i>Enclosure</i>	
<i>Packaging</i>	
4.2 Physical	
Front Panel	
Top Panel	
Display	
<b>5.0 Features Description/Operation</b> .....	<b>6</b>
5.1 Battery Level/Power Indicator	
5.2 Help	
5.3 USB port	
5.4 VFL (Visual Fault Locator)	
<b>6.0 Tool Menu</b> .....	<b>7</b>
6.1 Tool Menu Description	
6.2 Accessing the Tool Menu	
6.3 Tools Menu Functions	
Set Viewable Measurements	
Wavelength Filter	
Pass Code Protection	
Set Splice Zones	
Power Save	
Unit Of Measure	
Cursor Lock	
Baud Rate	
Screen Shot	
Trace Smoothing	
Date Time	
Color Scheme	
Brightness	
Sound	
Set Language	
Enter Calibration	
<b>7.0 OTDR Operation</b> .....	<b>9</b>
7.1 Key Pad Operation	
7.2 Trace Display	
7.3 Auto Test	
Range Finder	
Construction Mode	
7.4 Manual Scan Settings	
Index or Refraction (IOR)	
Wavelength	
Average (AVG)	
Pulse Width	
Range	

7.5	Viewing Trace	
	Zoom Function	
	Zoom Bar	
	Cursor Movement	
	Cursor Lock	
7.6	Loss Measurement	
	Definitions	
	Setting Basic Splice Loss Areas	
	Setting Least Squares Approximation (LSA) Splice Loss Measurement Areas	
7.7	Unit of Measure	
7.8	Quick Save/Recall	
<b>8.0</b>	<b>Event Analysis</b>	<b>15</b>
8.1	Enter Event Analysis Mode	
8.2	Event Table	
8.3	Table Column Definitions	
	# - Event Number	
	P/F - Pass/Fail	
	KM - Unit of Measure	
	Splice	
	2 Point	
	DB/KM	
	Type	
	E – End of Fiber	
8.4	Sensitivity Settings	
8.5	Pass/Fail Setting	
<b>9.0</b>	<b>File Management</b>	<b>18</b>
9.1	Entering File Management System	
9.2	File Management Display	
9.3	Saving a Traces	
9.4	Renaming Traces	
9.5	Viewing Saved Traces	
9.6	Dual Trace/Trace Overlay	
9.7	Marking for Mass Copying or Deleting	
9.8	Copying Traces	
9.9	Deleting Traces	
<b>10.0</b>	<b>Application information</b>	<b>21</b>
<b>11.0</b>	<b>Loss Test Set Description</b>	<b>22</b>
11.1	Entering Loss Test Set Operation Mode	
11.2	Key Pad Operation	
11.3	LTS Display	
	LTS Measurement Screen	
	LTS File Storage Access Screen	
	LTS Zoom Screen	
	LTS Graph Screen	
11.4	Soft Keys	
	Source	
	Power Meter	
	Modulation	
11.5	Loss Test Set Icon List	
	Help	
	Delete	
	Quick File Location	
	Tools Menu	
	View Graph	
	Visual Fault Locator	
	Lambda/Wavelength Select	
	File Download	

<b>12.0 Loss Test Set Operation .....</b>	<b>26</b>
12.1 Power Meter Measurements	
Power Measurements	
Relative Measurements	
12.2 LTS Autotest Mode	
12.3 LTS Light Source Operation	
Energizing Light Source	
Modulating Light Source	
12.4 LTS File Selector	
File selector Screen	
Quick File Locator	
12.5 LTS File Transfer	
12.6 LTS Graph Mode	
<b>13 Maintenance .....</b>	<b>29</b>
13.1 Battery Replacement	
13.2 Clock Battery	
13.3 Laser Out Port	
13.4 Recalibration and Verification	
13.5 OTDR Port Adapter Replacement	
<b>14.0 Specification.....</b>	<b>31</b>
<b>15.0 Warranty / Repair and Trouble Shooting .....</b>	<b>32</b>
13.1 Warranty	
13.2 Repair	
13.3 Trouble Shooting	
<b>16.0 Version Control.....</b>	<b>33</b>





## 1.0 OTDR Quick Start Guide

Press  to turn on the OTDR.

Connect the fiber to the appropriate port.

Press  to enter the Menu mode.

Use the Directional buttons to highlight the  icon on the left side of the display.

Press  to cycle to the desired wavelength. The OTDR will start a scan at the parameters displayed.

### If approximate fiber length is not known:

Press the  button after selecting the wavelength, the Auto Test feature will start and set an appropriate pulse width and range automatically.

### If approximate fiber length is known:

Use the directional buttons to move to:



To set the averaging time - R/T for real-time, Short for a 10 second average time or Long for a 5 minute averaging time.



To set the Pulse width - select 2m for fibers up to 4 kilometers, 10m for fiber up to 16 kilometers, 100m for fibers up to 64 kilometers or 1k for fibers up to 240 kilometers.



Set the range - 1k or 4k for 2 meter pulse width, 4k or 16k for 10 meter pulse width, 16k or 64k for the 100 meter pulse width or 64k or 256k for the 1k pulse width.

To manually start a scan: Press  while the unit is idle.

To stop a scan: Press  while the unit is scanning.

To control the cursors: Press  to exit the Menu mode and use the Directional buttons to move the active cursor.

To view the Event table: Press  to enter Menu mode and use the Directional buttons to highlight the Show

Event soft key and press the  button to change to the event analysis mode.

## 2.0 Introduction

The Bobcat OTDR is the newest in the line of low cost portable Optical Time Domain Reflectometers with the core functions required to measure optical fiber from one end during installation, repair and verification. The Bobcat OTDR is equipped with a 4" TFT color graphic presentation of fiber loss vs. distance, with single wave and Dual wave laser sources. The Bobcat OTDR is packaged in a rugged hand-held case which is further protected with a rubberized boot. All controls are accessible via an 11 key weatherproof membrane keypad with a directional buttons to move through the screen, offering simple, straightforward functionality.

The Bobcat OTDR is capable of measuring 2 point loss, splice loss, loss per/km and event ORL. The singlemode and multimode output ports use high power, 850, 1300, 1310, 1490, 1550 or 1625 nm pulsed laser sources. The backscatter receiver uses a temperature compensated avalanche photodiode for reliable, stable performance in fiber links from tens of meters to over 240Km. A high-speed microprocessor, provides the N-point averaging function and control for <1/4 second Real Time update rates.

The Bobcat OTDR is available with an Auto-Wavelength Switching Power Meter. The power meter is calibrated at the 850,1300,1310,1490,1550 and 1625nm, with storage of up to 10,000 power meter tests. The certification software incorporates a feature to supply loss measurement reports and a real-time graph.

The color TFT LCD display provides a powerful yet simple set of fiber parameters and control indications to view an entire fiber link or zoom in and analyze a splicing point or defect in the fiber. The display shows all or just the desired loss information and offers a preview screen on the file management screen and event preview displayed on the event analysis screen. The fiber loss vs. distance in its central graph is large with easily manipulated cursors. The scales are automatically updated for expansion modes and with position changes of the A and B cursors. Individual and dual cursor measurements are displayed as well as important instrument parameters such as Index of Refraction, pulse width, wavelength, range, scanning speed, and a battery gauge.

The 11 key panel provides simple straightforward commands to take a scan, make measurements or navigate the soft-key and Icon menus. A new scan is accomplished as easily as pressing the Scan button, within 1/4 second fiber trace data is accessible. To automatically adjust for an unknown fiber length, press the Auto Test button. The soft-key menus are navigated pressing the menu button and use the directional buttons to move to the soft key bar located at the bottom of the display. Instrument setup is easily accomplished with the use of the Icon menu also located at the bottom and bottom sides of the display.



### 3.0 Preparation for Use

#### 3.1 Inspection

Before shipment, this instrument has been inspected and found to be in perfect working order and free of defects.

**The shipping carton should contain the following:**

OTDR, with protective boot and 4-AA NiMH batteries installed	Universal AC/DC charger with interchangeable mains
CD with Windows™ compatible software	USB cable
Set of interchangeable adapters, ST/SC and FC Adapters for each OTDR port and for the Power Meter Port	Hard Copy Manual

#### 3.2 Identification/Configuration

The instrument's Model, Part Number, Serial Number, Date of Manufacture and Configuration are indicated on a label located on the back of the unit. The instrument's history is filed at the factory by part number and serial number.

#### 3.3 Power Requirements

The instrument is equipped with a 100-240V-0.4A input universal battery charger with 9V, 0.66A, center positive output AC/DC charger that is supplied with interchangeable mains for US, Great Brittan, Europe and Australia which recharges the unit's internal NiMH batteries (4 - AA, 2500mA hours). Depending on usage, fully charged battery pack will typically enable 4 hrs of use. Typical fully discharged batteries require 6 - 8 hours of recharging. For best results let charge overnight. (For extended battery life, do not leave battery on charger indefinitely.)

To replace the batteries, remove the OTDR from the protective boot by pulling the bottom of the boot down and back allowing the unit to be removed. The battery door is located on the back side of the unit. Replace the batteries only with AA NiMH batteries. Spare battery packs are available with a charging unit for extended battery operation. If you install NiMH batteries that are dead or less than 1 volt each, charge these batteries for one (1) hour before using the Bobcat OTDR. For maintenance, batteries require a monthly periodic recharge.

**WARNING:** To Prevent Fire or Shock Hazard: Do not install other battery types; Do not use the charger without the batteries installed; Do not expose the battery charger to rain or excessive moisture; Do not use the AC adapter when there are signs of damage to the enclosure or cord; Ensure that you are using the correct charger for the local line voltage; Do not use any other charger than the one provided with this instrument. Any other condition will void the warranty.

#### 3.4 Laser Safety

The VFL is equipped with a 650nm Class II laser. See warning label figure 3.1.

The OTDR has been configured with laser diodes having central wavelengths of 850nm, 1300nm, 1310nm, 1490, 1550 or 1625nm. The unit has been designed to comply with 21 CFR (Code of Federal Regulations) 1040.10 and 1040.11, for Class I emission limits. Although the CDRH does not consider Class 1 levels to be hazardous, we suggest limiting exposure by not looking directly into the laser aperture. Also, **do not under any circumstance** view or inspect the laser output fibers, connectors or the fiber under test through collimating or focusing optics unless the unit is turned off, batteries are removed and power adapter is disconnected.

**WARNING:** Never clean or look directly into the fiber optic connector or the end of fiber attached to the OTDR or VFL unit while they are energized, to do so will expose the user to laser radiation and could result in personal injury or instrument damage.

**WARNING:** Before connecting to a patch cord or fiber under test, be certain the fiber has no active optical sources or instruments connected to the other end. Skin or eye damage could result from other high power sources e.g. EDFAs, or instrument damage could occur voiding the warranty.

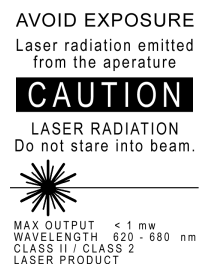

Fig. 3.1

## 4.0 BOBCAT Description

### 4.1 Mechanical

#### Instrument Enclosure

The Bobcat OTDR is packaged in a rugged housing which is further protected with a rubberized boot. Although the front panel is weather resistant, care must be taken to avoid liquids and contaminants around the fragile optical, electrical connectors, and the glass display. Use a mild cleaning agent and damp soft cloth to clean the panels and the outside case. See the maintenance section to clean the optical connector. NEVER open the instrument for cleaning. Return to the factory for servicing if necessary.

#### Bobcat OTDR Packaging

The instrument is shipped in a protective cardboard container, universal charger with interchangeable mains, FC/ST and SC interchangeable fiber adapters, USB Cable, and a CD with Windows™ compatible software, and this manual. Save the protective packaging for storage and shipment.

### 4.2 Physical

#### Front View



Fig 5.1

## Physical (continued)

### Top Plate

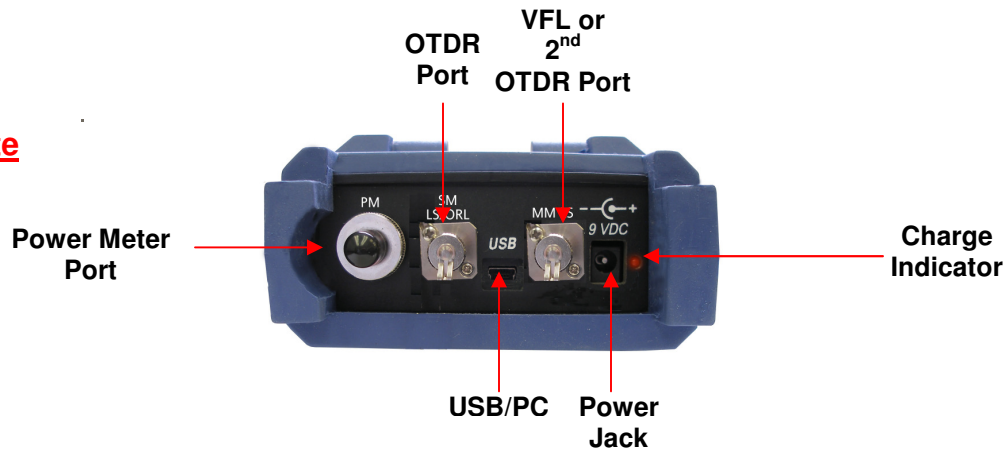

Fig 5.2

### Display

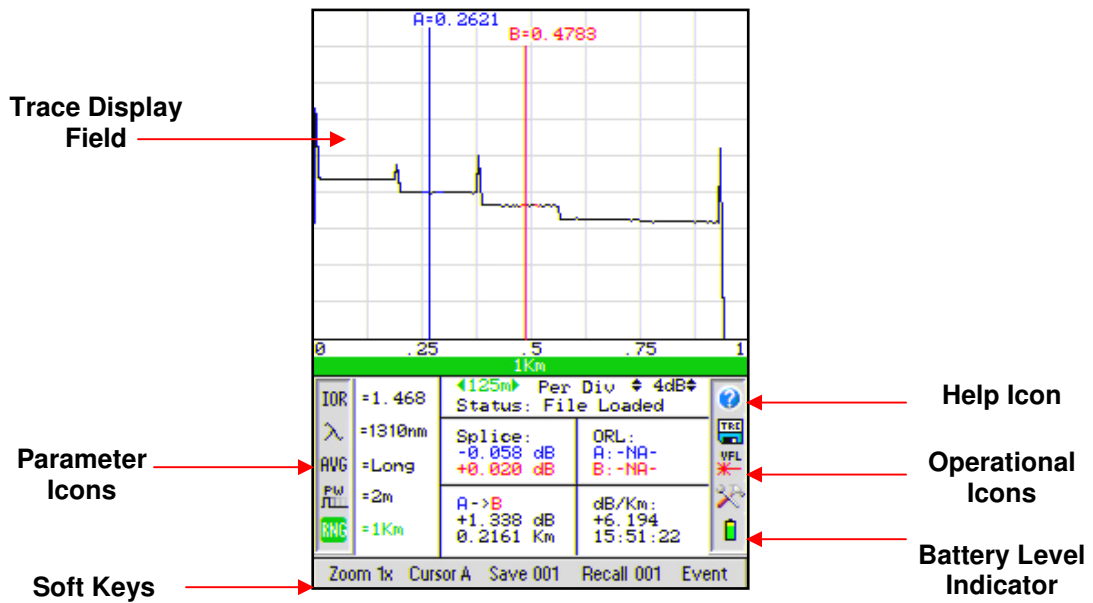

Fig 5.3

## **5.0 Feature Description/Operation**

### **5.1 Battery Level/Power Indicator**

The bottom right hand corner of the screen shows the battery level and charge indicator. In the final hour of operation the battery will change to red. A warning indicator will sound a few minutes before the instrument automatically turns off. Ensure the unit is turned off when plugging in the Battery Charger. When the OTDR is plugged in the AC power, the charge indicator will be lit (Fig 5.2). The charge indicator will dim when the battery is fully charged. Also, the battery indicator section on the display (Fig 5.3) will display an AC Plug alongside the battery when operating on AC power.

### **5.2 Help Feature**

The Bobcat OTDR has an onboard help feature. To access the help feature, press the Menu button use the directional buttons to highlight the Question Mark icon and press the Select button. Use the directional buttons to move to the desired topic and press the Select button. Use the directional buttons to move down the help page if necessary. Press the Menu button again to exit the help feature.

### **5.3 USB Port**

Located on the top panel is the USB/PC port which is used to connect the OTDR to a computer to download stored data for analysis with the supplied Windows™ compatible software.

### **5.4 VFL**

The Visible Fault Locator (VFL) is a stabilized fiber optic laser source that emits visible (red) light at 650nm. Its intended function is to allow an operator to identify the exact location of a break, micro bend, or other discontinuity in a fiber optic cable. As the radiation is visible, light emanating from a break or micro bend enables the user to locate the exact position of a fault even at very short distances that would not be detectable by other means. It is also useful for identifying a particular fiber in a cable by exciting the fiber to be located with visible radiation. To use the VFL, press the Menu button and use the directional buttons to highlight the VFL icon, press the Select button to cycle the VFL through CW (constant wave) mode or modulated mode and Off.

## 6.0 Tools Menu

### 6.1 Tools Menu Description

Although many settings for the Bobcat are set as the user operates the unit, there are a number of settings that may be made to increase the ease of use for the OTDR. Many of these settings are located in the Tools menu.

### 6.2 Accessing the Tools Menu

To access this menu, press the Menu button and use the directional buttons to highlight the Tools icon. Press the Select button and the Tools Menu dialog will be displayed. Use the directional buttons to highlight desired function. To exit the Tools Menu, press the Menu button.

### 6.3 Tools Menu Functions

#### Set Viewable Measurements

The Bobcat OTDR allows the user to set which loss measurements to be displayed. The available loss measurements are splice loss or Least Squares Approximation (LSA) splice loss for both cursors, dB value between cursors, distance between cursors and dB per Km or Kf. If any of these measurements are not of necessary for a series of test, one or more may be turned off for ease of viewing. To accomplish this, open the tools menu, highlight View Icon and press Select. A box will be drawn around the splice loss measurements. Use any Directional button to cycle the measurement between LSA Splice, Basic Splice Loss, or off. Press Select to move to the next measurement. The remainder will just toggle between off and on by pressing any directional button. Continue through the four measurements and the Tools menu will be returned to the screen when select is press on the last measurement. After setting db/km pressing select will return focus to the Tools menu dialog. Pressing The Menu button at any time will close the Tools menu.

#### Wavelength Filter

Wavelength Filter allows the user to turn on and off wavelengths as desired for OTDR testing. To accomplish this, highlight Wavelength Filter and press Select. Scrolling to a wavelength and pressing Select will toggle a wavelength off and on.

#### Pass Code Protection

The BOBCAT may be protected from unauthorized use with a 4 digit pass code. Enter the Tools Menu, use the directional buttons to move to the Pass code Protection tool and press the Select button. Use the Directional buttons to set the first digit from 0 to 9 and press Select. Continue until all four positions are entered. Pressing Select on the last digit will move the focus to "Enter" or "Cancel" press Select again set the pass code or use the Directional buttons to highlight Cancel and press Select to abandon any changes. Contact FIS technical support if your code is lost, for a master pass code.

#### Set Splice Zones

Refer to section 7.6 for full instructions on set Splice Loss Measurement Areas.

#### Power Save

The Bobcat OTDR incorporates a Power save feature that allows for maximum utilization of the battery life. If set to ON, the unit keeps track of the keypad activity and if no key presses are detected for a period of approximately 15 minutes, the unit will automatically turn itself off, storing the current mode settings. To turn the feature on or off, highlight the Power Save tool and press the Select button.

#### Unit of Measure

To toggle between Kilometer (Km), Kilo feet (Kf) or Mile (Mi), press Select button while the Unit of Measure tool is highlighted.

#### Cursor Lock:

The OTDR cursors may be locked for accurate measurements. To lock the cursors, use the directional buttons to highlight the Cursor Lock tool and press the Select button to toggle the feature on or off. In the lock cursor mode, with the A cursor as the active cursor, both A and B cursors move together and with the B cursor as the active cursor, the B cursor will move independently in order to set the distance between the two cursors.

### Baud Rate

It is necessary to set a com port speed for communication with a computer, to set the baud rate, highlight the COM Baud Rate tool, press the Select button and a dialog with the available settings is displayed. Use the directional buttons to select baud rates from 115k to 921k. Press the Select button again to select the baud rate and close the dialog.

### Screen Shot

This feature is not available.

### Trace Smoothing

**Note: Smoothing is NOT meant to be used when using the Event Table. Smoothing will smooth the trace for visual interpretation and may cause excess events the event table. Reflective events could be adversely affected in noisy environments.**

Smoothing helps reduce noise in a trace to better visually discern events. To set Smoothing levels or to turn Smoothing off, highlight the Trace Smoothing tool, press the Select button and a dialog will be displayed allowing the choice of turning off smoothing or setting it to minimum (Min) or maximum (Max). Use the directional buttons to select desired level and press Select. Smoothing effect is processed after the scan is completed. A minimum scan time of 10 seconds (Short Scan) is required for smoothing to be accomplished. If a long scan is interrupted after 10 seconds the smoothing will be accomplished. Minimum smoothing is instantaneous with a lesser effect. Maximum smoothing requires approximate 1-2 seconds to complete.

### Date/Time

The OTDR applies a time/date stamp to the saved files. The time and date are set at the factory with a MM/DD/YY date and 24 hour format clock. To change the date and time, Highlight the Time/Date tool and press the Select button. A dialog box with the settings will be displayed. Use the directional buttons to change each segment, use the Select button to move between segments and then to Save/Redo/Cancel. Use the directional buttons to select Save, Redo or Cancel then press the Select button again to complete the process.

### Color Scheme

To change the color scheme press the Select button while the Color Scheme tool is highlighted and the display will cycle through the six preset color schemes.

### Brightness

The Display has a high and low brightness setting. To toggle between the two settings, highlight Brightness tool and use the Select button to toggle between the two settings.

### Sound

The speaker may be turned on or off as desires. To toggle sound on and off, highlight the Sound tool and use the Select button to toggle the sound on and off.

### Set Language

Press the Select button to toggle between English and Chinese.

### Enter Calibration

This tool is for factory use.

## 7.0 OTDR Operation

### 7.1 Key Pad



Power button, turns the unit On and Off. (Hold for 1 second)

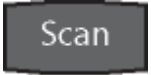

This key will start a scan or stop the current scan.



Fig 7.1

This key operates Range Finder or Construction Mode. The Range Finder mode momentarily checks test conditions and starts a scan at the wavelength selected by the user but allows the OTDR to determine the pulse width and range parameters. This test will flash Auto in the Pulse Width and Range settings until the instrument has determined the best setting and displays the test parameters on the display. The Construction Mode is used to automatically save and display dual traces. The first time Autotest is press upon power-up, a dialog box will display to set the function of the button. To change the function once set in a user session, press and hold the Autotest button and the dialogue box will be displayed again.



Toggles between the Trace Mode where the focus of the directional buttons and the Select Button are on the active cursor and the Menu mode where the directional buttons moves through the Soft Key Menu and the Icon Bar.



Toggles between A and B as the active cursors.



Selects the Zoom level, each press increments through the levels of 1x, 2x, 4x, 8x and 16x.



While in Trace Mode the Select button will move the "Active" cursor to the next event. While in Menu Mode, the Select button actuates highlighted item.



While in the trace mode the directional buttons are used to move the cursors and while in the Menu mode, the focus of these buttons is placed on the movement between icons or used to change settings.

## 7.2 Trace Display

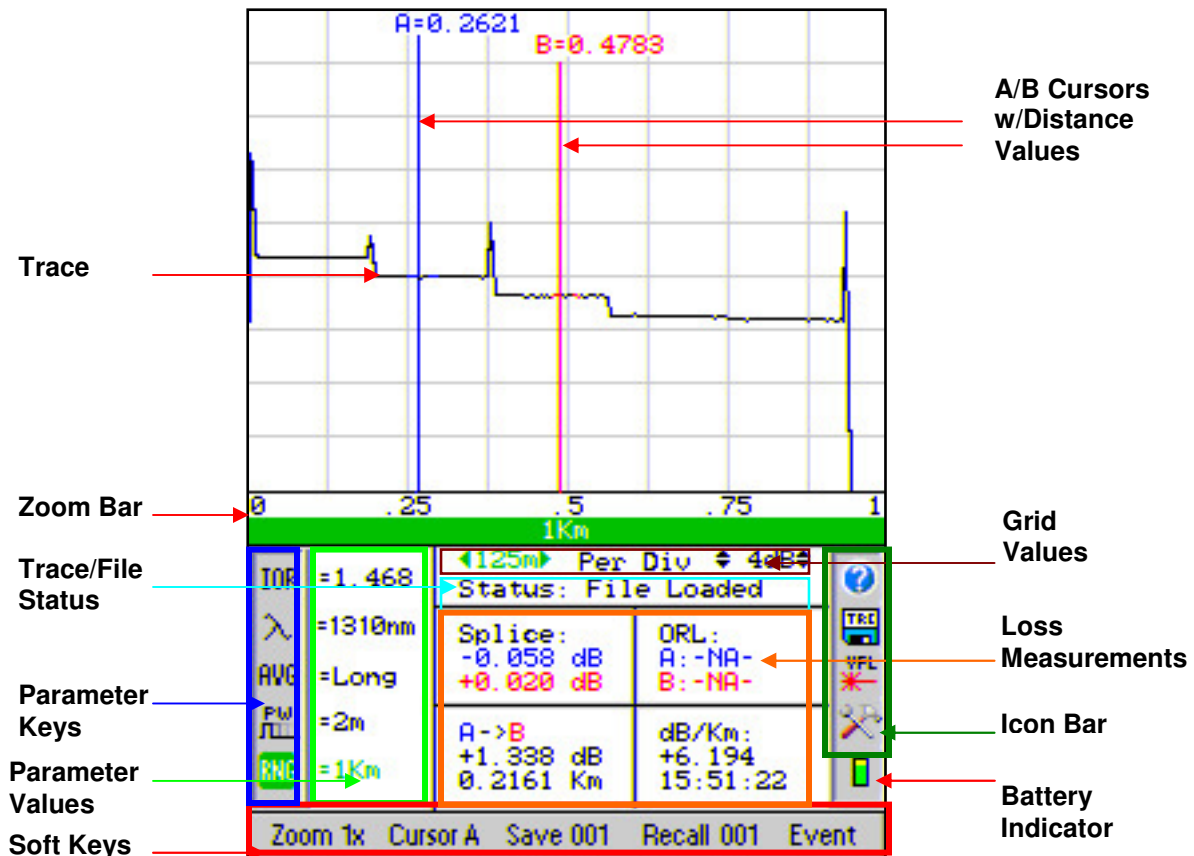

Fig 7.2

**WARNING:** Before connecting to a patch cord or fiber under test, be certain the fiber has no active optical sources or instruments connected to the other end. Skin or eye damage could result from other high power sources e.g. EDFAs, or instrument damage could occur voiding the warranty.

**WARNING:** Clean connector thoroughly prior to connection to the appropriate port of the OTDR. Failure to ensure the connectors used with the OTDR are properly cleaned can result in poor launch conditions at the minimum or damage that requires the unit be returned to the factory for repair.

## 7.3 Auto Test

### Range Finder

This is a useful feature when the approximate length of the fiber to be tested is unknown. To conduct a Range Finder test, press the Autotest button.

The first time Autotest is pressed upon power-up, a dialog box will be displayed to set the function of the button. Use the directional buttons to move between the Range Finder and Construction Mode. Press the Select button once the desired function is highlighted. To change the function once set in a user session, press and hold the Autotest button and the dialog box will be displayed again.

For Range Finder mode, set the wavelength to be tested. To set the wavelength, press the Menu button, move to the Lambda icon and use the Select button to cycle to the desired wavelength. Press the Autotest button, the unit will set the average time to short, starts a scan and flashes Auto in the pulse width and range parameters. When Auto stops flashing the unit has set the pulse width and range and completes the scan.



### Construction Mode

This is useful when a large number of fibers need to be tested with the same settings at multiple wavelengths.

To operate in Construction mode, set the Autotest button to this mode as described above. The Construction Mode tests up to two wavelengths at one time, displays the two traces and saves the traces to the next two available storage locations.

Follow these procedures to test in Construction mode:

#### Set The Wavelengths:

Set the wavelengths to be tested by pressing the Menu button, use the directional buttons to highlight the Tools icon and pressing Select. Use the directional buttons to highlight the Set Wavelength Filter tool and press Select. Grayed out wavelengths are turned off. The wavelengths in black text are active. To shut off or turn on wavelengths, use the directional buttons to highlight the wavelength and press the Select Button. To complete the process, use the directional buttons to highlight Save and press select. Press Menu again to close the Tools dialogue box.

#### Set Test Parameters:

Check the Average Time, Pulse Width and Range to ensure they are set properly. Refer to section 7.4 for instructions on setting these parameters.

**Note:** Real Time is not recommended as an averaging time for Construction mode.

#### Set The File Name:

It is necessary to set the base file name prior to starting the test. To establish the file name, press the Menu button, use the directional buttons to highlight the File Management icon and press Select. Scroll to a Free file location at the beginning of the section with enough empty storage locations to save all the files for a set of tests and press Select. Name the file by using the directional buttons to display the desired letter or number and press Select to move to the next Character. Do not press select to enter the last character. Once it is displayed, press the Menu button and Save Changes soft key will be highlight, press Select or use the directional buttons to highlight Discard Changes and press Select. All future files will use the new base file name until it is change. The file that was just created may be deleted if desire by following the procedures in section 10.9.

#### Set Default Notes:

To enter default notes for trace files, enter File management as above and use the directional buttons to highlight any empty or Free location. Press the Menu button, use the directional buttons to highlight the Notes soft key and press Select. The first Character of the note box is highlighted. Use the directional buttons to display the desired character and press select. Continue on until the note is complete. To erase the characters and move forward, use the "blank". To quickly return to the beginning of a note, press the Menu button and then the Select button on the Notes soft key. To exit the Notes box, press the Menu button. This note will now be the default note for all traces until it is changed or removed. To remove notes, Press Select on the "blank" character until all characters have been removed.

#### Conduct The Tests:

Connect a fiber to the proper test port and press the Autotest button. The OTDR will conduct the test at the first wavelength and store the trace in memory using the base file name given, and the default notes attached. The second wavelength is then started and once complete it is also stored to memory and then both traces are displayed for review.

Disconnect the fiber, connect the next fiber and press Autotest. The two tests will be completed stored and displayed. Continue on until all fibers are tested.

## 7.4 Manual Scan Setting

After powering on the OTDR, Enter the menu mode by pressing the Menu button and use the directional buttons to move to the parameter keys on the bottom left side of the display to set the test parameters to the appropriate values.

## These parameters include:

### IOR:

It is necessary to have the Index of Refraction set as close as possible to the actual IOR of the fiber. If this is unknown it is best to use the default setting on the OTDR. To change the IOR, highlight the IOR icon and press the Select button. Use the directional buttons to change the IOR value. When the desired value is reached, press the select button again and the OTDR will prompt the user to save or cancel the changes. Use the directional buttons to highlight desired action and press the Select button.

### Wavelength:

Use the directional buttons to highlight the Lambda key, press select to cycle through the available wavelengths.

### AVG:

Use the directional buttons to highlight the Average (AVG) icon and use Select button to cycle through, Real-time averaging, with a up to 4 pps refresh rate, Short average (~12 seconds) or long average (~5 minutes). Changing this setting will also initiate a scan.

### Pulse Width:

Use the directional buttons to highlight the PW icon and use the Select button to cycle through the pulse widths of 2m, 10m, 100m, and 1k. Making changes to the pulse width, automatically changes the range setting to ensure proper measurement parameters are maintained, example, if the unit is in short range at 2 meters, when the pulse width is changed to 10m, the range will change to (4Km) which is the short range for the 10m pulse width. Changing this setting will also initiate the scan process.

### Range:

Use the directional buttons to highlight the RNG icon and use the Select button to toggle between the two ranges available per pulse width. Changing this setting will also initiate the scan process.

## 7.5 Viewing a Trace

### Zoom

There are five zoom levels, 1x, 2x, 4x, 8x and 16x. The current level is indicated next to the soft button at the top of the display. There are two methods to change the zoom level. The soft key on the top of the display may be used to cycle through the zoom levels by entering menu mode, use the directional buttons to highlight the Zoom soft key and using the Select button to cycle through the zoom levels or simply pressing the Zoom Button.

**Note:** The values per division change with each change of the zoom level.

### Zoom Bar

At the bottom of the trace is a Zoom Bar. This represents the entire range of the trace being viewed. The green portion within the area represents the amount of the trace that is being viewed while the zoom function is being used. In zoom level 1 the green portion will fill the zoom bar area meaning the entire range of the trace can be viewed and in Zoom level 2 the green bar will fill only half of the zoom bar area, meaning half of the entire range of the trace can be viewed. As the zoom levels increase, the green zoom bar will decrease in size to indicate the amount of the trace that can be viewed at one time. As a cursor is moved with the directional buttons, the green zoom bar moves to indicate what portion of the trace is being seen. For example, if the green bar is to the left of the zoom Area, the beginning portion of the trace is being viewed and if the green bar is to the right of the zoom Area, the end of the trace is being viewed.

### Cursor movement

The current active cursor is indicated next to the soft key at the bottom of the display. There are two methods to change the active cursor. The Cursor soft key on the bottom of the display may be used to change the active cursor. Enter the menu mode with the Menu button and use the directional buttons to highlight the Cursor soft key and use the Select button to toggle between active cursors. The second method is to use the A/B button on the front of the OTDR to toggle between cursors.

**Note:** To quickly move the active cursor to the next event, press the Select button while the unit is in the trace view mode.

### Cursor Lock

The cursors may be locked for accurate measurements. To lock the cursors press the Menu button, use the directional buttons to move to the Tools icon and press the Select button, use the directional buttons to move to the A/B icon and press Select to toggle the lock cursor mode on and off. In the lock cursor mode, with the A cursor as the active cursor, both A and B cursors move together and with the B cursor as the active cursor, the B cursor will move independently in order to set the distance between the two cursors.

## 7.6 Loss Measurements

### Definitions

- 2 Point loss method takes the difference in vertical height between where the A and B cursors cross the fiber trace to determine loss.
- The dB/Km (dB/Kft) loss method takes the 2 Point loss in dB and divides by the distance between the cursors in Kilometers (Kilo feet). For accurate dB/Km (dB/Kft) loss measurements, the two cursors must be on level backscatter points at least 100m apart (NA will show for distances that are too short).
- Basic Splice Loss method takes the loss around cursor A and B. The averaged areas before and after the splice must be level backscatter, free from defects or splices. Set a cursor at the beginning of an event and set splice loss measurement areas as directed below for accurate splice loss measurements.
- Least Squares Approximation (LSA) Splice loss method gives the use a visual aid in setting splice loss areas. This method can be more accurate by affording the ability to see the slope of the splice loss areas, however: it can also supply a reading with greater error if not used properly. The splice loss lines must be set to overlay the backscatter of a trace without over lapping any other events.

### Setting Basic Splice Loss Measurement Areas

The splice loss areas around the cursors are adjustable. This is accomplished by entering the Menu mode and using the directional buttons to highlight the SPL Icon. Press Select and the focus of the directional buttons changes to the splice loss measurement area before and after the "Active" cursor. It is necessary to set these areas in clear backscatter to acquire the most accurate measurements. The measurement areas can not include other events such as reflective or splice events. The measurement area may be expand or decreased by using the Select button to toggle through the trailing end of the measurement area before the cursor or the leading and trailing ends of the measurement area after the cursor. The selected point is indicated by an arrow and the size may be changed with the use the directional buttons. To escape this mode press the Menu button again and the focus will be back on the menu bar.

### Setting Least Squares Approximation (LSA) Splice Loss Measurement Areas

The splice loss areas around the cursors are adjustable. This is accomplished by entering the Menu mode and use the directional buttons to highlight the View Icon. A box will be drawn around the splice loss measurements. Use the Directional buttons to toggle the measurement between Splice Loss, LSA Splice Loss or off. It is necessary to set the LSA areas in clear backscatter to acquire the most accurate measurements. The LSA areas may be expanded, decreased or moved along the backscatter area adjacent to the event. The areas should not include other events such as reflective or splice events. A line is displayed to assist with setting the proper LSA areas. The LSA areas are set properly when the LSA lines overlay the back scatter sections of the trace before and after the event. To set the LSA areas, press the menu button, use the directional buttons to move to the SPL icon and press the Select button. The focus of the Directional buttons is now on the LSA areas. The position of the area that is being changed is indicated by the Blue arrow floating above the trace. It is also indicated as a green section on the cursor. To move to the next LSA adjustment point, use the Select button. When finished setting the LSA area, press the Menu button to return to Menu Mode or press it a second time to return to the trace mode. Please see Fig 8.3 for examples of proper LSA settings. In Noisy environments the LSA Lines will have an exaggerated movement making the Basic Splice Loss Measurement potentially more accurate. Please see the following examples:

## LSA Examples

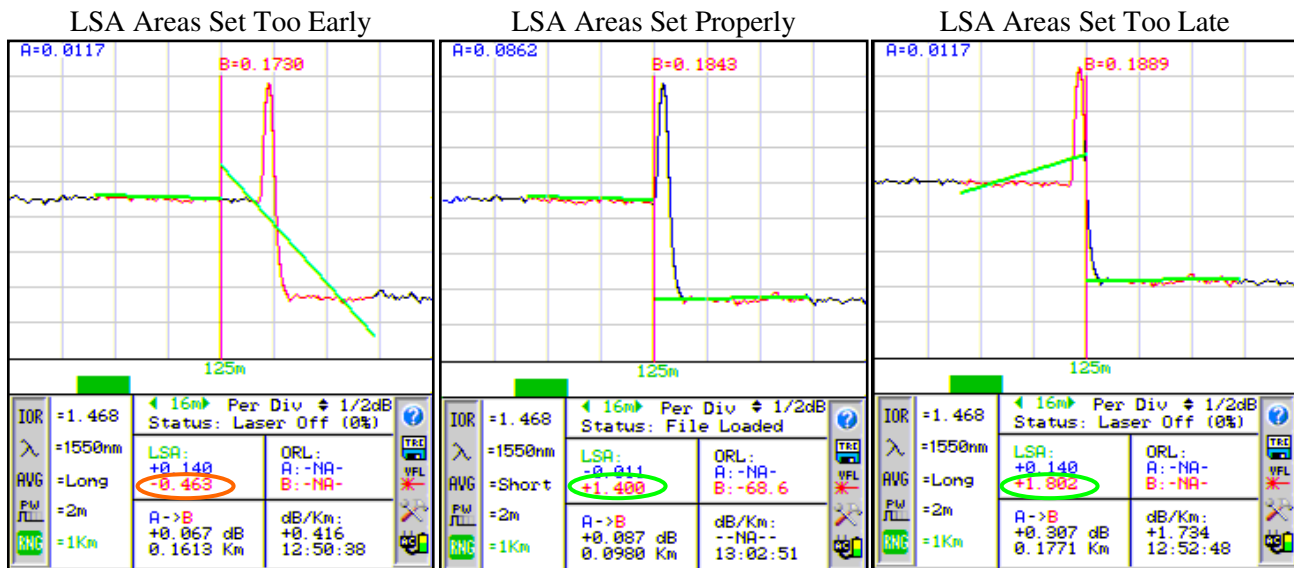

B Cursor LSA -0.463

B Cursor LSA +1.40

B Cursor LSA +1.802

The LSA area and cursor are set too early. The right most green LSA indicator line is not overlaying the back scatter of the trace properly. The scale here is 1/2 dB per grid division. This event should show a loss of approximately +1.40dB.

The LSA area and cursor are set properly. The green LSA indicator line is overlaying the back scatter of the trace properly. The scale here is 1/4 dB per grid division.

The LSA area and cursor are set too late. The left most green LSA indicator line is not overlaying the back scatter of the trace properly. The scale here is 1/2 dB per grid division. This event should show a loss of approximately +1.40dB.

Fig 7.3

### 7.7 Unit of Measure

The distance unit of measure may be either displayed in Kilometer (Km), Kilo feet (Kf) or Miles (Mi). To change the setting, enter the menu mode, use the directional buttons to highlight the Tools icon and press the Select button. Use the directional buttons to move to Unit of Measure and use the Select button to toggle between Km and Kf. Press the Menu button to return to the trace display.

### 7.8 Quick Save/Recall

#### Quick Save

To use quick save, press the Menu button, use the directional buttons to move to the Save soft key and press the Select button. The trace will be saved to the storage location shown. The file will be stored with the same base file name as the last save stored trace. If the storage location indicated already contains a file, the user will be prompted to either "Overwrite" the location, Save to the "Next" available location or "Cancel" the action. Use the directional buttons to move to the desired action and press Select. The storage location will increment accordingly.

**Note:** There are sample traces stored on the OTDR at the factory. These traces are saved with the base file name of default.

#### Quick Recall

To quickly recall a trace, press Menu, use the directional buttons to move to the Recall soft key and press the Select button to display the trace that is saved in the memory location indicated and the next memory location with a trace will then be displayed.

## 8.0 Event Analysis

**NOTE:** When using the event table, it is necessary to keep in mind that event analysis provides approximate loss and distance measurements to quickly assist in network evaluation. Automatic detection results are not guaranteed and have their limits, possibly causing erroneous readings or detection failure. User interaction by interfacing with the trace display is recommended for final qualitative and quantitative analysis.

### 8.1 Enter Event Analysis Mode

To open the event analysis table, press the Menu button, use the directional buttons to highlight Show Event soft key and press the Select button. Use the Directional buttons to move through the events. If the Select button is pressed while an event is highlighted, The OTDR will revert to the Trace Screen with the active cursor positioned at the selected event. An alternative method to return to the trace view is to press the Menu button, use the directional buttons to move to the Show Trace soft key and press the Select button.

### 8.2 Event Table Display

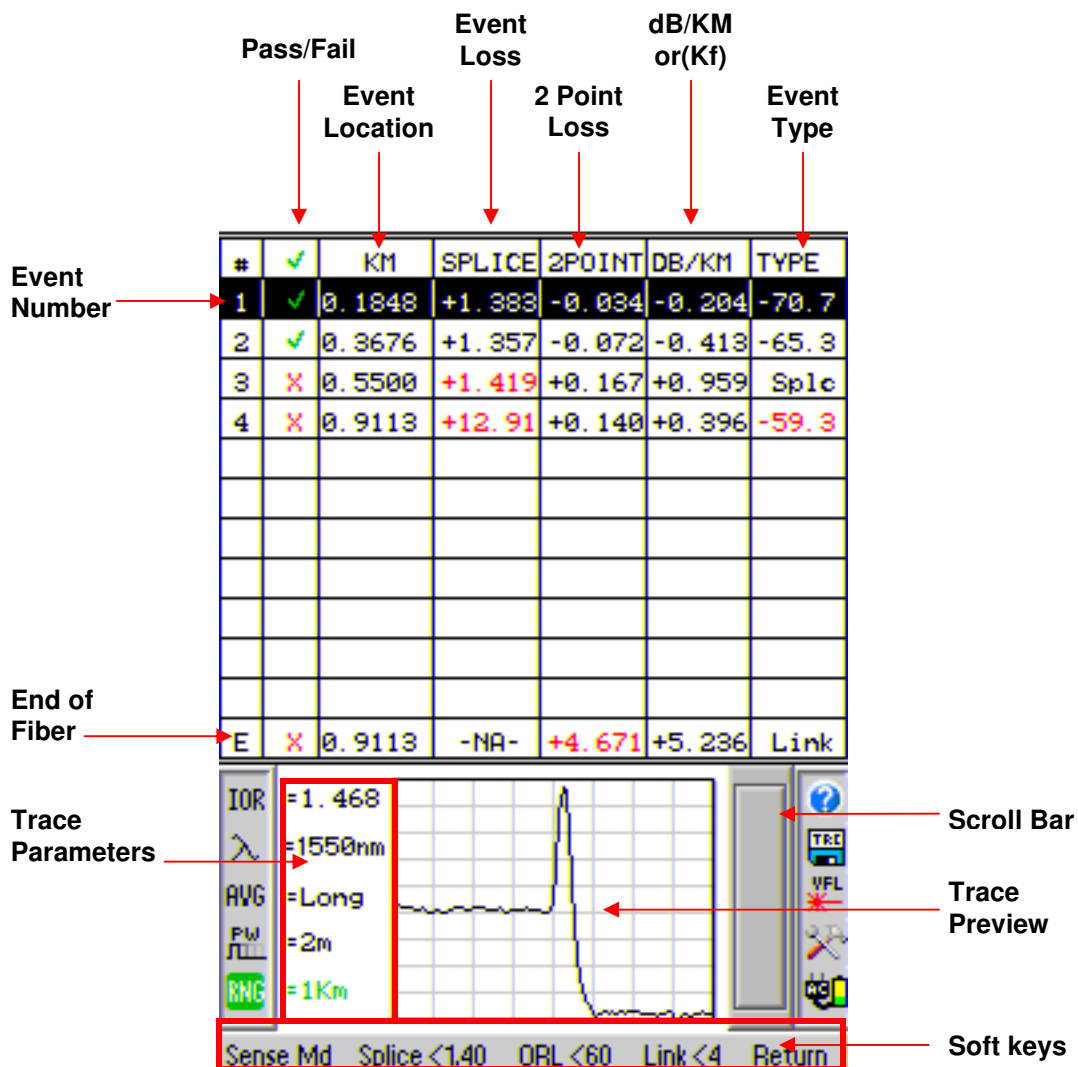

Fig 8.1

### 8.3 Table Definitions

#### # Event Number

Indicates the event in sequence, where the higher the number the further distance from the OTDR the event occurs. "E" which is always displayed in the bottom row is the event determined to be the End of Fiber (EOF).

#### P/F

Pass/Fail, if any one of the thresholds are not met for an event, the P/F column will display a red X. The parameter that failed will also be displayed in red. If all the parameters are met, a green check mark will be displayed.

#### KM

Event Location, Km for Kilometer or KF if unit of measure is Kilo-feet MI for mile. This is the distance/location that the event occurs in the respective unit of measure.

#### SPLICE

Event Loss, where a positive number is the amount of loss and a negative number would be indicating a gain. This is a settable threshold for the Pass/Fail feature.

#### 2POINT

2 Point Loss from the end of the dead zone of the previous event to the beginning of current event.

#### DB/KM

dB per Kilometer if in KM unit of measure and DB/KF if in Kilo-Feet unit of measure. This is the calculated loss per Km or Kf from the end of the dead zone of the previous event to the beginning of the current event.

#### TYPE

Event Type is the type of event or the ORL measurement. If the event is a splice with no reflection, "splc" will be displayed and if the event contains a reflection, the ORL value will be displayed. This is a settable threshold for the Pass/Fail feature

#### E

End Of Fiber at the bottom of the table will display location for the suspected end of fiber in the KM column, N/A in the Splice Column and Link Loss in the 2 POINT column. Link Loss may be set as a Pass/Fail Threshold. The DB/KM or KF is the calculated dB loss per Km or Kf for the full link and the TYPE column will display the word Link.

To the right of the table is a scroll bar which will be active if the amount of events exceeds one page and below the scroll bar is an indication of what page is display per number of pages. Below the page number information are the parameter settings for the currently highlighted trace.

### 8.4 Sensitivity Settings

There are three levels of sensitivity while in the event table. The sensitivity is set via the Sense soft key. Use the Menu button to access the Soft Keys and use the Directional buttons to highlight the Sense key. Press the Select button to cycle through HI, for events with loss down to approximately 0.1dB, Medium (Md) with events down to approximately 0.2dB and Low (Lo) for event down to about 0.5dB. Highest sensitivity settings should be used for high signal level, low noise, long pulse, averaged traces.

### 8.5 Pass/Fail Settings

Splice, ORL and Link are all settable thresholds for Pass/Fail purposes. To set the thresholds, press the Menu button, use the directional buttons to highlight desired Soft Key, press the Select button and use the Directional buttons to reach the desired value. Press Select button again to lock in the settings. If the trace fails any of the three thresholds, a red X will be displayed in the P/F column and the suspect threshold value will be displayed in red.

Examples:

Splice: If a splice needs to be less than 1dB, set the threshold to <1.0.  
If 1.0 would be accepted, set threshold to 1.01db.

ORL: If an ORL needs to be less than -50dB, set the threshold to <50.  
If 50dB is acceptable, set the threshold to <49.

Link: If the link loss needs to be less than 20dB, set the threshold to <20.  
If 20db link loss is acceptable set the threshold to <21.

To return to trace view, press the Menu button, use the directional buttons to move to the Show Trace soft key and press the Select button.

## 9.0 File Management

### 9.1 Opening File Management

To open the File Management System press the Menu button and use the directional buttons to highlight the TRC (Disc). Press the Select button to enter the file management system. Traces will be labeled from 000 to 999. The file names are limited to 8 characters with a .### suffix. To close the File Management System, press the Menu button, use the directional buttons to highlight the Return soft key and press Select. To the right of the file table is a scroll bar which will be active if the amount of traces exceeds one page and below the scroll bar is an indication of what page is display per number of pages. Below the page indicator are the parameters for the highlighted trace file.

### 9.2 File Management Display

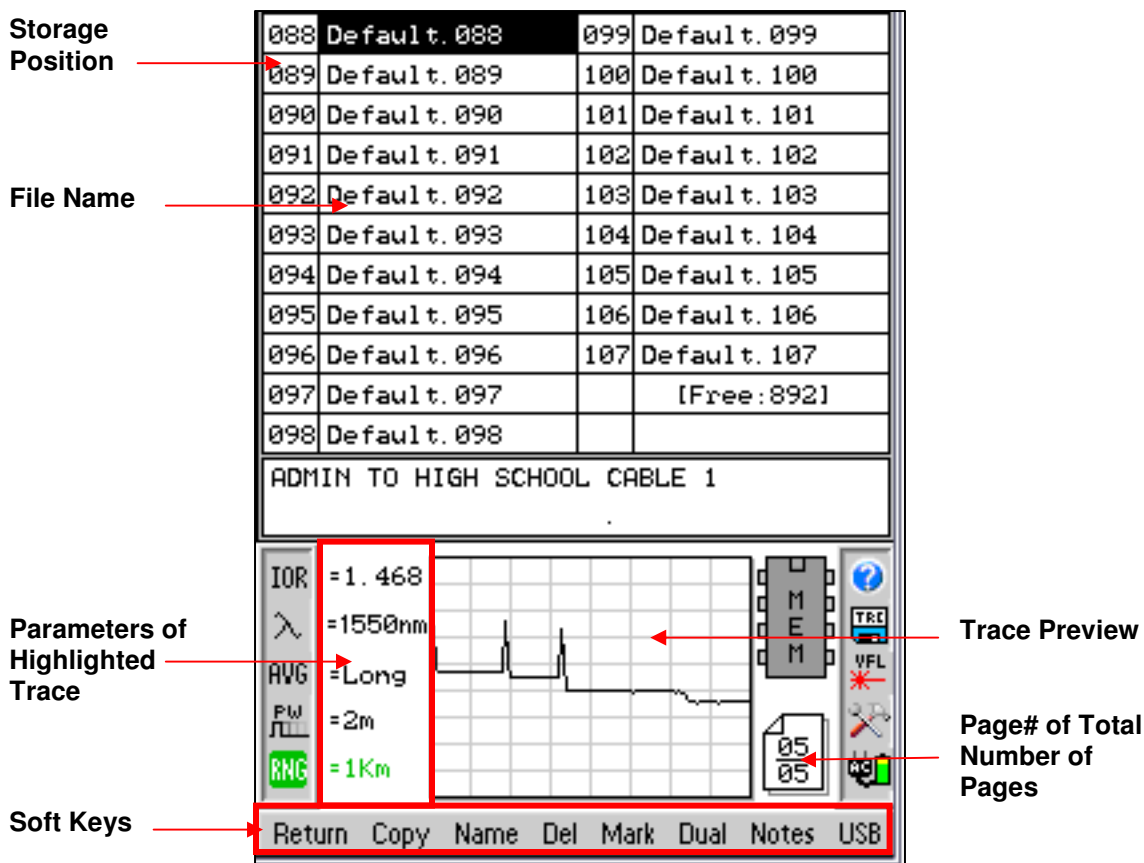

Fig 9.2



### 9.3 Saving a Trace

There are two methods to save traces. The first is the Quick Save method described in section 7.8. The second method is to enter file management. With a trace on the display, press the Menu button, use the directional buttons to move to the File Management icon and press Select. Use the Directional buttons to move to the desired file storage location. This must be an empty position. (The location with [Free:###] is an empty position.) Press the Select button and a new file will be started. There will be a highlighted character position followed by (.###, where ### is the storage position number) Use the Directional buttons to change the character and press Select when the desired character is displayed. The available Characters are 0 to 9, a to z, and A to Z. The "blank" is used to erase a character and moves the cursor back to the beginning of the filename. (The file name does not support "blank" characters). After each character is entered, the next highlighted position is populated with a lower case "a". Use the Scroll wheel to display the desired character and press Select to move to the next Character. When the last character of the file name is displayed, do not press the Select button. Press the Menu button and Save Changes soft key will be highlight, press Select or use the Directional buttons to highlight Discard Changes and press Select. In order to maintain continuity between the OTDR, flash drive and computer, keep the file name to 8 characters with a (.###) extension. The (.###) will be assigned by the OTDR file management system and represents the file number

### 9.4 Renaming a Trace

To rename a trace, highlighted the file to be renamed, press the Menu button and use the directional buttons to move to the Rename soft key. Press the Select button and the first character will be highlight in the file name. Refer to Saving a Trace above for file naming procedure. When desired changes are made, press the Menu button again and select Save Changes or Discard Changes.

### 9.5 Viewing Saved Trace

To view a saved trace from internal memory, use the directional buttons to highlight the desired trace and press the Select button. The OTDR will return to the trace view with the select trace displayed and directly below the trace will be the trace name and the date/time stamp.18

### 9.6 Dual Trace

**Note:** To compare two traces, they must have the same Range (RNG) settings.

With a trace displayed, either a trace just taken or one from file storage. Enter the file management mode, highlight the trace to be placed in the background, press the Menu button, use the directional buttons to move to the Dual soft key and press Select. The background trace will be displayed in green. All the measurement information displayed will be derived from the main trace. If the trace for the background does not have the same range as the main trace, a range mismatch message will be displayed. Press the Select button to clear the message.

To exit the Dual Trace mode, start a new scan or open a new main trace from the file management.

### 9.7 Marking Traces for Mass Coping and Deleting

When in the File Management System, use the directional buttons to highlight the first trace to be copied or deleted. Press the Menu button and use the directional buttons to move to the Mark soft key and press Select. To mark 1 or 2 files for mass copying, press the Select button and the highlighted trace will be displayed in red font and the next trace will be highlighted, pressing select again will mark the highlighted file and continue to the next file. The red font indicates that the trace is marked for mass management. To mark a large number of files the Directional buttons may be used. While in the Mark file mode, using the directional buttons to move down (forward: lower to higher number files) will mark a file or use the directional buttons to move up (backward: higher to lower numbered files) will un-mark a file. To skip files, shut off the feature by pressing the Menu button and move to the next file to be marked. Press the Menu button again and press Select to turn the feature back on. Now use the Directional buttons or Select button to continue marking files. Individual files may be un-marked by pressing Select on a marked file will un-mark it. Press the Menu button again to exit the marking mode and proceed to copy or delete the marked files.

## **9.8 Adding Default Notes.**

A Default note may be saved with a trace. To enter default notes for trace files, scroll to any empty or Free location, press the Menu button, scroll to the Notes soft key and press Select. The first Character of the note box is highlighted. Use the Scroll Wheel to select the desired character and press select. Continue on until the note is complete. To erase the characters and move forward, use the "blank". To quickly return to the beginning of a note, press the Menu button and then the Select button on the Notes soft key. To exit the Notes box, press the Menu button. This note will now be the default note for all traces until it is changed or removed. To remove notes, Press Select on the "blank" character until all characters have been removed.

## **9.9 Copying Traces**

Traces may be copied to a PC for use with the certification software. The Certification Software is required to copy trace files to a PC. The certification software will prompt this action when required ready to receive trace files. With a trace files highlighted or a group of traces marked, press the Menu button and use the directional buttons to move to the Copy soft key. Press Select and a Select

## **9.10 Deleting Traces**

Traces may be deleted from the internal memory or USB flash drive. With a trace highlighted or group of trace marked, press the Menu button and use the directional buttons to move to the Delete soft key. Press Select and Cancel or Confirm Delete will be displayed at the top of the screen. Use the Directional buttons to highlight the desired action and press select.

## 10.0 OTDR Application Information.

### Optical Time Domain Reflectometer Measurements.

The Bobcat OTDR is designed to be used as an installation, troubleshooting, and maintenance tool. The Bobcat OTDR is a full featured Optical Time Domain Reflectometer, but unlike OTDRs that cost thousands of dollars more, the Bobcat OTDR is very simple to operate. To understand more about OTDR operation, please review the FIS Fiber Optic Lab Manual section 10, OTDR Theory and Use, or consult with our knowledgeable technical support staff.

The Bobcat OTDR measures distance and loss of fiber links up to 240Km by launching an optical pulse down one end of the fiber and analyzing the returned energy in time (or distance) from reflections. The Bobcat OTDR uses an advanced high speed embedded controller and display processor with proprietary technology to analyze, store and average the fiber trace data in the quickest time. This high speed processing engine allows the user to make distance and loss measurements immediately after energizing the instrument. With its advanced Event Table, Splice Loss Mode and dB/Km Mode, it also can assist the user in interpreting major events such as bad splices, connections or broken ends. Minor perturbations along otherwise normal fiber links can also be detected using a simple moving cursor approach in Splice Loss Mode. Complex return signals with many major or minor events can be analyzed by the Bobcat OTDR then stored away for archiving and later retrieval.

As with any OTDR to assist in obtaining reliable, consistent measurements, the user must be aware of the Index of Refraction of their fiber or cable. The fiber Index of Refraction (IOR) is an important parameter that must be entered by the user to maximize the distance measurement accuracy. The IOR is proportional to the speed of light in glass compared to the speed in a vacuum and can be calculated by the equation  $IOR = C$  (the speed of light in a vacuum) /  $V$  (the speed of light in fiber). The IOR number can be obtained by the fiber or cable manufacturer or can be calculated with a known length of cable. IOR numbers generally fall around 1.468 SM, 1.486 MM. These are the default values in the OTDR, but can be adjusted from 1.0 to 2.0.

To calibrate the IOR for your particular fiber, take a known distance of fiber or cable (best if around 1 kilometer), and measure the distance with the Bobcat OTDR set for 2m pulse width, changing the IOR until the measured distances closely match. An error of .001 of the IOR entry (1.468 vs. 1.469) equates to an error of approximately 0.7 meters per kilometer of distance measured.

## 11.0 Loss Test Set Description

### 11.1 Entering Loss Test Set Mode

To enter the LTS mode, enter the Menu mode, open the Tools menu, highlight the LTS icon and press the Select button.

### 11.2 Key Pad Operation



Power button, turns the unit On and Off.



Resets any temporarily memory values before they have been stored with the select button.



Starts the Auto Test function. The light source will be turned on and cycle through the wavelengths selected with the  $\lambda$  Icon.



Toggles between the Test Mode and the Menu mode where the focus of the Directional buttons and the Select Button are on the soft keys and icons.



Cycles through the power meter wavelengths selected with the  $\lambda$  Icon. When in the File Selection Screen this key will toggle through save wavelength values for a particular storage position.



Changes the display to the zoom screen where all stored test for a memory location are display. There can be up to 4 test stored per location.



Fig 11.1



The Select Button will store all measurements in the temporary memory to the storage position shown the upper left corner while in the Test Mode and while in the Menu mode it will activate an icon item or soft key.

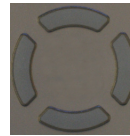

### Directional Buttons

When the Directional buttons is moved the File Selector screen is displayed for quick reference and if no key is press for 5 seconds, the display returns to the test mode. To return to test mode immediately, use the Scan button

When in Menu mode, the Directional buttons moves through the Soft Keys and Icons. For most situations, Left and Down are the same and Right and Up are the same.

## 11.3 LTS Displays

### LTS Measurement Screen

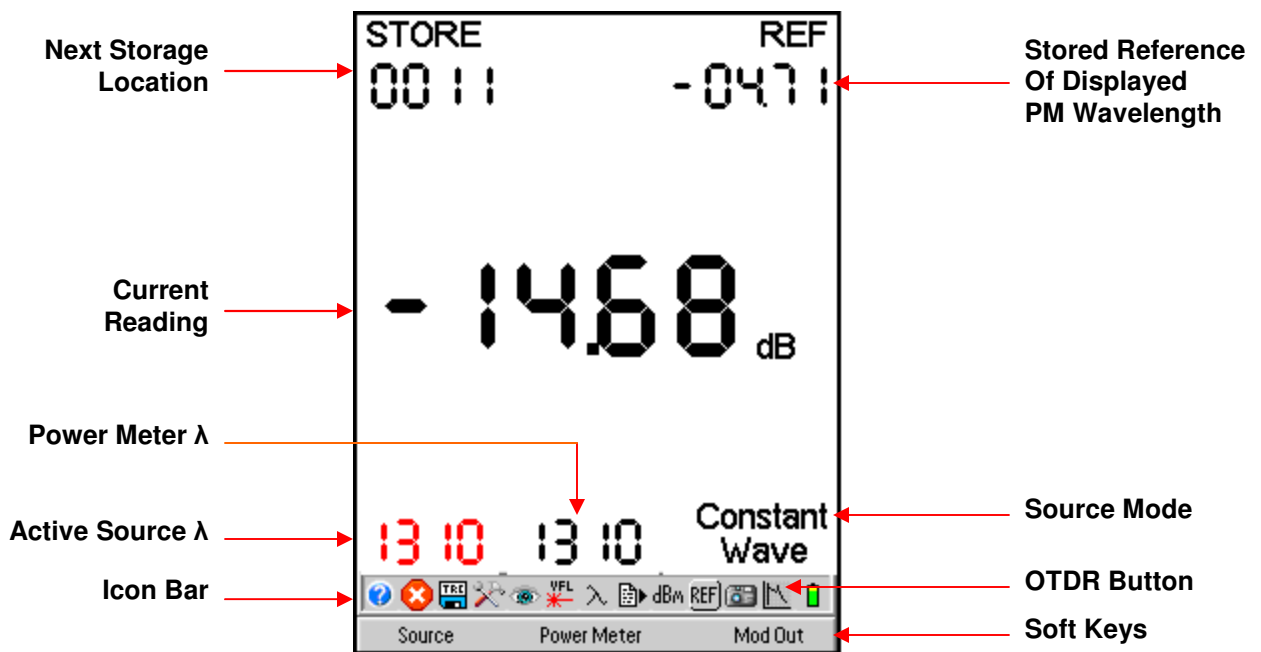

Fig 11.2

### LTS File Storage Access Screen

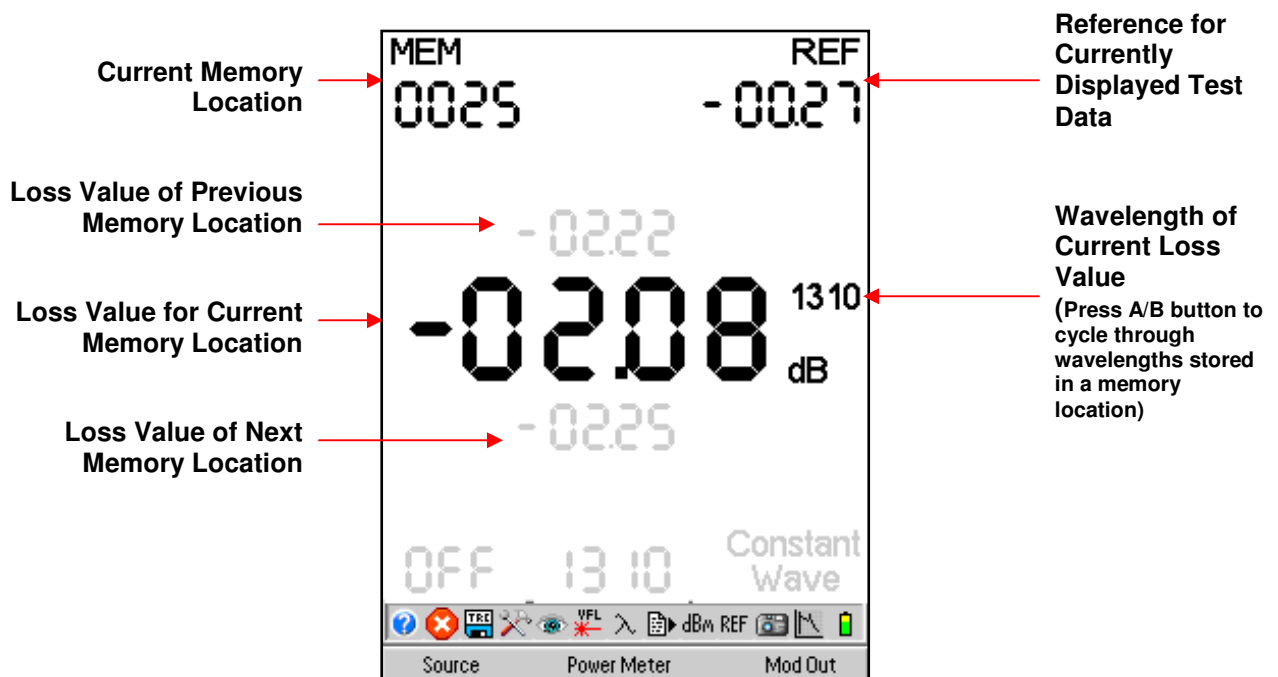

Fig 11.3

### 11.3 LTS Displays (continued)

#### LTS Zoom Screen

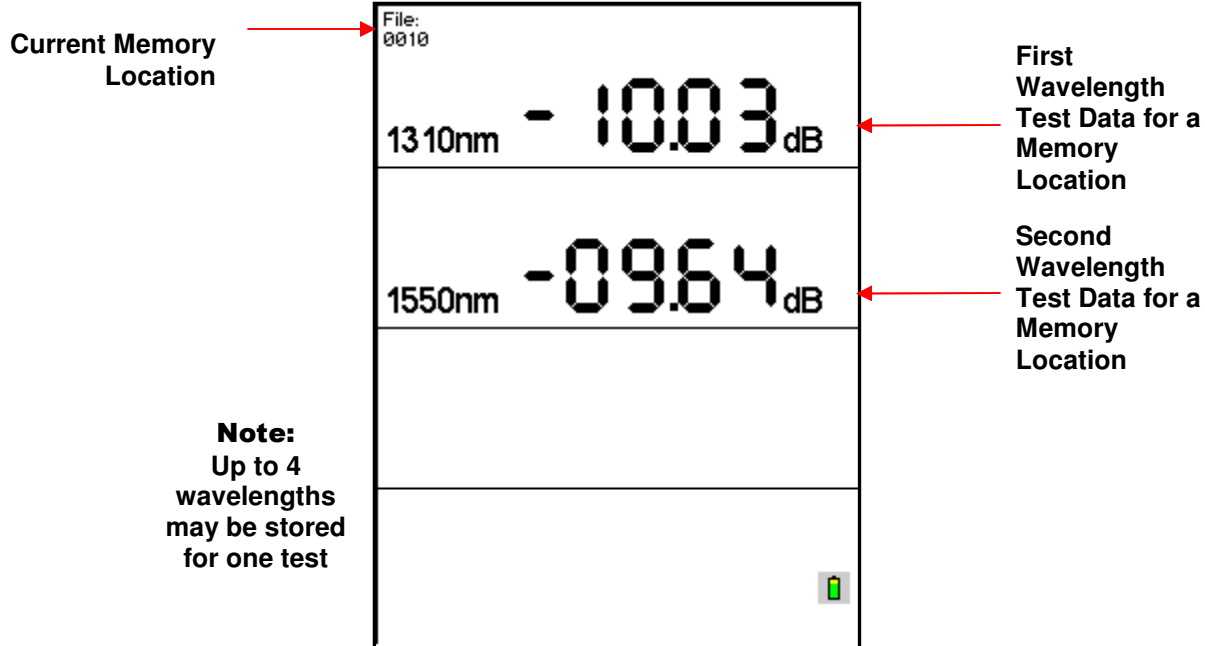

Fig 11.4

#### LTS Graph Screen

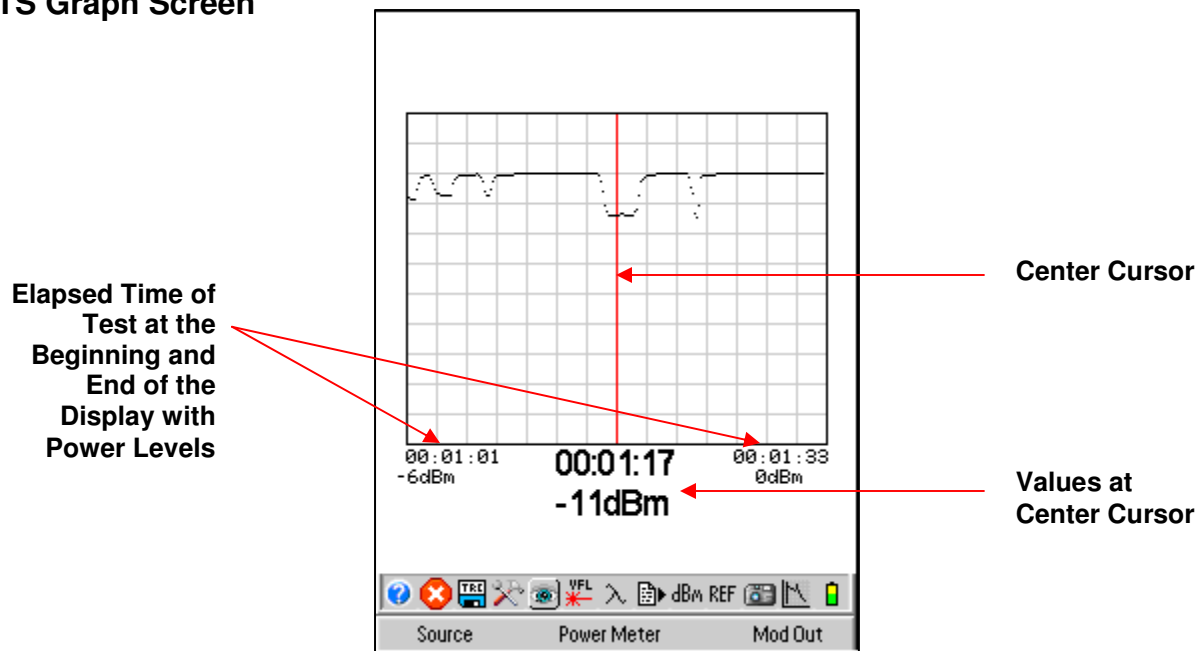

Fig 11.5

## 11.4 Soft Keys Operation

### Source

Enter the Menu mode and use the Directional buttons to highlight the Source soft key. Press the Select button to cycle through the available wavelengths. (See Lambda/wavelength icon information below) The displayed source wavelength is the active source. Turn off all sources, by cycling to the "Off" position.

### Power Meter

Enter the Menu mode and use the Directional buttons to highlight the Power Meter soft key. Press the Select button to cycle through the available wavelengths. (See Lambda/wavelength icon information below) The shown power meter wavelength is the one being tested.

### Modulation

There are four source modulation settings. 270 Hz, 1000Hz, 2000Hz and CW (constant wave). To change the modulation setting, enter Menu mode and use the directional buttons to highlight the Modulation soft key. Press the Select button to cycle through the modulation rates.

## 11.5 Loss Test Set Icon List

### Help

The Loss Test Set has an onboard help feature. To access the help feature, enter the Menu button, use the directional buttons to highlight the Question Mark Icon and press the Select button. Use the directional buttons to move to the desired topic and press the Select button. Press the Menu button again to exit the help feature.

### Delete

Deleting a stored loss measurement is accomplished in the File Selector mode. (see LTS File Selector operation, Section 12.4) To delete a measurement/s from a single memory location, use the directional buttons to display the location to be deleted. **Note:** the LTS File Selector will time out after approximately 5 seconds of no activity and return to the Loss Measurement mode. Enter the Menu mode, use the directional buttons to move to the Red Delete Icon and press the Select button. This will delete all the measurements of the displayed storage/memory location. **Note:** There is not warning or confirmation necessary to delete one memory location.

To delete the all the memory locations at one time, follow the procedure above, however do so on an empty location. Note: A loss measurement of (---) is not empty if there is a wavelength displayed to the right. That would be a null measurement). An empty location is (---) with no wavelength displayed to the right. When the Delete icon is select on the empty location, a Confirm dialog with "Delete all files?" will be displayed and the option to Delete or Cancel the action. Press the Select button with the desired action highlighted.

### Quick File Locator

To quickly move through the loss storage locations, enter the Menu mode, use the directional buttons to move to the TRC (disc) icon and press Select. The Memory location at the bottom of the display will be highlighted. Press the Select button to isolate the focus on the thousands position. Use the Directional buttons to make changes. Press the Select button again to move the focus to the hundreds position and repeat this procedure until the desired storage location is found. Using the directional buttons when all the digits are highlighted will move through the positions one at a time as normal. Press the Menu button again to exit the Quick File Locator.

### Tools Menu

To open the Tool Menu press the Menu button and use the directional buttons to highlight the Tools icon and press the Select button. All parts of the Tool Menu are accessible, though there are no operational setting for the LTS located in the Tools Menu.

### View Graph

Selecting the View (eye) icon will change to the Graph Mode. For More information on the graph mode, see section 12.6. To revert back to the normal power meter mode press Select a second time with the View Icon highlighted.

Visual Fault Locator (VFL) To activate the VFL, press the Menu button and use the directional buttons to highlight the VFL icon, press the Select button and it will cycle the VFL through CW, Modulated and off again. The VFL will not operate while light sources are active.

#### Lambda/Wavelength Selection

Highlighting and selecting the  $\lambda$  Icon will display the Wavelength Selection menu. Use the directional buttons to highlight the wavelengths to be select for use with the light source and power meter and press the Select button to toggle them off and on. The selected wavelengths will be the only wavelengths tested in the auto test mode and the only ones available when cycling through the light source and power meter soft keys. Highlight "Save Selection" at the bottom of the menu and press the Select button to save the setting and return to the Loss test Set mode.

#### File Download

File Download is used to send the save Loss Test to a PC. Once the OTDR is connected to a computer with the certification software running, enter the menu mode and highlight the File Download icon. When directed to do so, press the Select button to immediately start a download to the computer via the USB cable. Press the Menu button to return to the test mode.



## 12.0 Loss Test Set Operation

### 12.1 Power Meter Measurements

#### Power Measurements

With the BOBCAT in Loss Test Set Mode. Connect the fiber carrying the optical power to be measured to the Power Meter port utilizing the appropriate adaptor. Select the power meter wavelength that matches the wavelength of the light being measured. The power reading will now indicate the optical power in units of dBm. If the power level is greater than +5 or less than -77 dBm the display will indicate an out-of-range condition by a series of dashes across the main display. For higher power, ask a representative about a CATV version power meter.

To save the power measurement to the storage location indicated below the STORE label press the Select button. The memory location will auto increment to the next available memory location.

#### Relative Measurements

To make a relative power measurement you must first save the reference power level. To store a reference level, attach reference cord/s and energize the light source. Enter the Menu mode, use the directional buttons to highlight the Ref icon and press the Select button. The reference is now stored in non volatile memory and displayed at the bottom right of the display. The units of measure will change to dB. Subsequent readings will now be displayed in terms of dB relative to the stored reference value. A reference memory location is available for each selected wavelength. A reference reading is required to change to dB measurement from dBm measurements.

Remove the connector from the power meter port and place the fiber under test inline between the reference cord and the power meter port. The reading displayed will be the loss of the fiber under test relative to the reference. Ensure the unit is not in Menu mode and press the Select button to store the measurement.

Stored power measurements may be recalled by moving the Directional buttons and the File Selector Screen will be displayed. If no buttons are press for 5 seconds after entering the File Selector mode, the unit will revert to the test mode. The Scan button may also be pressed to re-enter test mode.

### 12.2 Loss Test Set AUTOTEST

To use the Auto Test feature, connect the fiber to be tested to a compatible test set. The unit being used as the power meter should be in loss test set mode. The unit being used as the source should be set to Autotest. If Two Quad OTDRs are being used, only the wavelengths to be tested should be selected as sources by entering the Wavelength/Lambda selection menu. Only the wavelengths that are energized will be displayed on the power meter end. Once the source and power meter have cycled through the wavelengths to be tested, press the Select button to store the measurements. .

**Note:** A reference measurement is not used in the Auto Test Mode. The Source is modulated and has power level of -3dBm (-6dBm@1625). This method of measurement does not take into account the launch condition, thus the manual method of testing should be used when highly accurate measurements are required such as when testing the loss of an individual connector. The Auto Test annunciator will be displayed during Auto Test loss measurements. Two or more loss measurements are best viewed in the Zoom mode where all the selected wavelengths will be display at one time on the display.

## 12.3 Loss Test Set Light Source Operation

### Energizing Light Source

The lasers are initially in the off state when the LTS is launched. Enter the Menu mode and use the Directional buttons to highlight the Source soft key. Pressing Select will energize the available wavelengths in sequence. If used with a compatible test set or a companion Viper, The light source will transmit the wavelength information automatically to the receiving unit which then changes the power meter wavelength setting to correspond to the wavelength of the light source.

For compatible light sources or test sets, please contact your FIS sales associate.

### Modulating Light Source

Change the modulation of the light source by entering Menu mode and use the directional buttons to highlight the Modulation soft key. Pressing the select button will toggle through available modulation rates of CW, 270Hz, 1000Hz, and 2000Hz. The rate will be displayed directly under the Modulation soft key. Note that when measuring average power of the lasers the output will drop by exactly 3.01 dB as the source is off precisely half of the time. The modulation function is useful for fiber identification and for general purpose optical component testing. The unit that receives one of the modulated frequencies will flash the appropriate frequency annunciator.

*(The 3.01dB drop is also true of the laser output when in the Auto Test mode however the unit receiving this signal automatically compensates for the loss in average power and this is transparent to the user.)*

## 12.4 LTS File Selector

### File Selector Screen

Enter the File Selector Screen with the use the directional buttons. In the File Selector screen the soft keys will be inactive and grayed out. The Store location in the top left of the screen will be changed to MEM location and there will be three loss values on the display. The middle one is the measurement stored in the indicated memory location with the wavelength of the reading to the right. Pressing the A/B button will cycle through the readings stored in that location if more than one wavelength was stored. The grayed out readings above and below the main reading, are the measurements of the previous and next memory locations. If there is not activity in 5 seconds, the screen will revert back to the Test Mode. The Scan button will also revert the unit to the test mode.

NOTE: Pressing the Select button will overwrite the displayed test with whatever is in the temporary memory location. Four dashes without a wavelength indicator next to them represents an empty memory location if a wavelength indicator is displayed next to the four dashes, there is a null test stored to that location for the displayed wavelength. This test could be under or over scale.

### Quick File Locator

To quickly move through the loss storage locations, enter the Menu mode, use the directional buttons to highlight the TRC (disc) icon and press Select. The Memory location at the top of the display will be highlighted. Press the Select button to focus the highlighted area on thousands position. Use the Directional buttons to make changes. Press the Select button again to move the focus to the hundreds position and repeat this procedure until the desired storage location is found. Using the directional buttons when all the digits are highlighted will move through the positions one at a time as normal. Press the Menu button again to exit the Quick File Locator.

## 12.5 LTS File Transfer

To transfer files from the Loss Test Set to the computer, start the Cert-Soft certification software. Connect the OTDR to the computer with the supplied USB cable, go to the tools tab of the software, and select Baud Rate and choose Auto Detect or desired baud rate. Return to Tools Tab and select Download LTS Files, enter a file name and press Save. The Software will prompt the user to start the loss test set memory download from the OTDR. To start the memory download, enter Menu mode, highlight the File Download Icon and press Select. The download progress will be indicated by the UPLOAD counter in the bottom left corner of the display.

**Note:** If there is a communication error occurs, ensure you turn off and restart the OTDR.

## 12.6 Loss Test Set Graph Mode

To view measurements in the Graph Mode, press the Menu button, use the directional buttons to highlight the Light Source soft key and use the Select button to cycle to the desired wavelength for the test. If a source other than one compatible for auto-wavelength recognition with the OTDR is being used, ensure proper the power meter wavelength is selected. Once the source is energized and the power meter is taking a measurement, enter the Menu mode, use the directional buttons to highlight the Eye Icon (view), press Select and the Scan button to start the graph. Pressing the Scan button again will stop the graph. The elapsed time of the scan is noted at the beginning middle and end of the graph with the absolute value at each of those points displayed. The graph may also be viewed on the certification software. Please refer to the software for information on how to display the graph view on the computer. To exit the Graph Mode, press the select button again with the Eye Icon (view) highlighted.

## 13.0 Maintenance

### 13.1 Battery Replacement

To replace the batteries, remove the OTDR from the protective boot by pulling the bottom of the boot down and back allowing the unit to be removed. The battery door is located on the back side of the unit. Replace the batteries only with AA NiMH batteries. Spare battery packs are available with a charging unit for extended battery operation. If you install NiMH batteries that are dead or less than 1 volt each, charge these batteries for one (1) hour before using the Bobcat OTDR. For maintenance, batteries require a monthly periodic recharge.

**WARNING:** To Prevent Fire or Shock Hazard: Do not install other battery types; Do not use the battery charger without the batteries installed; Do not expose the battery charger to rain or excessive moisture; Do not use the battery charger when there are signs of damage to the enclosure or cord; Ensure that you are using the correct charger for the local line voltage; Do not use any other battery charger than the one provided with this instrument. Any other condition will void the warranty.

**Note:** For maintenance, batteries require a monthly periodic recharge.

### 13.2 Clock Battery

In order to ensure proper Time and Date stamps on test data, it is necessary to energize the Bobcat OTDR for a minimum of 5 minutes per month. If this is not accomplished, it will be necessary to reset the time and date information in the Tools Menu.

### 13.3 Laser Out Port

**Do not under any circumstance** view or inspect the laser output fibers, connectors, or the fiber under test through collimating or focusing optics. A video inspection microscope should be used to examine all fiber ends. Contact your FIS sales representative for video microscope information.

**WARNING:** Never clean or look directly into the fiber optic connector or the end of fiber attached to the OTDR or VFL unit while they are energized, to do so will expose the user to laser radiation and could result in personal injury or instrument damage.

**WARNING:** Before connecting to a patch cord or fiber under test, be certain the fiber has no active optical sources or instruments connected to the other end. Skin or eye damage could result from other high power sources e.g. EDFAs, or instrument damage could occur voiding the warranty.

In order to maintain a low loss fiber connection, care should be taken to adequately clean the ferrule of any connector to be inserted in the Laser Out Port. In the event that the port needs to be cleaned, first step is to be certain the instrument is off. We suggest the use of isopropyl alcohol and foam swabs specifically designed for cleaning connectors accepting 2.5mm ferrules.

### 13.4 Recalibration and Verification

Periodic verification of the BOBCAT OTDR is recommended to ensure that your instrument remains within specification. Although not imperative, we recommend a recalibration and verification once a year to make certain the instrument is functioning properly and performing to its rated specifications. Consult the factory for service.

## 13.5 OTDR Adapter Replacement

The OTDR is supplied with three easily interchangeable adapters per port, ST/SC/FC. To change an adapter, remove the two screws that hold the adapter in place, pull the adapter straight up from ferrule. It is suggested that you clean the exposed ferrule with appropriate cleanser and lint free wipe anytime you replace the ferrule.

**NOTE:** When replacing the adapter with one that does not have a chained protective cap, use the small screw in place of the larger screw that retains the end of the chain to the adapter base.

## 14.0 Specifications

<b>Specifications</b>	
Wavelength	850, 1300, 1310, 1550 ±20nm
Dynamic Range	27/26dB MM, 32/30dB SM
Pulse Width	20 - 10,000 ns
Units of Measurement	km, kf, mi
Event Dead zone	2m
Attenuation Dead Zone	5m
Resolution	.25 - 64m
Distance Range	1-64km MM , 1-240km SM
Typical Real-time Refresh Rate	4 Hz
Group Index of Refraction (GIR)	1.000 - 2.000
Linearity	± .05 dB/dB
Memory Capacity	1000
Memory Type	Internal
Connector Styles	FC, ST, SC Interchangeable
<b>Visible Light Source</b>	
Emitter Type	Laser
Wavelength	650nm ±5nm
Laser Safety Class	Class IIFDA21 CFR1040.10 & 1040.11 IEC 825-1: 1993
Connector Type	2.5mm Universal
Output Power	<1mW Max.
<b>Power Meter Specifications</b>	
Detector Type	InGaAs
Connector Type	2.5mm Interchangeable
Dynamic Range	+5 to -77dB
Calibrated Wavelengths	850,1300,1310,1490,1550 and 1625nm
Units of Measurement	dBm, dB
Resolution	.01dB
Power Measurement Uncertainty	± 0.18 dB under reference conditions, ± 0.25 dB from 0 to -65 dBm, ± 0.35 dB from 0 to +5 dBm and from -65 to -77 dBm
Autotest Range	0 to -40dB
<b>Light Source Specifications</b>	
Fiber Type	Single mode, Multimode
Wavelengths	850, 1300, 1310, 1550, 1625 nm ±20nm
Output Power	0 dBm (-3dBm @ 1625nm)
Laser Safety Classification	Class I Safety Per FDA/CDRH and IEC-825-1 Regulation
Modulation Modes	CW, 270 Hz, 1000 Hz, 2000 Hz
<b>General Specifications</b>	
Battery Charger/Power Supply	Universal
Battery	4 hr
Universal Dimensions (without rubber boot )	7.62" L x 3.88" W x 1.56" H (194mm L x 99mm W x 40mm H)
Weight	1.6 lbs
Communications ports	USB
Storage Temperature	-20 to 60 C
Operating Temperature Range	-10 to 50 C
Accessories Provided	Universal Battery Charger w/US, UK, Continental Europe, and Australian Plugs, Interchangeable FC/ST and SC Adapters, Windows/Telcordia SR4731 Software, Rubber Boot

Specifications are subject to change without notice

## 15.0 Warranty / Repair / Trouble Shooting

### 15.1 Warranty Information

This product, including all mechanical, electrical, and optical parts and assemblies are unconditionally warranted to be free of defects in workmanship and material for a period of one (1) year from the date of delivery.

This warranty does not apply to expendable parts such as batteries, nor to any instrument or component which has been subjected to misuse, alteration, or fiber connector damage. It is the customer's responsibility to understand all the instructions and specifications prior to operating this instrument. This warranty does not extend to any loss or damage consequent to the failure of the warranted product.

### 15.2 Repair

If repair is required, simply call Fiber Instrument Sales @ 1-800-500-0347 for return instructions and a RMA number.

### 15.3 Trouble Shooting

Symptom	Possible Cause	Solution
LCD dark	Power not on	Press <b>ON/OFF</b> key
	Batteries require recharging	Recharge batteries
	Batteries are missing, in backwards or need replacement	Check polarity, replace batteries, or contact factory for servicing
LCD white	Power cycled too quickly	Turn off wait 5 seconds – turn on
Instrument locked Up	Unexpected Operational Mode	Turn off (hold ON/OFF button in for 1 second) wait 5 seconds – then depress On/Off again button to turn the unit on.
Initial Backscatter low	Defective cord or dirty connector	Replace or clean cord
	Fiber Output port requires cleaning	Clean and inspect port
	Angle polish mated with UPC polish	Examine connector ends
Extra or “ghost” reflections on backscatter	Fiber too long for short pulse	Switch to 10m pulse if >4Km
	Fiber over 16Km/53Kft	Switch to 100m pulse if >16Km
	Fiber over 64Km/200Kft	Switch to 1km Mode if >64Km
USB hookup to PC not functioning properly	USB baud rate not set properly or too quick for computer	Set port baud rate properly or decrease Baud rate in instrument and certification software
	PC drivers not set properly	Uninstall & reinstall certification software and drivers

## 16.0 Version Control

Through a program of continuous improvement the upgrade of the features and performance of this instrument are an on going process. The instrument firmware version is accessible at "turn-on". The version is displayed on the bottom right-hand corner of the display. The version changes and approximate release dates are as follows.

V1.0 - 07/2009 - Original release - requires version 4.1 software

V1.2 - 04/2010 - Updated for greater than 255 file transfer - requires version 4.5 software

V1.3 - 09/2010 - Added Construction Mode, Default Notes and Miles unit of measure - requires version 4.5.5 software

V1.3 - 02/2011 - Added Loss Test Set Option