

PORTABLE AIR CONDITIONER

OWNER'S MANUAL

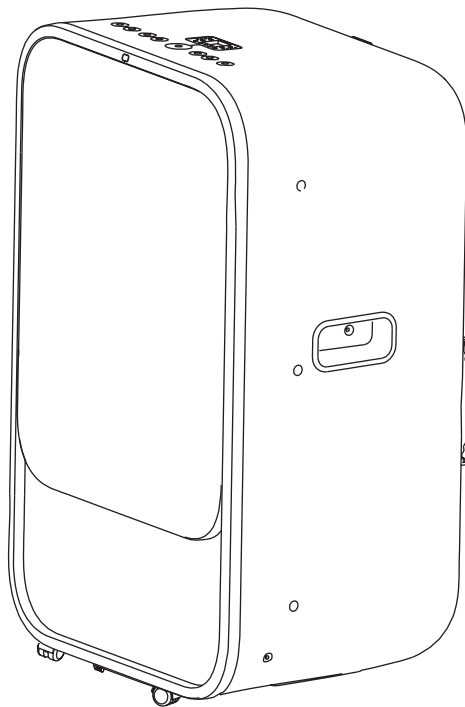

Inside you will find many helpful hints on how to use and maintain your air conditioner properly. Just a little preventative care on your part can save you a great deal of time and money over the life of your air conditioner. Before operating this product, please read the instructions carefully and save this manual for future use.

Read This Manual

Inside you will find many helpful hints on how to use and maintain your air conditioner properly. Just a little preventive care on your part can save you a great deal of time and money over the life of your air conditioner. You'll find many answers to common problems in the chart of troubleshooting tips. If you review our chart of Troubleshooting Tips first, you may not need to call for service at all.

CAUTION

- Contact the authorised service technician for repair or maintenance of this unit.
- Contact the installer for installation of this unit.
- The air conditioner is not intended for use by young children or infirm persons without supervision.
- Young children should be supervised to ensure that they do not play with the air conditioner.
- If the power cord is to be replaced, replacement work shall be performed by authorised personnel only.
- Installation work must be performed in accordance with the national wiring standards by authorised personnel only.

CONTENTS

SOCIABLE REMARK

Sociable remark.....	2
----------------------	---

SAFETY PRECAUTIONS

Safety rules	3
Operating condition	3
Electrical information	4

IDENTIFICATION OF PARTS

Accessories	4
Names of parts.....	5

AIR CONDITIONER FEATURES

Electronic control operating instructions	6
---	---

OPERATING INSTRUCTIONS

Operating instructions	7
------------------------------	---

INSTALLATION INSTRUCTIONS

Location	9
Window kit installation	9
Exhaust hose installation	12
Water drainage	13

CARE AND MAINTENANCE

Care and maintenance	14
----------------------------	----

TROUBLESHOOTING TIPS

Trouble shooting	15
------------------------	----

NOTE

The rating data indicated on the energy label is based on the testing condition of installing the un-extended air exhaust duct without adaptor A & B (The duct and the adaptor A & B are listed in the accessories chart of the Instruction Manual).

When using this air conditioner in the European countries, the follow information must be followed:

DISPOSAL: Do not dispose this product as unsorted municipal waste. Collection of such waste separately for special treatment is necessary.

It is prohibited to dispose of this appliance in domestic household waste.

For disposal, there are several possibilities:

- A) The municipality has established collection systems, where electronic waste can be disposed of at least free of charge to the user.
- B) When buying a new product, the retailer will take back the old product at least free of charge.
- C) The manufacture will take back the old appliance for disposal at least free of charge to the user.
- D) As old products contain valuable resources, they can be sold to scrap metal dealers.

Wild disposal of waste in forests and landscapes endangers your health when hazardous substances leak into the ground-water and find their way into the food chain.

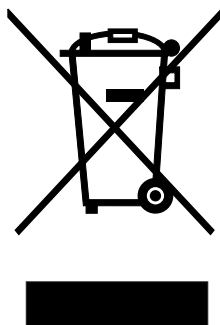

SAFETY PRECAUTIONS

Safety rules

To prevent injury to the user or other people and property damage, the following instructions must be followed. Incorrect operation due to ignoring of instructions may cause harm or damage.

! Always do this

- Your air conditioner should be used in such a way that it is protected from moisture. e.g. condensation, splashed water, etc. Do not place or store your air conditioner where it can fall or be pulled into water or any other liquid. Unplug immediately.
- Always transport your air conditioner in a vertical position and stand on a stable, level surface during use.
- Turn off the product when not in use.
- Always contact a qualified person to carry out repairs. If the supply cord is damaged it must be repaired by a qualified repairer.
- Keep an air path of at least 30cm all around the unit from walls, furniture and curtains.
- If the air conditioner is knocked over during use, turn off the unit and unplug from the mains supply immediately.

⊘ Never do this

- Do not operate your air conditioner in a wet room such as a bathroom or laundry room.
- Do not touch the unit with wet or damp hands or when barefoot.
- Do not press the buttons on the control panel with anything other than your fingers.
- Do not remove any fixed covers. Never use this appliance if it is not working properly, or if it has been dropped or damaged.
- Never use the plug to start and stop the unit.
- Always use the switch on the control panel.
- Do not cover or obstruct the inlet or outlet grilles.
- Do not use hazardous chemicals to clean or come into contact with the unit. Do not use the unit in the presence of inflammable substances or vapour such as alcohol, insecticides, petrol, etc.
- Do not allow children to operate the unit unsupervised.
- Do not use this product for functions other than those described in this instruction manual.

Energy Save

- Use the unit in the recommended room size.
- Locate the unit where furniture cannot obstruct the air flow.
- Keep blinds/curtains closed during the sunniest part of the day.
- Keep the filters clean.
- Keep doors and windows closed to keep cool air in and warm air out.

Operating condition

- The air conditioner must be operated within the temperature range indicated below:

MODE	ROOM TEMPERATURE
COOL	≥17°C /62°F
DRY	≥13°C/54°F
HEAT	≤30°C/86°F

Suggested tools for window kit installation

1. Screwdriver (medium size Phillips)
2. Tape measure or ruler
3. Knife or scissors
4. Saw (In the event that the window kit needs to be cut down in size because the window is too narrow for direct installation)

IDENTIFICATION OF PARTS







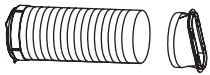

For your safety

- Do not store or use gasoline or other flammable vapors and liquids in the vicinity of this or any other appliance.
- Avoid fire hazard or electric shock. Do not use an extension cord or an adaptor plug. Do not remove any prong from the power cord.

▲ WARNING Electrical Information

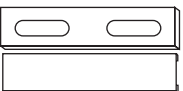
- Be sure the electrical service is adequate for the model you have chosen. This information can be found on the serial plate, which is located on the side of the cabinet and behind the grille.
- Be sure the air conditioner is properly grounded. To minimize shock and fire hazards, proper grounding is important. The power cord is equipped with a three-prong grounding plug for protection against shock hazards.
- Your air conditioner must be used in a properly grounded wall receptacle. If the wall receptacle you intend to use is not adequately grounded or protected by a time delay fuse or circuit breaker, have a qualified electrician install the proper receptacle.
- Ensure the receptacle is accessible after the unit installation.

Accessories

PARTS :	PARTS NAME :	QUANTITY :
	Exhaust hose and Adaptor B(flat mouth)	1 set
	Adaptor B(round mouth) (※)	1 set
	Wall Exhaust Adaptor A(※)	1 pc
	Expansion Plug and wooden screw(※)	4/ pc
	Window Slider Kit	1 set
	Foam seal	3/pc
	Remote Controller (For remote control models only)	1pc
	Battery(For remote controller)	2/pc

NOTE: Optional parts(※), some models without. The external appearance of the remote controller is for explanation purpose, the actual shape shall be depended on the model you purchased.

- Check all the accessories are included in the package and please refer to the installation instructions for their usage.

IDENTIFICATION OF PARTS

NAMES OF PARTS

Front

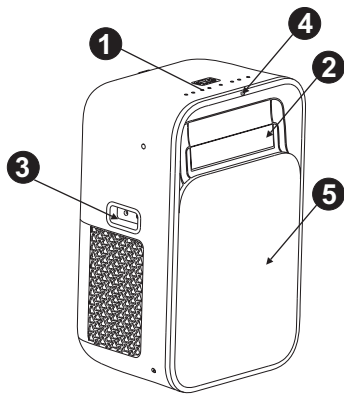

Fig.1

- ① Operation Panel
- ② Horizontal Louver Blade (swing automatically)
- ③ Carrying Handle (both side)
- ④ Remote signal receptor
- ⑤ Auto sliding panel

Rear

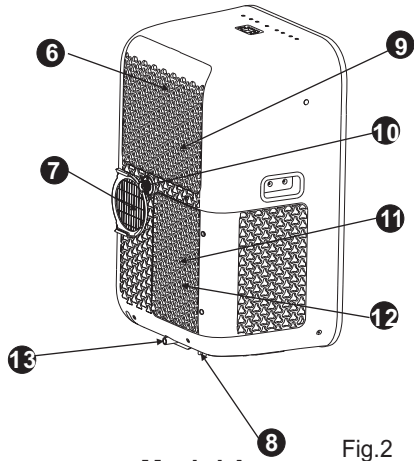

Fig.2

Model A

- ⑥ Upper Air Filter (Behind the grille)
- ⑦ Air Outlet
- ⑧ Wheel
- ⑨ Air intake
- ⑩ Drain Outlet
- ⑪ Air intake
- ⑫ Lower Air Filter (Behind the grille)
- ⑬ Bottom tray drain outlet
- ⑭ Exhaust hose

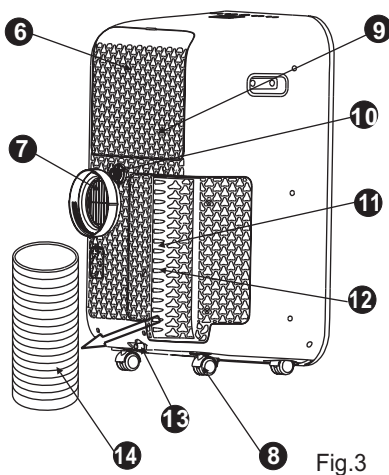

Fig.3

Model B

ELECTRONIC CONTROL OPERATING INSTRUCTIONS

Before you begin, thoroughly familiarize yourself with the control panel and remote controller and all its functions, then follow the symbol for the functions you desire.

The unit can be controlled by the unit control panel alone or with the remote controller .

NOTE: This manual does not include Remote Controller Operations, see the <<Remote Controller Instruction>> packed with the unit for details.

OPERATION PANEL OF THE AIR CONDITIONER

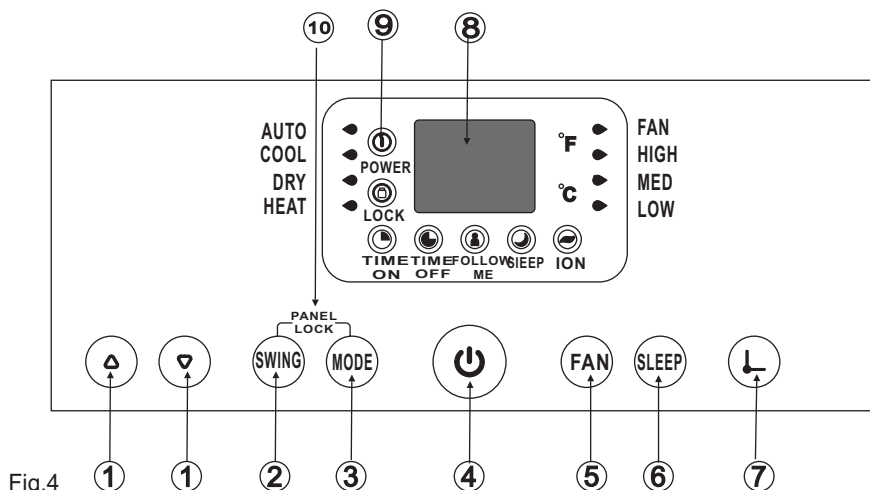

Fig.4

① UP(△) and DOWN(▽) button

Used to adjust (increasing/decreasing) temperature settings(1°C/1°F increments) in a range of 17°C(62°F) to 30°C(86°F) or the TIMER setting in a range of 0~24hrs.

NOTE: The control is capable of displaying temperature in degrees Fahrenheit or degrees Celsius. To convert from one to the other, press and hold the Up and Down buttons at the same time, for 3 seconds.

② SWING button

Use this button to initiate the auto swing feature or lock the louver at the desired position .

③ MODE select button

Selects the appropriate operating mode. Each time you press the button, a mode is selected in a sequence that goes from AUTO, COOL, DRY, HEAT(cooling only models without) and FAN.The mode indicator light illuminates under the different mode setting.

④ POWER button

Power switch on/off.

⑤ FAN button

Press to select the fan speed in four steps-LOW, MED(on some models), HIGH and AUTO. The fan speed indicator light illuminates under different fan settings except AUTO speed. When select AUTO fan speed, all the fan indicator lights turn dark.

⑥ SLEEP button

Used to initiate the SLEEP operation.

⑦ TIMER button

Used to initiate the AUTO ON start time and AUTO OFF stop time program, in conjunction with the △ & ▽ buttons.

⑧ LED Display

-Shows the set temperature in " °C" or " °F" and the Auto-timer settings. While on DRY and FAN modes, it shows the room temperature.

OPERATING INSTRUCTIONS

Error codes:

- E1-** Room temperature sensor error-
Unplug the unit and plug it back in.
If error repeats, call for service.
- E2-** Evaporator temperature sensor error-
Unplug the unit and plug it back in.
If error repeats, call for service.
- E4-** Display panel communication error-
Unplug the unit and plug it back in.
If error repeats, call for service.
- E5-** The auto sliding panel malfunction-
Unplug the unit and plug it back in.
If error repeats, call for service.
- P1-** Bottom tray is full - Connect the
drain hose and drain the collected
water away. If error repeats, call
for service.
- E0-** Unit malfunction-- Unplug the unit and plug
it back in. If error repeats, call for service.

9 INDICATOR LIGHTS display

- ① - lights up when the POWER is on.
- ② - lights up when LOCK function is set.
- ③ - lights up when TIMER ON function is set.
- ④ - lights up when TIMER OFF function is set.
- ⑤ - lights up when FOLLOW ME function is set.
- ⑥ - lights up when SLEEP function is set.
- ⑦ - lights up when FRESH function is set by
remote controller.

10 LOCK function

Press and hold the SWING and MODE buttons simultaneously for 3 seconds, the auto sliding panel will be locked .
Press and hold the two buttons simultaneously for 3 seconds to cancel the lock function.

Operating Instructions

COOL operation

- Press the "MODE" button until the "COOL" indicator light comes on.
- Press the ADJUST buttons "▲" or "▼" to select your desired room temperature. The temperature can be set within a range of 17°C-30°C/62°F-86°F.
- Press the "FAN SPEED" button to choose the fan speed.

HEAT operation(cooling only models without)

- Press the "MODE" button until the "HEAT" indicator light comes on.
- Press the ADJUST buttons "▲" or "▼" to select your desired room temperature. The temperature can be set within a range of 17°C-30°C/62°F-86°F.
- Press the "FAN SPEED" button to choose the fan speed. For some models, the fan speed can not be adjusted under HEAT mode.

DRY operation

- Press the "MODE" button until the "DRY" indicator light comes on.
- Under this mode, you cannot select a fan speed or adjust the temperature.
- Keep windows and doors closed for the best dehumidifying effect.
- Do not put the duct to window.

AUTO operation

- When you set the air conditioner in AUTO mode, it will automatically select cooling, heating(cooling only models without), or fan only operation depending on what temperature you have selected and the room temperature.
- The air conditioner will control room temperature automatically round the temperature point set by you.
- Under AUTO mode, you can not select the fan speed.

FAN operation

- Press the "MODE" button until the "FAN " indicator light comes on.
- Press the "FAN SPEED" button to choose the fan speed. The temperature cannot be adjusted.
- Do not put the duct to window.

TIMER operation

- When the unit is on, first press the Timer button, the TIMER OFF indicator light illuminates. It indicates the Auto Stop program is initiated.
- When the unit is off, first press the Timer button, the TIMER ON indicator light illuminates. It indicates the Auto Start program is initiated.
- Press or hold the UP or DOWN button to change the Auto time by 0.5 hour increments, up to 10 hours, then at 1 hour increments up to 24 hours. The control will count down the time remaining until start.
- The selected time will register in 5 seconds and the system will automatically revert back to display the previous temperature setting.
- Turning the unit ON or OFF at any time or adjusting the timer setting to 0.0 will cancel the Auto Start/ Stop timed program.
- When the malfunction (E1 or E2) occurs, the Auto Start/Stop timed program will also be cancelled.

OPERATING INSTRUCTIONS

FOLLOW ME operation(on some models)

This feature can be activated from the remote control ONLY. The remote control serves as a remote thermostat allowing for the precise temperature control at its location.

To activate the Follow Me feature, point the remote control towards the unit and press the Follow Me button. The light on the unit control panel will illuminate to indicate it received the signal. It will continue to send this signal until the feature is deactivated by pressing the Follow Me button again. If the unit does not receive the Follow Me signal during any 7 minutes interval, the unit will beep to indicate the Follow Me mode has ended. The display on the remote control indicates the temperature at the remote ONLY. The actual temperature can be displayed at the unit by pressing the Fan Only mode. When in the Cool mode, the unit display indicates the set temperature.

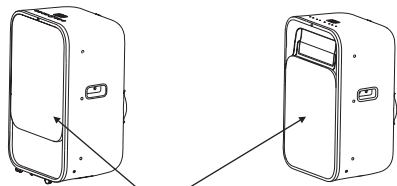

Auto sliding panel slide down automatically
Fig.5a

Danger !Do not put fingers here.

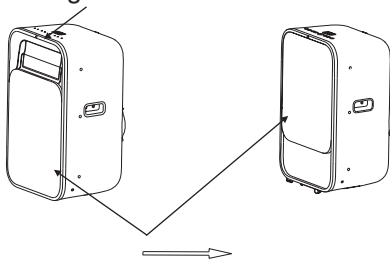

Auto sliding panel slide up automatically
Fig.5b

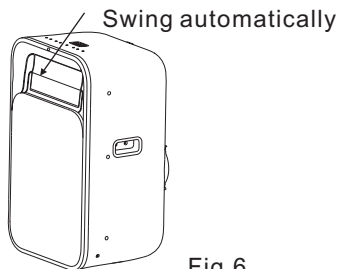

Swing automatically
Fig.6

ION operation(on some models)

This feature can be activated from the remote control ONLY.

To activate the ION operation, the anion generator is energized and will help to remove pollen and impurities from the air.

SLEEP operation

Press this button, the set temperature will increase (cooling) or decrease (heating) by 1°C/2°F in 30 minutes. The set temperature will then increase (cooling) or decrease (heating) by another 1°C/2°F after an additional 30 minutes. This new temperature will be maintained for 7 hours before it returns to the originally selected temperature. This ends the Sleep mode and the unit will continue to operate as originally programmed.

NOTE: This feature is unavailable under FAN or DRY mode.

LOCK operation

Press and hold the SWING and MODE buttons simultaneously for 3 seconds will lock the panel. It will not slide even the machine is turned off.

⚠ WARNING

NOTE: This machine is specially designed with an auto sliding panel. When the unit turns on, it will slide down automatically. And the air outlet is open (See Fig.5a). When the unit turns off, the panel slides up automatically and this may cause about 50-80N strength (See Fig.5b). Please pay attention do not put the fingers on the air outlet when the unit turns off and ensure children do not operate or play with the machine.

Other features

Power Outage

In the case of a power outage or interruption, the unit will automatically re-start, in the settings as used, after the power is restored.

Wait 3 minutes before resuming operation

After the unit has stopped, it can not be restarted operation in the first 3 minutes. This is to protect the unit. Operation will automatically start after 3 minutes.

Air flow direction adjustment

The louver can be adjusted automatically.

- **Adjust the air flow direction automatically (Fig.6):**
 - When the Power is ON, the louver opens fully. Press the SWING button on the panel or remote controller to initiate the Auto swing feature.
 - The louver will swing up and down automatically.
 - Please do not adjust the louver manually.

INSTALLATION INSTRUCTIONS

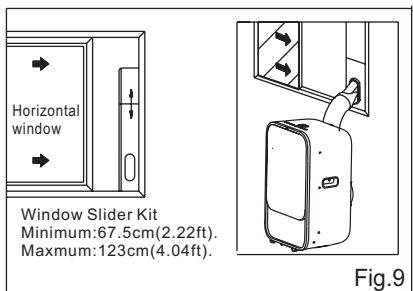
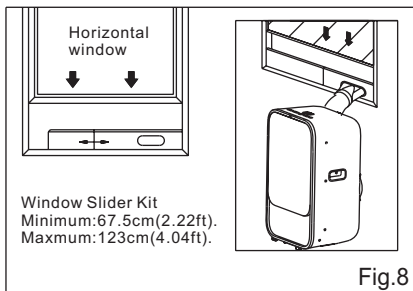
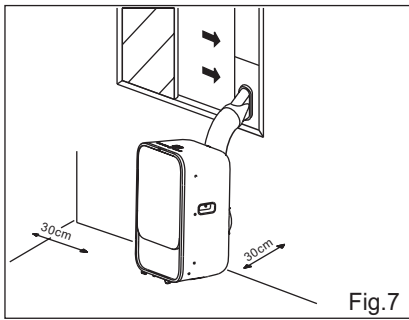

INSTALLATION INSTRUCTIONS

Location

- The air conditioner should be placed on a firm foundation to minimize noise and vibration. For safe and secure positioning, place the unit on a smooth, level floor strong enough to support the unit.
- The unit has casters to aid placement, but it should only be rolled on smooth, flat surfaces. Use caution when rolling on carpet surfaces. Do not attempt to roll the unit over objects.
- The unit must be placed within reach of a properly rated grounded socket.
- Never place any obstacles around the air inlet or outlet of the unit.
- Allow at least 30cm of space from the wall for efficient air-conditioning.

Window kit Installation

Your window kit has been designed to fit most standard "Vertical" and "horizontal" window applications, However, it may be necessary for you to improvise/modify some aspects of the installation procedures for certain types of window. Please refer to Fig. 8 & Fig.9 for minimum and maximum window openings.

Note: If the window opening is less than the mentioned minimum length of the window slider kit, cut that one with holes in it short to fit for the window opening. Do never cut out the hole in window slider kit.

Installation in a double-hung sash windows

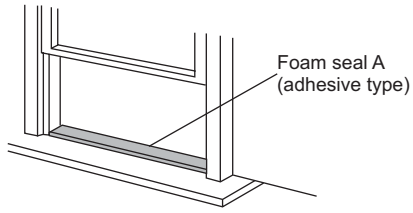

Fig.10

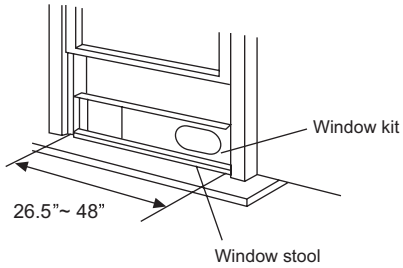

Fig.11

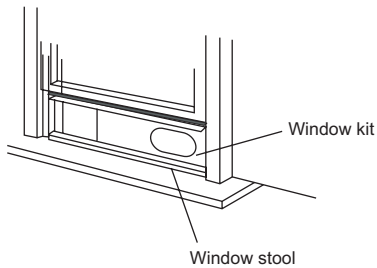

Fig.12

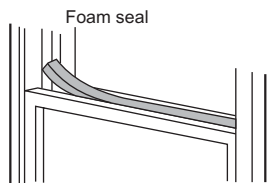

Fig.13

1. Cut the foam seal(adhesive type) to the proper length and attach it to the window stool. Fig.10
2. Attach the window slider kit to the window stool. Adjust the length of the window slider kit according to the width of window, short the adjustable window kit if the width of window is less than 27 inches.
Open the window sash and place the window slider kit on the window stool. Fig.11
3. Cut the foam seal(adhesive type) to the proper length and attach it on the top of the window. Show as in Fig.12
4. Close the window sash securely against the window.
5. Cut the foam seal to an appropriate length and sealing the open gap between the top window sash and outer window sash. Show as in Fig.13.

INSTALLATION INSTRUCTIONS

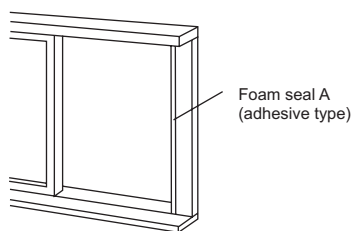

Fig.14

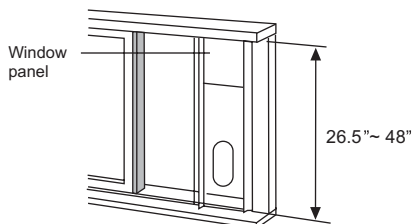

Fig.15

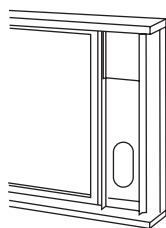

Fig.16

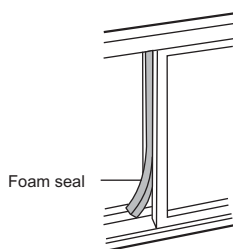

Fig.17

Installation in a sliding sash windows

1. Cut the foam seal(adhesive type) to the proper length and attach it to the window frame. See Fig.14.
2. Attach the window slider kit to the window stool. Adjust the length of the window slider kit according to the width of window, short the adjustable window kit if the width of window is less than 27 inches.
Open the window sash and place the window slider kit on the window stool. See Fig.15.
3. Cut the foam seal(adhesive type) to the proper length and attach it on the top of the window. Show as in Fig.16.
4. Close the sliding sash securely against the window.
5. Cut the foam seal to an appropriate length and sealing the open gap between the top window sash and outer window sash. Show as in Fig.17.

INSTALLATION INSTRUCTIONS

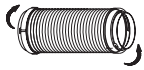

Fig.18

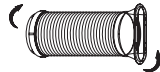

Fig.19

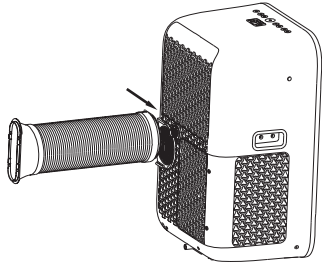

Fig.20

Exhaust hose installation:

The exhaust hose and adaptor must be installed or removed in accordance with the usage mode.

COOL mode	Install
FAN or DEHUMIDIFY mode	Remove

1. Install the window Exhaust adaptor B onto the exhaust hose as shown in Fig.18. or Fig.19. Refer to the previous pages for window kit installation.
2. Push the Exhaust hose into the air outlet opening along the arrow direction (See Fig.20)

The exhaust hose can be installed into the wall

(Not applicable to the units without adaptor A, expansion plugs and wooden screws of Accessories).

1. Prepare a hole in the wall. Install the wall Exhaust adaptor A onto the wall (outside) by using 4 expansion plugs and wooden screws, be sure to fix thoroughly. (See Fig.21)
2. Attach the Exhaust hose to wall Exhaust adaptor A.

Note:

Cover the hole using the adaptor cap when not in use.

- The duct can be compressed or extended moderately according to the installation requirement, but it is desirable to keep the duct length to a minimum.

IMPORTANT:

DO NOT OVER BEND THE DUCT (SEE Fig.22)

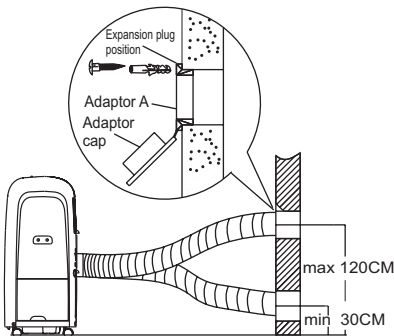

Fig.21

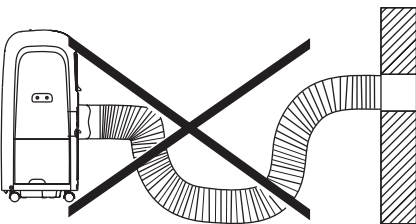

Fig.22

INSTALLATION INSTRUCTIONS

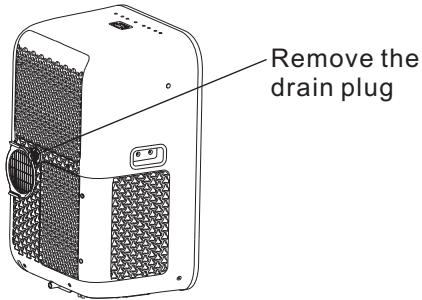

Fig.23

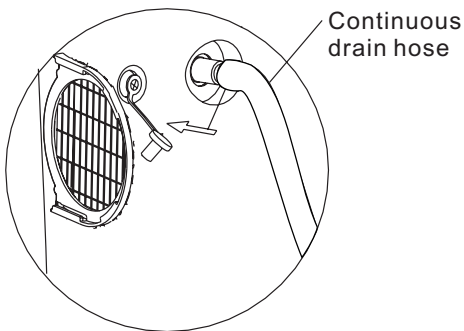

Fig.24

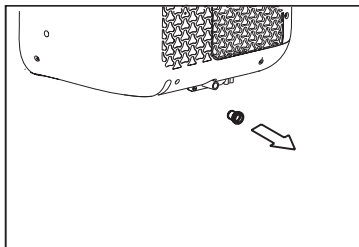

Fig.25

Water drainage:

- During dehumidifying modes, remove the drain plug from the back of the unit, install the drain connector(5/8" universal female mender) with 3/4" hose(locally purchased). For the models without drain connector, just attach the drain hose to the hole. Place the open end of the hose directly over the drain area in your basement floor. Please refer to Fig.23 & 24.
- When the water level of the bottom tray reaches a predetermined level, the unit beeps 8 times, the digital display area shows "P1". At this time the air conditioning/dehumidification process will immediately stop. However, the fan motor will continue to operate(this is normal). Carefully move the unit to a drain location, remove the bottom drain plug and let the water drain away(Fig.25). Restart the machine until the "P1" symbol disappears. If the error repeats, call for service.

CARE AND MAINTENANCE

IMPORTANT:

- 1) Be sure to unplug the unit before cleaning or servicing.
- 2) Do not use gasoline, thinner or other chemicals to clean the unit.
- 3) Do not wash the unit directly under a tap or using a hose. It may cause electrical danger.
- 4) If the power cord is damaged, it should be repaired by manufacture or its agency.

1. Air filter

- Clean the air filter at least once every two weeks to prevent inferior fan operation because of dust.

- Removal

This unit has two filter. Take the upper filter out along the arrow direction(Fig.26),then take the filter down.

Remove the lower filter by loosening the screw, taking down the air filter as shown in Fig.27 and Fig.28.

- Cleaning

Wash the air filter by immersing it gently in warm water (about 40°C/104°F) with a neutral detergent. Rinse the filter and dry it in a shady place.

- Mounting

Install the upper air filter after cleaning and install the lower filter by using the screw.

NOTE: The grill and the air filter are connected and can not be separated..

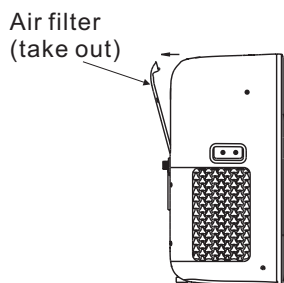
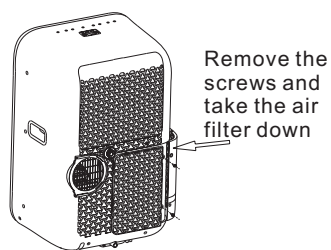
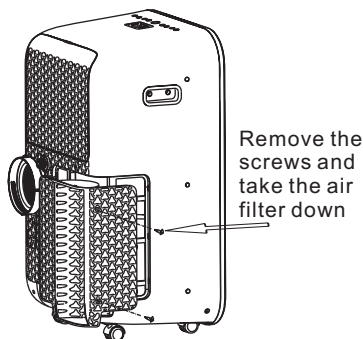

Fig.26



Model A

Fig.27



Model B

Fig.28

2. Unit enclosure

- Use a lint-free cloth soaked with neutral detergent to clean the unit enclosure. Finished by a dry clean cloth.

3. Unit idle for a long time

- Remove the rubber plug at the back of the unit and attach a hose to drain outlet. Place the open end of the hose directly over the drain area in your basement floor (See Fig.23 & 24).
- Remove the plug from the bottom drain outlet, all the water in the bottom tray would drain out (See Fig.25).
- Keep the appliance running on FAN mode for half a day in a warm room to dry the appliance inside and prevent mold forming.
- Stop the appliance and unplug it, wrapped the cord and bundle it with the tape. Remove the batteries from the remote controller.
- Clean the air filter and reinstall it.
- Disconnect the exhaust hose, keep it safety, and cover the window(wall) hole with the adaptor cap.

TROUBLESHOOTING TIPS

TROUBLE SHOOTING

TROUBLES	POSSIBLE CAUSES	SUGGEST REMEDIES
1. Unit does not Start when Pressing on/off Button	- P1 appears in the display window	Drain the water in the bottom tray.
	- Room temperature is lower than the set temperature.(Cooling mode)	Reset the temperature.
2. Not cool enough	- The windows or doors in the room are not closed.	Make sure all the windows and doors are closed.
	- There are heat sources inside the room.	Remove the heat sources if possible.
	- Exhaust air duct is not connected or blocked.	Connect the duct and make sure it can function properly.
	- Temperature setting is too high.	Decrease the set temperature.
	- Air filter is blocked by dust.	Clean the air filter.
4. Noisy or vibration	- The ground is not level or not flat enough.	Place the unit on a flat, level ground if possible.
5. Gurgling sound	- The sound comes from the flowing of the refrigerant inside the air-conditioner.	It is normal.
6. Power shut off at Heating mode	- The automatic over heat protection function. When the temperature at the air outlet exceed 70°C/158°F, the device will stop.	Switch on again after the unit has cool down.

CS558-U
202000192145
20091223