

# **Alpha<sup>®</sup> Variable Speed Wet Polisher Instruction Manual**

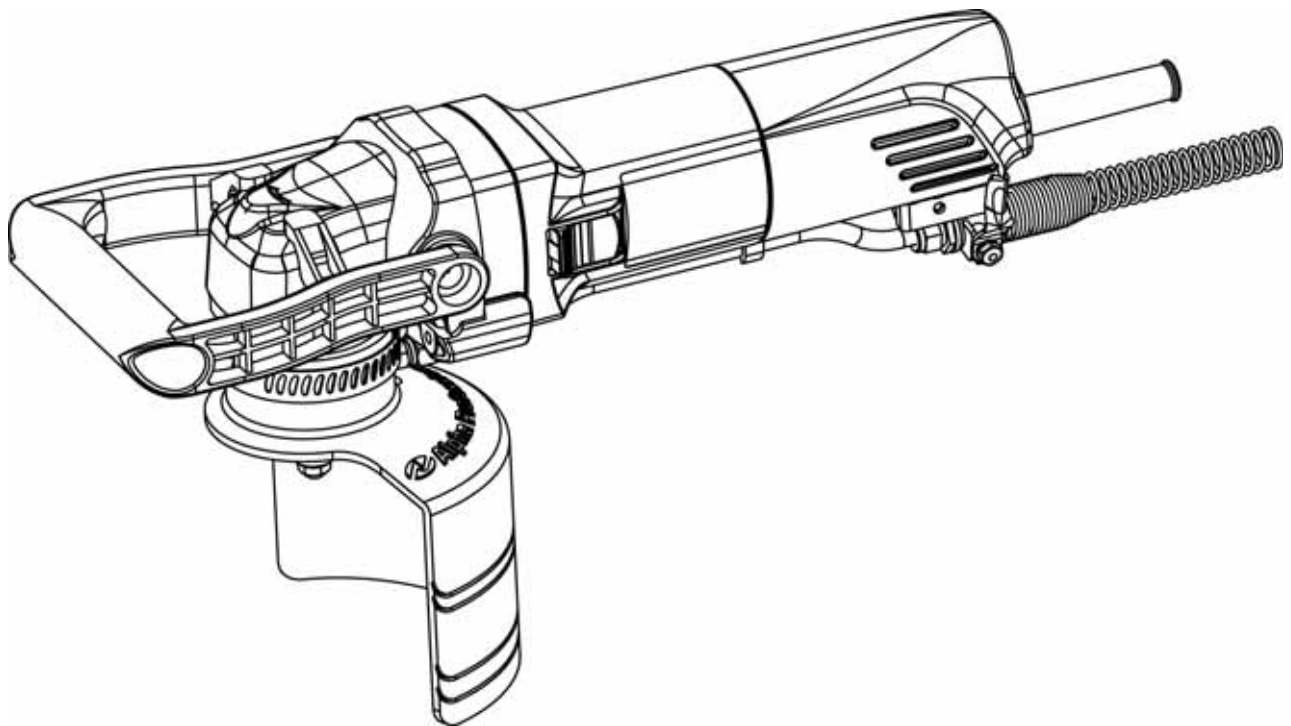

**Model No.: VSP-230**

**WARNING:** To reduce the risk of injury, user must read and understand instruction manual!

---

 **Alpha Professional Tools<sup>®</sup>**

103 Bauer Drive, Oakland, NJ 07436 • 800-648-7229 • Fax: 800-286-0114  
[www.alpha-tools.com](http://www.alpha-tools.com)

## **TABLE OF CONTENTS**

VSP-230 Overview .....	3
Specifications .....	3
Accessories .....	4
Introduction.....	5
About the Symbols .....	5
General Safety Rules .....	6
Work Area.....	6
Electrical Safety.....	6
Personal Safety .....	6
Tool Use and Care.....	7
Service .....	7
Specific Safety Rules.....	8
Use Proper Extension Cords.....	9
Grounding Instructions .....	9
Additional Precautions for using the VSP-230.....	10
Laws and Regulations Of Noise Levels.....	11
VSP-230 Variable Speed Wet Polisher Operation.....	12
Main Connection .....	12
Switching On and Off.....	12
Ground Fault Circuit Interrupter (GFCI).....	13
Testing In-line GFCI Unit .....	14
Variable Speed Adjustment .....	14
Speed Pot Feedback Sensor .....	15
Water Control Valve.....	15
Side Handle Installation.....	16
Customizing Splash Guard.....	17
Splash Guard Installation .....	18
Profiler and other approved Spindle Attachments .....	19
Water-Feed Attachment.....	19
Maintenance .....	20
Daily .....	20
Periodic .....	20
Bearings and gears .....	21
Carbon Brush Replacement .....	21
Rear Cover Removal .....	22
Alpha® VSP-230 Schematic .....	27
Alpha® VSP-230 Parts List .....	28
Services and Warranty Information .....	30
Loaner Program .....	30
Need More Information .....	30
Alpha® Tool Repair Service.....	31
Warranty .....	31
EC Declaration of Conformity .....	32
Appendix A.....	i

► **VSP-230 OVERVIEW**

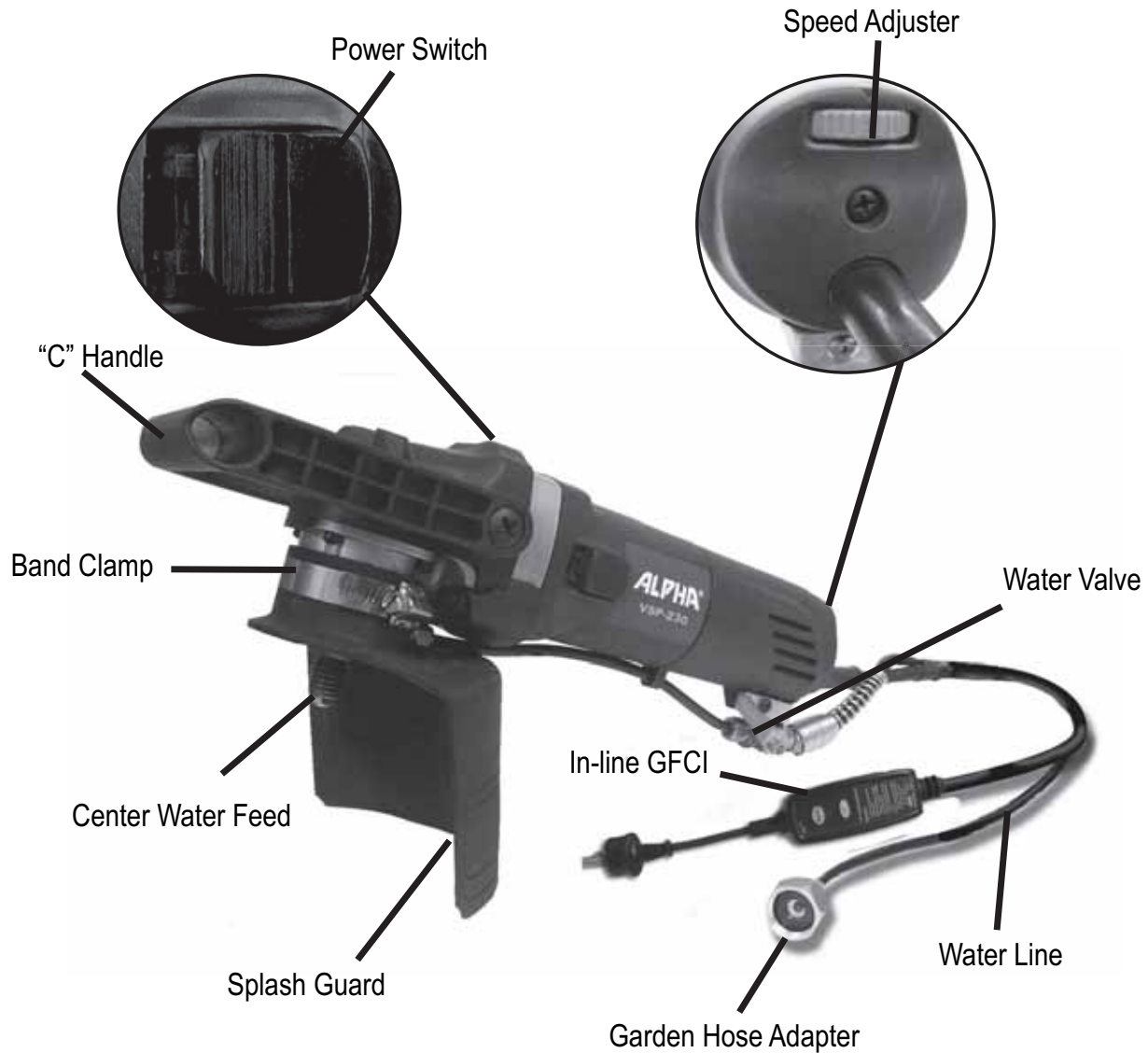

Figure-1

► **SPECIFICATIONS**

Working Power Supply .....	Single-phase AC, 50/60 Hz
Voltage .....	230V
Plug Type .....	C (230V)
Amperage.....	3.5A
Wattage .....	800W
Motor .....	Single-phase
No Load.....	500~2800 RPM
Polishing Disc Size.....	100mm
Cord.....	3m single-phase cable
Weight .....	3.3 kg
	[ Machine/Cord/GFCI/Water-Line/ Splash Guard

► **ACCESSORIES**



Figure-2

**COMPONENTS:**

1. Side Handle (Part No. 210074)
2. Wrench (Part No. 210073)
3. Band Clamp (Part No. 210088)
4. Splash Guard (Part No. 210089)
5. Spare Set of Carbon Brushes (Part No. 210083)

# INTRODUCTION

Thank you for purchasing the Alpha® Wet Polisher. Please read this instruction manual thoroughly to ensure safety and correct use of the polisher. Keep this manual in a place where operators can access it easily whenever necessary.

## ► ABOUT THE SYMBOLS

According to the hazard level, all safety notes in this manual are classified into “**DANGER**”, “**WARNING**”, and “**CAUTION**”.

 **DANGER!** Death or serious personal injury is imminent when handling this polisher incorrectly.

 **WARNING!** There is a possibility of death or serious personal injury when handling this polisher incorrectly.

 **CAUTION!** There is a possibility of personal injury or property damage when handling this polisher incorrectly.

*NOTE: In some situations, failing to observe WARNING notes could result in death or serious personal injury. Be sure to read and observe the safety notes to ensure safety and correct use of the polisher.*

## ELECTRICAL SYMBOLS

The following show the symbols used for tool.

<b>V</b>	Volts
<b>A</b>	Amperes
<b>Hz</b>	Hertz
<b>~ or a.c.</b>	Alternating Current
<b>n0</b>	No load speed
<b>.../min</b>	Revolution or reciprocation per minute
<b>kg</b>	Kilograms
	Protective Earth

## CAUTION!

The following are important notes for products, operation, and maintenance applicable to this polisher.

### GENERAL SAFETY RULES

#### ► **WORK AREA**

- **Keep your work area clean and well lit.** Cluttered benches and dark areas invite accidents.
- **Do not operate power tools in explosive atmospheres, such as in the presence of flammable liquids, gases, or dust.** Power tools may create sparks which may ignite the dust or fumes.
- **Keep bystanders, children, and visitors away while operating a power tool.** Distractions can cause you to lose control.

#### ► **ELECTRICAL SAFETY**

- **Grounded tools must be plugged into an outlet properly installed and grounded in accordance with all codes and ordinances.** Never remove the grounding prong or modify the plug in any way. Do not use any adaptor plugs. Check with a qualified electrician if you are in doubt as to whether the outlet is properly grounded. If the tools should electrically malfunction or break down grounding provides a low resistance path to carry electricity away from the user.
- **Avoid body contact with grounded surfaces, such as pipes, radiators, ranges, and refrigerators.** There is an increased risk of electric shock if your body is grounded.
- **Don't expose power tools to rain or wet conditions.** Water entering a power tool will increase the risk of electric shock.
- **Do not abuse the cord.** Never use the cord to carry the tools or pull the plug from an outlet. Keep cord away from heat, oil, sharp edges, or moving parts. Replace damaged cords immediately. Damaged cords increase the risk of electric shock.
- **When operating a power tool outside, use an outdoor extension cord marked "W-A" or "W".** These cords are rated for outdoor use and reduce the risk of electric shock.

#### ► **PERSONAL SAFETY**

- **Stay alert, watch what you are doing and use common sense when operating a power tool.** Do not use tool while tired or under the influence of drugs, alcohol, or medication. A moment of inattention while operating power tools may result in serious personal injury.
- **Dress properly.** Do not wear loose clothing or jewelry. Contain long hair. Keep your hair, clothing, and gloves away from moving parts. Loose clothes, jewelry, or long hair can be caught in moving parts or drawn into air vents.
- **Avoid accidental starting.** Be sure switch is off before plugging in. Carrying tools with your finger on the switch or plugging in tools that have the switch on, invites accidents.

- **Remove adjusting keys or wrenches before turning the tool on.** A wrench or a key that is left attached to a rotating part of the tool may result in personal injury.
- **Do not overreach.** Keep proper footing and balance at all times. Proper footing and balance enables better control of the tool in unexpected situations. Do not use on a ladder or unstable support.
- **Use safety equipment.** Always wear eye protection. Dust mask, nonskid safety shoes, hard hat, or hearing protection must be used for appropriate conditions.

#### ► **TOOL USE AND CARE**

- **Use clamps or other practical way to secure and support the workpiece to a stable platform.** Holding the work by hand or against your body is unstable and may lead to loss of control.
- **Do not force tool,** use the correct tool for your application. The correct tool will do the job better and safer at the rate for which it is designed.
- **Do not use tool if switch does not turn it on or off.** Any tool that cannot be controlled with the switch is dangerous and must be repaired.
- **Disconnect the plug from power source before making any adjustments, changing accessories, or storing the tool.** Such preventive safety measures reduce the risk of starting the tool accidentally.
- **Store idle tools out of the reach of children and other untrained persons.** Tools are dangerous in the hands of untrained users.
- **Maintain tools with care.** Keep tools sharp and clean for better and safer performance. Follow instructions for lubricating and changing accessories. Inspect the electrical cord periodically and if damaged, have it repaired by authorized service facility. Inspect extension cords periodically and replace if damaged. Keep handles dry, clean and free from oil and grease.
- **Check for damaged parts.** Before using the tool each day, a guard or other part that is damaged should be carefully checked to determine that it will operate properly and perform its intended function. Check for alignment of moving parts, breakage of parts, mounting, and any other conditions that may affect its operation. A guard or other part that is damaged should be properly repaired or replaced by an authorized service center unless otherwise indicated elsewhere in this instruction manual. Have defective switches replaced by authorized service center. Do not use the tool if it cannot be turned on and off by the switch.
- **Use only accessories that are recommended by the manufacturer for your model.** Accessories that may be suitable for one tool, may become hazardous when used on another tool.

#### ► **SERVICE**

- **Tool service must be performed only by qualified repair personnel.** Service or maintenance performed by unqualified personnel could result in a risk of injury.
- **When servicing a tool, use only identical replacement parts.** Follow instructions in the Maintenance section of this manual. Use of unauthorized part or failure to follow Maintenance Instructions may create a risk of electric shock or injury.

## ► **SPECIFIC SAFETY RULES**

- **Accessories must be rated for at least the speed recommended on the tool warning label.** Wheels and other accessories running over rated speed can fly apart and cause injury.
- **Hold tool by insulated gripping surfaces when performing an operation where the cutting tool may contact hidden wiring or its own cord.** Contact with a “live” wire will make exposed metal parts of the tool “live” and shock the operator.
- **Know your power tool.** Read operator’s manual carefully. Learn its application and limitations, as well as the specific potential hazards related to this tool. Following this rule will reduce the risk of electric shock, fire, or serious injury.
- **Always wear safety glasses with side shields.** Everyday eye-glasses have only impact resistant lenses; they are NOT safety glasses.
- **Protect your lungs.** Wear a face or dust mask if the operation is dusty.
- **Protect your hearing.** Wear hearing protection during extended periods of operation.
- **Inspect tool cords periodically** and if damaged, have repaired at your nearest Factory Service Center or other Authorized Service Organization. Constantly stay aware of cord location.
- **Check damaged parts.** Before further use of the tool, a guard or other part that is damaged should be carefully checked to determine that it will operate properly and perform its intended function. Check for alignment of moving parts, binding of moving parts, breakage of parts, mounting, and any other conditions that may affect its operation. A guard or other part that is damaged should be properly repaired or replaced by an authorized service center.
- **Do not abuse cord.** Never carry the tool by the cord or yank it to disconnect it from the receptacle. Keep cord away from heat, oil, and sharp edges. Following this rule will reduce the risk of electric shock or fire.
- **Make sure your extension cord is in good condition.** When using an extension cord, be sure to use one heavy enough to carry the current your product will draw. An undersized cord will cause a drop in line voltage resulting in loss of power and overheating.
- **Inspect for and remove all foreign objects from workpiece before polishing.** Follow this rule will reduce the risk of serious personal injury.
- **Drugs, alcohol, medication, Do not operate tool while under the influence of drugs, alcohol, or any medication.** Follow this rule will reduce the risk of electric shock, fire, or serious personal injury.
- **Keep hands away from polishing area.** Follow this rule will reduce the risk of cuts, scrapes, or serious personal injury.
- **Ground Fault Circuit Interrupter (GFCI) protection should be provided on the circuit or outlet to be used for the tool.** Receptacles are available having built-in GFCI protection and may be used for this measure of safety.
- **Save these instruction.** Refer to them frequently and use them to instruct others who may use this tool. If you loan someone this tool, loan them these instructions.



► **USE PROPER EXTENSION CORDS**

Use only three-wire extension cords that have three-prong grounding-type plugs and three-pole receptacles that accept the tool's plug. Make sure your extension cord is in good condition. Replace or repair damaged or worn cord immediately. When using an extension cord, be sure to use one heavy enough to carry the current your product will draw. An undersized cord will cause a drop in line voltage resulting in loss of power and overheating. Below table shows the correct size to use depending on cord length and nameplate ampere rating. If in doubt, use the next heavier gauge. The smaller the gauge number, the heavier the cord.

Ampere Rating		Total length of cord in Metric (230V )		
		8m	15m	30m
More Than	Not More Than	Metric Wire Size		
0	6	1.0mm <sup>2</sup>	1.5mm <sup>2</sup>	1.5mm <sup>2</sup>
6	10	1.0mm <sup>2</sup>	1.5mm <sup>2</sup>	2.5mm <sup>2</sup>
10	12	1.5mm <sup>2</sup>	1.5mm <sup>2</sup>	2.5mm <sup>2</sup>

► **GROUNDING INSTRUCTIONS**

This tool should be grounded while in use to protect the operator from electric shock. The tool is equipped with a three-conductor cord and three-prong grounding type plug to fit the proper grounding type receptacle. The green (or green and yellow) conductor in the cord is the grounding wire. Never connect the green (or green and yellow) wire to a live terminal.

► **ADDITIONAL PRECAUTIONS FOR USING THE VSP-230**

In addition to the general safety notes described on the preceding pages, please read and observe the following precautionary notes before using the polisher.

 **DANGER!**

1. **Check the working voltage.**  
Be sure the voltage available at power outlet matches specified voltage on the nameplate. If the polisher is used with higher voltage than specified, the motor will burnout. Any attempts to do so may damage the polisher or cause an accident or injury.
2. **Inspect all polishing discs.**  
Never use cracked, chipped or damaged polishing discs.
3. **Hold the polisher tightly at start-up.**  
Failure to do so may cause an injury due to high impact at initial start up.
4. **Stop using the polisher immediately when noticing any malfunctions or any suspicious abnormal noises.**  
Turn the power switch OFF and contact your dealer or Alpha Professional Tools® for repair.
5. **Handle the polisher with care.**  
If you accidentally drop the polisher, do not use it until checking that it is not cracked, deformed, or damaged in any way.
6. **Do not pour water or any liquids onto or inside the polisher.**  
It may cause electric shocks.
7. **Do not hold the polisher in a vice.**
8. **Do not touch any rotating parts.**  
Never touch the polishing disc of the polisher during operation with your hands.
9. **Do not leave the disc while spinning on the bench, floor or surface of your workpiece.**  
It may cause an accident or injury.

 **WARNING!**

10. **Attach the backer pad and polishing disc correctly by following the procedure in this instruction manual.**  
Attaching the polishing discs incorrectly may cause an accident.

11. **Observe any suspicious abnormal noises when a polishing disc is attached for the first time and polisher is turned ON.**  
It may cause bodily injury if the polishing disc flies off.
12. **Do not touch the polishing disc while spinning.**  
The polishing disc spins very fast and you may hurt yourself.
13. **Be careful of your surroundings when working in high places.**  
When working in high places, make sure there are no people below. Do not trap the power supply cord on anything or drop the polisher or any materials, otherwise, It may cause an accident.

► **LAWS AND REGULATIONS OF NOISE LEVELS**

Please observe local laws and regulations regarding noise level in order to avoid disturbing surrounding areas. Install a soundproof wall if required to comply with the local laws and regulations.

# VSP-230 VARIABLE SPEED WET POLISHER OPERATION

## CAUTION!

Always be sure that the tool is switched off and unplugged before adjusting or checking function on tool.

### ► **MAIN CONNECTION**

Connect only to single-phase AC current supply and only to the main voltage specified on the rating plate.

### ► **SWITCHING ON AND OFF**

## CAUTION!

Before plugging in the tool, always check the working voltage be sure that the voltage specified is on the name plate. Before plugging in the tool, always check to see that the slide switch actuates properly and returns to the “OFF” position when the rear of the slide switch is depressed.

#### **Switching on:**

Switch can be locked in “ON” position for ease of operator comfort during extended use. Apply caution when locking tool in “ON” position and maintain firm grasp on tool. Push power switch to the forward position until it locks into position as shown in Figure 3.

#### **ON POSITION**

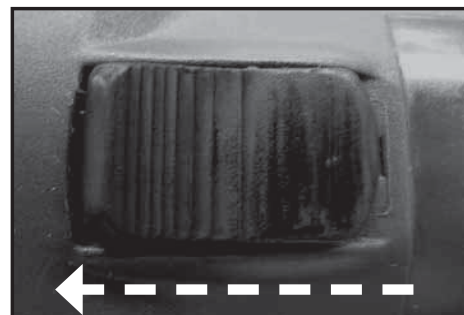

Figure-3

#### **Switching off:**

Push down on power switch to release to the rear position as shown in Figure 4.

#### **OFF POSITION**

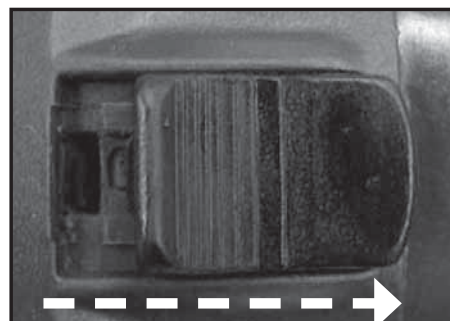

Figure-4

## ► **GROUND FAULT CIRCUIT INTERRUPTER (GFCI)**

A Ground Fault Circuit Interrupter is built in-line with the power supply cord to protect the operator from electric shock.

### 1. **GFCI Information.**

- Alpha® Wet Polisher is provided with an in-line GFCI as a standard accessory for your safety, and to prevent possible electric shocks. It is strongly advised to test the GFCI on a regular basis.

## **DANGER!**

**Never attach a damaged extension cord to the polisher.**

*NOTE: Use the appropriate extension cord, see table on page 9.*

## **CAUTION!**

When the GFCI trips, this could be the result of water entering the polisher housing.

1. Turn OFF the power switch, disconnect polisher from power supply and blow dry air inside the motor cover through the air vents.
2. Re-connect power supply and press the GFCI reset button. The polisher is ready to start working once the reset button is pressed down.

## **DANGER!**

Always check that the GFCI unit is working correctly (reset, test, and reset) before using this tool. Do not use the tool if the GFCI is not working correctly. Do not bypass the GFCI if this condition occurs, a real shock hazard may exist.

## **WARNING!**

If the GFCI fails to trip when the test button is pressed, or fails to reset, the device is defective and should be replaced.

## **CAUTION!**

1. The GFCI is a safety device, do not use as an on/off switch.
2. The GFCI on the tool will not protect you if you cut into another current carrying conductor.
3. Do not use where water may enter GFCI case.

► **TESTING IN-LINE GFCI UNIT** *(Before Each Use Of The Polisher)*

1. Connect polisher to a single phase AC power supply.
2. Verify that the indicator lens shows red (indicating output voltage).
3. Press the test button to verify that the red in the indicator lens disappears.
4. Press the reset button to verify the red indicator is visible.
5. The GFCI is now ready for use.

**⚠ WARNING!**

**DO NOT USE IF ABOVE TEST FAILS!**



Figure-5

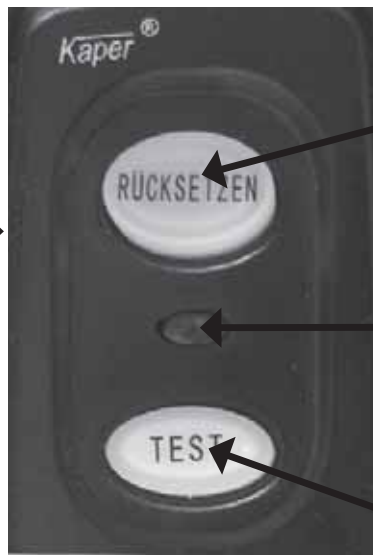

Figure-6

RESET BUTTON

Indicator viewing lens.  
RED lens shows power to  
polisher.

CLEAR lens shows no power  
to polisher.

TEST BUTTON

► **VARIABLE SPEED ADJUSTMENT**

This polisher is equipped with a Variable Speed control that will allow the spindle speed to be adjusted from 500 RPM to 2800 RPM. Speed adjustment is controlled by rotation of the wheel as shown in the Figure 4.

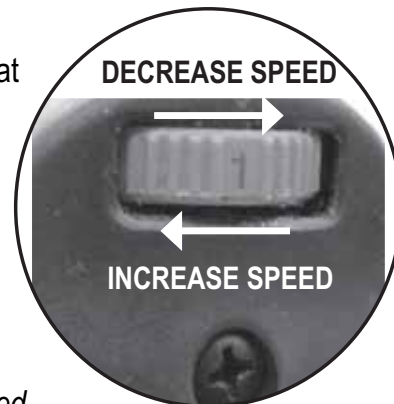

Figure-7

*NOTE- Wheel numbers are for reference point of motor speed (#1 is 500 RPM and #6 is 2800 RPM).  
Adjust the RPM of the tool to match the recommended RPM of the product being used.*

► **SPEED POT FEEDBACK SENSOR**

This polisher is equipped with a Closed Loop Feedback sensor that is attached to the speed pot. When a load is applied to the tool, the sensor will re-adjust the RPM to maintain a constant speed.

► **WATER CONTROL VALVE**

**⚠ CAUTION!**

Adjust the water flow to wet the stone and remove waste, excessive spray and mist will get inside the tool and cause premature failure of the tool and/or cause the GFCI to trip.

This polisher is equipped with a center water-feed system. Water flow to the spindle shower bolt can be controlled by throttling the valve stem as seen in Figure 8, Figure 9 and Figure 10.



Figure-8



Figure-9



Figure-10

## ► SIDE HANDLE INSTALLATION

### CAUTION!

During the use of Alpha® Core Bits and Profilers, use of the center handle is recommended. The center handle will allow the operator to have better control and ease of operation during these applications.

To switch from center handle to side handle, follow the steps below:



Figure-12

Remove both side screws from center handle.

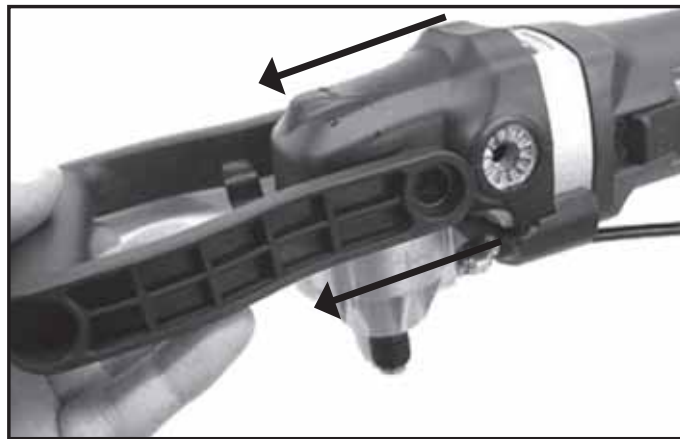

Figure-13

Pull handle forward and clear of polisher.

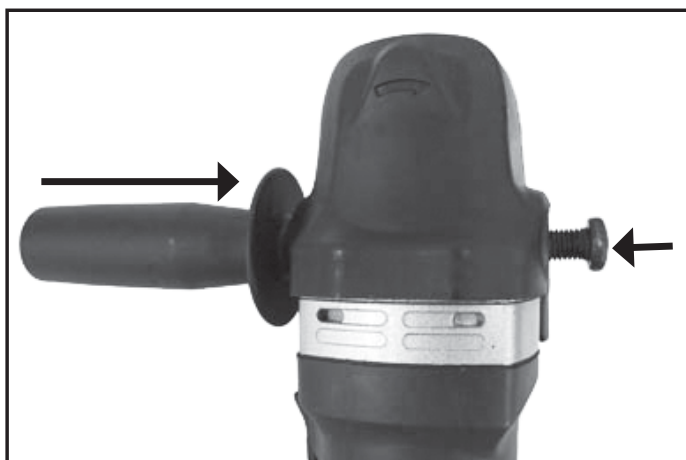

Figure-14

Thread the side handle into either the left or right side of the polisher, then thread one screw into the opposite side of the handle.



## ► CUSTOMIZING THE SPLASH GUARD

The splash guard can be cut to different heights according to the application to be performed.

**Cutting:** Using a pair of scissors or other cutting instrument, choose the desired height according to the application to be performed and cut along the grooved cut lines, as shown in Figure 15.

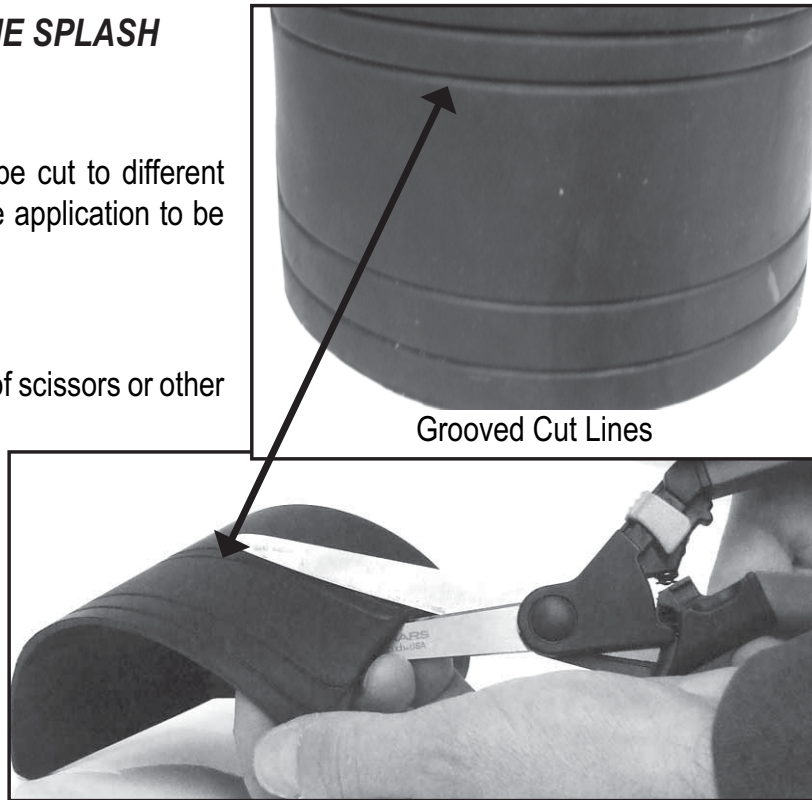

Figure-15

## RECOMMENDED HEIGHTS:

**Profiling:** When using Alpha® Profilers the splash guard can be used at its full height.

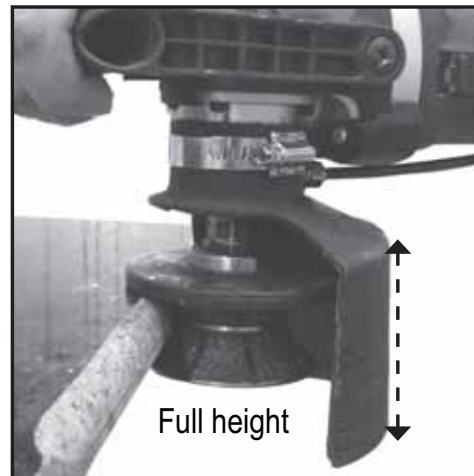

Figure-16

**Polishing:** When polishing, you may cut the splash guard at one of the grooved lines for easier access to the workpiece.

Splash Guard cut to accommodate polishing application

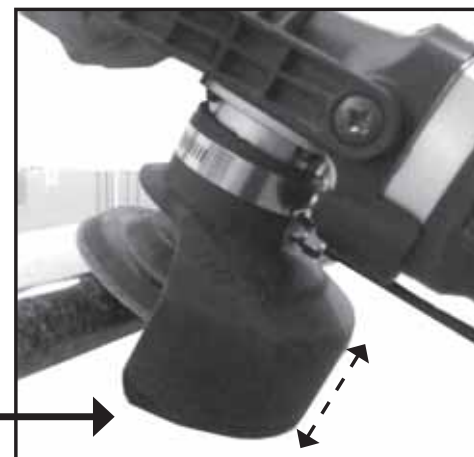

Figure-17

## ► SPLASH GUARD INSTALLATION

### CAUTION!

The splash guard should be used to prevent the water and dust from going inside the tool. Failure to do so can shorten the life of your tool and void the limited warranty.

1. Install the rubber splash guard into the tool so that the lip on the splash guard fits into the groove on the tool and the cutout is around the water fitting.

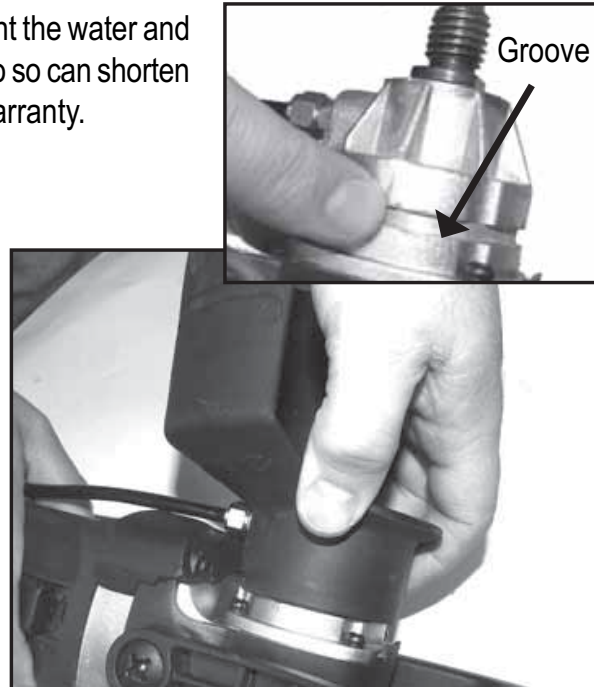

Figure-18

2. Open the band clamp completely and wrap around the splash guard under the water fitting.

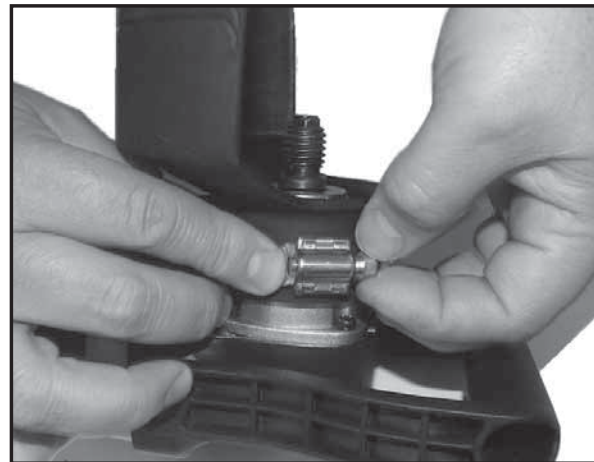

Figure-19

3. Tighten the clamp until snug.

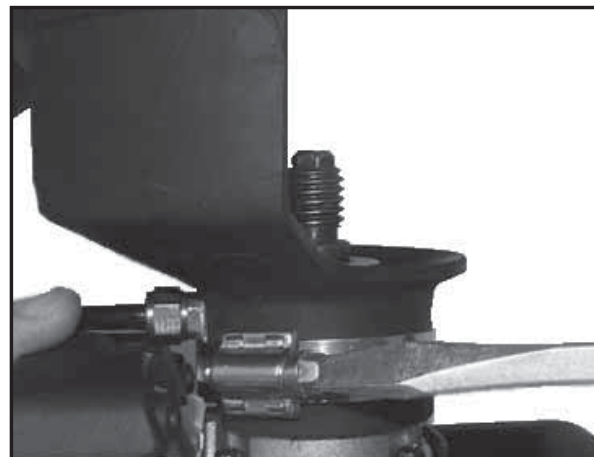

Figure-20

## ► PROFILER AND OTHER APPROVED SPINDLE ATTACHMENTS

### CAUTION!

Do not leave threaded accessories on the spindle of the tool for extended periods of time, as this may result in making it difficult to remove these accessories.

The VSP-230 polisher has a M14-2 center water-feed spindle thread.

To attach a profiler wheel or other approved spindle attachments, follow the steps below:

1. Screw the attachment onto the spindle by hand.

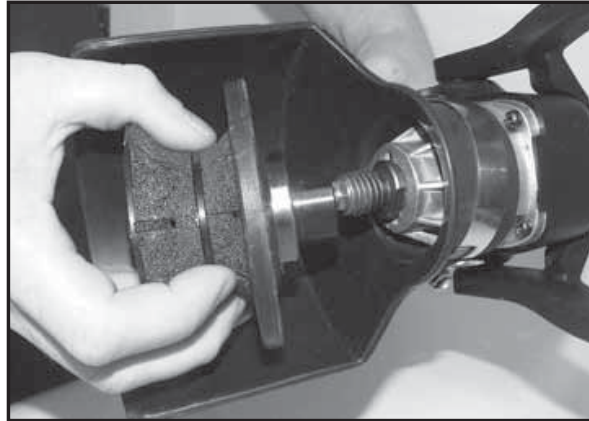

Figure-21

2. Tighten with supplied wrench.

*NOTE : If attachment does not thread on freely, check threads on both surfaces for damage or dirt. Clean, repair or replace as needed to ensure a safe and tight connection to the polisher.*

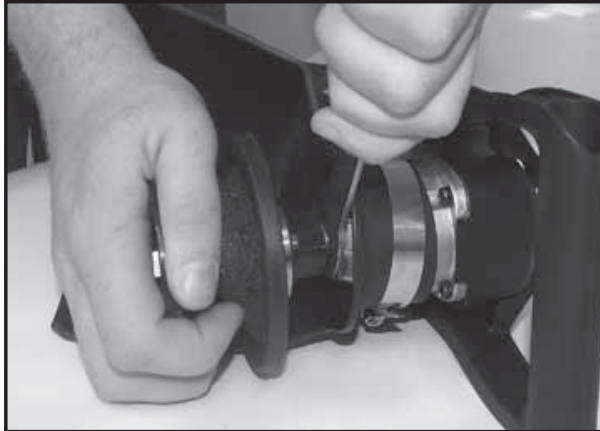

Figure-22

## ► WATER-FEED ATTACHMENT

Attach the polisher water-line fitting to any garden hose connection.

### OPERATION

### WARNING!

To reduce the risk of electric shock, check the tool's water supply system to ensure there is no damage to the seals or hoses. A damaged water supply system may result in abnormal water flow to the tool which could be dangerous.

 **CAUTION!**

Always wear safety goggles or a face shield during operation. Never switch on the tool when it is in contact with the workpiece, it may cause an injury to operator. Never run the tool without properly installed accessories.

Make sure that the water valve is closed. Connect the garden hose adapter to the water source. Make sure that water comes out when the water valve is opened. Hold the tool firmly. Turn the tool on and begin your application. Apply slight pressure only. Excessive pressure will result in poor performance and premature wear.

## MAINTENANCE

 **CAUTION!**

Always be sure that the tool is switched off and unplugged before attempting to perform inspection or maintenance.

► **DAILY**

1. Before daily start-up inspect tool, power cord, GFCI, and backer pad or other spindle attachments.
2. If damage has occurred, repair affected areas before use.
3. Connect the tool to the correct power source and test the Ground Fault Circuit Interrupter (GFCI) before using the tool. Push the RESET button and confirm that the red light is on, push the TEST button and confirm that the red run light is off and push the RESET button to use the tool.
4. Turn the unit on and run in a no-load condition to ensure that backer pad or other spindle attachment is balanced.
5. After daily use of the tool, clean and blow off the exterior of tool and around the rear air intake vents to remove any standing water or dust. Failure to do this will shorten the life of your tool, and could void your warranty.

► **PERIODIC**

 **WARNING!**

Preventive maintenance performed by unauthorized personnel may result in misplacing of internal wires and/or components which voids the warranty and could cause serious hazards. We recommend that tool service and repairs not covered in the manual be performed by an Alpha® Repair Center.

Periodic maintenance is done to check the tool and to minimize down time. These checks are done based on hours of operation and operating conditions. Operating condition can vary depending on the work surface and job being performed. If the tool is not used for a long period of time the carbon brushes should be checked and the commutator cleaned, before putting the tool back into operation.

### ► **BEARINGS AND GEARS**

To minimize your tool's down time and expensive tool repairs, it is recommended to send the tool back to an Alpha® Repair Center after about 300 to 400 hours of operation or every second carbon brush set change. The bearings should be replaced and the gears should be checked. If your tool starts to sound differently, this could be an indication of a worn bearing; continuing to use the tool in this condition could result in over heating or motor failure.

### ► **CARBON BRUSH REPLACEMENT**

Carbon brushes wear out over time, based on the polisher usage. If a carbon brush is worn out, it may cause the motor to malfunction or fail to run. Whenever the length of the carbon brush reaches the wear limit, replace with a new set.

*NOTE - To maintain even wear, both brushes should be replaced at the same time. The carbon brushes in this polisher are located underneath the Rear Cover (Part # 210053) as shown in Figure 23.*



Carbon brushes are located under the rear cover

Figure-23

► **REAR COVER REMOVAL**

1. Gently pull water tube away from holder.



Figure-24

2. Release the tube from the holder.



Figure-25

3. Unwrap 3 inches of the coiled harness.

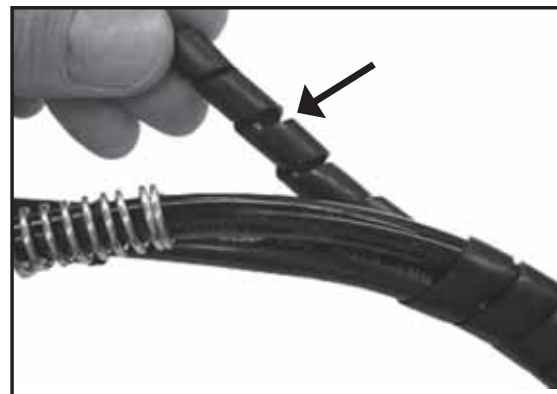

Figure-26

4. Remove the 2 screws from the valve bracket.

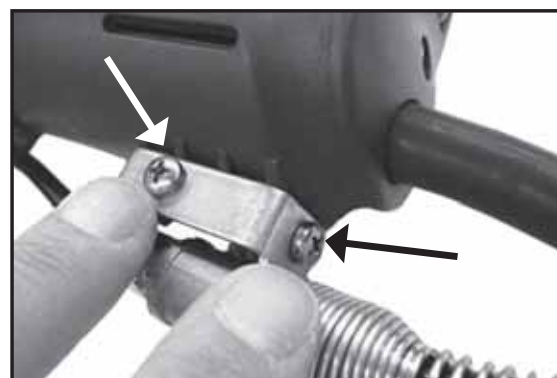

Figure-27

5. Pull the valve assembly away from mount.

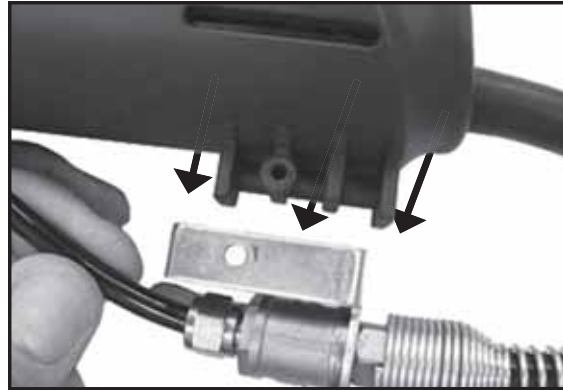

Figure-28

6. Remove the rear case screw.



Figure-29

7. Hold polisher with one hand and pull the rear case straight back with the other hand.

*NOTE: Do not twist case in a side to side motion when pulling back.*



Figure-30

8. Pull back the rear case until the carbon brush assembly is exposed.

*NOTE: Do not pull rear case further back from this point.*



Figure-31

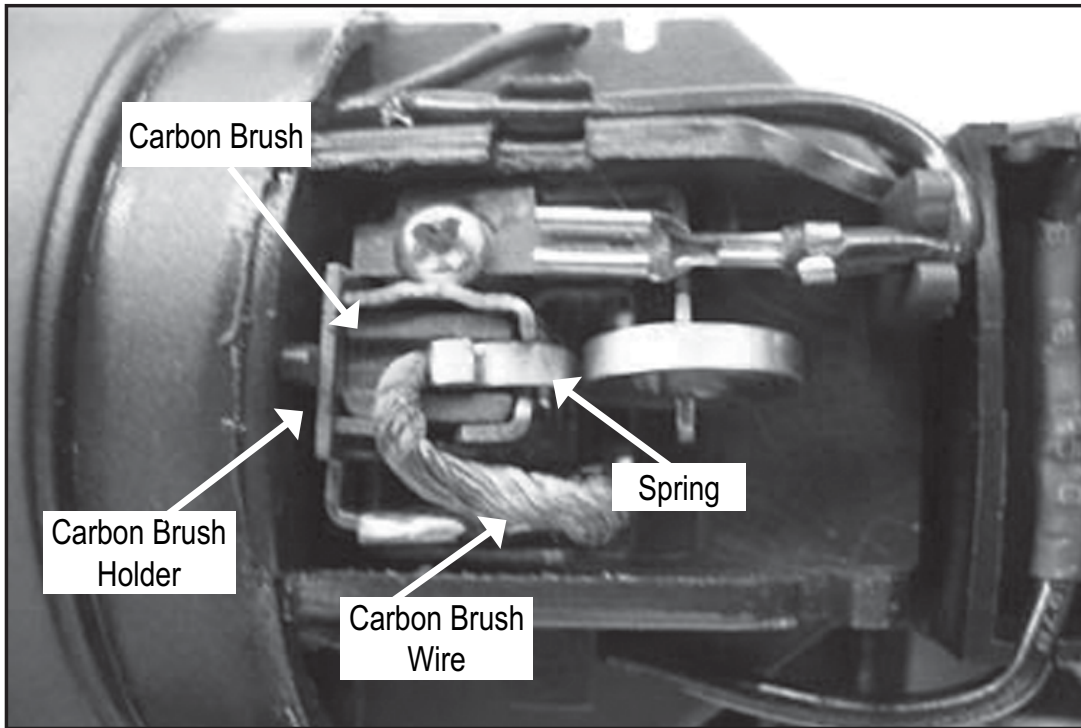

Figure-32

9. Lift the spring from the carbon brush and place on the side of the brush holder.

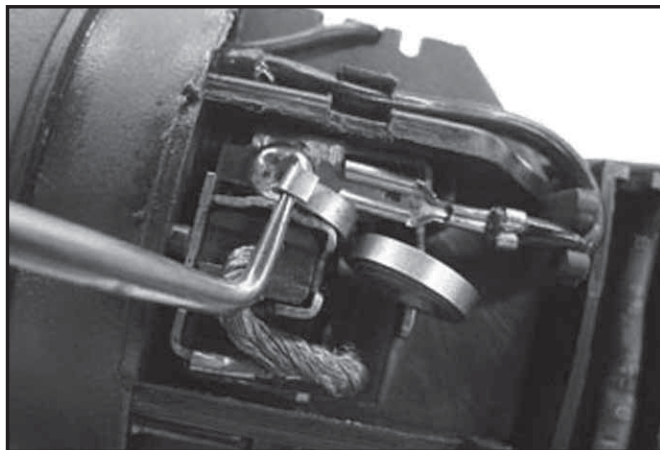

Figure-33

10. Remove the carbon brush wire spade connector from the terminal post and then remove the carbon brush.

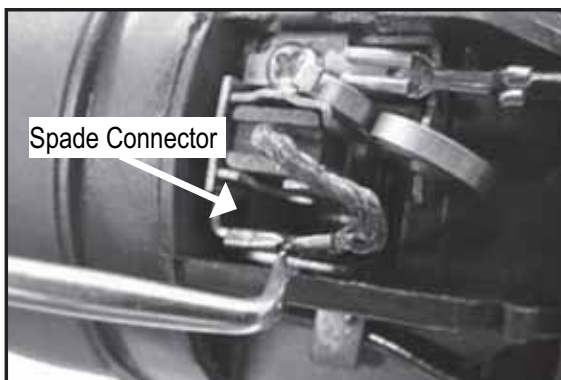

Figure-34

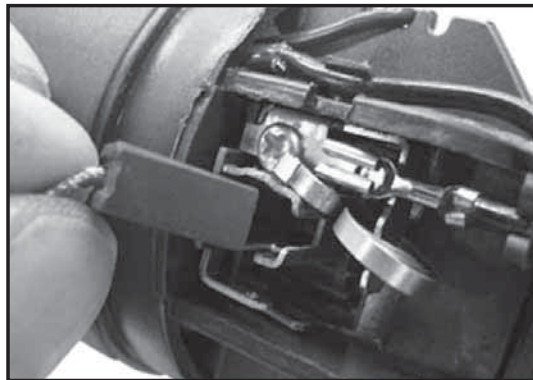

Figure-35



11. You can also remove the carbon brush by removing the screw and pulling the holder out with a pair of needle nose pliers.
12. With the carbon brush holder removed, you can check and clean the armature commutator. The commutator is the contact points that the carbon brushes ride on when the motor is running.

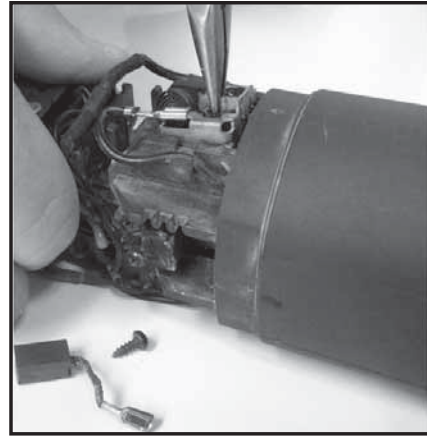
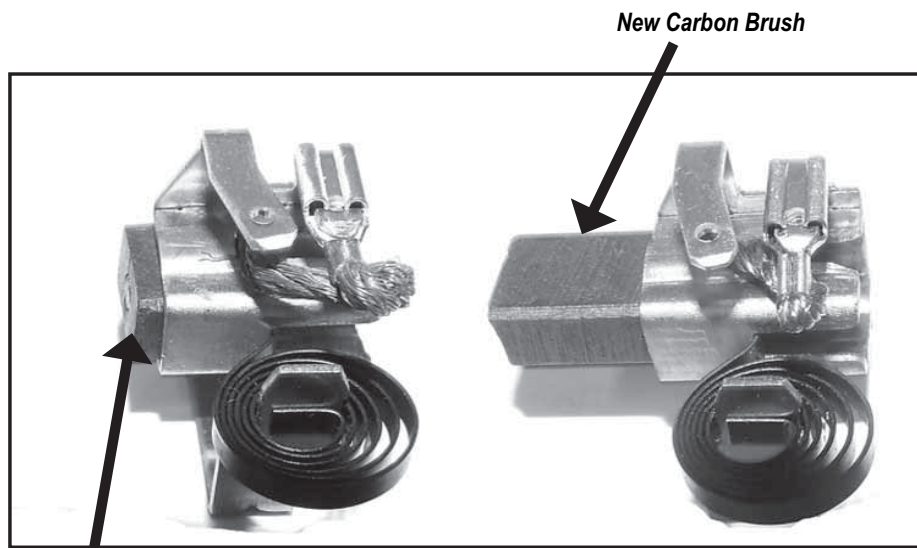

Figure-36

*NOTE: Each polisher has 2 carbon brushes located on opposite sides of each other. After the replacement of the two brushes, assemble the polisher by reversing disassembly procedure.*

13. Check the carbon brush for wear. Replace if worn down to a 6.4mm.



*Old Carbon Brush  
worn down to a quarter  
of an inch (6.4mm).*

Figure-37

14. Blow dust off of the spring and check for proper tension.
15. Remove the old carbon and disconnect the wire terminal wire. If the inside of the holder is filled with dust, clean before installing the new carbon brush. Upon installation of the new carbon brush, make sure the twisted wire is in the slot and behind the wire terminals on holder as in the photo above.

16. The commutator should be clean and shiny; if it is dull and black, you can clean it with a commutator cleaning stone.

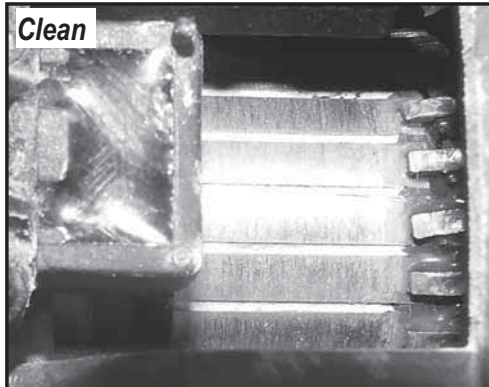

Figure-38

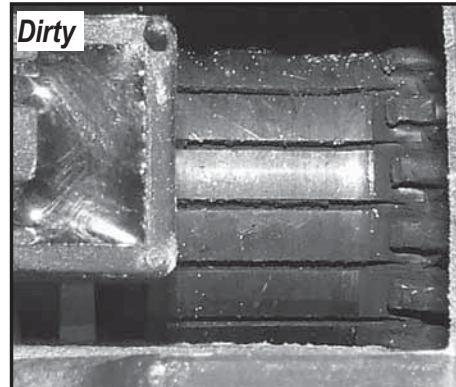

Figure-39

17. To clean the commutator, press the commutator cleaning stone against the commutator and rotate the armature by turning the spindle shaft by hand. Continue for a minute or until commutator is clean and shiny.

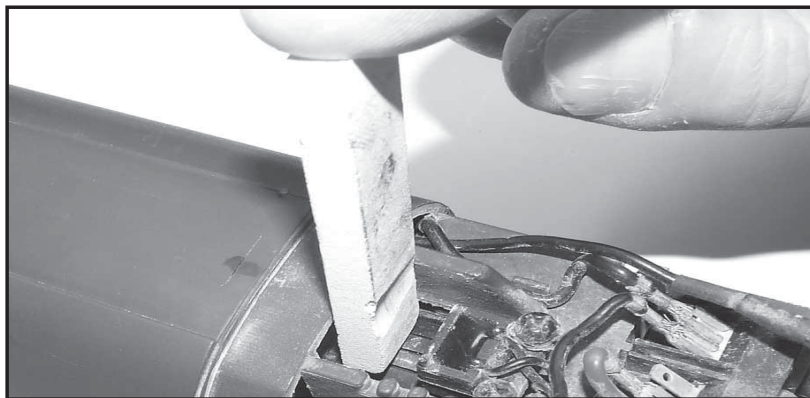
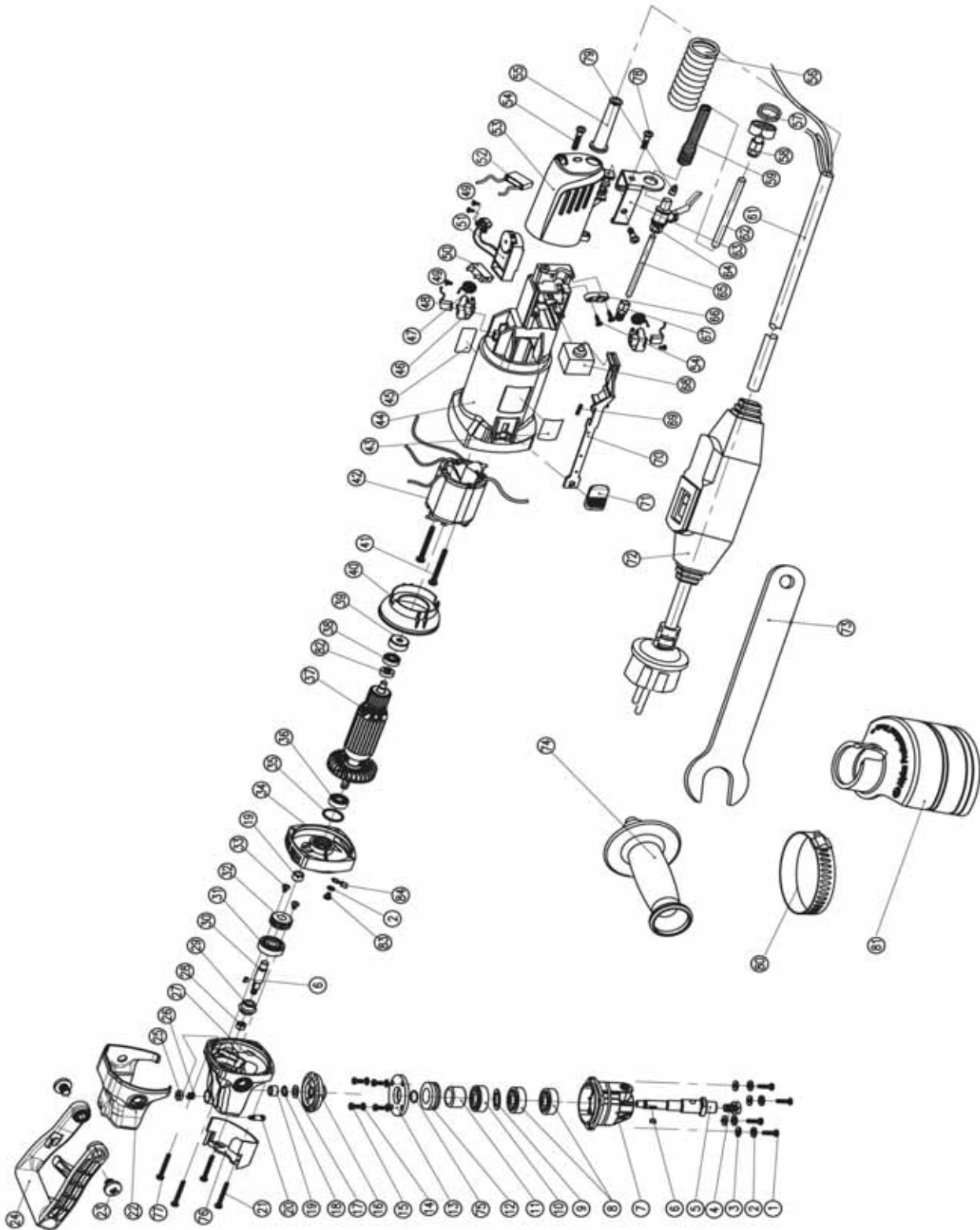

Figure-40

18. Reconnect the power wire, ensuring that the wire path is correct. Reinstall the carbon brush holder into the slot on motor housing and slide in until the tab for the screw hits the stop. Install the screw using light pressure to prevent it from stripping.
19. After both carbon brushes have been replaced you can reassemble the rear cover. Make sure the power wires are in the tool to prevent pinching of the wires.

# ALPHA® VSP-230 SCHEMATIC



## ALPHA® VSP-230 PARTS LIST

DRAWING NO.	PART NO.	DESCRIPTION	QUANTITY
1	210001	Screw M4x14	4
2	210002	Spring Washer 4	5
3	210003	Plain Washer 4	4
4	210004	Shower Bolt	1
5	210080	Output Shaft 230V (M14-2)	1
6	210006	Key 3x10	2
7	210090	Gear Case Cover	1
8	210008	Oil lip seal B16x28x7D	2
9	210009	Bearing Washer	1
10	210010	Ball bearing 6201	1
11	210011	Gear Washer	1
12	210012	Thrust Bearing 15x28x6	1
13	210013	Bearing Clamp	1
14	210014	Spring Washer 5	4
15	210015	Screw M5x16	4
16	210016	Gear	1
17	210017	Wave Spring Lock Washer 10	1
18	210018	"C" clip for Shaft 10	1
19	210019	Oil-impregnated Bearing 8x12x8	2
20	210020	Spindle-Lock Pin	1
21	210021	Self-tapping Screw 4.2x45	2
22	210022	Case Plastic Cover	1
23	210023	Screw M10x20	2
24	210024	C-Handle	1
25	210025	Lock Pin Cap	1
26	210026	Pin Spring	1
27	210027	Gear Case	1
28	210028	Anti-loose Nut M6	1
29	210029	Pinion Z3	1
30	210030	Transmitting Shaft	1
31	210031	Ball Bearing 6200	1
32	210032	Bevel Gear Z2	1
33	210033	Screw M4x8	2
34	210034	Bearing Retainer	1

# ALPHA® VSP-230 PARTS LIST

DRAWING NO.	PART NO.	DESCRIPTION	QUANTITY
35	210035	O-Ring 21.2x1.8	1
36	210036	Ball Bearing 608	1
37	210081	Armature 230V	1
38	210038	Ball Bearing 607	1
39	210039	Rubber Bearing Seat	1
40	210040	Windshield	1
41	210041	Self-tapping screw 4.2x70	2
42	210082	Field Coil 230V	1
43	210101	Brand Label	1
44	210091	Field Coil Case	1
45	210100	Data Label	1
46	210046	Carbon Brush Holder	2
47	210047	Coil Spring	2
48	210083	Carbon brush 230V (105S)	2
49	210049	Self-tapping screw 2.9x8	2
50	210094	Terminal Block	2
51	210098	Speed Pot w/Feed-Back Sensor 230V	1
52	210052	Capacitor 9.22F (for 230V version only)	1
53	210053	Rear Cover	1
54	210054	Self-tapping screw 4.2x14	3
55	210055	Cord Jacket	1
56	210056	Twist Strip	1
57	210057	Rubber Washer	1
58	210058	Garden Hose Adapter	1
59	210059	Spring	1
61	210085	Power Supply Cord 230V	1
62	133229	Water Hose 8mm ODx10ft (3m)	1
63	210063	Water Valve Bracket	1
64	210064	Water Valve Assembly	1
65	210065	Water Hose 6mm ODx8in (20cm)	1
66	210066	Cord Clamp	1
67	210067	Outlet Tap	1
68	210068	Switch	1
69	210069	Back Moving Spring	1

# ALPHA® VSP-230 PARTS LIST

DRAWING NO.	PART NO.	DESCRIPTION	QUANTITY
70	210070	Switch Push Lever	1
71	210071	Switch Push Button	1
72	210086	GFCI 230V (European)	1
73	210073	Wrench	2
74	210074	Side Handle	1
75	210075	O-Ring 15x2.65	1
76	210076	Dash Panel	1
77	210077	Self-tapping screw 4.2x40	2
78	210078	Self-tapping screw 4.2x10	2
79	210079	Water Valve Tap	1
(not shown)	210087	BMC (Blow Mold Case)	1
80	210088	Band Clamp	1
81	210089	Splash Guard	1
82	210095	Magnetic Ring	1
83	210096	Screw M4x8	1
84	210097	Terminal Connector	1

## **SERVICES AND WARRANTY INFORMATION**

### **► LOANER PROGRAM**

Loaner tools can be issued to temporarily replace a tool that is being returned to Alpha® for repair. If more than one tool is being returned for repair, the number of loaner tools provided will be based on availability.

If a loaner tool is required, contact Alpha® Tool Department at (800) 648-7229 to receive a Loaner Tool Application. A valid credit card number must be provided as a security deposit. The credit card will only be charged if the loaner tool is not returned to Alpha® within 30 days. An authorized signature is required for the credit card being used. A second signature is required as an agreement of the overall policy.

### **► NEED MORE INFORMATION**

For information on Alpha Professional Tools® complete product line, visit us on the web at [www.alpha-tools.com](http://www.alpha-tools.com)

► **ALPHA® TOOL REPAIR SERVICE**

For more information concerning Alpha® tool repair service, please contact the Alpha® repair centers listed below:

**COMPANY HEADQUARTERS:** Alpha Professional Tools®  
103 Bauer Drive  
Oakland, NJ 07436

**Hours of Operation:** 8:30 a.m. – 5:00 p.m. EST

**Telephone Number:** 201-337-3343

**Toll-Free Number:** 800-648-7229

**FACTORY SERVICE AND**

**TRAINING CENTER:** 3625 W. Teco Ave.,  
Suite #5  
Las Vegas, NV 89118

**Hours of Operation:** 7:30 a.m. – 4:00 p.m. PST

**Telephone Number:** 702-837-9515

**Toll-Free Number:** 888-292-5742

► **WARRANTY**

**Limited Warranty of Alpha® Wet Polisher**

Alpha Professional Tools® warrants this product against defects in material and workmanship for a period of 180 days from the date of original retail purchase (proof of purchase required). If Alpha Professional Tools® receives notice of such defects during the warranty period, our obligation assumed under this warranty is limited to the repair or replacement of parts, without charge. This warranty does not apply to tool accessories.

For Warranty Claims: Send complete tool with all your information and details of the problem to your nearest Alpha® Repair Center, transportation prepaid. Do not send tool accessories.

# EC DECLARATION OF CONFORMITY

Name of Manufacturer: Alpha Professional Tools®

Address of Manufacturer: 103 Bauer Drive  
Oakland, NJ 07436  
USA

Herewith declares that:

ELECTRIC HAND TOOL: "Alpha® Wet Polisher"

Make: Alpha Professional Tools®  
Type: VSP-230

-Does comply with the provisions of the Mechanism Directive 2006/42/EC and EMC Directive 2004/108/EC including the subsequent amendments.

And furthermore declares that:

-The following (parts/clauses of) harmonized standards have been applied:  
EN60745-1:2009, EN60745-2-3:2007, EN60745-2-3:2007/FprAC:2009, EN60745-2-3:2007/FprA1:200X, EN62233:2008, EN55014-1:2006, EN61000-3-2:2006, EN61000-3-3:1995+A1:2001+A2:2005, and EN55014-2:1997+A1:2001

Year of affix CE Marking: 2009

Dec / 2009

Oakland, New Jersey USA



Nao Takahashi  
(President)

## **Limited Warranty of Alpha® Wet Polisher for the USA and Canada ONLY!**

Alpha Professional Tools® warrants this product against defects in material and workmanship for a period of 180 days from the date of original retail purchase (proof of purchase required). If Alpha Professional Tools® receives notice of such defects during the warranty period, our obligation assumed under this warranty is limited to the repair or replacement of parts, without charge. This warranty does not apply to tool accessories.

For Warranty Claims: Send complete tool with all your information and details of the problem to the address printed on the cover of this manual, transportation prepaid. Do not send tool accessories.



# APPENDIX A

## ► FREQUENTLY ASKED QUESTIONS

- Q. What applications is the Alpha® VSP-230 recommended for?
- A. ***The Alpha® VSP-230 is recommended for wet polishing, wet core drilling, profiling and grinding.***
- Q. What is the warranty for this VSP-230?
- A. ***Alpha Professional Tools® warrants the VSP-230 against defects in material and workmanship for a period of 180 days from the date of original retail purchase (proof of purchase required). Please complete the warranty registration card upon receipt and mail immediately for prompt warranty service. Our obligation assumed under this warranty is limited to the repair or replacement of parts without charge. The warranty does not apply to tool accessories. The warranty for repairs is 30 days on the parts and labor.***
- Q. Does the VSP-230 have a maintenance program?
- A. ***Alpha Professional Tools® does not offer any type of maintenance program. However, we do recommend periodic checking and/or replacement of the carbon brushes for extended service life. If you should hear or detect unusual noise during the operation of the VSP-230, we recommend that you send it in to our repair department for some preventative maintenance.***
- Q. What is the RPM of the VSP-230?
- A. ***This polisher is a variable speed polisher with an RPM range of 500 – 2,800.***
- Q. What shall I do if my VSP-230 breaks down and I need to complete the job immediately?
- A. ***This largely depends upon the time frame involved. The first step would be to check and replace the carbon brushes. Alpha Professional Tools® has two warranty service centers and can turn your tool repair around in a 3-5 day period. Please contact Alpha® for information or send tool to your nearest regional repair center. For additional information or alternative solutions. please contact our tool repair department.***
- Q. The GFCI is tripping frequently. What I can I do?
- A. ***If the GFCI is tripping frequently, there could be several problems.***
- 1. Water is getting inside the polisher. Dry the tool with compressed air and try to prevent water from getting into the polisher.***
  - 2. The voltage drops due to sharing the same power source in a work area.***
  - 3. Too much force is applied to the tool. Back-off on the pressure.***
  - 4. The outlet may be loose. Make sure the power cord plug is tightly inserted in the power outlet.***
  - 5. Contact Alpha Professional Tools® tool repair department for further advice.***
- Q. If my VSP-230 breaks down, whom should I contact for repair?

- A. Contact the dealer where you purchased the tool or Alpha Professional Tools® directly at 800-648-7229.**
- Q. Can I use my VSP-230 as a wet cutting tool with a diamond blade?
- A. No. The VSP-230 only has a 2,800 no load RPM rating. This is not enough RPM for cutting applications with a diamond blade. It is unsafe to use the VSP-230 as a cutting tool. Do not attempt to cut with the VSP-230.**
- Q. Can I use my VSP-230 for dry polishing applications?
- A. No. The VSP-230 is designed for wet use only. Alpha® recommends using our AWP-158/214 for dry polishing applications.**
- Q. How can I get the parts list and schematic for the VSP-230?
- A. There are several ways to obtain information such as this from Alpha Professional Tools®. It is available on our website [www.alpha-tools.com](http://www.alpha-tools.com) or by contacting our Tool Dept Help Desk at 800-648-7229.**
- Q. What is the proper RPM for polishing Engineered Stone?
- A. Any RPM range on this polisher will work for polishing engineered stone. Using slower RPM together with the Alpha® Ceramica EX will provide the optimum polish on engineered stone material.**
- Q. What is the largest diameter accessory that the VSP-230 will accept?
- A. The VSP-230 will accept accessories up to 127mm. Do not attempt to use accessories larger than 127mm for safety reasons. In addition, large accessories require more torque than the VSP-230 can provide. Operating the VSP-230 under these conditions will result in overheating failure.**
- Q. Can I use the VSP-230 for drilling applications such as faucet holes?
- A. Yes. The VSP-230 can be used with Alpha® Core Bits to drill faucet mounting holes. We recommend using the provided C-Handle attachment and a template.**
- Q. How many liters of water does the Alpha® VSP-230 use per minute?
- A. The Alpha® VSP-230 has a throughput of approximately 4.2 liters per minute with the water valve fully open.**

### ► HELPFUL HINTS

1. If your VSP-230 does not start, check the carbon brushes for proper seating.
2. If the VSP-230 does not re-start, check and reset the GFCI.
3. Avoid dragging the VSP-230 on top of stone surfaces. The aluminum body may leave marks on the surface.
4. The C-Shape handle attached to the polisher is highly recommended for more stability of the polisher during certain applications such as: surface polishing, core drilling and profiling.

# PRODUCT REGISTRATION CARD

Model No.

Serial No.

Company Name: \_\_\_\_\_

Name: \_\_\_\_\_

Address: \_\_\_\_\_

City: \_\_\_\_\_ State: \_\_\_\_\_ Zip: \_\_\_\_\_

Telephone: \_\_\_\_\_

Purchase Date: \_\_\_\_\_

Dealer's Name: \_\_\_\_\_

**Note:** Serial & Model Number must be included for proper registration.



**Alpha Professional Tools®**

**(800) 648-7229**



Register online at:  
[www.alpha-tools.com/productregistration.aspx](http://www.alpha-tools.com/productregistration.aspx)

Mail or Fax to:  
Alpha Professional Tools®  
103 Bauer Drive, Oakland, NJ 07436  
Fax: 800-286-0114

Photocopy of product registration form will be accepted.



103 Bauer Drive, Oakland, NJ 07436 • 800-648-7229 • Fax: 800-286-0114  
[www.alpha-tools.com](http://www.alpha-tools.com)

Copyright © 2008 Alpha Professional Tools. All rights reserved.