

TURBINE FLOWMETER

USER'S MANUAL



HP-228

September 2015

H **HOFFER FLOW CONTROLS, INC.**
Perfecting Measurement™

107 Kitty Hawk Lane • P.O. Box 2145 • Elizabeth City, North Carolina 27906-2145

1-800-628-4584 • (252) 331-1997 • FAX (252) 331-2886

www.hofferflow.com • Email: info@hofferflow.com

NOTICE

Hoffer Flow Controls, Inc. makes no warranty of any kind with regard to this material, including, but not limited to, the implied warranties of merchantability and fitness for a particular purpose.

This manual has been provided as an aid in installing, connecting, calibrating, operating, and servicing this unit. Every precaution for accuracy has been taken in the preparation of this manual; however, Hoffer Flow Controls, Inc. neither assumes responsibility for any omissions or errors that may appear nor assumes liability for any damages that result from the use of the products in accordance with information contained in the manual.

HOFFER FLOW CONTROLS' policy is to provide a user manual for each item supplied. Therefore, all applicable user manuals should be examined before attempting to install or otherwise connect a number of related subsystems.

During installation, care must be taken to select the correct interconnecting wiring drawing. The choice of an incorrect connection drawing may result in damage to the system and/or one of the components.

Please review the complete model number of each item to be connected and locate the appropriate manual(s) and/or drawing(s). Identify all model numbers exactly before making any connections. A number of options and accessories may be added to the main instrument, which are not shown on the basic user wiring. Consult the appropriate option or accessory user manual before connecting it to the system. In many cases, a system wiring drawing is available and may be requested from Hoffer Flow Controls.

This document contains proprietary information, which is protected by copyright. All rights are reserved. No part of this document may be photocopied, reproduced, or translated to another language without the prior written consent of Hoffer Flow Controls, Inc.

HOFFER FLOW CONTROLS' policy is to make running changes, not model changes, whenever an improvement is possible. This affords our customers the latest in technology and engineering. The information contained in this document is subject to change without notice.

THIS WARRANTY IS EXPRESSLY IN LIEU OF ALL OTHER WARRANTIES, EXPRESSED OR IMPLIED, INCLUDING ANY IMPLIED WARRANTY OF MERCHANTABILITY OR FITNESS FOR A PARTICULAR PURPOSE. HFC SHALL NOT BE LIABLE FOR ANY LOSS OR DAMAGE RESULTING, DIRECTLY OR INDIRECTLY, FROM THE USE OR LOSS OF USE OF THE GOODS. WITHOUT LIMITING THE GENERALITY OF THE FOREGOING, THIS EXCLUSION FROM LIABILITY EMBRACES THE PURCHASER'S EXPENSES FOR DOWNTIME OR FOR MAKING UP DOWNTIME, DAMAGES FOR WHICH THE PURCHASER MAY BE LIABLE TO OTHER PERSONS, DAMAGES TO PROPERTY, AND INJURY TO OR DEATH OF ANY PERSONS. HFC NEITHER ASSUMES NOR AUTHORIZES ANY PERSON TO ASSUME FOR IT ANY OTHER LIABILITY IN CONNECTION WITH THE SALE OR USE OF HFC'S GOODS, AND THERE ARE NO ORAL AGREEMENTS OR WARRANTIES COLLATERAL TO OR AFFECTING THE AGREEMENT. *PURCHASER'S SOLE AND EXCLUSIVE REMEDY IS THE REPAIR AND/OR REPLACEMENT OF NONCONFORMING GOODS AS PROVIDED IN THE PRECEDING PARAGRAPHS. HFC SHALL NOT BE LIABLE FOR ANY OTHER DAMAGES WHATSOEVER INCLUDING INDIRECT, INCIDENTAL, OR CONSEQUENTIAL DAMAGES.*

LIMITED WARRANTY POLICY FOR HOFFER FLOW CONTROLS

HOFFER FLOW CONTROLS, INC. ("HFC") warrants HFC's Precision Series, API Series and CT Series of turbine flowmeters to be free from defects in material and workmanship under normal use and service, only if such goods have been properly selected for the service intended, properly installed and properly operated and maintained as described in the turbine flowmeter manual. Reference "turbine flowmeter manual" for specific details. This warranty shall extend for a period of five (5) years from the date of shipment to the original purchaser and covers the Precision Series, API Series and CT Series of flowmeters supplied with their standard hybrid ceramic ball bearings only. All other HFC products carry a one (1) year warranty. This warranty is extended only to the original purchaser ("Purchaser"). *Purchaser's sole and exclusive remedy is the repair and/or replacement of nonconforming goods as provided in the following paragraphs.*

In the event Purchaser believes the Hoffer product is defective, the product must be returned to HFC, transportation prepaid by Purchaser, within the appropriate warranty period relative to the product. If HFC's inspection determines that the workmanship or materials are defective and the required maintenance has been performed and, has been properly installed and operated, the product will be either repaired or replaced, at HFC's sole determination, free of additional charge, and the goods will be returned, transportation paid by HFC, using a transportation method selected by HFC.

Prior to returning the product to HFC, Purchaser must obtain a Returned Material Authorization (RMA) Number from HFC's Customer Service Department within 30 days after discovery of a purported breach of warranty, but not later than the warranty period; otherwise, such claims shall be deemed waived. See the Return Requests/inquiries Section of this manual.

If HFC's inspection reveals the Hoffer product to be free of defects in material and workmanship or such inspection reveals the goods were improperly used, improperly installed, and/or improperly selected for service intended, HFC will notify the purchaser in writing and will deliver the goods back to Purchaser upon receipt of Purchaser's written instructions and agreement to pay the cost of transportation. If Purchaser does not respond within thirty (30) days after notice from HFC, the goods will be disposed of in HFC's discretion.

HFC does not warrant the product to meet the requirements of any safety code of any state, municipality, or other jurisdiction, and Purchaser assumes all risk and liability whatsoever resulting from the use thereof, whether used singly or in combination with other machines or apparatus.

This warranty shall not apply to any HFC product or parts thereof, which have been repaired outside HFC's factory or altered in any way, or have been subject to misuse, negligence, or accident, or have not been operated in accordance with HFC's printed instructions or have been operated under conditions more severe than, or otherwise exceeding, those set forth in the specifications.

FOR **NON-WARRANTY** REPAIRS OR **CALIBRATIONS**, consult HOFFER FLOW CONTROLS for current repair/calibration charges. Have the following information available BEFORE contacting HOFFER FLOW CONTROLS:

1. P.O. number to cover the COST of the repair/calibration,
2. Model and serial number of the product, and
3. Repair instructions and/or specific problems relative to the product.

TABLE OF CONTENTS

WARRANTY PERIOD LISTED BY PRODUCT	1
INTRODUCTION	2
PRINCIPLE OF TURBINE FLOWMETER OPERATION	2
MATERIAL SELECTION AND CONSTRUCTION	2
BEARING SELECTION	3
FLOWMETER PICKUP SELECTION	3
FLOWMETER CALIBRATIONS	5
GENERAL INSTALLATION PROCEDURE	6
STRAINERS/FILTERS	8
FLOW STRAIGHTENERS and INSTALLATION KITS	9
SIGNAL CABLES	10
SIGNAL CONDITIONERS/CONVERTERS	10
PREVENTIVE MAINTENANCE AND TROUBLE SHOOTING	11
PICKUP COIL TESTING	11
BEARING REPLACEMENT	11
BEARING REPLACEMENT for THREADED SHAFTS	12
BEARING REPLACEMENT for NON-THREADED SHAFTS	13
BEARING REPLACEMENT for WING NUT (WECO) METERS	15
WEAR LIMITS for WING NUT (WECO) METERS	17
HO SERIES CALIBRATED SPARE OR REPLACEMENT	18
INTERNAL KITS	18
SPARE OR REPLACEMENT PICKUP COILS	18
PART NO. DESCRIPTION OF SERVICE TEMP. RATING	18
REDI-PULSE PICKUP COILS:	18
RECOMMENDED SPARE AND REPLACEMENT PARTS	19
STORAGE OF THE TURBINE FLOWMETER	20
ADDENDUM: INSTALLATION OF CSA EXPLOSION PROOF CERTIFIED PRODUCT	21
APPENDIX A – HAZARD ANALYSIS	23
APPENDIX B – PRESSURE EQUIPMENT DIRECTIVE (PED)	26
APPENDIX C – DRAWINGS	27

WARRANTY PERIOD LISTED BY PRODUCT

5 Year Limited Warranty
API Precision HO Series – Excluding pickup coils Liquid Precision HO Series – Excluding pickup coils Gas Precision HO Series – Excluding pickup coils CT Custody Transfer Series – Excluding pickup coils

1 Year Limited Warranty		
Type	Series	Service
Sanitary	HO	Liquid
Star/Industrial	HO	Liquid
Teflon	HO	Liquid
Mini-Flowmeter	MF	Liquid & Gas
Insertion	HP	Liquid & Gas
Wing Nut*	HO	Liquid
Grooved	HO	Liquid
PD Meters	HOG	Liquid
OEM	Lo-Co	Liquid
Pickup Coils	All	
Signal Conditioners, Converters & Electronic Accessories	All	
Flowstar & Nova-Flow Series Flow Computers	All	
ACE & ACE II	All	
Digital & Analog Totalizers/Rate Indicators.		
Electronic Spares/Cables & Replacement parts.		
All outside purchased items such as: Valves, Strainers, Pressure & Temperature Transmitters.		

***Note:** *Turbine flowmeters are ideally suited for service in clean liquid and gas service. Certain Hoffer turbine flowmeter series may be enhanced for use in slurry type flow applications. The flowmeter internals will eventually wear when the turbine flowmeter is installed in a “dirty” type of flow application. The rate of wear is a function of flow velocity, the type of slurry service, and the percentage of particulate to liquid. HFC is unable to predict the life of the flowmeter internals for slurry applications. Our standard product warranty does not apply for flowmeters that will be used in slurry type applications.*

INTRODUCTION

We are proud that you have selected a Hoffer Turbine Flowmeter, the finest precision turbine flow transducer on the market.

The Hoffer Turbine Flowmeter has been designed, constructed, and selected for your application with care by a qualified staff of professional engineers, technicians, and sales personnel.

We welcome you to our growing family of satisfied customers. If you are not completely satisfied with either our product or service, we encourage you to let us know. We want to improve!

The following information is provided for the proper installation and maintenance of your instrument.

PRINCIPLE OF TURBINE FLOWMETER OPERATION

The flowmeter is a volumetric measuring turbine type.

The flowing fluid engages the vaned rotor causing it to rotate at an angular velocity proportional to the fluid flow rate.

The angular velocity of the rotor results in the generation of an electrical signal (AC sine wave type) in the pickup. The summation of the pulsing electrical signal is related directly to total flow. The frequency of the signal relates directly to flow rate.

The vaned rotor is the only moving part of the flowmeter.

MATERIAL SELECTION AND CONSTRUCTION

Hoffer Turbine Flowmeters are available in a broad range of standard and special materials. The wide range of construction options allows for the selection of the optimum combination of useful range, corrosion resistance, and operating life for a particular application. A low mass rotor design allows for rapid dynamic response which permits the turbine flowmeter to be used in pulsating flow applications. The deflector cones eliminate downstream thrust on the rotor and allows for hydrodynamic positioning of the rotor between deflector cones.

The hydrodynamic positioning of the low mass rotor provides wider rangeability and longer bearing life than that of conventional turbine flowmeters. Integral flow straightening tubes minimize the effects of upstream flow turbulence.

The housing is made of nonmagnetic materials. The rotor is made of magnetic or magnetized material. Bearings are chosen based on service fluid, cost, and accuracy considerations.

Standard materials of construction are 316 stainless steel for the flowmeter body and rotor supports. The rotor materials of construction include 17.4 pH SS, NICKEL 200 and 430 SS. Many special materials are available for meter construction, some of which include teflon, 4130 steel, monel, other grades of stainless steel, hastalloy, titanium, tantalum, and numerous other exotic materials.

Selection of the materials of construction is usually dictated by requirements of media compatibility, availability, and cost considerations.

The materials supplied in your flowmeter have been selected for the best service of your application.

BEARING SELECTION

Numerous bearing types are available including ball bearings and sleeve type construction in tungsten carbide, Teflon, and carbon graphite composite.

When selecting among several chemically compatible bearings, the ball bearing design offers the highest accuracy and generally will have the widest usable range. It remains the bearing of choice in many fluids and is required for gas flowmeters.

Tungsten carbide bearings offer the most durable bearing material for service fluids in which it is compatible. These represent the standard bearing type for many industrial service environments.

Teflon and carbon graphite composite bearings offer properties which are nearly chemically inert to many corrosive fluids and are utilized primarily for this reason.

In turbine flowmeters, the flowing fluid provides the bearing lubrication in most applications. It may be observed that fluids which offer a high natural lubricity tend to prolong the life of the flowmeter. Many bearing types offer advantages in that they provide self-lubrications as well as providing a wear resistant surface. Among these bearing materials are carbon graphite composites, teflon, and some ball bearing designs.

Bearing life has been found to be approximately inversely proportional to the square of the bearing speed. To prolong the life of the flowmeter, it is therefore advantageous to operate the flowmeter at rates less than the maximum flowrate. For example, if the flowmeter is operated at 1/3 of the maximum flowrate, it will wear at approximately 1/10 the rate.

The bearings in your flowmeter have been selected by our staff based on what we have found to be the best choice for your application.

FLOWMETER PICKUP SELECTION

The flowmeter pickup senses the motion of the rotor and converts it to a pulsing electrical signal which is of a discrete, digital nature.

Hoffer Flow Controls offers several pickup types suited for different applications. The advantages of each are listed.

HIGH OUTPUT MAGNETIC PICKUP - TYPICAL RANGE 10:1

The standard pickup for turbine flowmeters larger than 1 inch produces a high level sinusoidal output. To produce this, the pickup generates a relatively high magnetic field. The signal may be transmitted up to 200 feet without amplification. A flow range of 10:1 or better is common with this pickup type.

LOW DRAG MAGNETIC PICKUP - TYPICAL RANGE 25:1

Low drag magnetic pickups may be used to obtain a flowmeter range of 25:1 or better. They offer a significant reduction in drag effects with lower output levels and may require pre-amplification prior to transmission. Low drag magnetic pickups are used extensively in meter sizes below 1 inch.

MAGNETIC PICKUP OUTPUT SIGNAL CHARACTERISTICS

The output signal voltage of the magnetic coil is approximately sinusoidal. The frequency range of the pulsing signal varies from meter size to meter size. However, standard ranges allow for maximum output frequencies at the nominal linear flow of 250, 500, 750, 1000, 1500, 2000, and 2500 Hz.

The amplitude of the output signal is a function of flowrate. The voltage at the minimum linear flow is greater than 30 millivolts peak to peak when measured into a 10,000 ohm load.

On larger size flowmeters the output level may exceed several volts peak to peak. The DC output resistance of the magnetic pickup coil is generally less than 2,000 ohms. Detailed impedance characteristics are available on request.

MODULATED CARRIER PICKUP (MCP) - TYPICAL RANGE 100:1

The Hoffer MCP pickup is an active coil which eliminates pickup drag and requires a Modulated Carrier Signal Conditioner be mounted on or near (10 feet or less) the flowmeter. The MCP works on a principle where the motion of the rotor modulates a high frequency signal. The conditioner demodulates, filters, amplifies, and shapes the resulting signal prior to transmitting it as a high level signal. Use of the MCP pickup allows for wider flow ranges than can be achieved with low drag magnetic pickups. The cost compares with that of a preamplifier for a magnetic pickup. This pickup type is used extensively when a wide flow range is required or with flowmeters that are being used with a universal viscosity calibration curve (UVC). Typically, MCP coils can obtain flowmeter ranges of up to 100:1.

QUADRATURE OUTPUT OPTION

When a Hoffer Turbine Flowmeter is equipped with two pickup coils properly positioned on the flowmeter housing, it is possible to sense flow direction, flowrate and total flow as well as add/subtract options.

The pickup coils generate two output signals with a quadrature (90°) phase difference. With suitable electronic phase discriminating circuitry, it is possible to provide two separate output signals, one of which is related to flow in the forward direction only, with the second relating to flow in the reverse direction only.

Hoffer Turbine Flowmeters, unlike many other turbines, are built physically symmetrical which inherently makes bi-directional flow measurement possible with only the addition of a second pickup coil, keeping cost considerably less than other manufacturers. Other considerations which may dictate equipping two pickup coils on a single flowmeter arise from advantages in the ease of achieving parallel signal processing or increased reliability.

HAZARDOUS AND WEATHERPROOF ENVIRONMENTAL COIL ENCLOSURES

The explosion proof requirements of UL Class I, Group C and D, Class II, and NEMA 4X are routinely provided for by enclosing the pickup coil in a suitable housing. Signal conditioners and converters can readily be mounted on the flowmeter. Hoffer Turbine Flowmeters are inherently safer since they require no through holes eliminating the possibility of a leak.

FLOWMETER CALIBRATIONS

The standard calibration provided with most Hoffer Turbine Flowmeters consists of a 10-point water calibration over the linear flow range of the meter. A number of optional flowmeter calibrations may also be requested.

A 10-point water calibration over the extended range of the meter may be requested at no additional charge. Additional calibration points may be requested within the linear range or in the extended range at additional cost.

Fluids other than water are used to simulate viscosity conditions from 2 to 300 centistokes. Where it is necessary to document flowmeter performance for viscous service, the flowmeter calibration simulates the viscosity, as well as, the flow rate anticipated in actual service.

Universal Viscosity Calibration (UVC) curves may be documented for each Hoffer Turbine Flowmeter where this information is required to achieve maximum flowmeter accuracy in medium to high viscosity service.

In general, any flowmeter size may be supplied with a UVC. However, since smaller meter sizes (under one inch) display the largest sensitivity of calibration factor to viscosity, it is this size range which is the most likely to be considered for a UVC.

The UVC may be utilized to determine the K-Factor either graphically, or in the case of an intelligent instrument, algorithmically, for a measured set of flowing conditions.

Hoffer offers a standard viscosity calibration which consists of ten repeated points for each viscosity required. A typical UVC curve requires three sets of ten points plotted as a continuous curve. In addition, Hoffer offers a ten point single viscosity (up to 300 centistokes) calibration at a nominal additional fee.

GENERAL INSTALLATION PROCEDURE

Upon receipt of the turbine flowmeter a visual inspection should be performed checking for any indications of damage which may have occurred during shipment. Inspect all packing material carefully to prevent the loss of meter parts or auxiliary components which may have been packed with the shipment. Refer to the packing list/invoice for a detailed list of items included in the shipment.

The meter housing is marked by a flow direction arrow and the inlet is marked 'IN' and the outlet is marked 'OUT'. The meter must be installed in the piping in the correct orientation to ensure the most accurate and reliable operation. Care should be taken in the proper selection of the mating fittings. Size, type of material, and pressure rating should be the same as the flowmeter supplied. The correct gaskets and bolts should be utilized.

The flowmeter may be installed horizontally or vertically for liquid service without affecting the meter calibration, however, in gas applications the meter must be installed horizontally for proper operation. When it is expected that flow will be intermittent, the meter should not be mounted at a low point in the piping system. Solids which settle or congeal in the meter may affect meter performance.

In order to achieve optimum electrical signal output from the flowmeter, due consideration must be given to its isolation from ambient electrical interference such as nearby motors, transformers, and solenoids.

GENERAL PIPING CONSIDERATION

As stated in the Principle of Flowmeter Operation, the fluid moving through the flowmeter engages the vaned rotor. Swirl present in the fluid ahead of the meter can change the effective angle of engagement and, therefore, cause a deviation from the supplied calibration (performed under controlled flow conditions). Turbine meters are constructed with flow straighteners to minimize the affects of fluid swirl and non-uniform velocity profiles is adequate for most installations. However, it is good practice to maintain a minimum straight run of pipe approximately 10 pipe diameters ahead of the inlet and 5 pipe diameters following the outlet. Proper installation of the flowmeter minimizes the negative effects of fluid swirl.

A typical flowmeter installation is shown below:

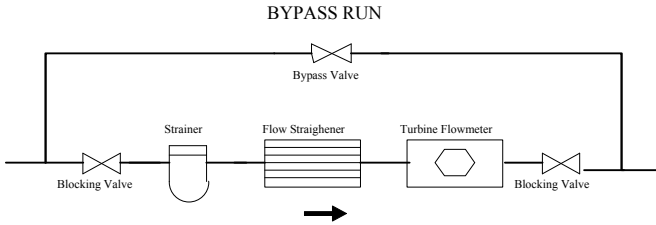

Figure 1: Typical Flowmeter Installation

Blocking and Bypass valves should be installed if it is necessary to do preventive maintenance on the flowmeter without shutting down the flow system. The Bypass valve can be opened before the Blocking valves allowing the flow to continue while removing the turbine flowmeter for service.

IMPORTANT: *All flow lines should be purged prior to installing the meter. To prevent possible damage to the meter, install the meter **ONLY** in flow lines that are clean and free of debris.*

Upon initial start-up of the system a spool piece should be installed in place of the flowmeter so that purging of the system can be performed to remove all particle debris which could cause damage to the meter internals. In applications where meter flushing is required after meter service, care should be taken as to not over-speed the meter, as severe meter damage may occur.

CAUTION: *Avoid over-spinning the meter. Over-spinning the meter may cause damage to the meter internals and lead to needless meter failure.*

To maintain an accurate flow measurement it is necessary to maintain a downstream pressure sufficient to prevent flashing/cavitation. Flashing of the liquid will result in an indication of flow significantly higher than the actual flow. In order to eliminate this condition adequate downstream pressure must be maintained. The minimum required downstream pressure may be calculated using the following equation:

$$\text{Minimum Pressure} = (2 \times \text{Pressure Drop}) + (1.25 \times \text{Vapor Pressure})$$

Downstream pressure may be maintained by a downstream valve that provides the necessary downstream pressure to prevent flashing/cavitation in the metering run.

STRAINERS/FILTERS

Turbine flowmeters are designed for use in a clean fluid service. However, the service fluid may carry some particulate material which would need to be removed before reaching the flowmeter. Under these conditions a strainer/filter may be required to reduce the potential hazard of fouling or damage that may be caused by foreign matter. Strainer/filters are recommended to be used with the Hoffer Mini-Flow Series meters.

METER SIZE	MESH SIZE	PARTICLE SIZE (Maximum)
MF Series	100	.0055
1/4" to 1/2"	100	.0055
5/8" to 1 1/4"	70	.008
1 1/2" to 3"	40	.015
4" to 12"	24	.028

If a strainer/filter is required in the system, it should be located upstream of the flowmeter taking care that the proper minimum distance is kept between the strainer and flowmeter.

FLOW STRAIGHTENERS and INSTALLATION KITS

FLOW STRAIGHTENING

Proper application of the Hoffer Turbine Flowmeter requires a suitable piping section to achieve optimum accuracy. While an inlet straight pipe run of 10 pipe diameters and an outlet straight pipe run of 5 pipe diameters provide the necessary flow conditioning in general, some applications require an upstream flow straightener. This consists of a section of piping that contains a suitably dimensioned and positioned thin walled tube cluster to eliminate fluid swirl.

Figure 2 Typical Flow Straightener

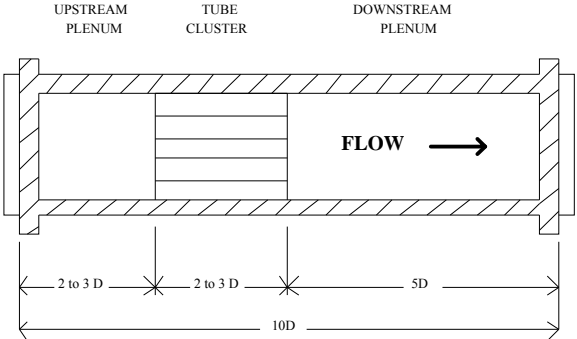

A typical application requiring a flow straightener would be custody transfer.

Flanged flow straightening sections are available from 1/2" to 12" line sizes with mating fittings in pressure ratings from 150# to 2500# ratings. Beveled type end fittings for welding are also available.

MS INSTALLATION KITS

Installation kits for the MS end fittings consist of two lengths of stainless steel tubing cut to a length appropriate for the upstream and downstream straight pipe run and flared at one end. Mating sleeves and nuts are included. The kits may be conveniently butt welded into the user's piping. Alternately the kits may be provided with NPT or flanged connections to facilitate installation of smaller flowmeters into larger existing lines. This adapted form of the installation kit is recommended for use with the Hoffer Mini Flowmeters since only MS end fittings are offered in the Mini Flow Series.

Flow straightening sections may be provided within the installation kit.

MS installation kits are available in turbine sizes from 1/4" to 2".

SIGNAL CABLES

Two conductor shielded cabling recommended for the Hoffer Turbine Flowmeter is generally available in most industrial settings. However, Hoffer stocks cabling for user convenience. Cabling is available cut to length with dressed end connections. Recommended cable is Beldon 8422 or equal.

SIGNAL CONDITIONERS/CONVERTERS

Consideration should be given to properly interface the turbine flowmeter output to the host electronics. If the system is installed in an electrically noisy area or if the distance from the turbine flowmeter to the host electronics exceeds 500 feet a signal conditioner may be necessary.

Hoffer Signal Conditioners for the turbine flowmeter provide amplification, filtering, and wave shaping of the low level flowmeter pickup signal and generate a high level pulse output signal suitable for transmission to a remote host system through a noisy environment.

Several output forms (i.e., TTL/CMOS, open collector, etc.) are available to suit various interface requirements. The conditioned pulse output signal may be transmitted several thousand feet.

Note: The standard (1) year warranty applies to all coils, signal conditioners/converters and Hoffer electronics.

PREVENTIVE MAINTENANCE AND TROUBLE SHOOTING

PICKUP COIL TESTING

Testing the MAG and MCP (RF) coils consists of measuring the resistance with an ohmmeter.

1. Measure the resistance between pin A and pin B. The resistance should be approximately as listed in the following table.
2. The resistance from any pin to the case should be greater than 1 megohm.

Table A - DC Resistance of some common coils*

COIL	DC RESISTANCE
	(Ohms)
MC2PAHT	15.0 ±10%
MCP	2.5 ±10%
MCP3A	11.5 ±10%
PC13-110G	1800 ±10%
PC13-70G	1800 ±10%
PC13-74G	1800 ±10%
PC13-74S	1850 ±15%
PC24-45G	1350 ±10%
PC24-45S	1850 ±15%
PC28-13G	120 ±20%
PC28-14G	180 ±20%

If either resistance measurement fails, replace the pickup coil. Firmly seat the new coil in the flowmeter.

BEARING REPLACEMENT

The type of bearings installed in the flowmeter have been selected to operate in the type of service being metered.

It is recommended that the bearings be checked periodically for wear. The type of fluid being measured, as well as temperature and cleanliness of the service, have a direct relationship on the life expectancy of the bearings. Therefore, it is best to contact the engineering department or the HFC Customer Service department for the proper preventive maintenance interval.

It is recommended that the bearings be replaced if any signs of wear are apparent. An unexplained shift in the output accuracy could be a sign of worn bearings.

* For specific coils not listed contact the HFC Customer Service Department for the approximate resistance readings.

CAUTION: *If bearings are allowed to operate without replacement at the recommended interval, the accuracy of the device may drift from the original calibration and if left long enough severe damage to the rotor and/or internals may occur.*

Ball bearings can be changed in the field. Sleeve type bearings can not be changed in the field. If no down time can be tolerated, a spare rotor with sleeve bearing or complete set of spare internals should be stocked.

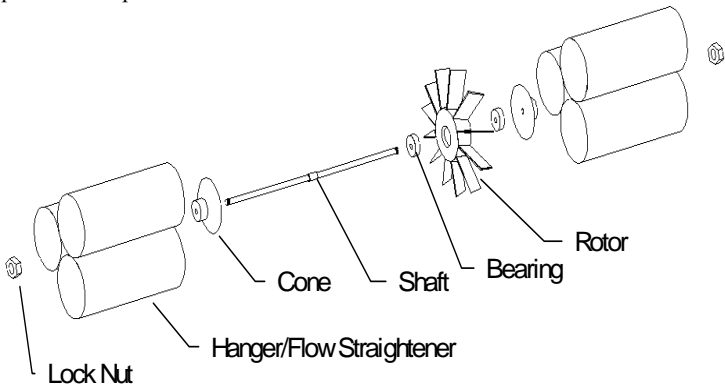

Figure 3 Exploded View - Flowmeter Internals

BEARING REPLACEMENT FOR THREADED SHAFTS

1. Remove the meter to a clean stable work surface.
2. Using two “Spin-Tite” wrenches, remove one lock nut from the shaft.
3. Place a small head stove bolt in a vise. Guide the bolt head gently through one of the hanger/flow straightener tubes and in a smooth firm stroke remove the hanger from the housing.
4. With the shaft placed vertically downward, carefully remove a cone, two bearings, and the rotor.
5. Remove the other hanger in a similar manner.
6. Examine the shaft and cones for scoring. If scoring is present, replacement is necessary.
7. Obtain new bearings of the same type from stock or the manufacturer. Discard old bearings.
8. Reassemble one hanger in the housing with the shaft, a cone, and lock nut.
9. Place the bearings into the rotor. Guide the bearings and rotor onto the shaft making sure to reassemble with the “IN” side of rotor facing the “IN” side of the housing.
10. Place the remaining cone on the shaft. Gently “rattle” the flowmeter to seat the internals on the shaft.

11. When properly seated, gently push the hanger onto the shaft. Be sure to properly align the hanger on the shaft. The hangers seat against a shoulder machined into the housing.
12. Gently tighten the self-locking lock nuts until they make contact with the spring clip hanger. “Two Finger” tight on a “Spin-Tite” is more than adequate.
13. Holding the meter horizontally, gently blow into it (DO NOT use compressed air). The rotor should turn freely. With a magnetic coil the rotor should gradually slow down and then “quiver” to a stop with one of its blades aligning with the pickup coil. With a MCP (RF) coil the rotor should “coast” smoothly to a stop.
14. Clean the flowmeter assembly with ISOPROPYL ALCOHOL or an alternately approved cleaning solution.

The flowmeter is ready for service. When installing the flowmeter be sure to orientate the in and out correctly.

BEARING REPLACEMENT FOR NON-THREADED SHAFTS

1. Remove meter to a clean stable work surface.
2. Insert the hanger tool (3P-Tool HFC Stock # 300-8113) into the hanger/flow straightener assembly.
3. Turn the 3P-Tool until the hanger tubes are aligned with the scallops in the meter housing.
4. Holding the meter in the vertical direction slowly remove the tool. The hanger, shaft, cones, rotor, and bearings should come out with the tool. Should any of the components hang-up inside the meter housing care should be taken in their removal.
5. Remove the remaining hanger in a similar manner.
6. Examine the shaft and cones for scoring. If scoring is present, replacement is necessary.
7. Obtain new bearings of the same type from stock or the manufacturer. Discard old bearings.
8. Insert the shaft with cone into the hanger and assemble the remaining internal parts onto the shaft.
9. Place the hanger assembly with the internals on the 3P-Tool.
10. Hold the housing in the vertical position and align the hanger assembly with the scallops in the meter housing.
11. Gently slide the hanger and rotor assembly into the housing with the “IN” on the rotor oriented in the same direction as the “IN” on the housing.
12. When the hanger assembly is fully inserted into the meter housing, twist the 3P-Tool to secure the hanger in the ‘locked’ position.
13. Align the second hanger with the scallops on the housing and with the shaft.

Caution: *It is very important that the shaft is properly inserted into the second hanger. Failure to do so will result in damage to the rotor, shaft, and/or bearings.*

14. With the hanger properly positioned in the housing, secure it in place by inserting the 3P-Tool and twisting it to the 'locked' position.
15. Using the 3P-Tool align the tubes of the two hangers.
16. Holding the meter horizontally, gently blow into it (DO NOT use compressed air). The rotor should turn freely. With a magnetic coil the rotor should gradually slow down and then "quiver" to a stop with one of its blades aligning with the pickup coil. With a MCP (RF) coil the rotor should "coast" smoothly to a stop.
17. Clean the flowmeter assembly with ISOPROPYL ALCOHOL or an alternately approved cleaning solution.

The flowmeter is ready for service. When installing the flowmeter be sure to orientate the in and out correctly.

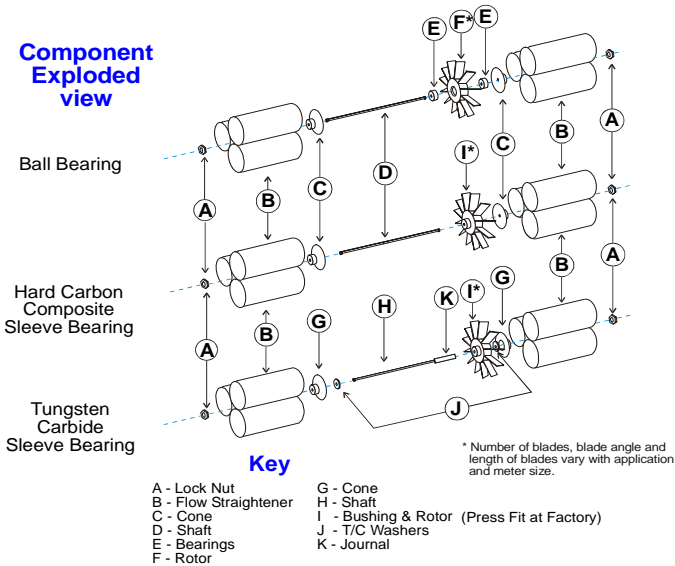

BEARING REPLACEMENT FOR WING NUT (WECO) METERS

For 1" and 1 1/2" meters (HO2x1 and HO2x1/1/2) follow bearing replacement procedure for threaded shafts on page 12.

For 2" and 3" meters (HO2x2 and HO3x3) a spiral retaining ring on the downstream (OUT) side of the meter must be removed first before removal of internals.

1. Using a long pic tool, locate the end of the spiral ring and pry it toward the center of the housing. Using a tool with a hooked end, pull the retainer out of the housing.
2. Follow bearing replacement procedure for threaded shafts on page 12.
3. After internals have been installed and checked, install new retainer ring.

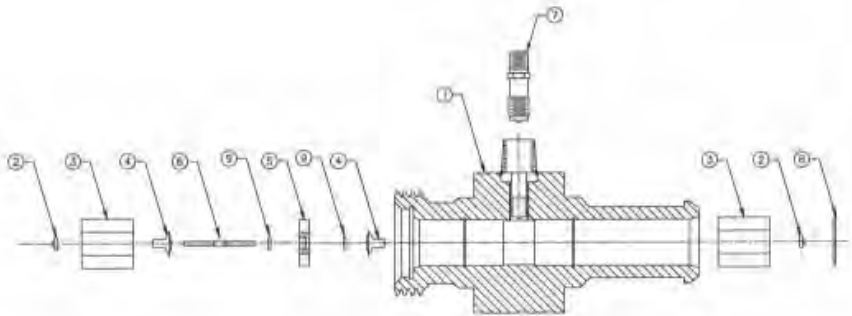

Wing Nut Meter with Ball Bearings (BB)

PARTS LIST	
1	HOUSING
2	LOCK NUT
3	HANGER ASSY
4	CONE
5	ROTOR
6	SHAFT
7	PICKUP COIL
8	RETAINING RING
9	BALL BEARINGS

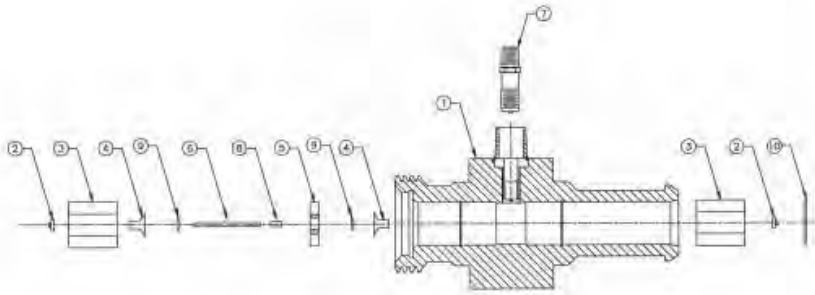

Wing Nut Meter with Tungsten Composite Sleeve Bearing (TC)

PARTS LIST	
1	HOUSING
2	LOCK NUT
3	HANGER ASSY
4	CONE
5	ROTOR
6	SHAFT
7	JOURNAL
8	THRUST WASHER
9	RETAINING RING

WEAR LIMITS FOR WING NUT (WECO) METERS

The Wing Nut style liquid and gas turbine flow meters are often used in abrasive fluids being pumped at high velocity. Under these conditions the meter body is subjected to accelerated wear and it should be inspected periodically. Hoffer specification allows an increased inside bore diameter up to 0.020". Refer to the table below for maximum allowable bore diameters.

Note the limitation on wear is not a pressure related limit, but is an assembly and meter performance related limit. If bore diameter increases by 0.020" there is no significant effect on pressure rating. However, internal hangers may start spinning causing further damage to the meter and meter K-factor may shift significantly causing a measuring error.

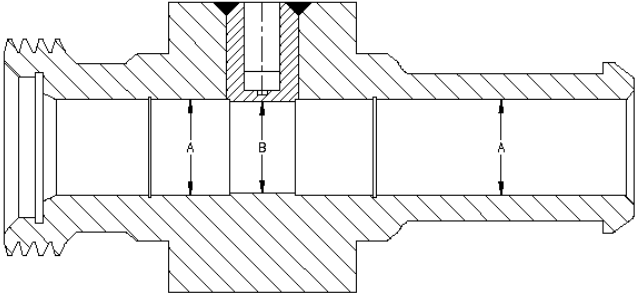

Refer to Hoffer Technical Note TN-55 for a full discussion on Wing Nut meter wear limits.

Maximum Allowable Bore Dimension:

<i>Meter size</i>	<i>A max</i>	<i>B max</i>
HO2X1	0.921"	0.897"
HO2X1 1/2	1.392"	1.334"
HO2X2	1.846"	1.773"
HO3X3	2.662"	2.601"

HO SERIES CALIBRATED SPARE OR REPLACEMENT INTERNAL KITS



MODEL - - - - - Internals

Flowmeter Size _____

Minimum Flow Range _____

Maximum Flow Range _____

Bearing Type

CB - Ceramic Hybrid self-lubricating ball bearings.

T - Tungsten Carbide

TFE - Teflon

C - Hard Carbon Composite

SPARE OR REPLACEMENT PICKUP COILS

<u>PART NO.</u>	<u>DESCRIPTION OF SERVICE</u>	<u>TEMPERATURE RATING</u>
MC3PAE	RF Coil ½" MNPT & 3" Leads	-250° to +400°F
MC3PA	RF Coil All HO Series	-250° to +400°F
PC13-110G	Cryogenic HO1 & Up	-450° to +450°F
PC13-74G	WECO HO 2X2 & HO 3X3 Liquid & Navy	-450° to +450°F
PC13-74S	HO Series HO1 & Up & Mini-Flows	-450° to +450°F
PC24-45G	HO1/4 thru HO3/4 Cryogenic, Trident & SY100	-450° to +450°F
PC24-45S	HO1/4 thru HO3/4 & HO1 & Larger Gas	-450° to +450°F
PC24-45EX	HO1/4 thru HO3/4 & HO1 & Larger Gas with ½" MNPT & 3" Leads	-450° to +450°F
PC28-13G	High Temp High Drag	-450° to +850°F
PC3-24G	Reluctance Center Mag for All Teflon	-35° to +120°F
PC24-92G	Hydrogen Vacuum Jacket	-450° to +450°F
PC28-14G	High Temp Low Drag	-450° to +850°F
PC3-24EX	Reluctance Teflon Series with ½" MNPT & 3" Leads	-35° to +120°F
MC2PAHT	High Temp RF with 3' Leads	-450° to +450°F
MC2PA	High Temp 2 Pin RF	-150° to +330°F
PC13-108G	Cryogenic 1" & Larger	-450° to +450°F
PC24-113G	WECO HO2X1 & HO2X11/2 Liquid & Gas	-450° to +450°F
PC13-74EX	Hi Drag with ½" MNPT & 3" Leads	-450° to +450°F
PC13-74S	Cryogenic 1" & Larger	-450° to +450°F
RF-4	WECO's All Sizes Requiring RF	-325° to +325°F
ISM-001	Intrinsic Mag Hi Drag 1" & Up & Mini-Flow Use	-97° to +207°F
PC24-123G	WECO HO2X2 & HO3X3 Gas	-450° to +450°F
ISM-003	Intrinsic Mag Low Drag ¾" & Smaller Use	-97° to +207°F
ISM-006	Intrinsic Reluctance For All Teflon Use	-35° to +120°F
PC28-38G	Hi Temp/Hi Drag For WECO HO2X11/2 & HO2X1	-450° to +850°F
PC3-33G	Reluctance Teflon Hi Output	-35° to +120°F
HE01S	Hall Effect Coil For HOG	-40° to +302°F
M-L3/8X1.52	Lo-Co Coil	-50° to +250°F
<u>REDI-PULSE PICKUP COILS:</u>		
RPMxxx	Redi-Pulse Mag Coil	-40° to +185°F
RPRxxx	Redi-Pulse RF Coil	-40° to +185°F
DMXxxx	Redi-Pulse Intrinsically Safe Mag Coil	-40° to +185°F
DRXxxx	Redi-Pulse Intrinsically Safe RF Coil	-40° to +185°F

NOTE: For the complete part number of the Redi-Pulse Pickup Coils or Intrinsically Safe Redi-Pulse Pickup Coils, Consult Factory.

RECOMMENDED SPARE AND REPLACEMENT PARTS

To assure maximum operating efficiency and minimum down time it is recommended that the following parts be stocked at all times.

<u>Part*</u>	<u>Nomenclature</u>	<u>Qty.</u>
Pickup Coil	Pickup Coil	1
Bearings	Ball Bearing type only	1 (set)
Rotor Assembly	Rotor with sleeve bearing	1
Complete Calibrated Internals Kit	Assembled & calibrated meter internals consisting of rotor, shaft, cones, bearings, and hangers.	1

NOTE : *Recommended spare parts lists should not be construed as an indication of possible failure, but reflect material available only from the manufacturer or his authorized representative. Quantity of recommended spares is based upon a single unit at any given location and provisioning may be adjusted accordingly in the event that multiple units comprise a system.*

* Contact the HFC Customer Service Department with the equipment model and serial number for the part numbers and current pricing for recommend spare parts.

STORAGE OF THE TURBINE FLOWMETER

The internal components of the turbine flowmeter are precision components which must be handled with care, and therefore, only qualified personnel should service the flowmeter.

Industrial Applications

When a turbine meter is removed from the process fluid to be placed in storage, the following preventative actions should be taken in order to prevent bearing failure:

For corrosive or non-lubricating fluids (excluding cryogenic and gas meters).

1. Clean all components with alcohol and allow to dry completely.
2. Coat all parts with machine oil.

For lubricating fluids.

1. Coat all parts with machine oil.

No abrasive material, such as emery paper or crocus cloth, should be used to clean any of the internal parts of the flowmeter.

After the flowmeter is properly cleaned and coated with oil, the end fittings should be covered with end caps so that no foreign material can enter the meter while in storage.

Cryogenic Application

In cryogenic applications, if the turbine flowmeter is removed from service and placed in storage, the meter must first be disassembled in a clean area. The area should be free from dust, oil, moisture, organic/inorganic particles, and any other pollutants which could contaminate the flowmeter components. Follow the procedures for bearing replacement as previously discussed.

Reassemble the flowmeter (after installing new bearings and replacing any worn parts). Next, the flowmeter should be immersed and thoroughly washed in an approved solvent. Take care to remove any oils or other contaminants present. At the conclusion of the solvent wash, allow the flowmeter to air dry.

The cleaned flowmeter should be placed in a plastic bag and electrically sealed for storage. The flowmeter is then tagged as "Cleaned for Cryogenic Service".

Sanitary Applications

When a sanitary turbine flowmeter is removed from service and placed in storage, the meter must first be cleaned by the recommended 3-A cleaning specifications. The flowmeter should then be allowed to thoroughly dry before storing. Once the meter is thoroughly dry, cap the end fittings so that no particles can enter the meter. Place the meter in a sealed plastic bag for storage.

When placing the sanitary meter back into service, remove the meter from the sealed bag and remove the protective caps. Clean the flowmeter as required by 3-A cleaning specifications before placing meter in service.

ADDENDUM

Installation of CSA Explosion-Proof Certified Product

Several Turbine flow meter product series have been certified by CSA for use in hazardous locations. These product lines are certified for use in the following hazardous locations:

Class I, Div 1, Groups ABCD; Class I, Div 2, Groups ABCD; Class II, Div 1, Groups EFG

Canada: Class I, Zone 1 and 2, Ex d IIC

USA: Class I, Zone 1 and 2, AEx d IIC

Certified Turbine Flow Meters model series HO consisting of the following product lines:

HO Custody Transfer Meters, model series HO-API-x in meter sizes 1", 1 ½", 2", 2 ½", 3" & 4" and HO-CT-100C-x in meter sizes 4", 6", 8", 10" & 12" in Stainless Steel or Carbon Steel meter bodies. Rated: -80°C to +180°C; Single Seal.

HO Grooved Meters, model series HO-GF-x in meter sizes 1", 1 ½", 2", 2 ½", 3", 4", 6", 8", 10" & 12" in Stainless Steel meter bodies.
Rated: -80°C to +180°C; Single Seal.

HO Gas Service Meters, model HO-G-x in meter sizes ¼", ⅜", ⅝", ¾", 1", 1 ¼", 1 ½", 2", 2 ½", 3", 4", 5", 6", 8", 10" & 12" in Stainless Steel or Carbon Steel meter bodies. Rated: -80°C to +180°C; Single Seal.

HO Liquid Service Meters, model HO-L-110I-x in meter sizes ¼", ⅜", ½", ⅝", ¾", 1", 1 ¼", 1 ½", 2", 2 ½", 3", 4", 5", 6", 8", 10" & 12" in Stainless Steel or Carbon Steel meter bodies. Rated: -80°C to +180°C; Single Seal.

HO Premium Gas Meters, model HO-PG-100B-x in meter sizes ¼", ⅜", ⅝", ¾", 1", 1 ¼", 1 ½", 2", 2 ½", 3", 4", 5", 6", 8", 10" & 12" in Stainless Steel or Carbon Steel meter bodies. Rated: -80°C to +180°C; Single Seal.

HO Industrial Star Meters, model HO-STAR-105F-x in meter sizes ¼", ½", ¾", 1", 1 ¼", 1 ½", 2", 2 ½" & 3" in Stainless Steel meter bodies. Rated: -80°C to +180°C; Single Seal.

HO Wafer Gas Service Meters, model HO-SWG-100E-x in meter sizes ⅝", ¾", 1", 1 ¼", 1 ½", 2", 2 ½" & 3" in Stainless Steel meter bodies. Rated: -80°C to +180°C; Single Seal.

HO Wafer Liquid Service Meters, model HO-SWL-100D-x in meter sizes ⅝", ¾", 1", 1 ¼", 1 ½", 2", 2 ½", 3", 4", 5", 6" & 8" in Stainless Steel meter bodies. Rated: -80°C to +180°C; Single Seal.

All of the above models may be optionally equipped with a "Limatherm" electrical enclosure, model XD-AD.

Notes:

1. The "x" represents numerous configuration options relating to rotor bearing size, pickup coils, end fittings; etc., which do not affect the electrical and mechanical safety rating of the product.
2. Meters can be equipment with 1 or 2 pickup coils.

Installation Instructions

1. Division 1 wiring methods must be used for Division 2 installations.
2. Zone 1 wiring methods must be used for Zone 2 installations.
3. For Class I, Group A installations using the optional "Limatherm" model XD-AD a conduit seal is required within 18" of the enclosure.

APPENDIX A

Hazard Analysis for Flow Meters and Installation Kits

Hoffer flow meters and installation kits are manufactured using PED compliant materials (if required) and are designed to operate under the specified applications and the temperature and pressure conditions.

Hazard Identification

The following hazards associated with operating Hoffer flow meters has been identified.

<i>Type of Hazard</i>	<i>Hazard Classification For Applications With Dangerous Fluids (Group 1)</i>	<i>Hazard Classification For Applications With Non-Dangerous Fluids (Group 2)</i>
Pipe/Meter Bursting	Dangerous Risk	Dangerous Risk
Flange Leaking	Dangerous Risk	Residual Risk
Skalds Risk	Residual Risk	Residual Risk

Risk Evaluation

Exceeding MAWP

The meters are design to withstand specified maximum allowable working pressure (MAWP) and temperature. The MAWP is listed on the meter drawing supplied with the meter. Under no circumstances shall fluid pressure exceed the MAWP. If the MAWP is exceeded, there is a dangerous risk of the meter or pipe bursting. In particularly, a meter could explode in pieces and flying metal debris could cause death or injury to the operator. In addition, there could be a burst of fluid contained in the meter. Fluids from Group 1 can cause fire, explosion, death or injury. Fluids from Group 2 can cause flooding, damage to the nearby equipment and short circuits in the electrical installations.

Flange Leaking

Hoffer flow meters should be installed according to the Hoffer Flow user manual. Proper fittings and washer should be used when applicable. Flanges should be tightened to the specified torque. In case of a leak from a flange or coupling, fluids from Group 1 can cause fire, explosion, death or injury. Fluids from Group 2 can cause flooding, damage to the nearby equipment and short circuits in the electrical installations.

Scalds Risk

There is a risk of skin scald in the applications where fluid operating temperatures are above 120 deg. F.

Vibration

Meters installed in vibrating pipes may develop weld defects and material cracks.

Corrosion

Meters shall be used only with corrosion compatible fluids.

Meter Internals Breakage

Meter internal parts may break when maximum allowable flow rate is exceeded.

Definition of Terms

Burst Pressure

Maximum pressure a pressure vessel can contain with out rupturing.

This is a calculated pressure using the Barlow's formula

$$(P = 2ST/D)$$

Where P = Burst pressure

S = Minimum material tensile strength at less than 40 deg. C

T = Minimum wall thickness

D = Outside diameter of vessel

Design Pressure

Maximum pressure above which the pressure vessel may sustain structural damage or fatigue. This is a calculated pressure using the Barlow's formula ($P = 2ST/D$)

When P = Maximum design pressure

S = Minimum material yield strength at less than 40 deg. C

T = Minimum wall thickness

D = Outside diameter of the vessel

Notes:

1. Design pressure can be de-rated for higher temperatures based on material yield strength at specified temperature.
2. Factors such as mechanical loads neither linear nor axial have been accounted for in these calculations.

Working Pressure

Pressure of the media contained in the system during normal operating conditions.

Maximum Allowable Working Pressure

The working pressure is recommended by Hoffer Flow Controls Inc.

The design pressure divided by a safety factor or a calculated pressure using Barrow's formula ($P = 2ST/D$).

When P = Maximum allowable working pressure
S = Minimum material stress at max temperature according to ASME B31.3

TABLE A-1

T = Minimum wall thickness

D = Outside diameter of pressure vessel

APPENDIX B

Pressure Equipment Directive (PED)

Marking and Labeling of PED flowmeters

Manufacturer name and address

Year of manufacture

Model number

Serial number

CE mark for Category I

CE0035 mark for Category II and III

Maximum temperature

Maximum pressure

Operating Instruction

Mounting and assembling, see pages 6-9 of this manual

Putting into service, see page 6 of this manual

Maintenance, see pages 11-17 of this manual

APPENDIX C
DRAWINGS

Related Drawings
For
Intrinsically Safe Pickup Coils

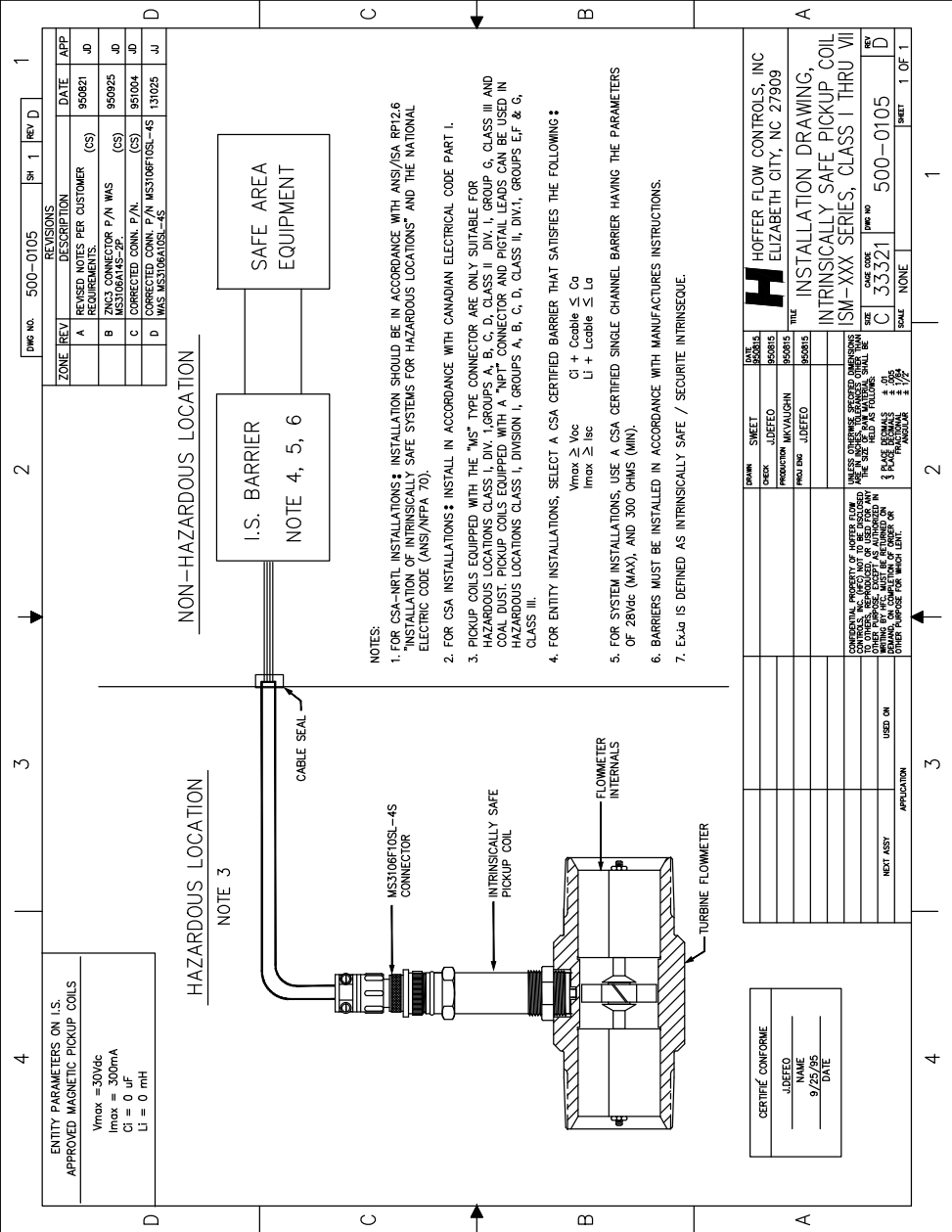

ZONE	REV	DESCRIPTION	DATE	APP
A	1	REVISED NOTES PER CUSTOMER REQUIREMENTS. (CS)	9/08/21	JD
B	2	ZNCG CONNECTOR P/N WAS MS3106F14S-2P.	9/09/25	JD
C	3	CORRECTED CONN. P/N.	9/10/04	JD
D	4	WAS MS3106F10S1-4S	1/31/025	JJ

NON-HAZARDOUS LOCATION

HAZARDOUS LOCATION

NOTE 3

I.S. BARRIER
NOTE 4, 5, 6

SAFE AREA
EQUIPMENT

- NOTES:
- FOR CSA-NRTL INSTALLATIONS, INSTALLATION SHOULD BE IN ACCORDANCE WITH ANSI/ISA RP12.6 INSTALLATION OF INTRINSICALLY SAFE SYSTEMS FOR HAZARDOUS LOCATIONS AND THE NATIONAL ELECTRIC CODE (ANSI/NFPA 70).
 - FOR CSA INSTALLATIONS, INSTALL IN ACCORDANCE WITH CANADIAN ELECTRICAL CODE PART 1.
 - PICKUP COILS EQUIPPED WITH THE "MS" TYPE CONNECTOR ARE ONLY SUITABLE FOR HAZARDOUS LOCATIONS CLASS I, DIVISION 1, GROUP C, CLASS II, DIVISION 1, GROUP C, CLASS III, AND COAL DUST PICKUP COILS EQUIPPED WITH "NPT" CONNECTOR AND PIGTAIL LEADS CAN BE USED IN HAZARDOUS LOCATIONS CLASS I, DIVISION 1, GROUPS A, B, C, D, CLASS II, DIV.1, GROUPS E,F & G, CLASS III.
 - FOR ENTRY INSTALLATIONS, SELECT A CSA CERTIFIED BARRIER THAT SATISFIES THE FOLLOWING :
 $V_{max} \geq V_{oc}$
 $I_{max} \geq I_{sc}$
 $C_i + C_{ocable} \leq C_o$
 $L_i + L_{ocable} \leq L_o$
 - FOR SYSTEM INSTALLATIONS, USE A CSA CERTIFIED SINGLE CHANNEL BARRIER HAVING THE PARAMETERS OF 28Vdc (MAX), AND 300 OHMS (MIN).
 - BARRIERS MUST BE INSTALLED IN ACCORDANCE WITH MANUFACTURES INSTRUCTIONS.
 - ExLq IS DEFINED AS INTRINSICALLY SAFE / SECURITE INTRINSEQUE.

ENTITY PARAMETERS ON I.S. APPROVED MAGNETIC PICKUP COILS

$V_{max} = 30Vdc$
 $I_{max} = 300mA$
 $C_i = 0 \mu F$
 $L_i = 0 mH$

CERTIFIÉ CONFORME

JURECO
 DATE
 9/25/05
 DATE

DRAWN	SHEET	DATE	ISSUED	REVISIONS
CHKD	JURECO			
PRODUCTION	MKVALUICHN			
FILED ENG	JURECO			

DATE	ISSUED	REVISIONS

COMPANY PROPERTY - NOT TO BE REPRODUCED OR COPIED WITHOUT THE WRITTEN PERMISSION OF HOFFER FLOW CONTROLS, INC.	
DATE REPRODUCED AS ISSUED	DATE
9/25/05	
DRAWING IS THE PROPERTY OF HOFFER FLOW CONTROLS, INC. AND IS NOT TO BE REPRODUCED OR COPIED FOR ANY OTHER PURPOSE FOR WHICH INTENT.	

DRIVER	HOFFER FLOW CONTROLS, INC
ADDRESS	ELIZABETH CITY, NC 27909
TITLE	INSTALLATION DRAWING, INTRINSICALLY SAFE PICKUP COIL ISM-XXX SERIES, CLASS I THRU VII
SIZE	CODE NO
	DWG NO
	C 33321
SCALE	NONE
	500-0105
REV	REV
1 OF 1	1 OF 1

DRAWING NO. 500-0106		SH 1	REV B
ZONE	REV	DESCRIPTION	DATE
A		ZNCS CONNECTOR P/N WAS MS3106A105-2P	950925
B		CORRECTED CONN. P/N MS3106F105-4S	131025
		WAS MS3106A105-4S	131025
			JJ

ENTY PARAMETERS ON I.S. APPROVED MAGNETIC PICKUP COILS
Vmax = 30Vdc
Imax = 300mA
CI = 0 uF
LI = 1.2 mH

HAZARDOUS LOCATION
NOTE 3

NON-HAZARDOUS LOCATION

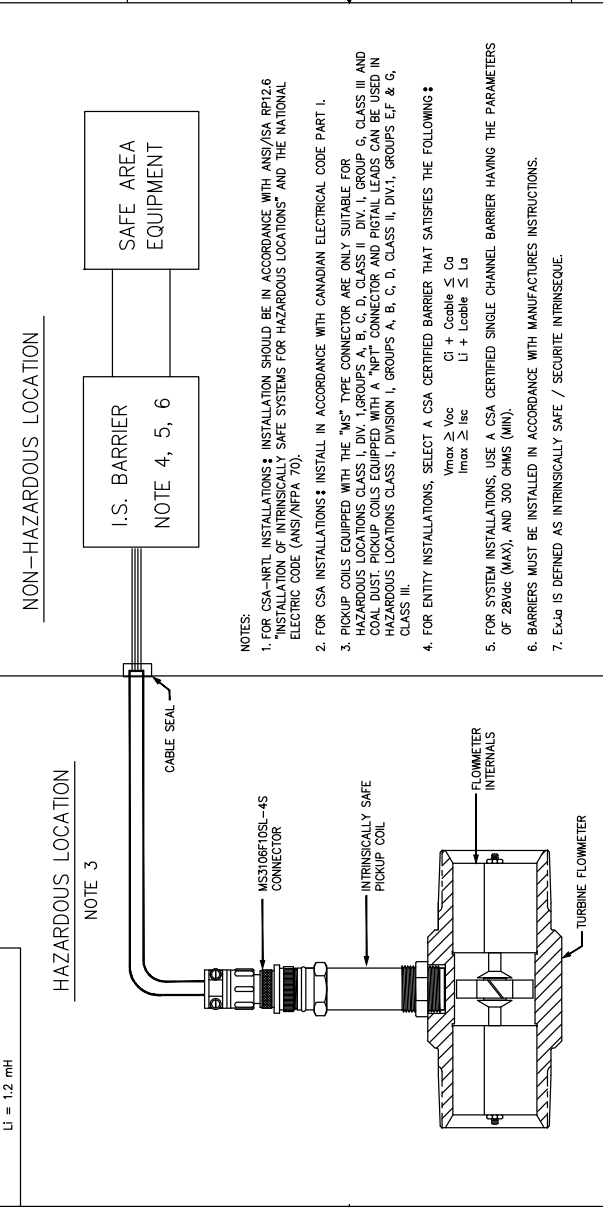

- NOTES:
- FOR CSA-NRTL INSTALLATIONS, INSTALLATION SHOULD BE IN ACCORDANCE WITH ANSI/ISA RP12.6 INSTALLATION OF INTRINSICALLY SAFE SYSTEMS FOR HAZARDOUS LOCATIONS AND THE NATIONAL ELECTRIC CODE (ANSI/NFPA 70).
 - FOR CSA INSTALLATIONS, INSTALL IN ACCORDANCE WITH CANADIAN ELECTRICAL CODE PART I.
 - PICKUP COILS EQUIPPED WITH THE "MS" TYPE CONNECTOR ARE ONLY SUITABLE FOR HAZARDOUS LOCATIONS CLASS I, DIVISION 1, GROUPS A, B, C, CLASS II, AND COAL DUST PICKUP COILS EQUIPPED WITH "NPT" CONNECTOR AND PIGTAIL LEADS CAN BE USED IN HAZARDOUS LOCATIONS CLASS I, DIVISION 1, GROUPS A, B, C, D, CLASS II, DIV.1, GROUPS E,F & G, CLASS III.
 - FOR ENTRY INSTALLATIONS, SELECT A CSA CERTIFIED BARRIER THAT SATISFIES THE FOLLOWING :
 $V_{max} \geq V_{oc}$ $C_i + C_{cable} \leq C_o$
 $I_{max} \geq I_{sc}$ $L_i + L_{cable} \leq L_o$
 - FOR SYSTEM INSTALLATIONS, USE A CSA CERTIFIED SINGLE CHANNEL BARRIER HAVING THE PARAMETERS OF 28Vdc (MAX), AND 300 OHMS (MIN).
 - BARRIERS MUST BE INSTALLED IN ACCORDANCE WITH MANUFACTURES INSTRUCTIONS.
 - EX4q IS DEFINED AS INTRINSICALLY SAFE / SECURITE INTRINSEQUE.

CERTIFIE CONFORME	DATE
9/25/95	

DATE	DESIGN	SHEET
950925	050622	050622
DESIGN	CHECK	JURFED
050622	050622	050622
DESIGN	PRODUCTION	M.C. VAUGHN
050622	050622	050622

SCALE	NONE
SCALE	1 OF 1

COMPANY	HOFFER FLOW CONTROLS, INC
ADDRESS	ELIZABETH CITY, NC 27909
TITLE	INSTALLATION DRAWING,
	INTRINSICALLY SAFE PICKUP COIL
	ISMC-XXX SERIES, CLASS VIII
SIZE	DWG NO
C 3321	500-0106
REV	REV
B	B

APPLICATION	USED ON
NET ASST	

RELATED DRAWINGS

ZONE REV	DESCRIPTION	DATE	APP
F	FOR REVISIONS A-E, SEE REV. E. DWG NO WAS 500-0157, REVISED TO SHOW NEW COMPLIANCE PER EOP. 335	9/10/01	

1 2 3 4

D C B A

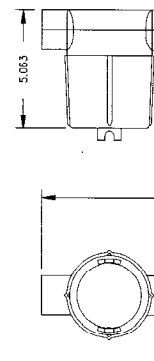

FRONT VIEW
X-PROOF VERSION
STYLE 3

SIDE VIEW

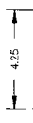

FRONT VIEW

X-PROOF VERSION
STYLE 4

SIDE VIEW OF 22B

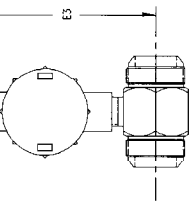

FRONT VIEW
X-PROOF VERSION
GUAC

SIDE VIEW

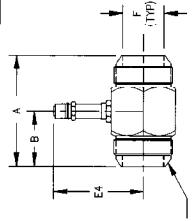

FRONT VIEW

X-PROOF VERSION
STANDARD

SIDE VIEW

NOTE:
SEE CHART 2
FOR DIMENSIONS.

CONTRACTOR		DATE	REVISIONS	
SKETCH	DWG	2-4-92	SH 1	REV F
CHECK	JD	2-4-92		
SCALE	1/16"	2-4-92		
PROJ ENG	KRH	2-4-92		

MATERIAL		DATE		REVISIONS	
FINISH		2-4-92		SH 1 REV F	

CONTRACTOR: HOFFER FLOW CONTROLS, INC. ELIZABETH CITY, NC 27909

INSTALLATION DRAWING, 1/2" - 3" LOWMETERS STD & X-PROOF VERSIONS MS33656 ENDS

REPLACES 500-0157

CASE CODE	DWG NO	REV
33.321	HOX-5001	F

SCALE NONE SHEET 1 OF 2

1 2 3 4

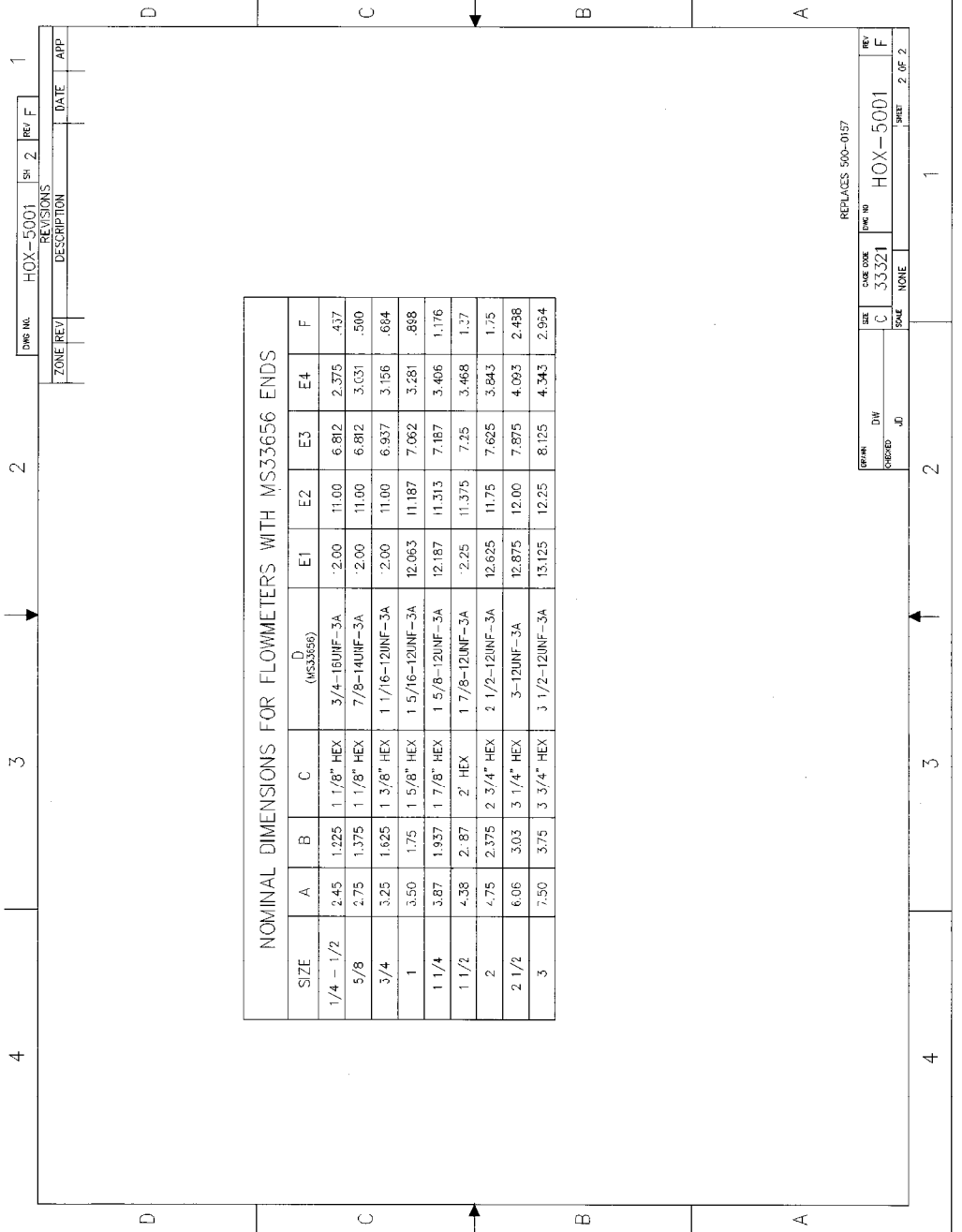

DWG NO.	HOX-5001	SH	2	REV	F
REVISIONS					
DESCRIPTION					
ZONE	REV	DATE	APP		

NOMINAL DIMENSIONS FOR FLOWMETERS WITH MS33656 ENDS

SIZE	A	B	C	D (MS33656)		E1	E2	E3	E4	F
1/4 - 1/2	2.45	1.225	1 1/8" HEX	3/4-16UNF-3A	-2.00	11.00	6.812	2.375	.437	
5/8	2.75	1.375	1 1/8" HEX	7/8-14UNF-3A	-2.00	11.00	6.812	3.031	.500	
3/4	3.25	1.625	1 3/8" HEX	1 1/16-12UNF-3A	-2.00	11.00	6.937	3.156	.684	
1	3.50	1.75	1 5/8" HEX	1 5/16-12UNF-3A		11.187	7.062	3.281	.888	
1 1/4	3.87	1.937	1 7/8" HEX	1 5/8-12UNF-3A	12.187	11.313	7.187	3.468	1.176	
1 1/2	4.38	2.87	2" HEX	1 7/8-12UNF-3A	-2.25	11.375	7.25	3.468	1.37	
2	4.75	2.375	2 3/4" HEX	2 1/2-12UNF-3A	12.625	11.75	7.625	3.843	1.75	
2 1/2	6.06	3.03	3 1/4" HEX	3-12UNF-3A	12.875	12.00	7.875	4.093	2.438	
3	7.50	3.75	3 3/4" HEX	3 1/2-12UNF-3A	13.125	12.25	8.125	4.343	2.954	

REPLACES 500-0157

DATE	3/3/21	DWG NO	HOX-5001	REV	F
SCALE	NONE	DATE		DATE	
DRWN	JD	CHKD	JD	DATE	2 OF 2

ZONE REV		DESCRIPTION		DATE		APP	
	A	REPAIR FOR MORE DETAIL		12-2-58			
	B	REVISED TO REFLECT 1/2" X-PROOF VERSION		4-2-58			
	C	REVISED TO REFLECT HEX MATERIAL		4-2-58			
	D	DRAWING NO. WAS HOX-5005		(OS)		505616	
	E	REVISED TO REFLECT X-PROOF VERSIONS, 971701					

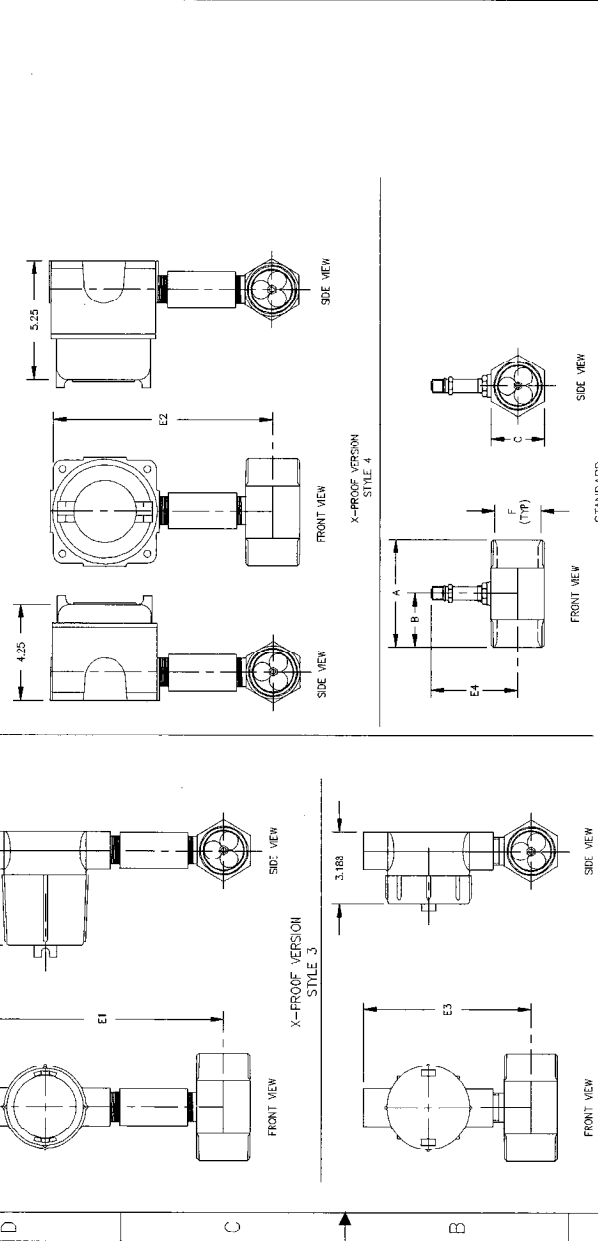

NOTE:
ALL SIZES UP TO AND INCLUDING 2" ARE BUILT WITH 4 HEX BODIES; 2-1/2" AND UP ARE BUILT WITH ROUND BODIES.

DRAWING NO.		REV		DATE		APP	
HOX-5005		5H 1		REV E			
DRAWING NO.		C 55321		HGX-5005		E	
SCALE		NONE		SHEET		1 OF 2	
<p>REPLACES 500-0159</p> <p>HOFFER FLOW CONTROLS, INC ELIZABETH CITY, NC 27809</p> <p>INSTALLATION DRAWING 1/2" - 4" FLOWMETERS STD & X-PROOF VERSIONS N.P.T. ENDS</p>							
<p>DATE 2-8-58 BY 2-8-58 CHECKED 2-8-58 APPROVED 2-6-58</p>				<p>MATERIAL</p> <p>FINISH</p> <p>PAINT</p> <p>WELD</p>			
<p>CONSTRUCTION</p> <p>PROJ. NO.</p> <p>ORIG.</p> <p>WELD SHOP</p>				<p>GENERAL INSTRUCTIONS: 1. ALL DIMENSIONS ARE TO UNLESS OTHERWISE SPECIFIED. 2. ALL DIMENSIONS ARE TO UNLESS OTHERWISE SPECIFIED. 3. ALL DIMENSIONS ARE TO UNLESS OTHERWISE SPECIFIED. 4. ALL DIMENSIONS ARE TO UNLESS OTHERWISE SPECIFIED. 5. ALL DIMENSIONS ARE TO UNLESS OTHERWISE SPECIFIED. 6. ALL DIMENSIONS ARE TO UNLESS OTHERWISE SPECIFIED. 7. ALL DIMENSIONS ARE TO UNLESS OTHERWISE SPECIFIED. 8. ALL DIMENSIONS ARE TO UNLESS OTHERWISE SPECIFIED.</p>			
<p>USE ON</p> <p>NEW ASSY</p>				<p>APPLICATION</p>			

Dwg No. HOX-5005 SH 2 REV E
 REVISIONS
 ZONE REVZ DESCRIPTION DATE APP

NOMINAL DIMENSIONS FOR FLOWMETERS WITH N. P. T. ENDS

SIZE	A	B	** C	D (N.P.T. TAPERED)	E1	E2	E3	E4	F
1/4 THRU 1/2	2.45	1.225	1.125	1/2 - 14	12.00	11.00	6.612	2.375	.622
5/8	2.75	1.375	1.125	3/4 - 14	12.00	11.00	6.612	3.031	.824
3/4	3.25	1.625	1.375	3/4 - 14	12.00	11.00	6.937	3.156	.824
1	3.50	1.75	1.625	1 - 11 1/2	12.063	11.187	7.082	3.281	1.049
1 1/4	3.875	1.937	1.875	1 1/4 - 11 1/2	12.187	11.313	7.187	3.406	1.36
1 1/2	4.375	2.187	1.875	1 1/2 - 11 1/2	12.25	11.375	7.25	3.466	1.610
2	4.75	2.375	2.750	2 - 11 1/2	12.625	11.75	7.625	3.843	2.067
2 1/2	6.062	3.031	2.882	2 1/2 - 8	12.875	12.00	7.875	4.093	2.567
3	7.50	3.75	3.50	3 - 8	13.00	12.125	8.000	4.216	3.066
4	10.00	5.00	4.75	4 - 8	12.625	12.75	8.75	4.966	4.062

REPLACES 500-0159

DRAWN DW
 CHECKED JD
 CASE CODE C 33321
 PART NO. HOX-5005
 SHEET 2 OF 2

NOTE:
SEE SHEET 2
FOR DIMENSIONS.

1
2
3
4

DWG NO.	HOX-5001	SK 1	REV F	DATE	APP
ZONE REV	F	DESCRIPTION			
FOR REVISIONS A-E, SEE REV. E.					
DWG NO WAS 500-0157, REVISED TO SHOW					
NEW COMPLIANCE PER EOP. 335					

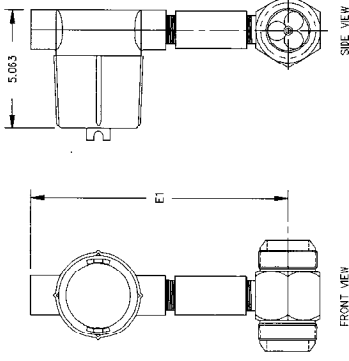

FRONT VIEW
X-PROOF VERSION
STYLE 3
SIDE VIEW

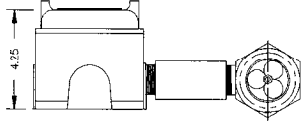

FRONT VIEW
X-PROOF VERSION
STYLE 4
SIDE VIEW

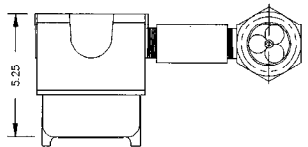

SIDE VIEW OF 22B

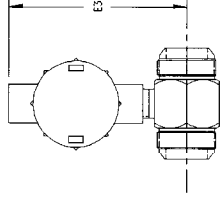

FRONT VIEW
X-PROOF VERSION
GUAC

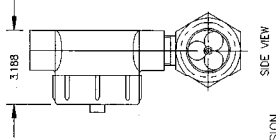

SIDE VIEW

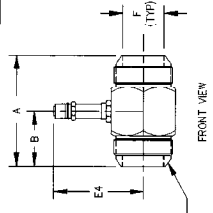

FRONT VIEW
STANDARD
SIDE VIEW

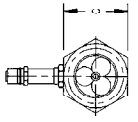

SIDE VIEW

REPLACES 500-0157

CONTRACTOR		DATE	REVISIONS		
MATERIAL	DRAWN	2-4-92	DESCRIPTION	DATE	APP
	CHECK	2-4-92	FOR REVISIONS A-E, SEE REV. E.	9/10/01	
	QA	2-4-92	DWG NO WAS 500-0157, REVISED TO SHOW		
	PROD ENG	2-4-92	NEW COMPLIANCE PER EOP. 335		
<p>CONSENTUAL AGREEMENT OF INTERFLOW... TO OTHERS, REPRODUCED OR USED FOR ANY PURPOSE WITHOUT THE WRITTEN PERMISSION OF HOFFER FLOW CONTROLS, INC. IS PROHIBITED. IF YOU ARE A CONTRACTOR, YOU SHALL BE RESPONSIBLE FOR OBTAINING ALL NECESSARY PERMITS AND APPROVALS FROM ALL AFFECTED AGENCIES AND AGENCIES OF THE STATE OF NORTH CAROLINA.</p>					
COMPANY	CASE CODE	DWG NO	REV	REV	
HOFFER FLOW CONTROLS, INC	MS33656	HOX-5001	F	F	
ELIZABETH CITY, NC 27909	SCALE	NONE	SHEET	1 OF 2	
INSTALLATION DRAWING,					
1/2" - 3" LOWMETERS					
STD & X-PROOF VERSIONS					

D C B A

4 3 2 1

SIZE	NOMINAL DIMENSIONS FOR FLOWMETERS WITH 150LB. FLANGES													
	A	B	C	D	E1	E2	E3	E4	F	G	H	DIA.	QTY.	
1/2	5.00	2.50	3.50	2.375	12.00	11.00	6.812	2.375	.822	1/2 - 150	.825	.825	4	
5/8	5.50	2.75	3.675	2.75	12.00	11.00	6.812	3.031	.824	3/4 - 150	.825	.825	4	
3/4	5.50	2.75	3.675	2.75	12.00	11.00	6.837	3.156	.824	3/4 - 150	.825	.825	4	
1	5.50	2.75	4.25	3.125	12.00	11.00	7.062	3.281	1.049	1 - 150	.825	.825	4	
1 1/4	6.00	3.00	4.625	3.50	12.20	11.33	7.187	3.406	1.18	1 1/4 - 150	.825	.825	4	
1 1/2	6.00	3.00	5.00	3.875	12.33	11.45	7.25	3.483	1.610	1 1/2 - 150	.825	.825	4	
2	8.50	3.25	6.00	4.75	12.56	11.68	7.625	3.943	2.067	2 - 150	.775	.775	4	
2 1/2	7.00	3.50	7.40	5.50	12.67	12.00	7.875	4.093	2.468	2 1/2 - 150	.775	.775	4	
3	10.00	5.00	7.50	6.00	13.13	12.25	8.000	4.218	3.088	3 - 150	.775	.775	4	
3 1/2	12.00	6.00	8.50	7.00	13.38	12.50	8.687	4.506	3.546	3 1/2 - 150	.775	.775	8	
4	12.00	6.00	9.00	7.50	13.63	12.75	8.75	4.668	4.062	4 - 150	.875	.875	8	
5	14.00	7.00	10.00	8.50	14.16	13.28	9.466	5.067	5.067	5 - 150	.875	.875	8	
6	14.00	7.00	11.00	9.50	14.69	13.80	9.937	5.196	6.065	6 - 150	.875	.875	8	
8	16.00	8.00	13.50	11.75	16.63	14.75	10.682	7.031	6.32	8 - 150	.875	.875	8	
10	20.00	10.00	16.00	14.25	16.75	15.88	11.675	8.063	10.062	10 - 150	1.00	1.00	12	
12	24.00	12.00	19.00	17.00	17.75	16.88	12.625	8.843	12.062	12 - 150	1.00	1.00	12	

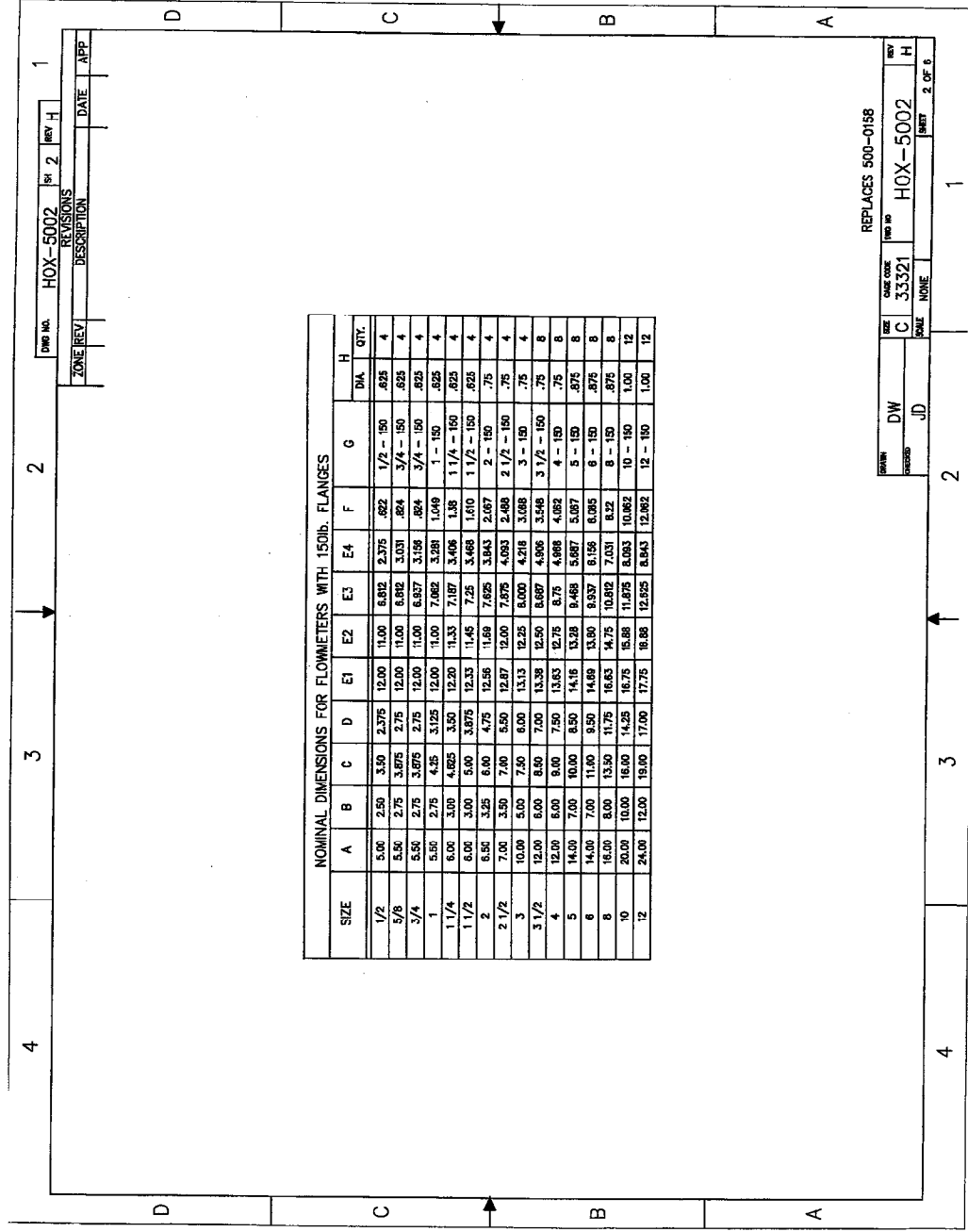

REPLACES 500-0158

DATE	REV.
DW	H
JD	H
DW	H
C	H
33321	H
HOX-5002	H
DRAWN	SCALE
33321	NONE
HOX-5002	2 OF 6

DWG NO.	HOX-5002	SH	3	REV	H
REVISIONS					
ZONE	REV	DESCRIPTION	DATE	APP	

1	2	3	4
---	---	---	---

4	3	2	1
---	---	---	---

D	C	B	A
---	---	---	---

NOMINAL DIMENSIONS FOR FLOWMETERS WITH 300lb. FLANGES

SIZE	H												DIA.	QTY.
	A	B	C	D	E1	E2	E3	E4	F	G				
1/2	5.00	2.50	3.75	2.8285	12.00	11.00	6.812	2.375	.622	1/2 - 300			.825	4
5/8	5.50	2.75	4.625	3.25	12.00	11.00	6.812	3.031	.824	3/4 - 300			.75	4
3/4	5.50	2.75	4.625	3.25	12.00	11.00	6.937	3.156	.824	3/4 - 300			.75	4
1	5.50	2.75	4.875	3.50	12.00	11.00	7.062	3.231	1.049	1 - 300			.75	4
1 1/4	6.00	3.00	5.25	3.875	12.20	11.33	7.187	3.406	1.38	1 1/4 - 300			.75	4
1 1/2	6.00	3.00	6.125	4.50	12.33	11.45	7.25	3.468	1.610	1 1/2 - 300			.875	4
2	6.50	3.25	6.50	5.00	12.56	11.69	7.625	3.643	2.067	2 - 300			.75	8
2 1/2	7.00	3.50	7.50	5.875	12.87	12.00	7.875	4.093	2.488	2 1/2 - 300			.875	8
3	10.00	5.00	8.25	6.625	13.13	12.25	8.000	4.218	3.068	3 - 300			.875	8
3 1/2	12.00	6.00	9.00	7.25	13.38	12.50	8.687	4.906	3.548	3 1/2 - 300			.875	8
4	12.00	6.00	10.00	7.875	13.63	12.75	8.75	4.968	4.062	4 - 300			.875	8
5	14.00	7.00	11.00	9.25	14.16	13.28	9.488	5.687	5.067	5 - 300			.875	8
6	14.00	7.00	12.50	10.625	14.69	13.80	9.937	6.156	6.065	6 - 300			.875	8
8	16.00	8.00	15.00	13.00	16.63	14.75	10.312	7.031	8.22	8 - 300			1.00	8
10	20.00	10.00	17.50	15.25	16.75	15.88	11.875	8.093	10.822	10 - 300			1.125	16
12	24.00	12.00	20.50	17.75	17.75	16.88	12.625	8.843	12.062	12 - 300			1.125	16

REPLACES 500-0158

FORM	DW	DATE	NO
REVISED	ID	C	33321
SCALE	NONE	HOX-5002	REV H
SHEET	3 OF 6		

1	2	3	4
---	---	---	---

1	2	3	4
DATE	REV H	REV G	REV F
APP	DESCRIPTION	DESCRIPTION	DESCRIPTION
REV	REV	REV	REV
DATE	DATE	DATE	DATE
REV	REV	REV	REV
DATE	DATE	DATE	DATE

NOMINAL DIMENSIONS FOR FLOWMETERS WITH 400 & 600lb. FLANGES

SIZE	A	B	C	D	E1	E2	E3	E4	F	G	H	
											DIA.	QTY.
1/2	5.00	2.50	3.75	2.6285	12.00	11.00	6.812	2.375	.822	1/2 - 400/600	.825	4
5/8	5.50	2.75	4.625	3.25	12.00	11.00	6.812	3.031	.824	3/4 - 400/600	.75	4
3/4	5.50	2.75	4.625	3.25	12.00	11.00	6.937	3.156	.824	3/4 - 400/600	.75	4
1	5.50	2.75	4.875	3.50	12.00	11.00	7.062	3.281	1.048	1 - 400/600	.75	4
1 1/4	6.00	3.00	5.25	3.875	12.20	11.33	7.187	3.408	1.38	1 1/4 - 400/600	.75	4
1 1/2	6.00	3.00	6.125	4.50	12.33	11.45	7.25	3.468	1.610	1 1/2 - 400/600	.875	4
2	6.50	3.25	6.50	5.00	12.56	11.69	7.625	3.843	2.067	2 - 400/600	.75	8
2 1/2	7.00	3.50	7.50	5.875	12.87	12.00	7.875	4.093	2.488	2 1/2 - 400/600	.875	8
3	10.00	5.00	8.25	6.625	13.13	12.25	8.000	4.218	3.068	3 - 400/600	.875	8
3 1/2	12.00	6.00	9.00	7.25	13.38	12.50	8.887	4.906	3.548	3 1/2 - 400/600	1.00	8
4	12.00	6.00	10.75	8.50	13.63	12.75	8.75	4.968	4.062	4 - 400/600	1.00	8
5	14.00	7.00	13.00	10.50	14.16	13.28	9.468	5.687	5.067	5 - 400/600	1.125	8
6	14.00	7.00	14.00	11.50	14.69	13.80	9.937	6.166	6.065	6 - 400/600	1.125	12
8	16.00	8.00	16.50	13.75	16.63	14.75	10.812	7.031	8.22	8 - 400/600	1.25	12
10	20.00	10.00	20.00	17.00	16.75	15.88	11.875	8.093	10.062	10 - 400/600	1.375	16
12	24.00	12.00	22.00	19.25	17.75	16.88	12.625	8.843	12.062	12 - 400/600	1.375	20

REPLACES 500-0168

FORM	GROUP	DW	J.D.
SIZE	CASE CODE	FORM NO	REV
C	33321	HOX-5002	H
DATE	MONTH	YEAR	SHEET
			4 OF 6

NOMINAL DIMENSIONS FOR FLOWMETERS WITH 900 & 1500lb. FLANGES

SIZE	A	B	C	D	E1	E2	E3	E4	F	G	H	
											DIA.	QTY.
1/2	7.00	3.50	4.75	3.25	12.00	11.00	6.812	2.375	.822	1/2 - 900/1500	.88	4
5/8	7.00	3.50	5.125	3.50	12.00	11.00	6.812	3.031	.824	3/4 - 900/1500	.88	4
3/4	7.00	3.50	5.125	3.50	12.00	11.00	6.937	3.156	.824	3/4 - 900/1500	.88	4
1	8.00	4.00	5.875	4.00	12.00	11.00	7.062	3.281	1.049	1 - 900/1500	1.00	4
1 1/4	8.00	4.00	6.25	4.375	12.20	11.33	7.187	3.406	1.38	1 1/4 - 900/1500	1.00	4
1 1/2	9.00	4.50	7.00	4.875	12.33	11.45	7.25	3.468	1.610	1 1/2 - 900/1500	1.12	4
2	9.00	4.50	8.50	6.50	12.56	11.69	7.625	3.843	2.067	2 - 900/1500	1.00	8
2 1/2	10.00	5.00	9.625	7.50	12.87	12.00	7.875	4.093	2.468	2 1/2 - 900/1500	1.12	8
3	10.00	5.00	9.50	7.50	13.13	12.25	8.000	4.218	3.068	3 - 900	1.00	8
3	10.00	5.00	10.50	8.00	13.13	12.25	8.000	4.218	3.068	3 - 1500	1.25	8
3 1/2	-	-	-	-	-	-	-	-	-	-	-	-
4	12.00	6.00	11.50	9.25	13.63	12.75	8.75	4.968	4.062	4 - 900	1.25	8
4	12.00	6.00	12.25	9.50	13.63	12.75	8.75	4.968	4.062	4 - 1500	1.38	8
5	14.00	7.00	13.75	11.00	14.16	13.28	9.468	5.887	5.087	5 - 900	1.38	8
5	14.00	7.00	14.75	11.50	14.16	13.28	9.468	5.887	5.087	5 - 1500	1.62	8
6	14.00	7.00	15.00	12.50	14.69	13.80	9.937	6.156	6.065	6 - 900	1.25	12
6	14.00	7.00	15.50	12.50	14.69	13.80	9.937	6.156	6.065	6 - 1500	1.50	12
6	16.00	8.00	18.50	15.50	16.63	14.75	10.812	7.031	8.22	8 - 900	1.50	12
6	16.00	8.00	19.00	15.50	16.63	14.75	10.812	7.031	8.22	8 - 1500	1.75	12
10	20.00	10.00	21.50	18.50	18.75	15.88	11.875	8.093	10.062	10 - 900	1.50	16
10	20.00	10.00	23.00	19.00	18.75	15.88	11.875	8.093	10.062	10 - 1500	2.00	12
12	24.00	12.00	24.00	21.00	17.75	16.88	12.625	8.843	12.062	12 - 900	1.50	20
12	24.00	12.00	26.50	22.50	17.75	16.88	12.625	8.843	12.062	12 - 1500	2.12	16

DWG NO. HOX-5002 Br 6 REV H
 REVISIONS
 ZONE REV DESCRIPTION DATE APP

NOMINAL DIMENSIONS FOR FLOWMETERS WITH 2500lb. FLANGES

SIZE	A	B	C	D	E1	E2	E3	E4	F	G	H	DIA.	QTY.
1/2	7.00	3.50	5.25	3.50	12.00	11.00	6.812	2.375	.822	1/2 - 2500		.875	4
5/8	7.00	3.50	5.50	3.75	12.00	11.00	6.812	3.031	.824	3/4 - 2500		.875	4
3/4	7.00	3.50	5.50	3.75	12.00	11.00	6.937	3.156	.824	3/4 - 2500		.875	4
1	8.00	4.00	6.25	4.25	12.00	11.00	7.062	3.281	1.049	1 - 2500		1.000	4
1 1/4	8.00	4.00	7.25	5.25	12.20	11.33	7.187	3.406	1.38	1 1/4 - 2500		1.125	4
1 1/2	9.00	4.50	8.00	5.75	12.33	11.45	7.25	3.468	1.610	1 1/2 - 2500		1.25	4
2	9.00	4.50	9.25	6.75	12.56	11.69	7.625	3.943	2.067	2 - 2500		1.125	8
2 1/2	10.00	5.00	10.50	7.75	12.87	12.00	7.875	4.093	2.488	2 1/2 - 2500		1.25	8
3	11.00	5.50	12.00	9.00	13.13	12.25	8.000	4.218	3.068	3 - 2500		1.375	8
3 1/2	--	--	--	--	--	--	--	--	--	--		--	--
4	12.00	6.00	14.00	10.75	13.63	12.75	8.75	4.968	4.062	4 - 2500		1.625	8
5	14.00	7.00	16.50	12.75	14.16	13.28	9.468	5.687	5.067	5 - 2500		1.875	8
6	16.00	8.00	19.00	14.50	14.69	13.80	9.937	6.156	6.065	6 - 2500		2.125	12
8	18.00	9.00	21.75	17.25	16.63	14.75	10.812	7.031	8.22	8 - 2500		2.125	12
10	22.00	11.00	26.50	21.25	16.75	15.88	11.875	8.093	10.062	10 - 2500		2.625	12
12	24.00	12.00	30.00	24.375	17.75	16.86	12.625	8.643	12.062	12 - 2500		2.875	12

REPLACES 500-0158

DWG NO. HOX-5002
 SIZE C 33321
 DW J0
 SCALE NONE
 SHEET 6 OF 6

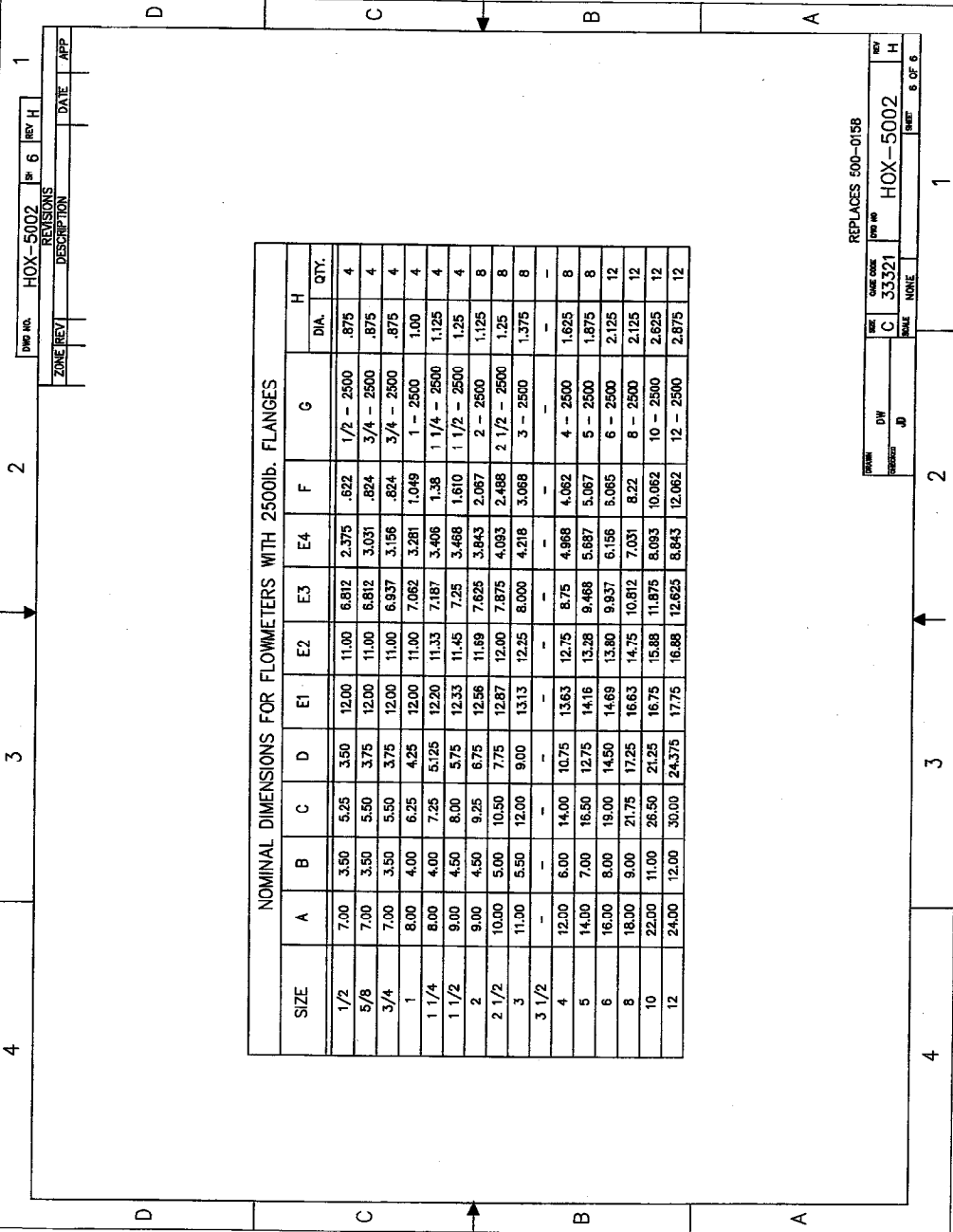

REV	DATE	BY	APP
2	08-08-78	PCX-901	TR
1	08-08-78	PCX-901	TR

2 PIN IS TYPE CONNECTOR MATES WITH MICRO-102-4S

2 PIN IS TYPE CONNECTOR MATES WITH MICRO-102-4S

2 PIN IS TYPE CONNECTOR MATES WITH MICRO-102-4S

2 PIN IS TYPE CONNECTOR MATES WITH MICRO-102-4S

2 PIN IS TYPE CONNECTOR MATES WITH MICRO-102-4S

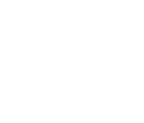
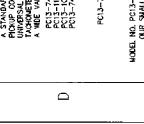
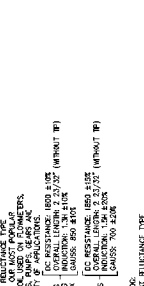
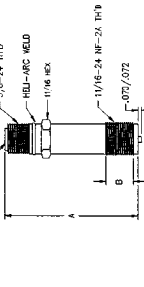
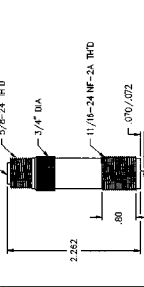

PICKUP COIL DIMENSIONS

MODEL NO.	DIMENSION 'A'	DIMENSION 'B'
P213-700	1.27/32"	.562
P213-740	2.23/32	.562
P224-450	2.97/32	.562
P213-1000	1.81/32	.562
P213-1086	2.69/32	.562
P213-1086	1.975	.562

PICKUP COIL DIMENSIONS

MODEL NO.	DIMENSION 'A'	DIMENSION 'B'
P213-700	1.27/32"	.562
P213-740	2.23/32	.562
P224-450	2.97/32	.562
P213-1000	1.81/32	.562
P213-1086	2.69/32	.562
P213-1086	1.975	.562

PICKUP COIL DIMENSIONS

MODEL NO.	DIMENSION 'A'	DIMENSION 'B'
P213-700	1.27/32"	.562
P213-740	2.23/32	.562
P224-450	2.97/32	.562
P213-1000	1.81/32	.562
P213-1086	2.69/32	.562
P213-1086	1.975	.562

PICKUP COIL DIMENSIONS

MODEL NO.	DIMENSION 'A'	DIMENSION 'B'
P213-700	1.27/32"	.562
P213-740	2.23/32	.562
P224-450	2.97/32	.562
P213-1000	1.81/32	.562
P213-1086	2.69/32	.562
P213-1086	1.975	.562

PICKUP COIL DIMENSIONS

MODEL NO.	DIMENSION 'A'	DIMENSION 'B'
P213-700	1.27/32"	.562
P213-740	2.23/32	.562
P224-450	2.97/32	.562
P213-1000	1.81/32	.562
P213-1086	2.69/32	.562
P213-1086	1.975	.562

PICKUP COIL DIMENSIONS

MODEL NO.	DIMENSION 'A'	DIMENSION 'B'
P213-700	1.27/32"	.562
P213-740	2.23/32	.562
P224-450	2.97/32	.562
P213-1000	1.81/32	.562
P213-1086	2.69/32	.562
P213-1086	1.975	.562

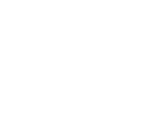
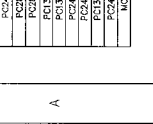
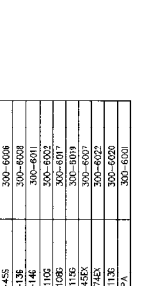
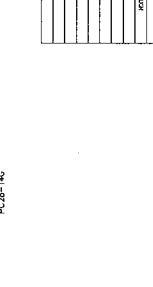
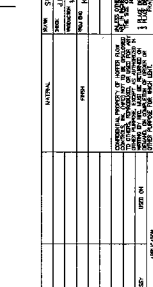
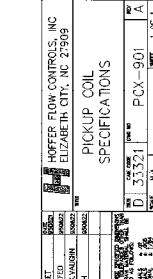
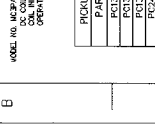
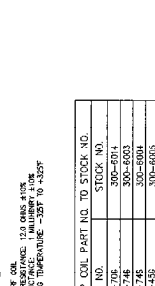
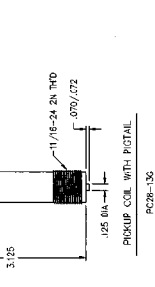
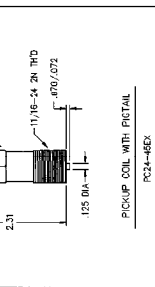
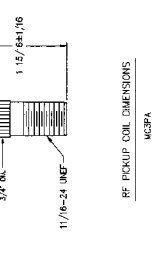
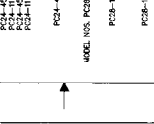
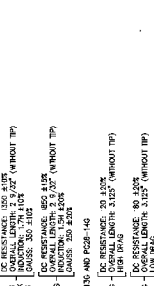
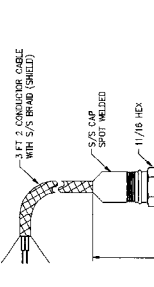
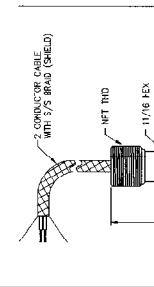
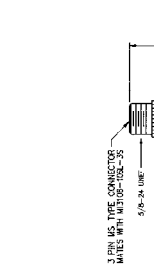

RF PICKUP COIL DIMENSIONS
MCPA

PICKUP COIL WITH PISTAL
PC24-45C

PICKUP COIL WITH PISTAL
PC24-14C
PC24-14C

PICKUP COIL WITH PISTAL
PC24-14C
PC24-14C

PICKUP COIL WITH PISTAL
PC24-14C
PC24-14C

PICKUP COIL WITH PISTAL
PC24-14C
PC24-14C

REV	DATE	BY	APP
1	08-08-78	PCX-901	TR
0	08-08-78	PCX-901	TR

HOFFER BLOW CONTROLS, INC
ELIZABETH CITY, NC 27808

PICKUP COIL SPECIFICATIONS

REV	DATE	BY	APP
1	08-08-78	PCX-901	TR
0	08-08-78	PCX-901	TR

HOFFER BLOW CONTROLS, INC
ELIZABETH CITY, NC 27808

PICKUP COIL SPECIFICATIONS

