

# **DIGI-HDMI-4X4**

**4 INPUT BY 4 OUTPUT MATRIX SWITCHER**





## Table of Contents

Overview.....	4
Installation .....	5
Operation .....	7
Troubleshooting and Frequently Asked Questions.....	20
Technical Specifications .....	26
Warranty .....	27
Contact Information.....	29

Copyright 2009 Intelix LLC.  
**DESIGN WITH INTELLIGENCE**  
Rev. 1003

## Important Safety Instructions

- **Please completely read and verify you understand all instructions in this manual before operating this equipment.**
- Keep these instructions in a safe, accessible place for future reference.
- Heed all warnings.
- Follow all instructions.
- Do not use this apparatus near water.
- Clean only with a dry cloth.
- Do not install near any heat sources such as radiators, heat registers, stoves, or other apparatus (including amplifiers) that produce heat.
- Use only accessories specified or recommended by Intelix.
- Explanation of graphical symbols:
  - Lightning bolt/flash symbol: the lightning bolt/flash and arrowhead within an equilateral triangle symbol is intended to alert the user to the presence of uninsulated “dangerous voltage” within the product enclosure which may be of sufficient magnitude to constitute a risk of shock to a person or persons. 
  - Exclamation point symbol: the exclamation point within an equilateral triangle symbol is intended to alert the user to the presence of important operating and maintenance (servicing) instructions in the literature accompanying the product. 
- **WARNING: TO REDUCE THE RISK OF FIRE OR ELECTRIC SHOCK, DO NOT EXPOSE THIS APPARATUS TO RAIN OR MOISTURE AND OBJECTS FILLED WITH LIQUIDS, SUCH AS VASES, SHOULD NOT BE PLACED ON THIS APPARATUS.**
- Use the mains plug to disconnect the apparatus from the mains.
- **THE MAINS PLUG OF THE POWER SUPPLY CORD MUST REMAIN READILY ACCESSIBLE.**
- Do not defeat the safety purpose polarized or grounding-type plug. A polarized plug has two blades with one wider than the other. A grounding-type plug has two blades and a third grounding prong. The wide blade or the third prong is provided for your safety. If the provided plug does not fit into your outlet, consult an electrician for replacement of your obsolete outlet. **Caution! To reduce the risk of electrical shock, grounding of the center pin of this plug must be maintained.**
- Protect the power cord from being walked on or pinched particularly at the plugs, convenience receptacles, and the point where they exit from the apparatus.
- Do not block the air ventilation openings. Only mount the equipment per Intelix’s instructions.
- Use only with the cart, stand, tripod, bracket, table, or rack specified by Intelix or sold with the equipment. When/if a cart is used, use caution when moving the cart/equipment combination to avoid injury from tip-over. 
- Unplug this apparatus during lightning storms or when unused for long periods of time.
- **Caution! Shock Hazard.** Do not open the unit. Refer to qualified service personnel. Servicing is required when the apparatus has been damaged in any way, such as power-supply cord or plug is damaged, liquid has been spilled or objects have fallen into the apparatus, the apparatus has been exposed to rain or moisture, does not operate normally, or has been dropped.
- Refer all servicing to qualified service personnel. Servicing is required when the apparatus has been damaged in any way, such as the power-supply cord or plug is damaged, liquid has been spilled or objects have fallen into the apparatus, the apparatus has been exposed to rain or moisture, does not operate normally, or has been dropped.

## Overview

The Intelix DIGI-HDMI-4X4 combines professional-grade performance with comprehensive control options, providing an easy-to-use, flexible, and powerful solution for high-definition audio/video distribution applications. A true matrix switcher, the DIGI-HDMI-4X4 features four HDMI inputs, four HDMI outputs and four twisted pair extender outputs. The matrix supports 1080i and 1080p high-definition video, and is HDMI 1.3b compliant. Switching is controlled via a diagnostic front panel interface or remotely via RS232, IR, or Ethernet.

In addition, the DIGI-HDMI-4X4 features four pass-through IR channels which distribute remote IR commands from in-room controllers, through compatible Intelix twisted pair extenders, up to 150 feet over twisted pair cable, and out of the matrix, allowing complete control of remote sources from the destination.

### **Design with Intelix and Design with Intelligence.**

#### *DIGI-HDMI-4X4 Package Contents*

- DIGI-HDMI-4X4 matrix switcher
- 5 VDC power supply
- 19" rack-mounting ears
- Remote control
- IR receiver
- Manual

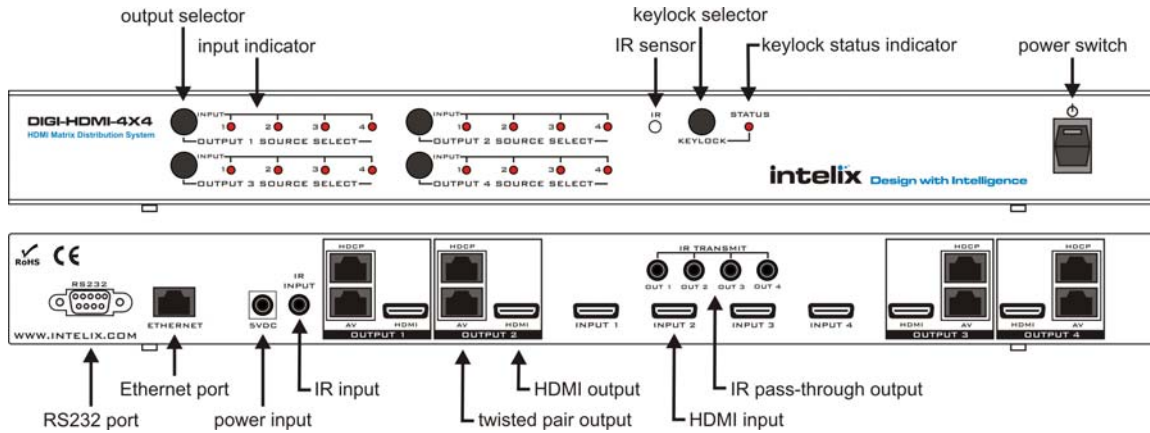

## Installation

To install the Intelix DIGI-HDMI-4X4 matrix switcher, please perform the following steps.

1. If mounting in a 19" audio/video rack, affix the 19" rack ears to the DIGI-HDMI-4X4. The DIGI-HDMI-4X4 requires 1 rack unit of spacing.

**Ventilation when Rack Mounting**

- At least 2 inches of free air space is required on both sides of the DIGI-HDMI-4X4 for proper side ventilation.
- Ensure there are no closeable doors on the rack that might seal the DIGI-HDMI-4X4 from a steady supply of cool air.
- Avoid mounting the DIGI-HDMI-4X4 near a power amplifier or any other source of significant heat.
- It is recommended that you leave an empty rack space above and below the DIGI-HDMI-4X4 for additional cooling.

2. Power-off the source and destination audio and video devices.

**Note:** All connecting audio-visual equipment must be powered off.

3. Connect the input sources to the DIGI-HDMI-4X4 using high-quality HDMI cables.
4. Connect the output destinations to the DIGI-HDMI-4X4 using high-quality HDMI cables.
5. For long distance destinations, connect two runs of twisted pair cable per run to the DIGI-HDMI-4X4 (twisted pair receivers sold separately).

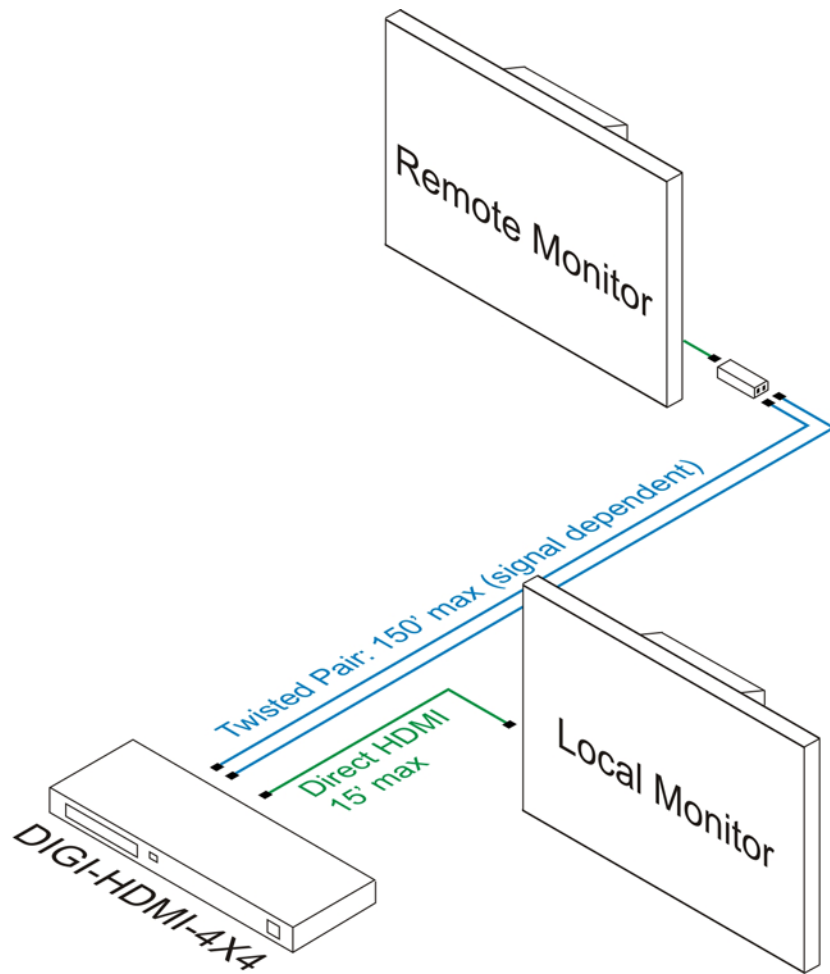

Product	1080i Max Distance	1080p Max Distance	IR
DIGI-HDMI-HR-R	150 feet	60 feet	No
DIGI-HDMI-IR-R	150 feet	100 feet	Yes

6. Connect the included 5 VDC power supply to the DIGI-HDMI-4X4.
7. If controlling remotely, connect RS232, Ethernet, or IR control cables.
8. Power-on the DIGI-HDMI-4X4.
9. Power-on the source and destination audio and video devices.

## Operation

To operate the Intelix DIGI-HDMI-4X4 matrix switcher, please perform the following steps.

**Note:** The DIGI-HDMI-4X4 features on-board memory. Settings are stored during power off and restored during power on.

### Front Panel Control

The DIGI-HDMI-4X4 features front panel control for switching inputs to the various outputs. Each output is represented by a push toggle button. Selecting the button toggles what input is being routed to the output.

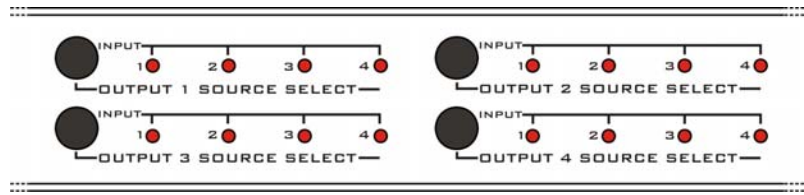

1. Determine if the DIGI-HDMI-4X4 front panel is locked. If the panel is locked, the keylock status indicator LED will be illuminated. If the panel is locked, unlock it by selecting the keylock selector button.
2. Determine which output you wish to change.
3. On the determined output, select the push toggle button. The input indicator will cycle through the inputs.
4. **Optional:** Once the desired input is selected, lock the front panel by selecting the keylock selector button.

**Note:** The DIGI-HDMI-4X4 front panel will automatically lock after one minute of inactivity.

### Included Remote Control

The DIGI-HDMI-4X4 includes a wireless remote control for switching inputs to the various outputs. Each output is represented by a bank of buttons on the remote control.

1. Determine which output you wish to change.
2. On the determined output, select the desired input number.
3. On the determined output, toggle through the inputs by selecting the *toggle input backward* or *toggle input forward* button.

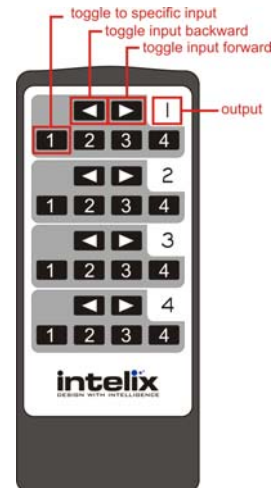

## IR Remote Control

The DIGI-HDMI-4X4 supports remote control through a front panel IR sensor and a rear panel 1/8" (3.5 mm) input jack.

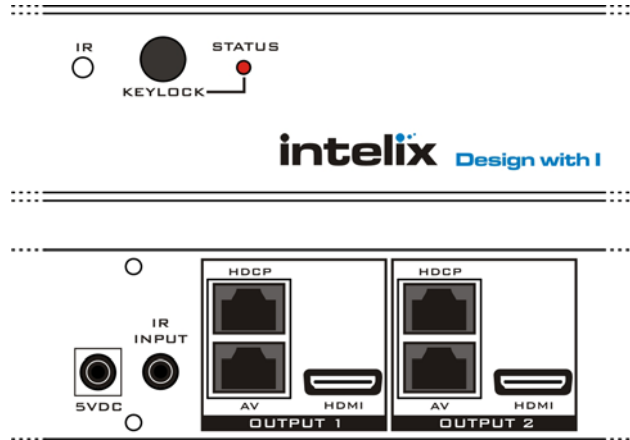

1. If controlling the DIGI-HDMI-4X4 through the 1/8" (3.5 mm) input jack on the rear panel, connect the IR cable directly to the matrix.

**Note:** Operation of the rear panel IR input will disable the front panel IR sensor.

2. If controlling the DIGI-HDMI-4X4 through the IR sensor on the front panel, place an IR emitter directly over the front panel sensor.

### *IR Emitter Mounting Tips*

- Surrounding electrical equipment may be producing high levels of IR noise. Plasma TVs and compact fluorescent lights are known polluters. Shield the outside of the emitter and the hardware's IR window with electrical tape.
- Verify the emitter is directly on the hardware's IR window and directly over the IR sensor. Operation may be intermittent if the emitter is too far away from the sensor.
- Clean the DIGI-HDMI-4X4 IR sensor window with an alcohol-based cleaner before applying the emitter to guarantee adhesion.
- Should the emitter not adhere to the DIGI-HDMI-4X4 sensor window, apply a small drop of glue to the adhesion pad on the emitter and re-apply.







Input 3 to Output 4	0000 006f 0000 0022 0151 00a7 0015 0015 0015 0015 0015 0015 0015 0015 0015 0015 0015 0015 0015 0015 0015 0015 003f 0015 003f 0015 003f 0015 003f 0015 003f 0015 003f 0015 003f 0015 003f 0015 003f 0015 003f 0015 003f 0015 0015 0015 0015 0015 0015 0015 0015 0015 0015 0015 0015 0015 0015 0015 0015 003f 0015 003f 0015 003f 0015 003f 0016 05d5
Input 4 to Output 4	0000 006f 0000 0022 0151 00a7 0015 0015 0015 0015 0015 0015 0015 0015 0015 0015 0015 0015 0015 0015 0015 0015 003f 0015 003f 0015 003f 0015 003f 0015 003f 0015 003f 0015 003f 0015 003f 0015 003f 0015 0015 0015 0015 0015 0015 003f 0015 0015 0015 003f 0015 0015 0015 0015 0015 003f 0015 003f 0015 003f 0015 0015 0015 003f 0015 0015 0015 003f 0016 05d5

### RS232 Remote Control

The DIGI-HDMI-4X4 supports remote control through a rear panel RS232 control port.

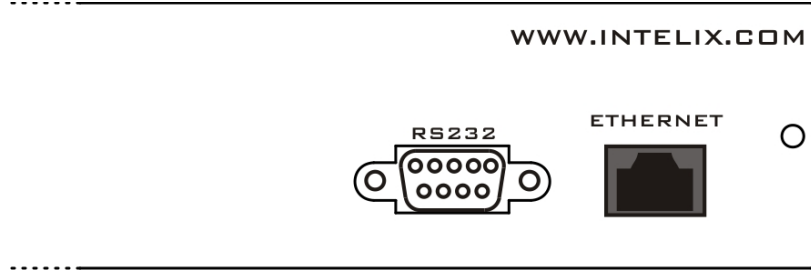

1. If controlling the DIGI-HDMI-4X4 through the RS232 control port on the rear panel, connect a straight-through serial cable directly to the matrix.

### DIGI-HDMI-4X4 RS232 Settings

Settings	
Bits per second	9600
Data bits	8
Parity	None
Stop bits	1
Flow control	Hardware

### DIGI-HDMI-4X4 RS232 Codes

Misc. Commands		
Function	Code	Return String
Get Device Type	br <space>	ASCII string containing the letter “a” followed by the name of the device
Get Device Status	bc <space>	ASCII string in the format of: “\r\n” + “s1Ys2Ys3Ys4Y” + “\r\n” where Y is the input source being routed to each output. The value of Y maps as follows: 0 = input 1 1 = input 2 2 = input 3 3 = input 4 The outputs channels map as follows: s1 = output 1 s2 = output 2 s3 = output 3 s4 = output 4
Output 1 Commands		
Function	Code	Return
Toggle Input 1	cir 09\r	The updated status for output

Toggle Input 2	cir 1D\r	1. Represented as an ASCII string in the format of “sXY” where: • X is a one based output channel • The value of Y maps as follows: 0 = input 1 1 = input 2 2 = input 3 3 = input 4
Toggle Input 3	cir 1F\r	
Toggle Input 4	cir 0D\r	
Toggle Input Forward	cir 41\r	
Toggle Input Backward	cir 57\r	
<b>Output 2 Commands</b>		
<b>Function</b>	<b>Code</b>	<b>Return</b>
Toggle Input 1	cir 17\r	The updated status for output 2. Represented as an ASCII string in the format of “sXY” where: • X is a one based output channel • The value of Y maps as follows: 0 = input 1 1 = input 2 2 = input 3 3 = input 4
Toggle Input 2	cir 12\r	
Toggle Input 3	cir 59\r	
Toggle Input 4	cir 08\r	
Toggle Input Forward	cir 11\r	
Toggle Input Backward	cir 1B\r	
<b>Output 3 Commands</b>		
<b>Function</b>	<b>Code</b>	<b>Return</b>
Toggle Input 1	cir 5E\r	The updated status for output 3. Represented as an ASCII string in the format of “sXY” where: • X is a one based output channel • The value of Y maps as follows: 0 = input 1 1 = input 2 2 = input 3 3 = input 4
Toggle Input 2	cir 06\r	
Toggle Input 3	cir 05\r	
Toggle Input 4	cir 03\r	
Toggle Input Forward	cir 48\r	
Toggle Input Backward	cir 55\r	
<b>Output 4 Commands</b>		
<b>Function</b>	<b>Code</b>	<b>Return</b>
Toggle Input 1	cir 18\r	The updated status for output 4. Represented as an ASCII string in the format of “sXY” where: • X is a one based output channel • The value of Y maps as follows: 0 = input 1 1 = input 2 2 = input 3 3 = input 4
Toggle Input 2	cir 44\r	
Toggle Input 3	cir 0F\r	
Toggle Input 4	cir 51\r	
Toggle Input Forward	cir 40\r	
Toggle Input Backward	cir 07\r	

\*Note: the space between “cir” and the code is required.

## Ethernet Remote Control

The DIGI-HDMI-4X4 supports remote control through a rear panel Ethernet control port. The matrix accepts control messages when integrated to a local area network (LAN).

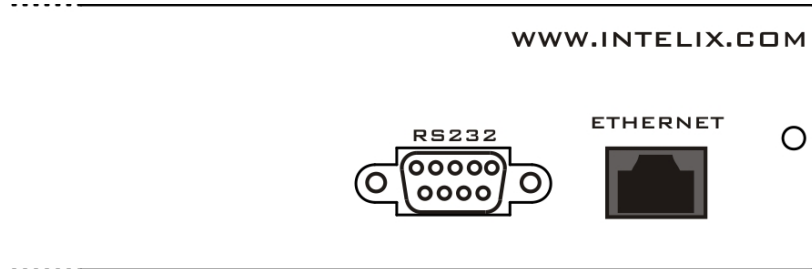

1. If controlling the DIGI-HDMI-4X4 through the Ethernet control port on the rear panel, connect an Ethernet cable directly to the matrix.

**Note:** The DIGI-HDMI-4X4 will automatically be assigned an IP address when connected to a DHCP-enabled network.

2. Connect the opposite end of the Ethernet cable to a LAN port. Within 10 seconds of connecting the DIGI-HDMI-4X4 to the LAN, the yellow LED on the matrix's Ethernet port will stop blinking and the green LED will blink intermittently.

**Connection Troubleshooting:** If the matrix does not respond with a green LED, please follow the steps below:

- Verify the LAN has DHCP support.
- Verify the LAN port is active.
- The LAN port on the DIGI-HDMI-4X4 requires the use of an Ethernet crossover cable if the hub or switch that you are connecting to does not support *Automatic MDI/MDI-X*.
- If you continue to have issues getting the matrix to connect to the LAN, verify LAN connectivity using a PC. If you can not get a PC to connect, contact a network administrator for assistance

## Controlling the Matrix over a LAN

Intelix provides a diagnostic software utility, *NetCtl*, to determine the IP address of the DIGI-HDMI-4X4 and to test Ethernet control functions. Please visit Intelix's online technical library to download the latest version of the software:

[http://www.intelix.com/tech\\_library/software.htm](http://www.intelix.com/tech_library/software.htm).

1. Download and install *NetCtl* on your computer.
2. Launch the utility. Two buttons appear.

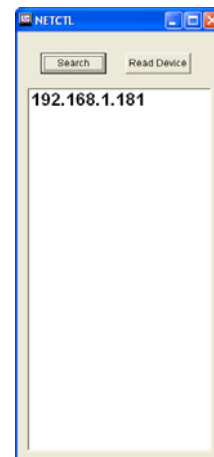

3. Click the *Search* button. This will search the LAN for all properly connected Intelix DIGI-HDMI series matrices. IP addresses for connected devices will be displayed.
4. Select the IP address of desired unit. Click the *Read Device* button. The IP address of the matrix will be replaced by the actual matrix name/model.
5. Double-click the matrix name/model. This will launch the control window.
6. In the control window, select the desired functions from the panel on the right side of the screen. The corresponding action will appear in the window on the left side.

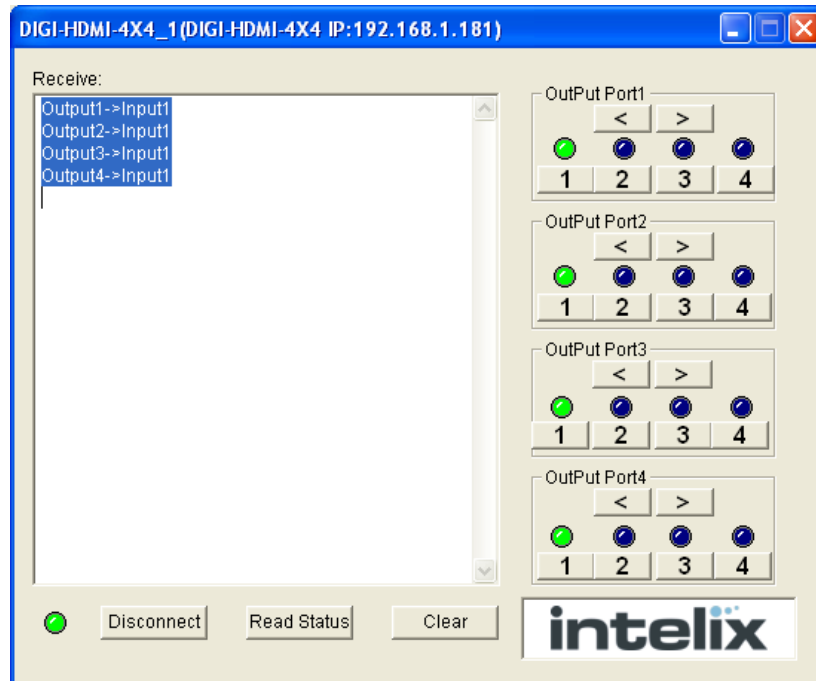
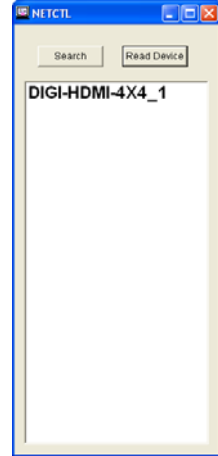

### DHCP Reservations

As a DHCP enabled device, the DIGI-HDMI-4X4 will automatically receive an IP address. However control systems require that devices have a *fixed* IP address on the network. You can configure a DHCP reservation in your DHCP server when you need to reserve a permanent IP address assignment for your matrix.

This section describes the steps necessary to assign a DHCP reservation. The intended audience is network administrators. If you are unable to complete this procedure, provide the information collected in steps 1-3 to your network administrator.

1. Verify that you are able to control your unit using the *NetCtl* utility as described above.

- Note the IP address that is assigned to the matrix. In the example above, the unit has an IP address of 192.168.1.181.
2. Quit the *NetCtl* utility
  3. Locate the directory where the *NetCtl* utility is located
    - Open the file *NetCtl.txt* using a Notepad or any text editor
    - You will see an entry that looks something like this:

00-0B-3C-05-56-83	DIGI-HDMI-4X4_1	DIGI-HDMI-4X4	192.168.1.181	255.255.255.0	192.168.1.198
-------------------	-----------------	---------------	---------------	---------------	---------------

- If you see multiple entries in the text file, use first entry in the list.
4. The first set of numbers in this example: 00-0B-3C-05-56-83 is the Media Access Control address (MAC address) of your unit. Please write this down.
  5. The fourth set of numbers in this example: 192.168.1.181 is the IP address assigned to your unit. Verify that this number matches the IP address that was displayed in the *NetCtl* utility in step #1.
  6. Provide the MAC address to your network administrator so she can reserve an IP address that will be given to your matrix and your matrix only.
    - The IP address that is reserved for your unit may be different from the original IP address assigned to your unit. This will not cause problems.

### Using 3<sup>rd</sup>-Party Software To Control the Matrix over a LAN

In addition to the *NetCtl* utility, you can also control the matrix using 3<sup>rd</sup>-party software from companies such as Crestron Electronics, Control4, Calypso Systems, etc.

1. Follow the steps defined in the *DHCP Reservations* section above to assign a fixed IP address to your unit.
2. Verify that you are able to control your unit using the *NetCtl* utility as described above.
3. See *DIGI-HDMI-4X4 Ethernet Codes* below for the commands
4. Communication settings:
  - The host address for Ethernet commands is the unit's fixed IP address
  - The port number is port 23



**DIGI-HDMI-4X4 Ethernet Codes**

<b>Misc. Commands</b>		
<b>Function</b>	<b>Code</b>	<b>Return String</b>
Get Device Type	Br	ASCII string containing the letter “a” followed by the device type
Get Device Status	Bc	ASCII string in the format of “\r\n” + “s1 Ys2Ys3Ys4Y” + “\r\n” where Y is the input source being routed to each output. The value of Y maps as follows: 0 = input 4 1 = input 3 2 = input 2 3 = input 1 The outputs channels map as follows: s1 = output 1 s2 = output 2 s3 = output 3 s4 = output 4
<b>Output 1 Commands</b>		
<b>Function</b>	<b>Code</b>	<b>Return</b>
Toggle Input 1	a09	The updated status for output 1. Represented as an ASCII string in the format of “sXY” where: • X is a one based output channel • The value of Y maps as follows: 0 = input 4 1 = input 3 2 = input 2 3 = input 1
Toggle Input 2	a1D	
Toggle Input 3	a1F	
Toggle Input 4	a0D	
Toggle Input Forward	a41	
Toggle Input Backward	a57	
<b>Output 2 Commands</b>		
<b>Function</b>	<b>Code</b>	<b>Return</b>
Toggle Input 1	a17	The updated status for output 1. Represented as an ASCII string in the format of “sXY” where: • X is a one based output channel • The value of Y maps as follows: 0 = input 4 1 = input 3 2 = input 2 3 = input 1
Toggle Input 2	a12	
Toggle Input 3	a59	
Toggle Input 4	a08	
Toggle Input Forward	a11	
Toggle Input Backward	a1B	
<b>Output 3 Commands</b>		
<b>Function</b>	<b>Code</b>	<b>Return</b>
Toggle Input 1	a5E	The updated status for output 1. Represented as an ASCII string in the format of “sXY” where:
Toggle Input 2	a06	
Toggle Input 3	a05	

Toggle Input 4	a03	<ul style="list-style-type: none"> <li>• X is a one based output channel</li> <li>• The value of Y maps as follows:                             <ul style="list-style-type: none"> <li>0 = input 4</li> <li>1 = input 3</li> <li>2 = input 2</li> <li>3 = input 1</li> </ul> </li> </ul>
Toggle Input Forward	a48	
Toggle Input Backward	a55	
<b>Output 4 Commands</b>		
<b>Function</b>	<b>Code</b>	<b>Return</b>
Toggle Input 1	a18	The updated status for output 1. Represented as an ASCII string in the format of “sXY” where: <ul style="list-style-type: none"> <li>• X is a one based output channel</li> <li>• The value of Y maps as follows:                             <ul style="list-style-type: none"> <li>0 = input 4</li> <li>1 = input 3</li> <li>2 = input 2</li> <li>3 = input 1</li> </ul> </li> </ul>
Toggle Input 2	a44	
Toggle Input 3	a0F	
Toggle Input 4	a51	
Toggle Input Forward	a40	
Toggle Input Backward	a07	

### IR Twisted Pair Pass-Through

When used with compatible Intelix receivers (DIGI-HDMI-IR-R), the DIGI-HDMI-4X4 supports four pass-through IR channels which distribute remote IR commands from in-room controllers, up to 150 feet over twisted pair cable, and out of the matrix.

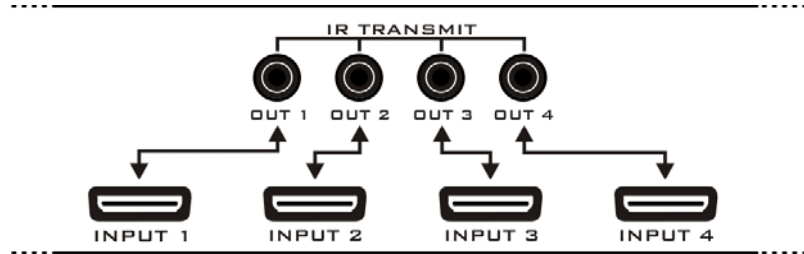

1. Determine which devices you wish to control via the IR pass-through outputs.

**Note:** By default, IR transmit output one corresponds to HDMI input one, IR transmit output two corresponds to HDMI input two, IR transmit output three corresponds to HDMI input three, and IR transmit output four corresponds to HDMI input four. Therefore, the IR output port will control the source connected to the HDMI input.

2. Connect an IR cable to the desired IR transmit output port.
3. Repeat for up to four devices.

**Note:** Optionally, IR commands for the matrix may be transmitted from a remote receive balun. For successful operation, the output of the IR transmit output port must be routed to the 1/8" (3.5 mm) IR rear panel connector or the front panel IR sensor.

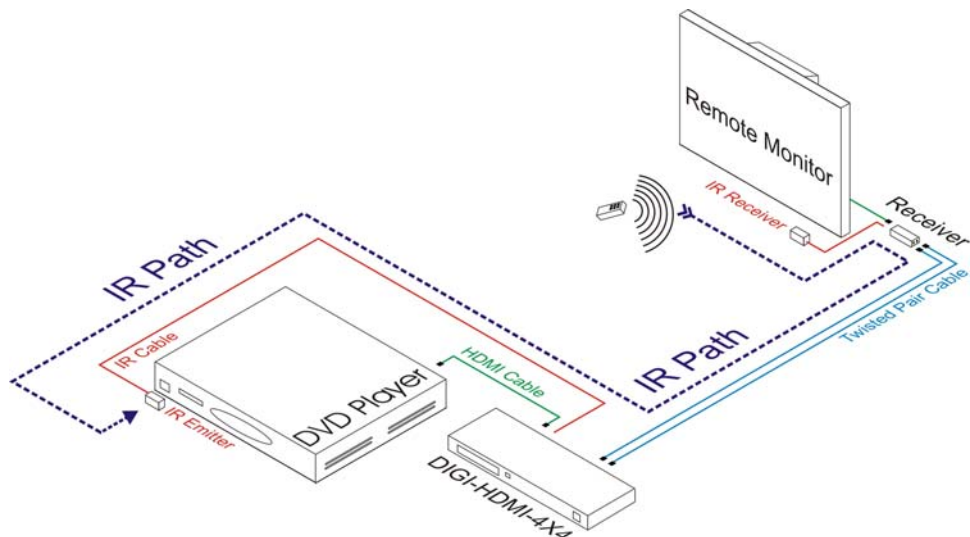

4. All of the remote receive baluns transmit IR commands from the included remote control, thereby allowing remote control of the matrix itself.

**Note:** If the IR codes for a pass-through signal conflict with the internal IR codes of the matrix, the processing of remote matrix IR commands may be disabled.

Simultaneously press and hold the *Output 2 Source Select* and *Keylock* buttons for three seconds. A single flash of the front panel source select LEDs indicates the remote IR commands are enabled. A double flash of the front panel source select LEDs indicates the remote IR commands are disabled.

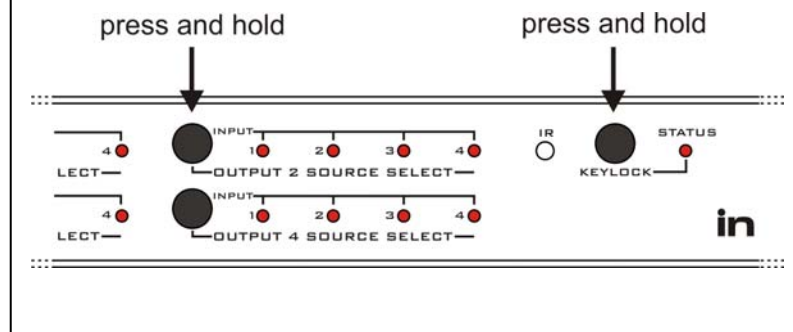

## Troubleshooting & Frequently Asked Questions

### What is the factory default HDMI mode for this device?

As shipped from the factory, this device is configured to output HDMI 1.2 signals at 1080p to all outputs.

### When to I need to change the factory default HDMI mode?

If you have both an HDMI 1.3 compatible source (Blu-ray® player, Sony Playstation 3®, etc.) as well as an HDMI 1.3 television capable of Deep Color support, you will need to change the HDMI mode of the device to support the newer HDMI 1.3 feature.

### How do I switch the device to HDMI 1.3 mode?

To switch the matrix to HDMI 1.3 mode, please perform the following steps:

1. Power on the DIGI-HDMI-4X4 matrix.
2. Disconnect the input sources from the DIGI-HDMI-4X2.
3. Connect the output destinations to the DIGI-HDMI-4X4 using high-quality HDMI cables. Disconnect any twisted pair extenders.

**Note:** In order to switch to HDMI 1.3 mode, destinations must be connected to the matrix with HDMI cables. The matrix will not toggle HDMI 1.3 mode when twisted pair extenders are connected.

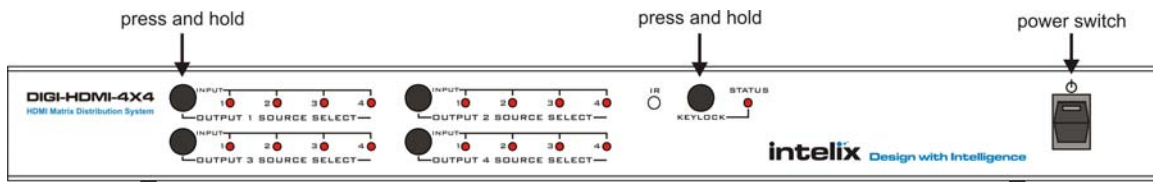

4. Simultaneously press and hold the *Output 1 Source Select* and *Keylock* buttons for five seconds. The front panel source select LEDs will illuminate and flash during mode transition.
5. After the LEDs cease flashing, release the *Output 1 Source Select* and *Keylock* buttons. The DIGI-HDMI-4X4 is now in HDMI 1.3 mode.

**Note:** The DIGI-HDMI-4X4 features on-board memory. Settings are stored during power off and restored during power on.

### How do I switch the device to HDMI 1.2 (factory default) mode?

To switch the matrix to HDMI 1.2 (factory default) mode, please perform the following steps:

1. Power on the DIGI-HDMI-4X4 matrix.
2. Disconnect the input sources from the DIGI-HDMI-4X4.
3. Disconnect the output destinations to the DIGI-HDMI-4X4. Disconnect any twisted pair extenders.

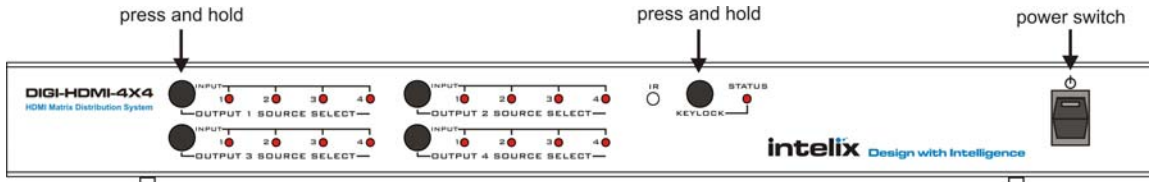

4. Simultaneously press and hold the *Output 1 Source Select* and *Keylock* buttons for five seconds. The front panel source select LEDs will illuminate and flash during mode transition.
5. After the LEDs cease flashing, release the *Output 1 Source Select* and *Keylock* buttons. The DIGI-HDMI-4X4 is now in HDMI 1.2 (factory default) mode.

**Note:** The DIGI-HDMI-4X4 features on-board memory. Settings are stored during power off and restored during power on.

### Does the matrix support both HDMI 1.2 and HDMI 1.3 mode simultaneously?

The DIGI-HDMI-4X4 does not support HDMI 1.2 and HDMI 1.3 mode simultaneously. The matrix must be toggled for one or the other.

### My destination is capable of Dolby TrueHD® but it's not receiving an HD signal from the Blu-ray® player.

The DIGI-HDMI-4X4 may not be set in HDMI 1.3 (Dolby TrueHD®) compatible mode. Switch the matrix to HDMI 1.3 mode by following the steps on page 11.

**Note:** Not all Blu-ray® discs are mastered with Dolby TrueHD® audio. Please verify your movie is encoded with this format.

**My destination supports a resolution other than 1080p, but it's receiving a 1080p signal.**

The DIGI-HDMI-4X4 supports device learning; i.e., the matrix can query connected sources and destinations and learn and store their individual resolutions.

1. Verify the desired destination is connected to the DIGI-HDMI-4X4 matrix.
2. Disconnect the input sources from the DIGI-HDMI-4X4.
3. Route the signal from the desired source to the desired destination.
4. Disconnect all other sources and destinations from the matrix.

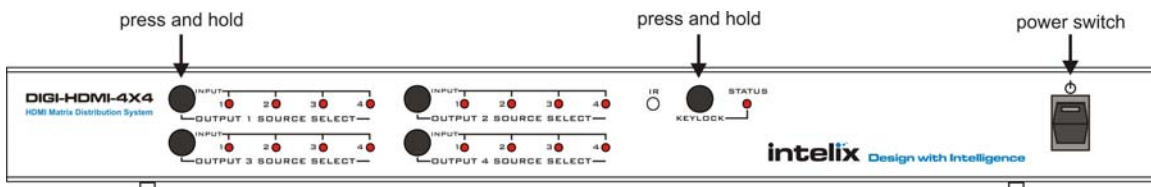

5. Simultaneously press and hold the *Output 1 Source Select* and *Keylock* buttons for five seconds. The front panel source select LEDs will illuminate and flash during mode transition.
6. After the LEDs cease flashing, release the *Output 1 Source Select* and *Keylock* buttons. The DIGI-HDMI-4X4 has now learned and stored your devices' settings.

**Note:** The DIGI-HDMI-4X4 features on-board memory. Settings are stored during power off and restored during power on.

**How can I tell if my matrix is connected to the network?**

The matrix is controllable via IP; however, the unit must be properly connected to the network.

- If you see a solid amber LED with a blinking green LED, the unit is correctly connected to the network.
- If you see a blinking amber LED and no green LED, the unit is not communicating with the network.

**My Ethernet port is not physically connecting to the network.**

There are several external reasons why the matrix might not be connecting to the network.

1. Try a different Ethernet cable to verify the cable is operational.

2. Try connecting a computer to the network port to verify the port is active/operational.
3. Try using an Ethernet crossover cable.

### What is the IP address of my matrix?

Run the *Intelix DIGI-HDMI* software from the *Intelix Installation CD* or from the Intelix website. Once connected, the IP address of your unit will be displayed in the title bar of the application.

**Note:** The Ping utility on a PC will verify that your matrix is accessible on the network.

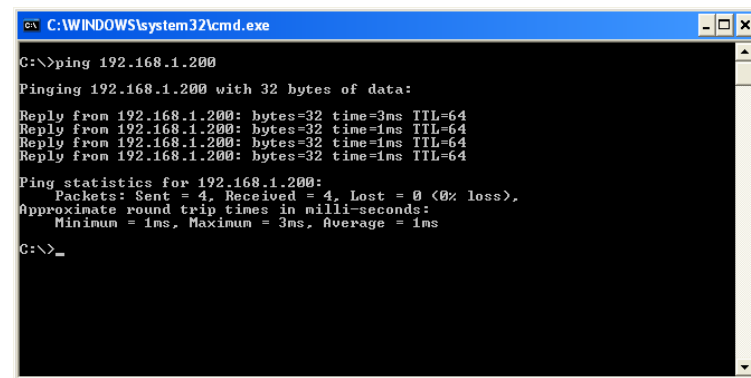

```
C:\WINDOWS\system32\cmd.exe
C:\>ping 192.168.1.200
Pinging 192.168.1.200 with 32 bytes of data:
Reply from 192.168.1.200: bytes=32 time=3ms TTL=64
Reply from 192.168.1.200: bytes=32 time=1ms TTL=64
Reply from 192.168.1.200: bytes=32 time=1ms TTL=64
Reply from 192.168.1.200: bytes=32 time=1ms TTL=64
Ping statistics for 192.168.1.200:
    Packets: Sent = 4, Received = 4, Lost = 0 (0% loss),
    Approximate round trip times in milli-seconds:
        Minimum = 1ms, Maximum = 3ms, Average = 1ms
C:\>_
```

### How do I assign a static IP address to my matrix?

We recommend that permanent IP addresses be assigned using DHCP reservation rather than a static IP assignment. Before you can reserve an IP address, you need the MAC address of your matrix.

### What is the MAC address of my matrix?

1. Run the *Intelix DIGI-HDMI* software from the *Intelix Installation CD* or from the Intelix website.
2. After successfully connecting to your unit, open the *NetCtl.txt* text file which is located in the same directory as the *DIGI-HDMI* software (*NetCtl.exe*). This file will open with your PC's *Notepad* application (*Notepad.exe*).
3. The first 17 characters in the file is the MAC address of your unit; e.g. 00-0B-3C-05-54-8C. Record this MAC address, it will be useful when reserving a fixed IP address for your matrix.



**New Reservation** ? X

Provide information for a reserved client.

Reservation name: DIGI-HDMI-4x4

IP address: 192.168.1.200

MAC address: 00-0B-3C-05-54-8C

Description: Network controllable HDMI matrix

Supported types

Both

DHCP only

BOOTP only

Add Close

**Note:** If your system supports a *Name* and *Description* field in the DHCP reservation, Intelix recommends that you fill these fields with a descriptive name that will allow the network administrator to easily and quickly identify the unit.

4. After you reserve an IP address for your matrix, you will need to power cycle the unit. This will obtain the new, reserved IP address.

**Note:** To verify the matrix is using the desired IP address, Intelix recommends Pinging the unit (see above).

## Technical Specifications

Vertical Frequency Range .....	24 - 60 Hz
Output Video .....	HDMI 1.2/HDMI 1.3
Signaling Rate .....	2.25 gigabits per second
Input DDC Signal .....	5.0 volts p-p (TTL)
Input Video Signal.....	0.5 – 1.0 volts p-p
Video Amplifier Bandwidth .....	255 MHz
Input Connectors .....	Four (4) HDMI type A connectors
Output Connectors.....	Four (4) HDMI type A connectors with locking screws Four (4) dual twisted pair connectors
Supported Video Resolutions .....	480i, 480p, 576i, 576p, 720p, 1080i, 1080p 8, 10, 12 bits per channel
Supported Audio.....	Dolby TrueHD 7.1, Dolby TrueHD 5.1, Dolby Digital 5.1 DTS-HD Master Audio 7.1, DTS-HD Master Audio 5.1, DTS 5.1, PCM 2.0, PCM 5.1
Diagnostic.....	Front panel input to output LEDs Front panel keylock LED
Operating Temperature Range.....	-41 to 95 degrees F -5 to 35 degrees C
Operating Humidity Range.....	5 to 90% non-condensing
Included Accessories .....	One (1) 5 VDC power supply Two (2) 19” rack mounting ears One (1) remote control
Control.....	Front panel channel, RS232, IR and Ethernet
Dimensions .....	17.375” x 8.375” x 1.625” 1 RU
Enclosure .....	Black metal
Max Power Consumption .....	11 watts
Power .....	5 VDC
Regulatory .....	CE, RoHS
Compatible Intelix Twisted Pair Receivers .....	DIGI-HDMI-HR-R DIGI-HDMI-IR-R
Shipping Weight.....	7.1 lbs
Intelix Part Number .....	DIGI-HDMI-4X4
Warranty .....	2 years



## Warranty

Intelix warrants to the original purchaser of new and B-stock products that the product will be free from defects in material and workmanship for a period of 2 years from the date of purchase from an authorized Intelix reseller, subject to the terms and conditions set forth below.

All Intelix products are guaranteed against malfunction due to defects in materials or workmanship for two years after date of purchase. If a malfunction does occur during the specified period, the defective product will be repaired or replaced at Intelix's option without charge. As a condition to receiving the benefits of this warranty, you must provide Intelix with documentation that establishes you were the original purchaser of the Intelix products. If you are not the original purchaser, the Intelix equipment must be returned to the original purchaser or another authorized Intelix reseller accompanied by dated documentation of proof of purchase. Please contact Intelix for a list of authorized resellers.

This warranty does not cover: 1) Malfunction resulting from use of the product other than as specified in the user manual; 2) Installation specific wiring; 3) Malfunction resulting from abuse or misuse of the product; 4) Exterior chassis appearance; 5) Malfunction occurring after repairs have been made by anyone other than Intelix or any of its authorized service representatives; 6) Acts of nature; 7) Optional software upgrades or updates.

This warranty will be void if the product's serial number or quality control sticker has been removed or defaced, or if the product has been altered, subjected to damage or abuse, repaired by any person not authorized by Intelix to make repairs, or installed in any manner that does not comply with Intelix's recommendations.

This warranty is in lieu of all other warranties, express or implied. Intelix disclaims all other warranties, express or implied, including, but not limited to, implied warranties of merchantability and fitness for a particular purpose.

No agent or reseller of Intelix is authorized to modify this warranty or to make additional warranties on behalf of Intelix. Statements, representations or warranties made by any party other than Intelix does not constitute warranties by Intelix. Intelix shall not be responsible or liable for any statement, representation or warranty made by any other person or party.

Warranty service is only offered after a return authorization (RA) number has been generated by an authorized Intelix factory representative. If you purchased the Intelix goods directly from Intelix, please contact Intelix Applications for an RA number. If you purchased the Intelix good from an authorized Intelix reseller, please contact your authorized reseller for an RA number. This RA number must be clearly referenced on the outside of all packages shipped to Intelix. Intelix Applications must be contacted prior to any return of goods; all return shipments received by Intelix without an RA number will be refused. All shipments must be received within 30 days from the RA number issue date.

At Intelix's option, Intelix will advance replace failing Intelix goods on approved accounts within 90 days of shipment from Intelix. The advanced replaced goods will be invoiced and payment will be due under standard terms if

the failing goods are not received within 14 days of the advanced replacement shipment.

Intelix will match shipping method for units still under warranty. If a unit which is out of warranty needs repair, the dealer must pay for shipping, replacement parts, and a fixed \$100/hr\* labor fee. Normal Intelix credit terms apply to billable repairs. If a unit is returned and found to work according to factory specifications, a \$100 service fee\* is billed regardless of warranty status. All repairs are made in a reasonably quoted amount of time; a rush shipment fee of \$50\* may apply to repairs needing a quicker than usual turn-around time.

All goods outside of the standard warranty period which are repaired by Intelix are covered by an additional 90 day warranty. This 90 day warranty only covers the specific repaired components. All other standard warranty limitations apply.

*\*Or current applicable rate/fee.*

*Warranty terms and conditions subject to change and do not apply outside of United States and Canada.*

*Intelix Warranty is subject to change. Please contact the factory for the most up-to-date information.*

**Thank you for your purchase.**

We appreciate your business. Please contact us with your questions and comments.

Intelix  
2222 Pleasant View Road Suite 1  
Middleton, WI 53562

Phone: 608-831-0880  
Toll-Free: 866-4-MATMIX  
Fax: 608-831-1833

[www.intelix.com](http://www.intelix.com)  
[intelix@intelix.com](mailto:intelix@intelix.com)



Copyright 2009 Intelix LLC.  
**DESIGN WITH INTELLIGENCE**



