

KitchenAid®

KSM1APC

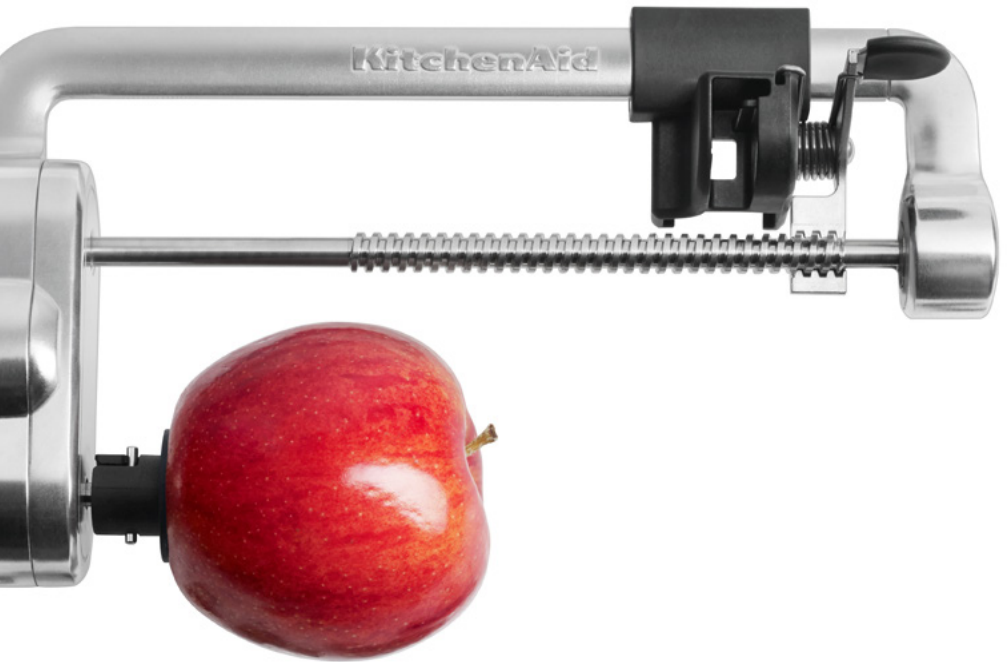

PARTS AND FEATURES

PARTS AND ACCESSORIES

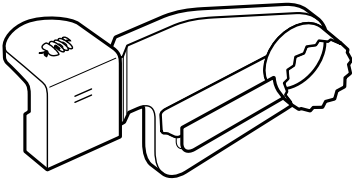

Spiral slice blade with large core

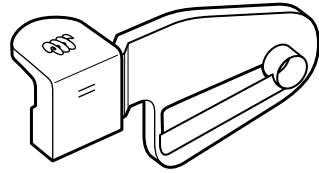

Spiral slice blade with small core

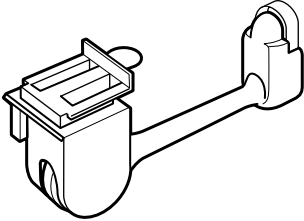

Peeling blade

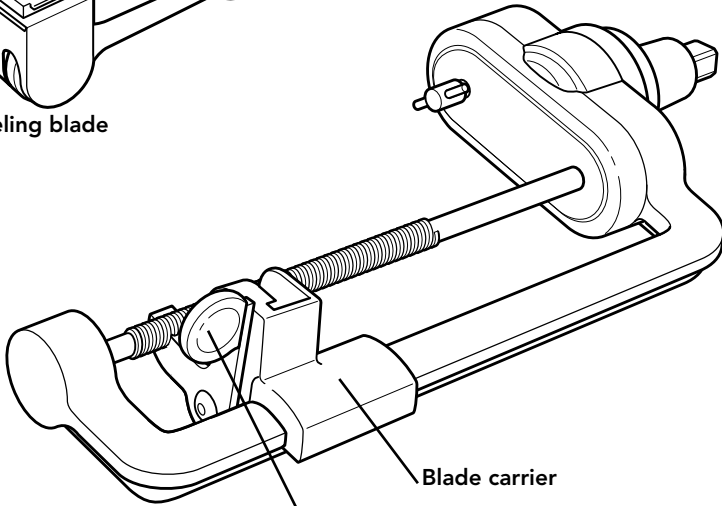

Attachment
main body

Blade carrier

Release lever

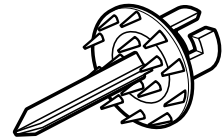

Fruit and vegetable
skewer

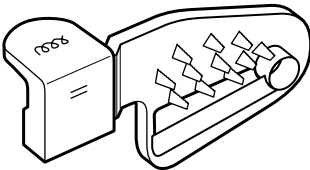

Fine spiraling blade

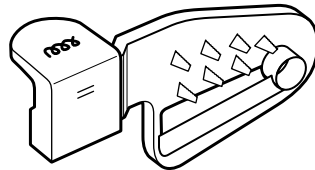

Medium spiraling blade

NOTE: Store your Spiralizer attachment and all accessories in the provided storage box. Be sure to keep out of the reach of small children.

SPIRALIZER ATTACHMENT SAFETY

State of California Proposition 65 Warnings:

WARNING: This product contains one or more chemicals known to the State of California to cause cancer.

WARNING: This product contains one or more chemicals known to the State of California to cause birth defects or other reproductive harm.

IMPORTANT SAFEGUARDS

When using electrical appliances, basic safety precautions should always be followed, including the following:

1. Read all instructions.
2. To protect against risk of electrical shock, do not put Stand Mixer in water or other liquid.
3. Be sure to turn the Stand Mixer OFF (and detach the Spiralizer attachment with peel, core and slice from Stand Mixer) after each use of the Spiralizer attachment and before cleaning. Make sure the motor stops completely before disassembling.
4. Keep hands, utensils or other objects away from the Spiralizer attachment with peel, core & slice blades, skewer or moving parts while it is in operation to reduce the risk of severe injury to persons or damage to the Spiralizer attachment.
5. Never feed by hand. Always use the provided skewer.
6. If food becomes lodged in any blade or the skewer, turn the motor off and disassemble Spiralizer attachment to remove the remaining food.
7. Avoid contacting moving parts.
8. The use of attachments not recommended or sold by KitchenAid may cause fire, electric shock, or injury.
9. Do not use outdoors.
10. Close supervision is necessary when any appliance is used by or near children.
11. Do not use the appliance if the driver mechanism or rotating parts are damaged. Return appliance to the nearest Authorized Service Facility for examination, repair, or electrical or mechanical adjustment.
12. Do not let the Stand Mixer cord hang over the edge of table or counter.
13. Blades are sharp. Handle carefully when inserting or removing blades.
14. Do not remove food until Stand Mixer is OFF and skewer stops.
15. To avoid damaging the gear assembly, do not immerse the Spiralizer attachment main assembly in water or other liquids.







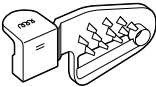
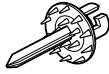
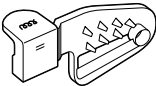
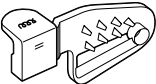

SAVE THESE INSTRUCTIONS

USING THE SPIRALIZER ATTACHMENT

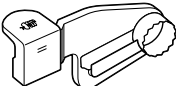
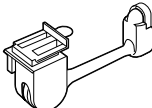
SPIRALIZER ATTACHMENT BLADE CHART

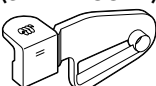
NOTE: Cut the ends off food items to ensure that the food will properly fit on the Spiralizer, and to create flat surfaces for best spiralizing, slicing, and coring results. Food should be 1.5 - 3.75 inches (3.81 - 9.5 cm) in diameter, and no longer than 5.5 inches (14 cm). This step also ensures proper placement onto the fruit and vegetable skewer.

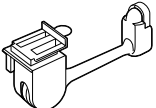
When beginning to cut, start at the “Stir” speed, then adjust to the recommended speed for your blade listed in the chart below.

ICON	USE THESE PARTS	WITH THESE PARTS	SUGGESTED FOODS	SPEED
	<p>FINE SPIRALIZING BLADE</p> 	<p>FRUIT AND VEGETABLE SKEWER and OPTIONAL PEELING BLADE</p> 	ZUCCHINI SWEET POTATO BEET	4
	<p>MEDIUM SPIRALIZING BLADE</p> 		ZUCCHINI SWEET POTATO POTATO	6
	<p>SPIRAL SLICE BLADE (LARGE CORE)</p> 		APPLE PEAR	6
	<p>SPIRAL SLICE BLADE (SMALL CORE)</p> 		ZUCCHINI BEET	4
	<p>PEELING BLADE</p> 	<p>FRUIT AND VEGETABLE SKEWER</p> 	POTATO APPLE	4

Visit [KitchenAid.com/Quickstart](https://www.kitchenaid.com/Quickstart) for additional Instructions with videos, inspiring recipes, and tips on how to use your Spiralizer attachment.

USING THE SPIRALIZER ATTACHMENT

ATTACHING THE SPIRALIZER TO THE STAND MIXER

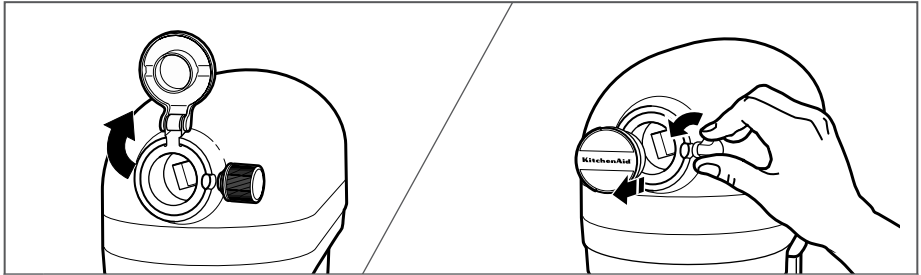

- 1 For Stand Mixers with a hinged attachment hub cover: Flip up to open.
For Stand Mixers with a removable attachment hub cover: Turn the attachment knob counterclockwise to remove attachment hub cover.

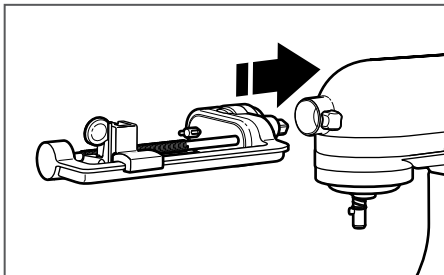

- 2 Insert the Spiralizer attachment shaft housing into the attachment hub, making certain that the power shaft fits into the square hub socket. Rotate the Spiralizer attachment back and forth if necessary. The pin on the shaft housing will slip fully into the notch on the hub rim when it's in the proper position.

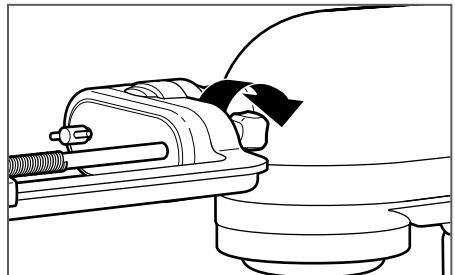

- 3 Tighten the attachment knob until the Spiralizer attachment is completely secured to the Stand Mixer. Visit [KitchenAid.com/Quickstart](https://www.kitchenaid.com/Quickstart) for detailed information on how to use your Spiralizer's different blades and features.

USING THE SPIRALIZER ATTACHMENT

PREPARING TO PROCESS

IMPORTANT: To prepare food before spiralizing, wash food then remove stems, cut the ends off squarely, and remove any eyes, if applicable.

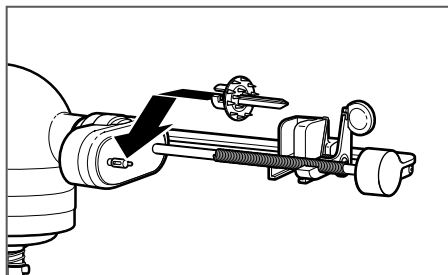

- 1** Install fruit and vegetable skewer by slipping onto the skewer mount, and twisting counterclockwise until it clicks into place.

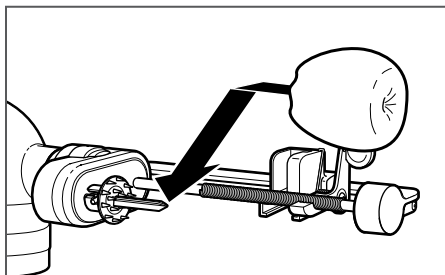

- 2** Place bowl or plate under the Spiralizer attachment, then affix food to the fruit and vegetable skewer.

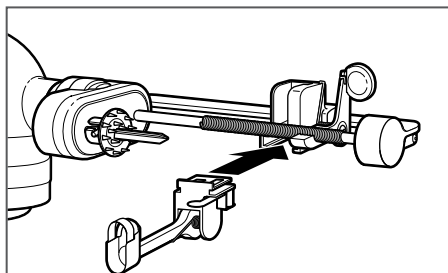

OPTIONAL: If using the peeler, install by sliding into the bottom of the blade carrier until it clicks into place.

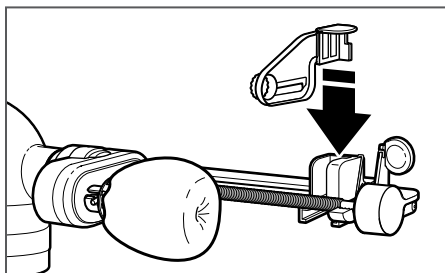

- 3** Install desired blade.

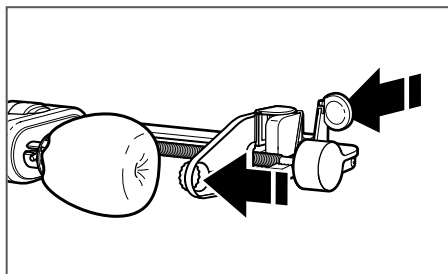

- 4** Pull the release lever, then push the blade carrier towards the Stand Mixer to align the blade core with the center of the food.

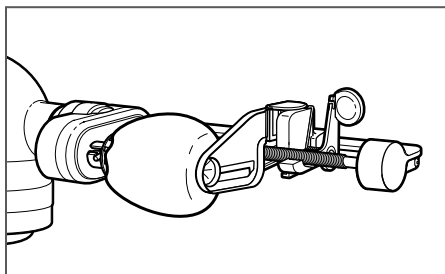

- 5** Press blade core into food for added stability.
IMPORTANT: When finished, remove the blade before removing your food item.

FOR DETAILED INFORMATION ON USING THE SPIRALIZER ATTACHMENT

Visit [KitchenAid.com/Quickstart](https://www.kitchenaid.com/Quickstart) for additional Instructions with videos, inspiring recipes, and tips on how to use your Spiralizer attachment.

CARE AND CLEANING/ TROUBLESHOOTING

CLEANING THE SPIRALIZER ATTACHMENT AND ACCESSORIES

IMPORTANT: To avoid damage, never wash or immerse the Spiralizer attachment main body in water or place in the dishwasher. The removable blades and accessories are dishwasher safe, top rack only.

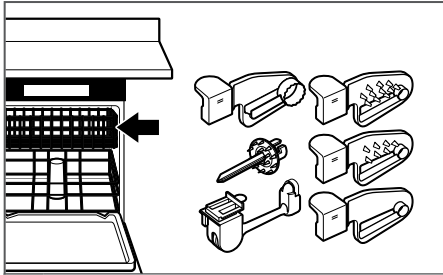

- 1** After using the Spiralizer, remove all blades and accessories. Wash the blades and accessory pieces by hand with a soft cloth, in warm sudsy water; or, wash in the top rack of the dishwasher.

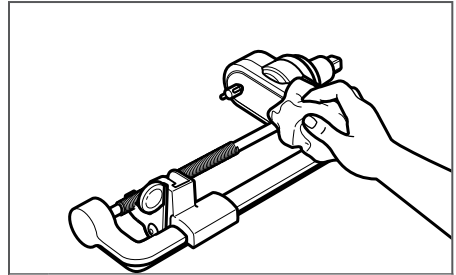

- 2** Clean the Spiralizer attachment main body by hand only. Wash with a soft, damp cloth. Dry thoroughly with a soft dry cloth. Do not wash in the dishwasher. Do not immerse in water.

NOTE: After washing, store your Spiralizer attachment and all accessories in the provided storage box. Be sure to keep out of the reach of small children.

TROUBLESHOOTING

If your Stand Mixer should malfunction or fail to operate while using the Spiralizer attachment, please check the following:

- Did you follow the preparation suggestions in the "Spiralizer attachment blade" chart?
 - Did you choose a blade recommended for the type of food you are spiralizing?
 - Is the Stand Mixer plugged in? Refer to the "Instructions" manual that came with your Stand Mixer to find possible solutions.
 - Is the fuse in the circuit to the Stand Mixer in working order? Refer to the "Instructions" manual that came with your Stand Mixer to find possible solutions.
- If the problem is not due to one of the above items, see the "Arranging for Service" section in the "Warranty".
- Do not return the Spiralizer attachment or the Stand Mixer to the retailer, as they do not provide service.

WARRANTY

KITCHENAID® SPIRALIZER ATTACHMENT WARRANTY FOR THE 50 UNITED STATES, THE DISTRICT OF COLUMBIA, PUERTO RICO, AND CANADA

This warranty extends to the purchaser and any succeeding owner for Spiralizer attachments operated in the 50 United States, the District of Columbia, Puerto Rico, and Canada.

Length of Warranty:	One Year Full Warranty from date of purchase.
KitchenAid Will Pay for Your Choice of:	Hassle-Free Replacement of your Spiralizer attachment. See the next page for details on how to arrange for service, or call the Customer experience Center toll-free at 1-800-541-6390 . OR The replacement parts and repair labor costs to correct defects in materials and workmanship. Service must be provided by an Authorized KitchenAid Service Center.
 KitchenAid Will Not Pay for:	<ul style="list-style-type: none">A. Repairs when your Spiralizer attachment is used in other than normal single family home use.B. Damage resulting from accident, alteration, misuse or abuse.C. Any shipping or handling costs to deliver your Spiralizer attachment to an Authorized Service Center.D. Replacement parts or repair labor costs for Spiralizer attachments operated outside the 50 United States, District of Columbia, Puerto Rico, and Canada.
DISCLAIMER OF IMPLIED WARRANTIES; LIMITATION OF REMEDIES IMPLIED WARRANTIES, INCLUDING TO THE EXTENT APPLICABLE WARRANTIES OF MERCHANTABILITY OR FITNESS FOR A PARTICULAR PURPOSE, ARE EXCLUDED TO THE EXTENT LEGALLY PERMISSIBLE. ANY IMPLIED WARRANTIES THAT MAY BE IMPOSED BY LAW ARE LIMITED TO ONE YEAR, OR THE SHORTEST PERIOD ALLOWED BY LAW. SOME STATES AND PROVINCES DO NOT ALLOW LIMITATIONS OR EXCLUSIONS ON HOW LONG AN IMPLIED WARRANTY OF MERCHANTABILITY OR FITNESS LASTS, SO THE ABOVE LIMITATIONS OR EXCLUSIONS MAY NOT APPLY TO YOU. IF THIS PRODUCT FAILS TO WORK AS WARRANTED, CUSTOMER'S SOLE AND EXCLUSIVE REMEDY SHALL BE REPAIR OR REPLACEMENT ACCORDING TO THE TERMS OF THIS LIMITED WARRANTY. KITCHENAID AND KITCHENAID CANADA DO NOT ASSUME ANY RESPONSIBILITY FOR INCIDENTAL OR CONSEQUENTIAL DAMAGES. This warranty gives you specific legal rights and you may also have other rights which vary from state to state or province to province.	

WARRANTY

HASSLE-FREE REPLACEMENT WARRANTY – 50 UNITED STATES, DISTRICT OF COLUMBIA, AND PUERTO RICO

We're so confident the quality of our products meets the exacting standards of KitchenAid that, if your Spiralizer attachment should fail within the first year of ownership, KitchenAid will arrange to deliver an identical or comparable replacement to your door free of charge and arrange to have your original Spiralizer attachment returned to us. Your replacement unit will also be covered by our one year limited warranty.

If your Spiralizer attachment should fail within the first year of ownership, simply

call our toll-free Customer eXperience Center at **1-800-541-6390** Monday through Friday. Please have your original sales receipt available when you call. Proof of purchase will be required to initiate the claim. Give the consultant your complete shipping address. (No P.O. Box numbers, please.)

When you receive your replacement Spiralizer attachment, use the carton, packing materials, and prepaid shipping label to pack up your original Spiralizer attachment and send it back to KitchenAid.

HASSLE-FREE REPLACEMENT WARRANTY – CANADA

We're so confident the quality of our products meets the exacting standards of the KitchenAid brand that, if your Spiralizer attachment should fail within the first year of ownership, we will replace your Spiralizer attachment with an identical or comparable replacement. Your replacement unit will also be covered by our one year limited warranty.

If your Spiralizer attachment should fail within the first year of ownership, simply call our toll-free Customer eXperience

Center at **1-800-807-6777** Monday through Friday. Please have your original sales receipt available when you call. Proof of purchase will be required to initiate the claim. Give the consultant your complete shipping address.

When you receive your replacement Spiralizer attachment, use the carton, packing materials, and prepaid shipping label to pack up your original Spiralizer attachment and send it back to KitchenAid.

ARRANGING FOR SERVICE AFTER THE WARRANTY EXPIRES, OR ORDERING ACCESSORIES AND REPLACEMENT PARTS

In the United States and Puerto Rico:

For service information, or to order accessories or replacement parts, call toll-free at **1-800-541-6390** or write to:

Customer eXperience Center,
KitchenAid Small Appliances,
P.O. Box 218, St. Joseph, MI 49085-0218

Outside the United States and Puerto Rico:

Consult your local KitchenAid dealer or the store where you purchased the Spiralizer attachment for information on how to obtain service.

For service information in Canada:

Call toll-free **1-800-807-6777**.

For service information in Mexico:

Call toll-free **01-800-0022-767**.

DISCOVER MORE. DÉCOUVREZ PLUS. DESCUBRA MÁS.
KITCHENAID.COM/QUICKSTART



PRODUCT QUESTIONS OR RETURNS
QUESTIONS SUR LE PRODUIT OU LES RETOURS
PREGUNTAS SOBRE EL PRODUCTO O DEVOLUCIONES

USA: 1.800.541.6390 | KitchenAid.com
CANADA: 1.800.807.6777 | KitchenAid.ca

KitchenAid®
FOR THE WAY IT'S MADE.®



®/™ © 2015 KitchenAid. All rights reserved. The design of the Stand Mixer is a trademark in the U.S. and elsewhere. Used under license in Canada.

®/™ © 2015 KitchenAid. Tous droits réservés. La forme du batteur sur socle est une marque de commerce aux É.-U. et ailleurs. Utilisé sous licence au Canada.

®/™ © 2015 KitchenAid. Todos los derechos reservados. El diseño de la batidora con base es una marca registrada en EE.UU. y en otras partes. Usada en Canadá bajo licencia.