



Refrigerator | GNE134750X

Please read this manual before using the product!

Dear Customer,

We'd like you to make the best use of our product, which has been manufactured in modern facilities with care and meticulous quality controls.

Thus, we advise you to read the entire user manual before you use the product. In case the product changes hands, do not forget to hand the guide to its new owner along with the product.

This guide will help you use the product quickly and safely.

- Please read the user guide carefully before installing and operating the product.
- Always observe the applicable safety instructions.
- Keep the user guide within easy reach for future use.
- Please read any other documents provided with the product.

Keep in mind that this user guide may apply to several product models. The guide clearly indicates any variations of different models.

	Important information and useful tips.
	Risk of life and property.
	Risk of electric shock.
	The product's packaging is made of recyclable materials, in accordance with the National Environment Legislation.



This product was manufactured using the latest technology in environmentally friendly conditions.

Table of Contents

1 Safety and environment instructions	3	5 Using the product	14
1.1. General safety	3	5.1. Indicator panel	14
1.1.1 HC warning	4	5.2. Activating the water filter replacing alert . . .	16
1.1.2 For models with water fountain	5	5.3. Taking ice / water	16
1.2. Intended use	5	5.4. Dripping tray	17
1.3. Child safety	5	5.5. Zero degree compartment	17
1.4. Compliance with WEEE Directive and Disposing of the Waste Product	5	5.6. Vegetable bin	17
1.5. Compliance with RoHS Directive	5	5.7. Multi zone storage compartment	18
1.6. Package information	5	5.8. Rotating storage compartment	18
2 Refrigerator	6	5.9. Blue light	18
3 Installation	7	5.10. Ionizer	18
3.1. Right place for installation	7	5.11. Minibar	18
3.2. Attaching the plastic wedges	7	5.12. Freezing fresh food	19
3.3. Adjusting the stands	8	5.13. Recommendations for storing frozen foods	19
3.4. Power connection	8	5.14. Deep freezer details	19
3.5. Water connection	8	5.15. Placing the food	20
3.6. Connecting water hose to the product	9	5.16. Door open alert	20
3.7. Connecting to water mains	9	5.17. Interior light	20
3.8. For products using water carboy	10	6 Maintenance and cleaning	21
3.9. Fixing external filter on the wall (Optional) . . .	11	6.1. Preventing malodour	21
4 Preparation	13	6.2. Protecting plastic surfaces	21
4.1. What to do for energy saving	13	6.3. Cleaning the ice tray	21
4.2. First Use	13	7 Troubleshooting	22

1 Safety and environment instructions

This section provides the safety instructions necessary to prevent the risk of injury and material damage. Failure to observe these instructions will invalidate all types of product warranty.

1.1. General safety

- This product should not be used by persons with physical, sensory and mental disabilities, without sufficient knowledge and experience or by children. The device can only be used by such persons under supervision and instruction of a person responsible for their safety. Children should not be allowed to play with this device.
- In case of malfunction, unplug the device.
- After unplugging, wait at least 5 minutes before plugging in again. Unplug the product when not in use. Do not touch the plug with wet hands! Do not pull the cable to plug off, always hold the plug.
- Wipe the power plug's tip with a dry cloth before plugging in.
- Do not plug in the refrigerator if the socket is loose.
- Unplug the product during installation, maintenance, cleaning and repair.
- If the product will not be used for a while, unplug the product and remove any food inside.
- Do not use steam or steamed cleaning materials for cleaning the refrigerator and melting the ice inside. Steam may contact the electrified areas and cause short circuit or electric shock!
- Do not wash the product by spraying or pouring water on it! Danger of electric shock!
- In case of malfunction, do not use the product, as it may cause electric shock. Contact the authorized service before doing anything.
- Plug the product into an earthed socket. Earthing must be done by a qualified electrician.
- If the product has LED type lighting, contact the authorized service for replacing or in case of any problem.
- Do not touch frozen food with wet hands! It may adhere to your hands!
- Do not place liquids in bottles and cans into the freezer compartment. They may burst out!
- Place liquids in upright position after tightly closing the lid.

Safety and environment instructions

- Do not spray flammable substances near the product, as it may burn or explode.
- Do not keep flammable materials and products with flammable gas (sprays, etc.) in the refrigerator.
- Do not place containers holding liquids on top of the product. Splashing water on an electrified part may cause electric shock and risk of fire.
- Exposing the product to rain, snow, sunlight and wind will cause electrical danger. When relocating the product, do not pull by holding the door handle. The handle may come off.
- Take care to avoid trapping any part of your hands or body in any of the moving parts inside the product.
- Do not step or lean on the door, drawers and similar parts of the refrigerator. This will cause the product to fall down and cause damage to the parts.
- Take care not to trap the power cable.

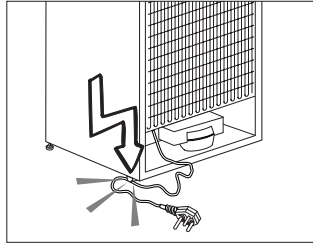

1.1.1 HC warning

If the product comprises a cooling system using R600a gas, take care to avoid damaging the cooling system and its pipe while using and moving the product. This gas is flammable. If the cooling system is damaged, keep the product away from sources of fire and ventilate the room immediately.



The label on the inner left side indicates the type of gas used in the product.

Safety and environment instructions

1.1.2 For models with water fountain

- In order to operate the water circuit of the refrigerator smoothly, the water mains pressure must be between 1-8 bars. For conditions where water mains pressure exceeds 5 bars a pressure regulator should be used. If the water mains pressure exceeds 8 bars then the refrigerator's water circuit should not be connected to the water mains. If you lack the knowledge of how to measure the water mains pressure, please seek a professional support. Use drinking water only.

1.2. Intended use

- This product is designed for home use. It is not intended for commercial use.
- The product should be used to store food and beverages only.
- Do not keep sensitive products requiring controlled temperatures (vaccines, heat sensitive medication, medical supplies, etc.) in the refrigerator.
- The manufacturer assumes no responsibility for any damage due to misuse or mishandling.

- The product's bench life is 10 years. The spare parts necessary for the product to function will be available for this period.

1.3. Child safety

- Keep packaging materials out of children's reach.
- Do not allow the children to play with the product.
- If the product's door comprises a lock, keep the key out of children's reach.

1.4. Compliance with WEEE Directive and Disposing of the Waste Product

This product complies with EU WEEE Directive (2012/19/EU). This product bears a classification symbol for waste electrical and electronic equipment (WEEE).

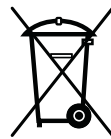

This product has been manufactured with high quality parts and materials which can be reused and are suitable for recycling. Do not dispose of the waste product with normal domestic and other wastes at the end of its service life. Take it to the collection center for the recycling of electrical and electronic equipment. Please consult your local authorities to learn about these collection centers.

1.5. Compliance with RoHS Directive

- This product complies with EU WEEE Directive (2011/65/EU). It does not contain harmful and prohibited materials specified in the Directive.

1.6. Package information

- Packaging materials of the product are manufactured from recyclable materials in accordance with our National Environment Regulations. Do not dispose of the packaging materials together with the domestic or other

2 Refrigerator

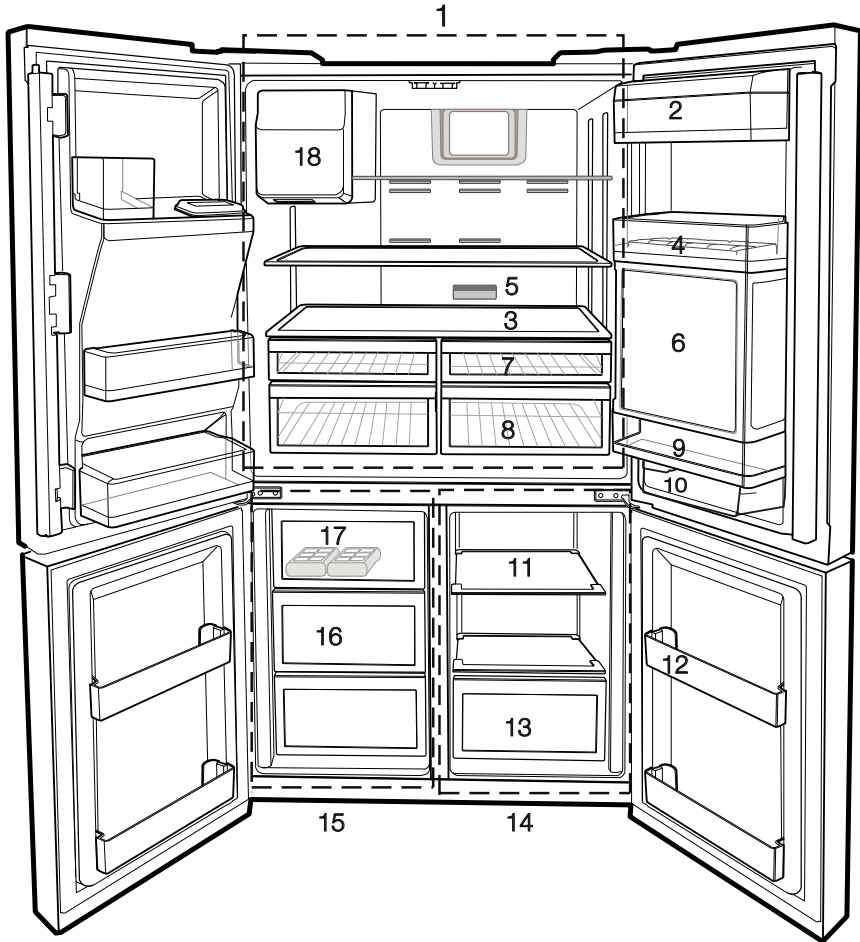

1. Cooler compartment
2. Butter cheese rack
3. Glass rack
4. Eggholder
5. Odour filter
6. Minibar inner cover
7. Zero degree compartments
8. Vegetable bins
9. Cooler compartment door shelves
10. Door rack under storage container
11. Multizone compartment glass racks
12. Freezer compartment door shelves
13. Multi Zone / Flexi Zone / Cool Control compartment food storage compartments
14. Multizone compartment
15. Freezer compartment
16. Frozen or fresh food storage compartment
17. Freezer
18. Ice stock compartment



*Optional: Figures in this user guide are schematic and may not be exactly match your product. If your product does not comprise the relevant parts, the information pertains to other models.

3 Installation

3.1. Right place for installation

Contact the Authorized Service for the product's installation. To ready the product for installation, see the information in the user guide and make sure the electric and water utilities are as required. If not, call an electrician and plumber to arrange the utilities as necessary.



WARNING: The manufacturer assumes no responsibility for any damage caused by the work carried out by unauthorized persons.



WARNING: The product's power cable must be unplugged during installation. Failure to do so may result in death or serious injuries!



WARNING: If the door span is too narrow for the product to pass, remove the door and turn the product sideways; if this does not work, contact the authorized service.

- Place the product on a flat surface to avoid vibration.
- Place the product at least 30 cm away from the heater, stove and similar sources of heat and at least 5 cm away from electric ovens.
- Do not expose the product to direct sunlight or keep in damp environments.
- The product requires adequate air circulation to function efficiently. If the product will be placed in an alcove, remember to leave at least 5 cm distance between the product and the ceiling and the walls.
- Do not install the product in environments with temperatures below -5°C .

3.2. Attaching the plastic wedges

Use the plastic wedges in the provided with the product to provide sufficient space for air circulation between the product and the wall.

1. To attach the wedges, remove the screws on the product and use the screws provided with the wedges.

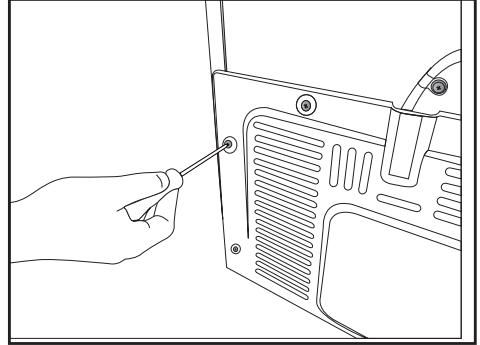

2. Attach 2 plastic wedges on the ventilation cover shown as j in the figure.

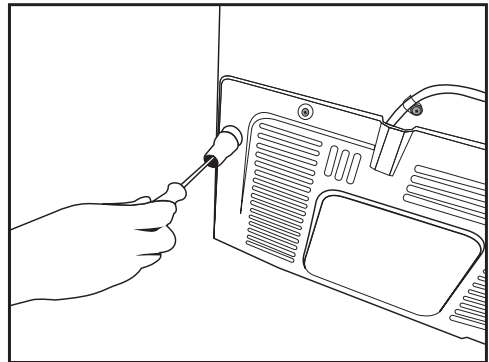

Installation

3.3. Adjusting the stands

If the product is not in balanced position, adjust the front adjustable stands by rotating right or left.

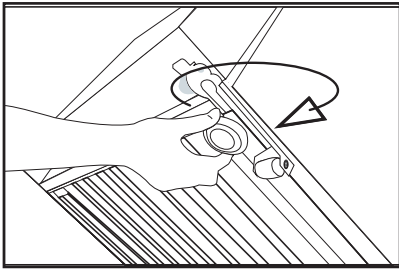
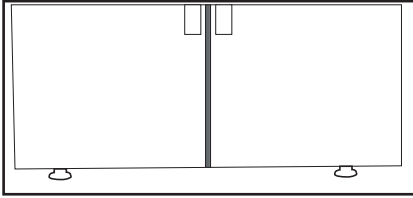

3.4. Power connection



WARNING: Do not use extension or multi sockets in power connection.



WARNING: Damaged power cable must be replaced by Authorized Service.



When placing two coolers in adjacent position, leave at least 4 cm distance between the two units.

- Our firm will not assume responsibility for any damages due to usage without earthing and power connection in compliance with national regulations.
- The power cable plug must be easily accessible after installation.
- Connect the refrigerator to an earthed socket with 220-240V/50 Hz voltage. The plug must comprise a 10-16A fuse.
- Do not use multi-group plug with or without extension cable between the wall socket and the refrigerator.

3.5. Water connection

(Optional)



WARNING: Unplug the product and the water pump (if available) during connection.

The product's water mains, filter and carboy connections must be rendered by authorizer service. The product can be connected to a carboy or directly to the water mains, depending on the model. To establish the connection, the water hose must first be connected to the product.

Check to see the following parts are supplied with your product's model:

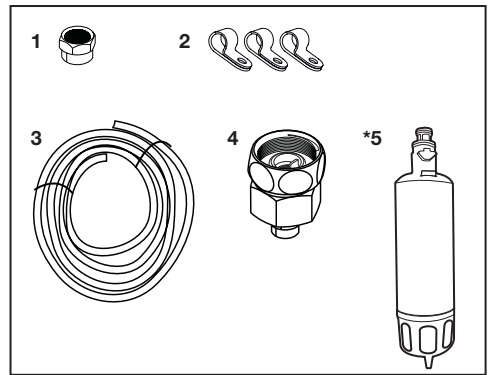

1. Connector (1 piece): Used to attach the water hose to the rear of the product.
2. Hose clip (3 pieces): Used to fix the water hose on the wall.
3. Water hose (1 piece, 5 meter diameter 1/4 inches): Used for the water connection.
4. Faucet adapter (1 piece): Comprises a porous filter, used for connection to the cold water mains.
5. Water filter (1 piece *Optional): Used to connect the mains water to the product. Water filter is not required if carboy connection is available.

Installation

3.6. Connecting water hose to the product

To connect the water hose to the product, follow the instructions below.

1. Remove the connector on the hose nozzle adaptor in the back of the product and run the hose through the connector.

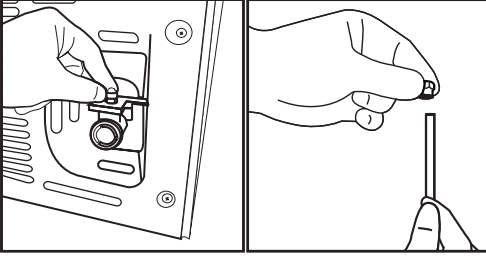

2. Push the water hose down tightly and connect to the hose nozzle adaptor.

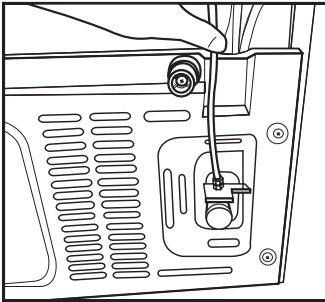

3. Tighten the connector manually to fix on the hose nozzle adaptor. You may also tighten the connector using a pipe wrench or pliers.

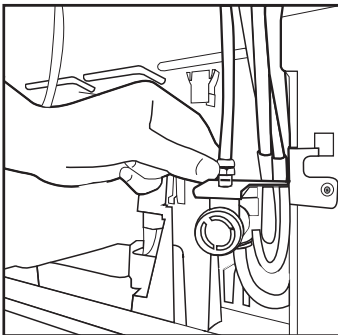

4. Connect the other end of the hose to the water mains (See Section 3.7) or, to use carboy, to the water pump (See Section 3.8).

3.7. Connecting to water mains (Optional)

To use the product by connecting to the cold water mains, a standard 1/2" valve connector must be installed to the cold water mains in your home. If the connector is not available or if you are unsure, consult a qualified plumber.

1. Detach the connector (1) from the faucet adaptor (2).

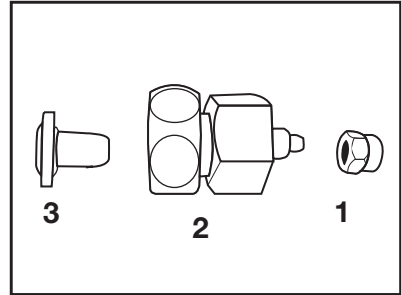

2. Connect the faucet adaptor to the water mains valve.

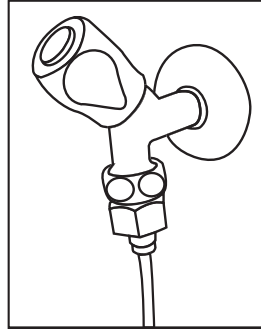

3. Attach the connector around the water hose.

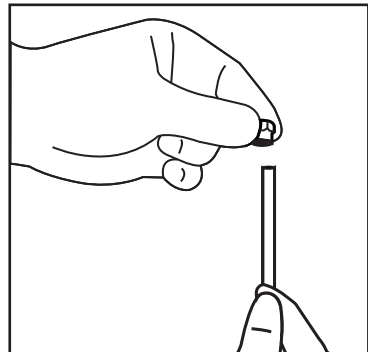

Installation

4. Attach the connector into the faucet adaptor and tighten by hand / tool.

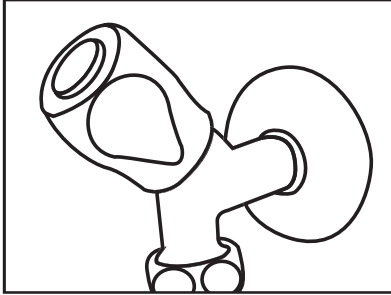

5. To avoid damaging, shifting or accidentally disconnecting the hose, use the clips provided to fix the water hose appropriately.

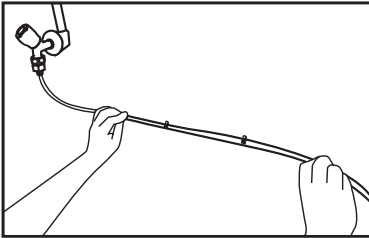

WARNING: After turning the faucet on, make sure there is no water leak on either end of the water hose. In case of leakage, turn the valve off and tighten all connections using a pipe wrench or pliers.

3.8. For products using water carboy (Optional)

To use a carboy for the product's water connection, the water pump recommended by the authorized service must be used.

1. Connect one end of the water hose provided with the pump to the product (see 3.6) and follow the instructions below.

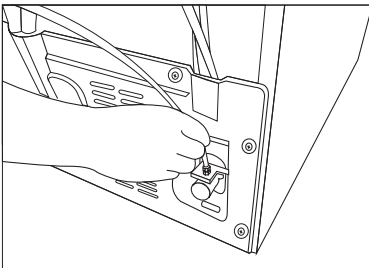

2. Connect the other end of the water hose to the water pump by pushing the hose into the pump's hose inlet.

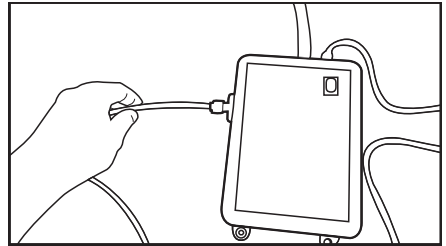

3. Place and fasten the pump hose inside the carboy.

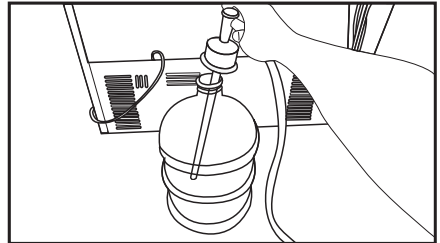

4. Once the connection is established, plug in and start the water pump.



Please wait 2-3 minutes after starting the pump to achieve the desired efficiency.



See also the pump's user guide for water connection.



When using carboy, water filter is not required.

Installation

3.9. Fixing external filter on the wall (Optional)



WARNING: Do not fix the filter on the product.

Check to see the following parts are supplied with your product's model:

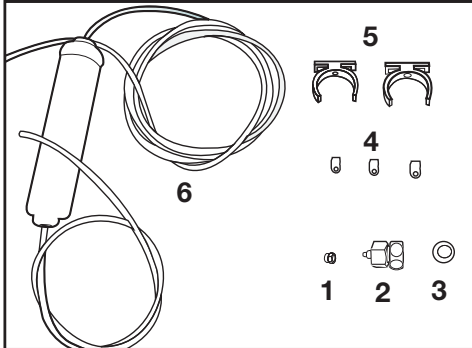

1. Connector (1 piece): Used to attach the water hose to the rear of the product.
2. Faucet adapter (1 piece): Used for connection to the cold water mains.
3. Porous filter (1 piece)
4. Hose clip (3 pieces): Used to fix the water hose on the wall.
5. Filter connecting apparatus (2 pieces): Used to fix the filter on the wall.
6. Water filter (1 piece): Used to connect the product to the water mains. Water filter is not necessary when using carboy connection.

1. Connect the faucet adaptor to the water mains valve.

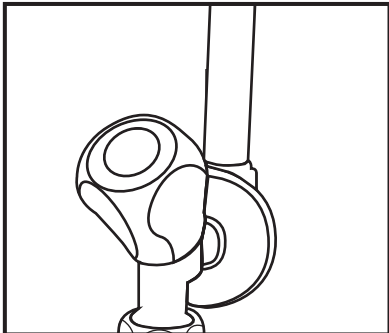

2. Determine the location to fix the external filter. Fix the filter's connecting apparatus (5) on the wall.

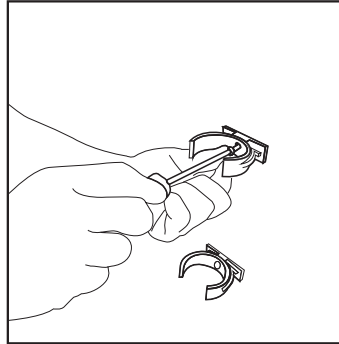

3. Attach the filter in upright position on the filter connecting apparatus, as indicated on the label. (6)

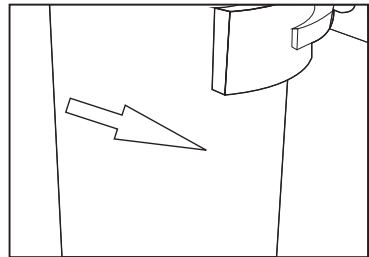
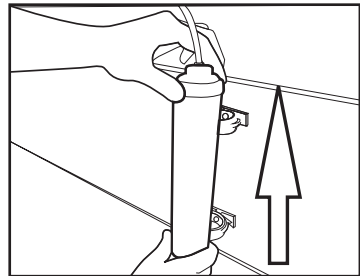

Installation

4. Attach the water hose extending from the top of the filter to the product's water connection adaptor, (see 3.6.)

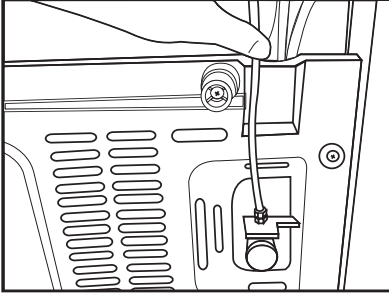

After completing the image below link shall be as specified.

Water line:

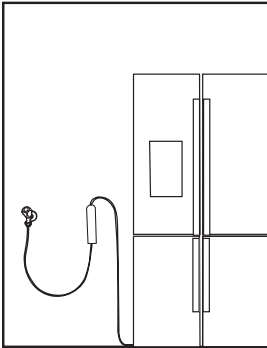

Carboy line:

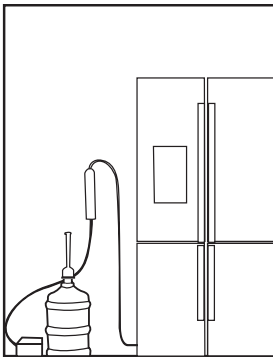

Do not use the first 10 glasses of water after connecting the filter.

4 Preparation

4.1. What to do for energy saving



Connecting the product to electronic energy-saving systems is harmful, as it may damage the product.

- Do not keep the refrigerator doors open for long periods.
- Do not place hot food or beverages into the refrigerator.
- Do not overfill the refrigerator; blocking the internal air flow will reduce cooling capacity.
- The energy consumption value specified for the refrigerator was measured with the freezer compartment's upper shelf removed, other shelves and the lowest drawers in place and under maximum load. The top glass shelf can be used, depending on the shape and size of food to be frozen.
- Depending on the product's features; defrosting frozen foods in the cooler compartment will ensure energy saving and preserve food quality.
- The baskets/drawers that are provided with the chill compartment must always be in use for low energy consumption and for better storage conditions.
- Food contact with the temperature sensor in the freezer compartment may increase energy consumption of the appliance. Thus any contact with the sensor(s) must be avoided.

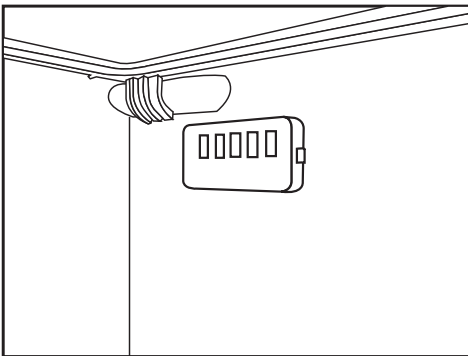

- Make sure the foods are not in contact with the cooler compartment temperature sensor described below.

4.2. First Use

Before using your refrigerator, make sure the necessary preparations are made in line with the instructions in "Safety and environment instructions" and "Installation" sections.

- Keep the product running with no food inside for 6 and do not open the door, unless absolutely necessary.



A sound will be heard when the compressor is engaged. It is normal to hear sound even when the compressor is inactive, due to the compressed liquids and gasses in the cooling system.



It is normal for the front edges of the refrigerator to be warm. These areas are designed to warm up in order to prevent condensation.



In some models, the instrument panel automatically turns off 5 minutes after the door has closed. It will be reactivated when the door has opened or pressed on any key.

5 Using the product

5.1. Indicator panel

Touch screen display panel allows you to adjust the temperature and control other functions of the product without opening the product door. You just need to touch the texts of the related buttons for function settings.

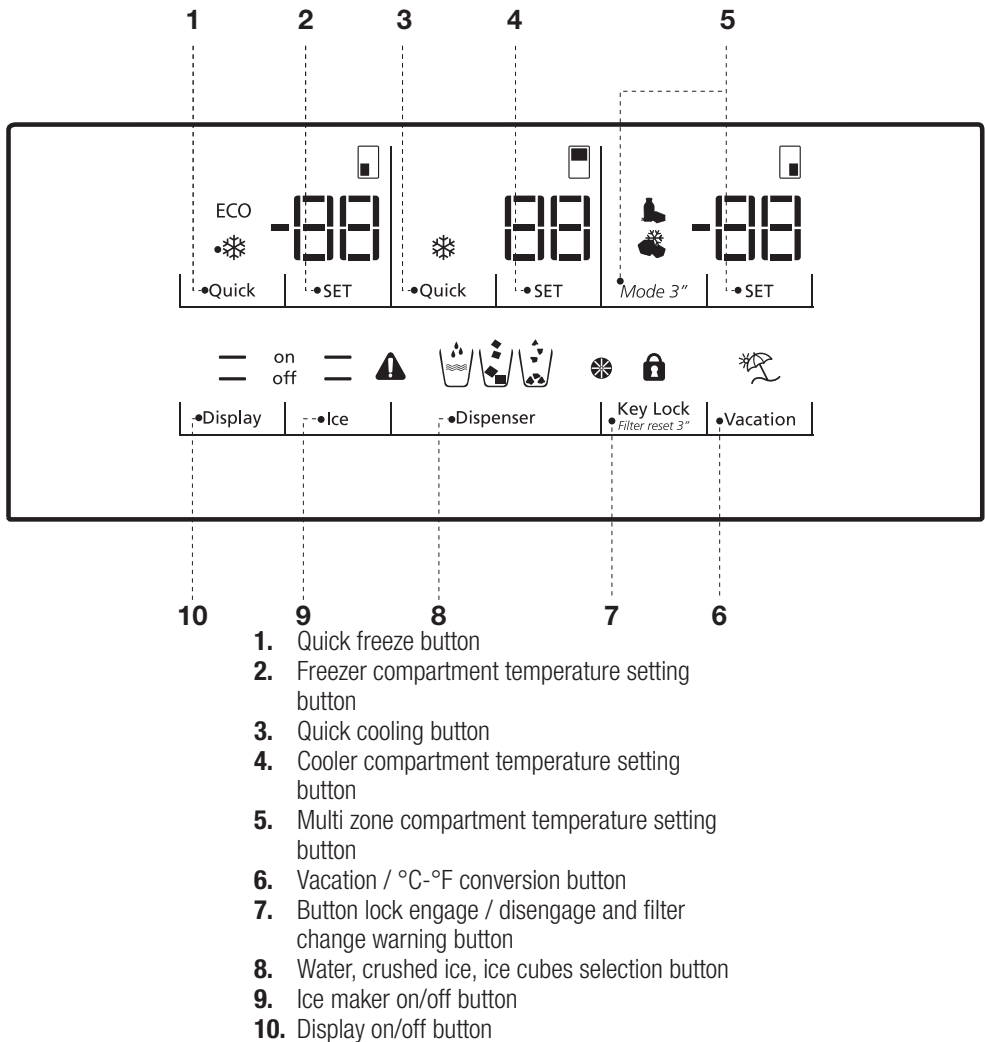

***Optional:** The figures in this user guide are intended as drafts and may not perfectly match your product. If your product does not comprise the relevant parts, the information pertains to other models.

Using the product

1. Rapid freezing

Press button number (1) for quick freezing, quick freezing indicator (❄️) shall activate. Function duration is 2 hours. Press the button again to cancel before this duration.

2. Cooler compartment temperature setting

When the button no (2) is pressed, the freezer compartment temperature can be set to -18, -20, -22, -24, -18... values.

When the Freezer Compartment temperature is set to -18, the (LCO) indicator which indicates that the product runs in economic mode turns on.

3. Rapid cooling

Press button number (3) for quick cooling, quick cooling indicator (❄️) shall activate. Function duration is 2 hours. Press the button again to cancel before this duration.

4. Cooler compartment temperature setting

When the button no (4) is pressed, the cooler compartment temperature can be set to 8, 6, 4, 2, 8... values.

5. Multi zone compartment temperature setting

Keep the Mode button pressed for 3 seconds to set the Multi Zone compartment as freezer or cooler. The compartment is set as freezer as factory default, and it is set as cooler upon pressing the Mode button for 3 seconds. Repeat the same steps to use the compartment as freezer again.

In cooler use, 2, 4, 6, 8, 10 degrees activate on the display and (🌡️) display lights up.

In freezer use, (-6, -18, -20, -22, -24) degrees activate on the display at most and (❄️) display lights up.

6. Vacation function

To activate the vacation function, press the button no (6); vacation mode indicator (🏠) activates.

7. Button lock activation

To activate the button lock, press the button no (7). Function will be terminated upon pressing again.

8. Water, ice, ice cubes selection

You can browse the water (💧), cube ice (🧊), crushed ice (🧊) selections with button no 8. The light of the indicator that you activated will remain on.

9. Ice making

Ice making can be cancelled (🛑) or activated (🧊) pressing the button number (9).

10. Display on/off

Display on/off can be cancelled (🛑) or activated (🧊) pressing the button number (10).

5.2. Activating the water filter replacing alert

(For products connected to water mains and comprising filter)

The water filter replacing alert is adjusted as described below.

1. Press the A (button lock) button while the

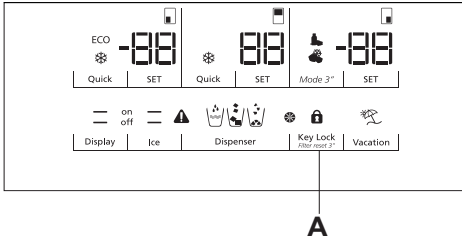

refrigerator is running.

2. Then press the following buttons in order.

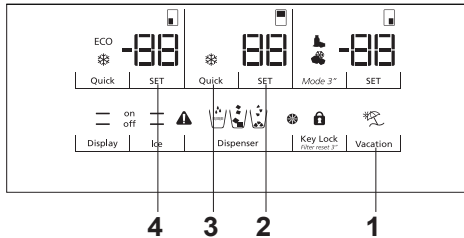

1. Vacation button
2. Cooler temperature adjustment button
3. Rapid cool adjustment button
4. Freezer temperature adjustment button

When the buttons are pressed in the correct order, the button lock indicator turns off, a short sound warning is heard and Filter Change Warning indicator turns on.

The filter service life automatic calculation function is inactive by default. This function must be activated for products comprising a filter.

Your refrigerator will automatically indicate the filter replacement period after 6 months. Repeating this process when the filter service life automatic calculation is active will cancel this function.

5.3. Taking ice / water

(Optional)

Select the related option using the display to take water (☺) / cube ice (☺) / crushed ice (☺). Water/ice can be taken pushing the trigger on the water fountain. When transition is made between cube ice (☺) / crushed ice (☺) options, the ice type from the previous selection can be given in the first few times.

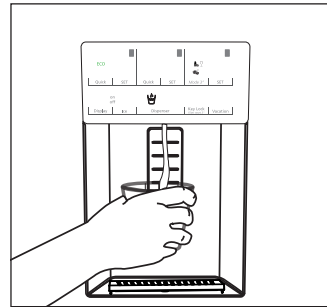

- You must wait approximately 12 hours before taking ice from the ice / water fountain for the first time. The fountain may not discharge ice if there is insufficient ice in the ice box.
- The 30 pieces of ice cubes (3-4 Litres) taken after first operating should not be used.
- In case of power blackout or temporary malfunction, the ice may partly melt and re-freeze. This will cause the ice pieces to merge with each other. In case of extended power blackouts or malfunction, the ice may melt and leak out. If such a problem occurs, clean the ice tray by removing the ice remaining in the ice tray (see 6.3.)



WARNING: The product's water system should be connected to cold water line only. Do not connect to hot water line.

- Water may not be taken when the product is run for the first time. The reason for this is the air inside the system. The air in the system must be discharged. To do this, push the water fountain trigger for 1-2 minutes until the fountain discharges water. The initial water flow may be irregular. The water will flow normally once the air in the system is discharged.

Using the product

- Water may come out dirty when the filter is used for the first time. The first 10 glasses of water should not be consumed.
- You must wait approximately 12 hours to get cold water after first installation.
- The product's water system is designed for clean water only. Do not use any other beverages.
- It is recommended to disconnect the water supply if the product will not be used for long periods during vacation etc.
- The first 1-2 glasses may come out hot if the water fountain has not been used for a long time.

5.4. Dripping tray

(Optional)

The water dripping from the water fountain accumulates on the drip tray; no water drainage is available. Pull the drip tray out or push on the edges to remove the tray. You may then discharge the water inside the drip tray.

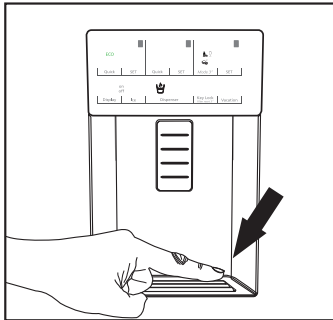

5.5. Zero degree compartment

(Optional)

Use this compartment to store delicatessen products that should be stored in lower temperatures or meat products you shall consume immediately. Do not place vegetables and fruits in this compartment.

You can expand the product's internal volume by removing any of the zero degree compartments. To remove the compartment, simply pull forth, lift up and pull out.

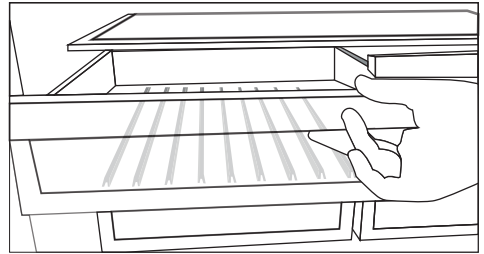

5.6. Vegetable bin

The refrigerator's vegetable bin is designed to keep vegetables fresh by preserving humidity. For this purpose, the overall cold air circulation is intensified in the vegetable bin. Keep fruits and vegetables in this compartment. Keep the green-leaved vegetables and fruits separately to prolong their life.

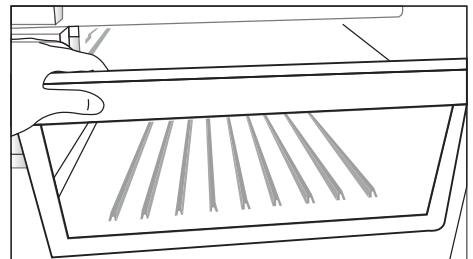

Using the product

5.7. Multi zone storage compartment

You can use the Multi Zone compartment with the mode you desire by setting it to freezer or cooler temperatures (-24 °C , + 10 °C).

- Use -18,-20,-22,-24 to freeze foods,
- Use 2,4,6,8,10 to cool foods,
- Use 0°C to store for delicatessen products and meat products you will consume immediately,
- You can store meats for 3 weeks by freezing them at -6°C.
- 10°C can be used to store rice.



5.8. Rotating storage compartment

(Optional)

This accessory is designed to increase the usage volume under the door rack. As shown in the picture, you can pull it towards yourself holding the tip.

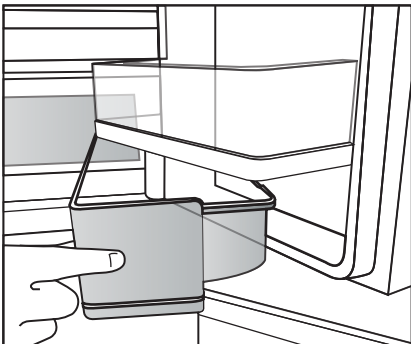

5.9. Blue light

(Optional)

The product's vegetable bins comprise blue light. The vegetables in the bin will continue photosynthesis under the blue light's wavelength effect and remain live and fresh.

5.10. Ionizer

(Optional)

Air is ionized by the ionizing system in the cooler compartment air duct. The propagating negative ions remove the bacteria and other odour-causing molecules from the air.

5.11. Minibar

(Optional)

The refrigerator's minibar door shelf can be accessed without opening the door. This will allow you to easily take frequently consumed food and beverages from the refrigerator. To open the minibar cover, push with your hand and pull towards yourself.



WARNING: Do not sit on the minibar door, to not swing on it and do not place heavy objects on it. This may damage the product or cause you to be injured.

To close this compartment, simply push forward from the upper section of the cover.

Using the product

5.12. Freezing fresh food

- To preserve food quality, the food items placed in the freezer compartment must be frozen as quickly as possible, use the rapid freezing for this.
- Freezing the food items when fresh will extend the storage time in the freezer compartment.
- Pack the food items in air-tight packs and seal tightly.
- Make sure the food items are packed before putting in the freezer. Use freezer holders, tinfoil and damp-proof paper, plastic bag or similar packaging materials instead of traditional packaging paper.
- Mark each food pack by writing the date on the package before freezing. This will allow you to determine the freshness of each pack every time the freezer is opened. Keep the earlier food items in the front to ensure they are used first.
- Frozen food items must be used immediately after defrosting and should not be frozen again.
- Do not free large quantities of food at once.

5.13. Recommendations for storing frozen foods

The compartment must be set to at least -18°C .

1. Place the food items in the freezer as quickly as possible to avoid defrosting.
2. Before freezing, check the "Expiry Date" on the package to make sure it is not expired.
3. Make sure the food's packaging is not damaged.

5.14. Deep freezer details

As per the IEC 62552 standards, the freezer must have the capacity to freeze 4,5 kg of food items at -18°C or lower temperatures in 24 hours for each 100 litres of freezer compartment volume. Food items can only be preserved for extended periods at or below temperature of -18°C . You can keep the foods fresh for months (in deep freezer at or below temperatures of 18°C).

The food items to be frozen must not contact the already-frozen food inside to avoid partial defrosting.

Boil the vegetables and filter the water to extend the frozen storage time. Place the food in air-tight packages after filtering and place in the freezer. Bananas, tomatoes, lettuce, celery, boiled eggs, potatoes and similar food items should not be frozen. Freezing these food items will simply reduce the nutritional value and food quality, as well as possible spoiling which is harmful to health.

Freezer Compartment Setting	Cooler Compartment Setting	Descriptions
-18°C	4°C	This is the default, recommended setting.
$-20, -22$ veya -24°C	4°C	These settings are recommended for ambient temperatures exceeding 30°C .
Rapid Freeze	4°C	Use this to freeze food items in a short time, the product will reset to previous settings when the process is completed.
-18°C or colder	2°C	Use these settings if you believe the cooler compartment is not cold enough due to ambient temperature or frequently opening the door.

Using the product

5.15.Placing the food

Freezer compartment shelves	Various frozen goods including meat, fish, ice cream, vegetables etc.
Cooler compartment shelves	Food items inside pots, capped plate and capped cases, eggs (in capped case)
Cooler compartment door shelves	Small and packed food or beverages
Vegetable bin	Fruits and vegetables
Fresh food compartment	Delicatessen (breakfast food, meat products to be consumed in short notice)

5.16.Door open alert

(Optional)

An audible alert will be heard if the product's door remains open for 1 minute. The audible alert will stop when the door is closed or any button on the display (if available) is pressed.

5.17.Interior light

Interior light uses a LED type lamp. Contact the authorized service for any problems with this lamp. The lamp(s) used in this appliance is not suitable for household room illumination. The intended purpose of this lamp is to assist the user to place foodstuffs in the refrigerator/freezer in a safe and comfortable way.

6 Maintenance and cleaning

Cleaning the product regularly will prolong its service life.



WARNING: Disconnect the power before cleaning the refrigerator.

- Do not use sharp and abrasive tools, soap, house cleaning materials, detergents, gas, gasoline, varnish and similar substances for cleaning.
- Melt a teaspoonful of carbonate in the water. Moisten a piece of cloth in the water and wring out. Wipe the device with this cloth and dry off thoroughly.
- Take care to keep water away from the lamp's cover and other electrical parts.
- Clean the door using a wet cloth. Remove all items inside to detach the door and chassis shelves. Lift the door shelves up to detach. Clean and dry the shelves, then attach back in place by sliding from above.
- Do not use chloric water or cleaning products on the exterior surface and chrome-coated parts of the product. Chlorine will cause rust on such metallic surfaces.

6.1. Preventing malodour

The product is manufactured free of any odorous materials. However, keeping the food in inappropriate sections and improper cleaning of internal surfaces may lead to malodour.

To avoid this, clean the inside with carbonated water every 15 days.

- Keep the foods in sealed holders. Microorganisms may spread out of unsealed food items and cause malodour.
- Do not keep expired and spoilt foods in the refrigerator.

6.2. Protecting plastic surfaces

Oil spilled on plastic surfaces may damage the surface and must be cleaned immediately with warm water.

6.3. Cleaning the ice tray

(Optional)

1. To remove the ice tray, turn the knob on the arm and remove the tray.

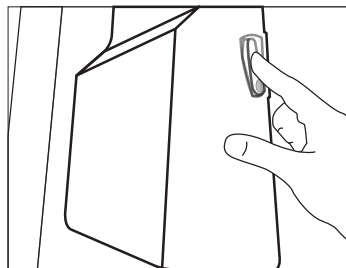

2. Clean the area inside the ice tray where the spiral is located with water, without using any chemical.

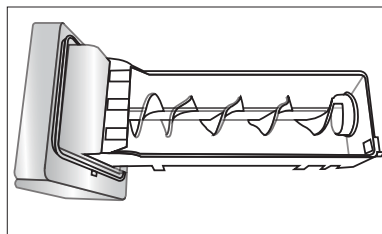

3. When placing the tray, make sure that the corresponding parts (see. 1-2) fit onto each other. Make sure that the spiral inside the tray is in suitable position. Do not touch the moving parts.

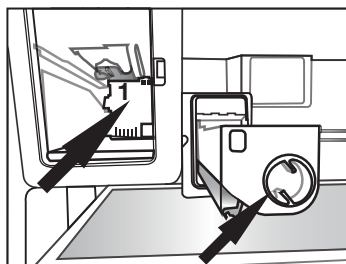

7 Troubleshooting

Check this list before contacting the service. Doing so will save you time and money. This list includes frequent complaints that are not related to faulty workmanship or materials. Certain features mentioned herein may not apply to your product.

The refrigerator is not working.

- The power plug is not fully settled. >>> *Plug it in to settle completely into the socket.*
- The fuse connected to the socket powering the product or the main fuse is blown. >>> *Check the fuses.*

Condensation on the side wall of the cooler compartment (MULTI ZONE, COOL, CONTROL and FLEXI ZONE).

- The environment is too cold. >> *Do not install the product in environments with temperatures below -5°C.*
- The door is opened too frequently >>> *Take care not to open the product's door too frequently.*
- The environment is too humid. >>> *Do not install the product in humid environments.*
- Foods containing liquids are kept in unsealed holders. >>> *Keep the foods containing liquids in sealed holders.*
- The product's door is left open. >>> *Do not keep the product's door open for long periods.*
- The thermostat is set to too low temperature. >>> *Set the thermostat to appropriate temperature.*

Compressor is not working.

- In case of sudden power failure or pulling the power plug off and putting back on, the gas pressure in the product's cooling system is not balanced, which triggers the compressor thermic safeguard. The product will restart after approximately 6 minutes. If the product does not restart after this period, contact the service.
- Defrosting is active. >>> *This is normal for a fully-automatic defrosting product. The defrosting is carried out periodically.*
- The product is not plugged in. >>> *Make sure the power cord is plugged in.*
- The temperature setting is incorrect. >>> *Select the appropriate temperature setting.*
- The power is out. >>> *The product will continue to operate normally once the power is restored.*

The refrigerator's operating noise is increasing while in use.

- The product's operating performance may vary depending on the ambient temperature variations. This is normal and not a malfunction.

The refrigerator runs too often or for too long.

- The new product may be larger than the previous one. Larger products will run for longer periods.
- The room temperature may be high. >>> *The product will normally run for long periods in higher room temperature.*
- The product may have been recently plugged in or a new food item is placed inside. >>> *The product will take longer to reach the set temperature when recently plugged in or a new food item is placed inside. This is normal*
- Large quantities of hot food may have been recently placed into the product. >>> *Do not place hot food into the product.*
- The doors were opened frequently or kept open for long periods. >>> *The warm air moving inside will cause the product to run longer. Do not open the doors too frequently.*
- The freezer or cooler door may be ajar. >>> *Check that the doors are fully closed.*
- The product may be set to temperature too low. >>> *Set the temperature to a higher degree and wait for the product to reach the adjusted temperature.*
- The cooler or freezer door washer may be dirty, worn out, broken or not properly settled. >>> *Clean or replace the washer. Damaged / torn door washer will cause the product to run for longer periods to preserve the current temperature.*

Troubleshooting

The freezer temperature is very low, but the cooler temperature is adequate.

- The freezer compartment temperature is set to a very low degree. >>> *Set the freezer compartment temperature to a higher degree and check again.*

The cooler temperature is very low, but the freezer temperature is adequate.

- The cooler compartment temperature is set to a very low degree. >>> *Set the freezer compartment temperature to a higher degree and check again.*

The food items kept in cooler compartment drawers are frozen.

- The cooler compartment temperature is set to a very low degree. >>> *Set the freezer compartment temperature to a higher degree and check again.*

The temperature in the cooler or the freezer is too high.

- The cooler compartment temperature is set to a very high degree. >>> *Cooler compartment temperature setting has an effect on the freezer compartment temperature. Change the temperature of the cooler or freezer compartment and wait until the temperature of the related compartments come to the adequate level.*
- The doors were opened frequently or kept open for long periods. >>> *Do not open the doors too frequently.*
- The door may be ajar. >>> *Fully close the door.*
- The product may have been recently plugged in or a new food item is placed inside. >>> *This is normal. The product will take longer to reach the set temperature when recently plugged in or a new food item is placed inside.*
- Large quantities of hot food may have been recently placed into the product. >>> *Do not place hot food into the product.*

Shaking or noise.

- The ground is not level or durable. >>> *If the product is shaking when moved slowly, adjust the stands to balance the product. Also make sure the ground is sufficiently durable to bear the product.*
- Any items placed on the product may cause noise. >>> *Remove any items placed on the product.*

The product is making noise of liquid flowing, spraying etc.

- The product's operating principles involve liquid and gas flows. >>> *This is normal and not a malfunction.*

There is sound of wind blowing coming from the product.

- The product uses a fan for the cooling process. This is normal and not a malfunction.

There is condensation on the product's internal walls.

- Hot or humid weather will increase icing and condensation. This is normal and not a malfunction.
- The doors were opened frequently or kept open for long periods. >>> *Do not open the doors too frequently; if open, close the door.*
- The door may be ajar. >>> *Fully close the door.*

There is condensation on the product's exterior or between the doors.

- The ambient weather may be humid, this is quite normal in humid weather. >>> *The condensation will dissipate when the humidity is reduced.*

Troubleshooting

The interior smells bad.

- The product is not cleaned regularly. >>> *Clean the interior regularly using sponge, warm water and carbonated water.*
- Certain holders and packaging materials may cause odour. >>> *Use holders and packaging materials without free of odour.*
- The foods were placed in unsealed holders. >>> *Keep the foods in sealed holders. Microorganisms may spread out of unsealed food items and cause malodour.*
- Remove any expired or spoilt foods from the product.

The door is not closing.

- Food packages may be blocking the door. >>> *Relocate any items blocking the doors.*
- The product is not standing in full upright position on the ground. >>> *Adjust the stands to balance the product.*
- The ground is not level or durable. >>> *Make sure the ground is level and sufficiently durable to bear the product.*

The vegetable bin is jammed.

- The food items may be in contact with the upper section of the drawer. >>> *Reorganize the food items in the drawer.*



WARNING: If the problem persists after following the instructions in this section, contact your vendor or an Authorized Service. Do not try to repair the product.

