



X17s

4 Relay | 4 Input Expansion Module

USERS MANUAL

Revision 1.0

For models: X-17s

4 Relays and 4 Digital Inputs • Removable Connector



- ▶ Indicator Lights
- ▶ Button/Switch Inputs
- ▶ Alarms
- ▶ Interface with a PLC
- ▶ Machine Status

CONTROL by **WEB**™
www.ControlByWeb.com

a division of Xytronix Research & Design, Inc.
located in Nibley, Utah, USA

© 2015 Xytronix Research and Design, Inc.

X-17s User Manual Revisions	
Revision	Description
1.0	Initial release

Section 1: Introduction

The X-17s™ expansion module is used in conjunction with the X-600M controller. The X-17s is a multi-function module with four relays and four optically-isolated digital inputs. One or more X-17s expansion modules can be connected to a X-600M control module with a ribbon cable which provides both power and communications.

The four relays have Form-A contacts (SPST) and can be used to control moderate loads such as solenoid valves, alarms and indicator lights.

The isolated inputs are suitable for use in industrial environments and allow the grounding system of the monitored equipment and the low voltage circuits of the X-17s to be electrically separate. Internally the X-17s has a co-processor which provides enhanced features including: pulse counting, pulse duration, accumulated pulse time and frequency measurements. All 4-inputs have separate measurements. Programmable de-bounce timers allow glitches and short pulses to be filtered out.

The X-600M is a multifunction web-enabled industrial I/O controller. It performs control, logic, and monitoring functions similar to that of a Programmable Logic Controller (PLC). However, unlike a PLC, the X-600M is designed for web-based applications from the ground up. No add-on software or hardware is required. The X-600M can be fully configured, programmed and tested using its built-in web server. The web setup pages are intuitive and easy to use and do not require special programming skills.

The X-600M together with the X-17s provides an easy, flexible and reliable way to monitor sensors and control devices over a network. The X-17s is suitable for use with security systems, freezer doors, light switches and water meters, as well as with moderate loads such as solenoid valves, alarms and indicator lights.



1.1 Connectors & Indicators

Relays

The X-17s has four relays. Terminals are provided for the *Common* and *Normally Open* contacts of each relay. A plug-in screw terminal makes it easy to make the wiring connections. The connector terminals are wired directly to the internal relays with no internal fuse or other over current protection. The relays are isolated from all other circuits inside. When a relay coil is energized, the contacts are closed. The load device that is connected to the relay contacts will be on when the coil is energized.

Digital Inputs

The X-17s has four optically-isolated digital inputs. The inputs are connected with a common return (negative) connection for the four inputs. The optically-isolated inputs provide 3KV electrical isolation between the digital inputs and the low voltage control circuits of the X-600M.

Expansion Bus

The expansion bus allows for a family of expansion modules to be connected directly to the X-600M without the need for an Ethernet switch. The cable can be a daisy chain with multiple connectors. The ribbon cable expansion bus provides both power and communications connections.

Power Supply

The expansion bus can provide up to 1.7 Amps for powering up to 32 expansion modules; however, the maximum number of expansion modules depends on the module type and power source attached to the X-600M.

The X-17s employs modern switch-mode power supply. With this type of power supply the current draw decreases as the voltage increases; therefore, you can add more expansion modules by using a 24-volt power supply than you can with a 12-volt power supply. See the *X-600M User Manual* for more details.

Indicators

The green Power LED indicator is illuminated whenever the module is powered. To identify the module during installation, the X-600M can send a blink command which will cause the power LED to blink for three seconds. Eight, yellow LEDs indicate the status of the relays and digital inputs and are illuminated when the respective relay coils are energized or a voltage is applied to the respective opto-coupler.

1.2 Part Numbers and Accessories

Accessory	Description	Part Number
X-17s	Expansion module with 4-digital inputs and 4-relays 120VAC relays, 4-26VDC inputs	X-17s
Spare Connector	14-position, screw-terminal connector	X-1803691

1.3 Measurement Functions

The internal co-processor monitors the digital inputs and provides enhanced features including: pulse counting, pulse duration, accumulated pulse time and frequency measurements. All four inputs have separate measurements. The following measurements are made:

Input State

This register is the current (asynchronously sampled) status of the digital inputs.

High Time

These registers measure the pulse width of the most recent pulse. These are 32-bit values with a resolution of 0.977mS. ($1/1024 \times 2^{32} = 4,194,304$ seconds max.) The registers are reset with a rising edge, are updated while the input is asserted and remain unchanged until the next rising edge. The counters are qualified by the respective de-bounce timer settings.

ON Time

These registers measure the accumulated (total) time the respective inputs are asserted. If the input is configured for rising edge pulses the counters advance when the opto-couplers are ON. If the input is configured for falling edge pulses the counters advance when the opto-couplers are OFF. The On-Time counters do nothing when the edge is set to both rise and fall. These counters are 32-bit values with a resolution of 0.977mS. ($1/1024 \times 2^{32} = 4,194,304$ seconds max). The input state for the *On-Time* counters is polled at a 1024Hz rate and are not qualified by the respective de-bounce timer settings.

This measurement could be used to measure the total operating time of a pump or machine. The measurement would indicate the total hours the pump or machine has operated since the *On-Time* register was reset.

Count

These registers measure the total number of pulse transitions (rise, fall or both) that have occurred on the respective inputs. The counters are qualified by the respective de-bounce timer settings. The counters are 32-bit which allows operation with paddle-wheel flow meters and other devices which output a large number of pulses.

Frequency

These registers measure the total number of pulses that have occurred over a 1.00 second interval. The measurement is updated precisely once per second. Since the event counters are qualified by the respective de-bounce timer settings, the frequency measurements are also qualified by the de-bounce settings.

Note: *If the count mode is set to rise and fall the resulting frequency measurement will be the number of rise and fall edges that have occurred in 1-second.*

De-bounce Time

The high-time, count and frequency functions employ a de-bounce timer for each input. The internal processor periodically polls the input state. If the appropriate edge (rise, fall or both) is detected, a timer is initialized to the respective de-bounce value. If the input state subsequently changes (a glitch) the timer is restarted. When the input stabilizes, the debounce timer eventually expires and the appropriate high-time or event counter is advanced.

Section 2: Installation and Connections

Installation consists of mounting the X-17s and connecting it to an X-600M controller with a 10-conductor ribbon cable. Programming and testing is done by using a web browser to configure the web pages, inputs, and outputs for your specific needs.

2.1 Installation Guidelines

- This unit must be installed by qualified personnel.
- This unit must not be installed in unprotected outdoor locations.
- This unit must not be used for medical, life saving purposes, or for any purpose where its failure could cause serious injury or the loss of life.
- This unit must not be used in any way where its function or failure could cause significant loss or property damage.

2.2 Mounting

X-17s can be mounted to a standard (35mm by 7.55mm) DIN-Rail. Normally expansion modules are mounted to the left side (embossed logo side of the enclosure) of the X-600M controller so that the ribbon cable doesn't cover the power connector. The X-17s should be located in a clean, dry location where it is protected from the elements. Ventilation is recommend for installations where high ambient air temperatures are expected to be high. See *Appendix D: Mechanical Information* for additional mechanical details.

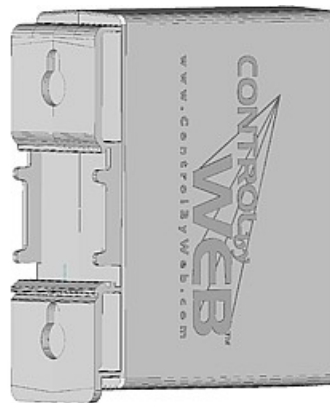

2.2.1 DIN-Rail Mounting

Attach the X-17s to the DIN-Rail by hooking the top hook on the back of the enclosure to the DIN-Rail and then snap the bottom hook into place. To remove the X-17s from the DIN-Rail, use a flat-head screwdriver. Insert the screw driver into the notch in the release tab and pry against the enclosure to release the bottom hook.

2.3 Making Connections

CAUTION: Make sure the power is shut off before making connections

CAUTION: This unit should be installed by a qualified technician.

CAUTION: Miswiring or misconfiguration could cause permanent damage to the X-17s, the equipment to which it is connected, or both.

A removable terminal connector is provided for making the power connections. The correct wiring procedure is as follows:

1. Make sure power is turned off.
2. Remove the terminal connector from the X-17s and make wiring connections to the terminals. This technique avoids stressing the internal components while torquing the screws.
3. Reconnect the terminal connector.
4. Apply power.

It is recommended that any load (device to be controlled) not be connected to the expansion modules until after the X-600M has been configured and tested. By doing this, wiring and configuration mistakes will not cause the load device to turn on unexpectedly.

Make certain the wires are properly inserted into to the terminals and that the screws are tight.

Wire Specification:

Use wire rated for 75°C (min) for connections to the terminal blocks

Connector Specifications:

Type:	14-position, removable, 3.81 mm pitch
Connection wire:	Use wire rated for 75°C (min) for connections to the terminal blocks
Stripping Length:	7mm
Connection capacity:	1.5mm ² stranded, 1.5mm ² solid
Conductor minimum:	30AWG (UL/CUL)
Conductor maximum:	14 AWG (UL/CUL)
Conductor Type:	Copper
Tightening torque:	0.22 Nm (min), 0.25 Nm (max)

14-Pin Wiring Connections	
Terminal	Description
1A	Relay 1 NO
1B	Relay 1 COM
2A	Relay 2 NO
2B	Relay 2 COM
3A	Relay 3 NO
3B	Relay 3 COM
4A	Relay 4 NO
4B	Relay 4 COM
1+	Input 1(+), Positive side of optically isolated input 1
2+	Input 2(+), Positive side of optically isolated input 2
3+	Input 3(+), Positive side of optically isolated input 3
4+	Input 4(+), Positive side of optically isolated input 4
Com	Input COM, Negative side of optically isolated inputs 1 thru 4
Com	Input COM, Negative side of optically isolated inputs 1 thru 4

2.4 Optically-Isolated Input Connections

Internally each input is connected thru a current limiting resistor directly to an opto-isolator. No external resistor is necessary as long as the input signal is within the proper range. With the X-600M, the optically-isolated inputs can be used to control relays and remote relays (over the network), or simply to monitor the state of a discrete device. To use these inputs, connect a DC control voltage directly to the input, and set up the input function using the configuration pages.

2.4.1 DC Inputs

With DC inputs, no external components are required as long as the maximum input voltage is not exceeded (See *Specifications*). A DC voltage can be reduced with an external resistor of the appropriate value and power rating to reduce the input current. See *Section 3.2*.

2.4.2 AC Inputs

If an AC signal voltage needs to be detected, use a signal conditioner to convert the AC signal to a DC voltage within the input range. An AC signal conditioner can be made using a diode (or bridge rectifier) and a capacitor. Prepackaged signal converters are available as accessories at industrial automation distributors. A simple voltage converter module manufactured by www.redlion.net is shown below. These are available in two input voltage ranges that cover the spectrum from 4-270VAC/DC. These devices have a MOSFET output (solid state DC contact closure) which is compatible with the X-17s input. The converter module accepts AC (50/60 Hz) or DC voltages at input cycles up to 30 Hz. The converter provides isolation between the input and output using an opto-isolator. You must provide a voltage source for the input of the X-17s as shown in the example below:

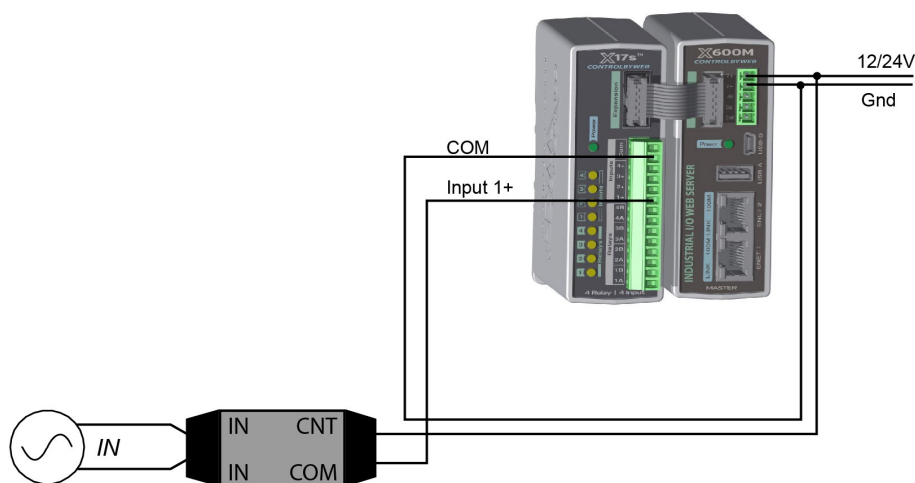

Section 3: Example Applications

3.1 Monitor a gate position over an IP network

The illustration below shows an example of using the X-17s to monitor the status of a gate or door over an IP network. The status of the device is detected with a switch. These type of sensors are called “dry contacts” in that the device output is a bare switch with no power source. A voltage source for the dry-contact switch must be provided (this could be via the power supply for the X-600M).

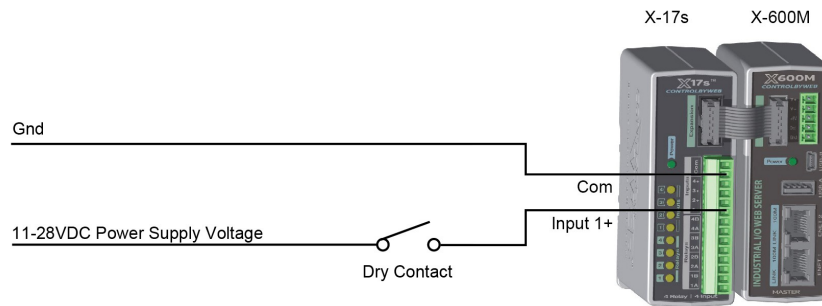

3.2 Monitor a sensor with a high voltage output

To monitor a DC voltage that is greater than the input rating of the X-17s, a series resistor can be used to reduce the input current.

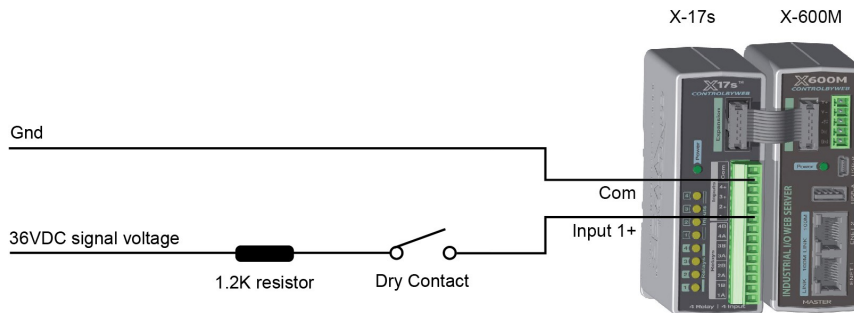

The formula to calculate external resistor values is provided below:

The X-17s draws 8mA at 26V:

$$R = (V-26)/0.008$$

Where: V = Desired Vin

R = External resistor value required. The external resistor must also be rated with a minimum power value (minWatts=(V-26)x0.008)

For example to connect a 36VDC signal voltage to the X-17s:

$R = (36-26)/0.008=1250$ Ohm resistor. The resistor must be at least $(36-26) \times 0.008 = 0.08$ Watts. A 1200 Ohm, 1/4watt resistor would be suitable.

3.3 Monitor the digital outputs of a PLC

The illustration below shows a simple example connecting the digital outputs from a PLC to an X-17s Input Module. In this example the voltage for the inputs is provided by the PLC so no other excitation voltage is needed.

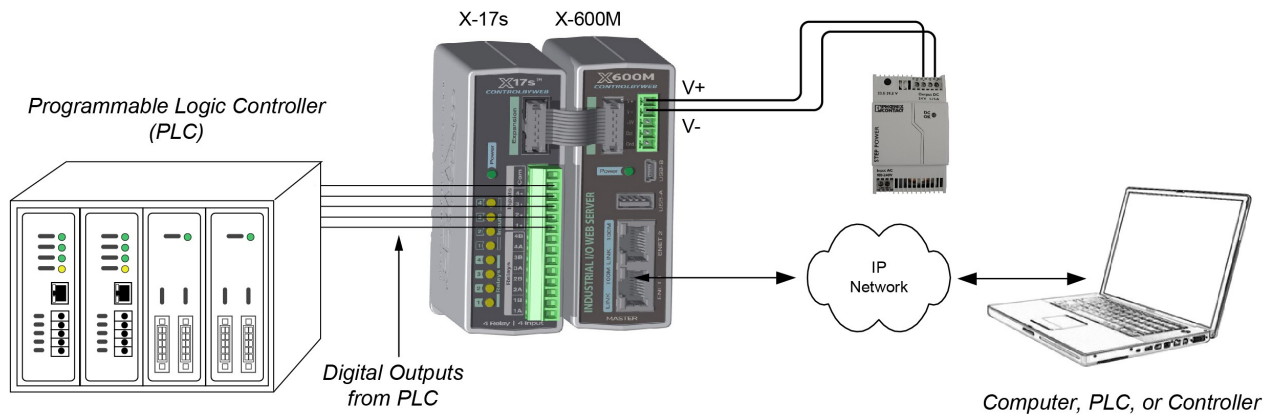

3.4 Bridge switches to a remote location

The illustration below shows an example where digital signals are bridged to a remote location on the network. A control voltage applied to the X-17s input module controls relay contacts of a WebRelay-Quad™ (or any other ControlByWeb devices) at a remote location.

In this example three switches are connected to an X-17s and a remote WebRelay-Quad controls three indicator lights. The switches and indicator lights can be in separate buildings. With this setup the high/low liquid level of a tank could be monitored at a remote location.

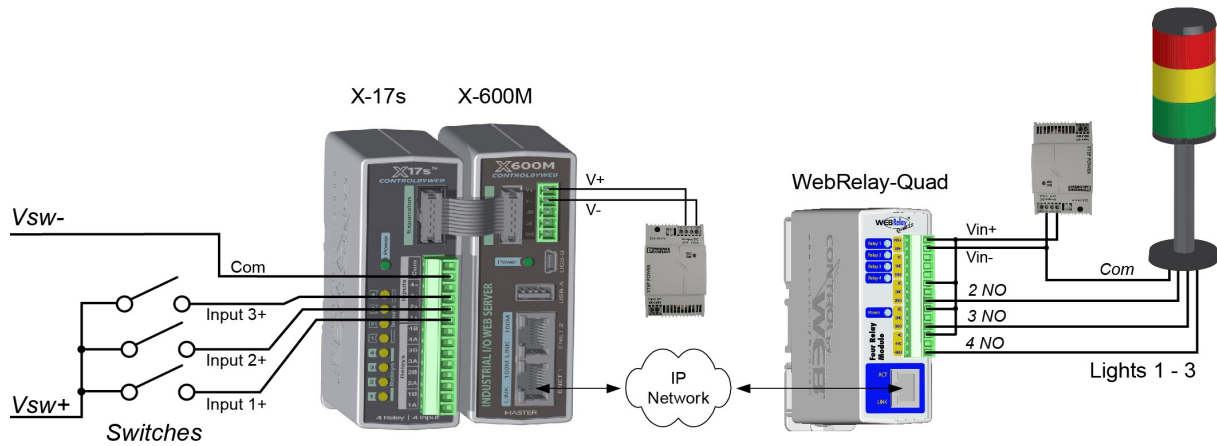

This type of setup allows for switches to be placed far away from the devices they control, and sensors to sound alarms at distant locations.

Note: For dry contact switches, a voltage source must be provided (this could be via the power supply for the X-600M).

3.5 Control a device over an IP network

The illustration below shows a simple example of using the X-17s to control a device over an IP network. The device to be controlled is wired in series with the relay contacts.

Note: A fuse or circuit breaker is shown to limit current overload.

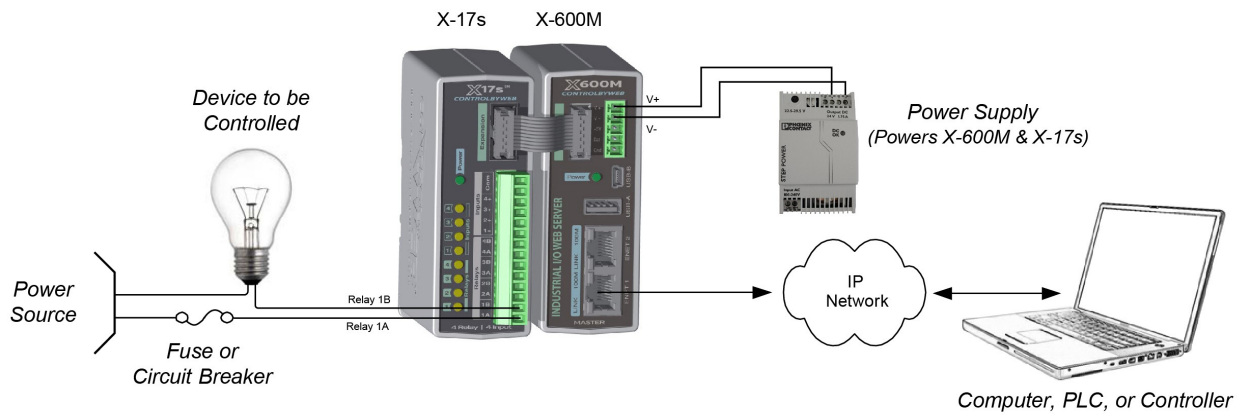

3.6 High Current Relay

The illustration below shows an example of how the X-17s is used to control an AC motor. A high-current relay is used to switch the load current to the motor. In this example a MOV (Metal Oxide Varistor) is used to help protect the relay contacts of the X-17s from arc damage. Under normal conditions the resistance of the MOV is very high. When a spike or surge occurs the resistance of the MOV drops and shunts the high voltage transients.

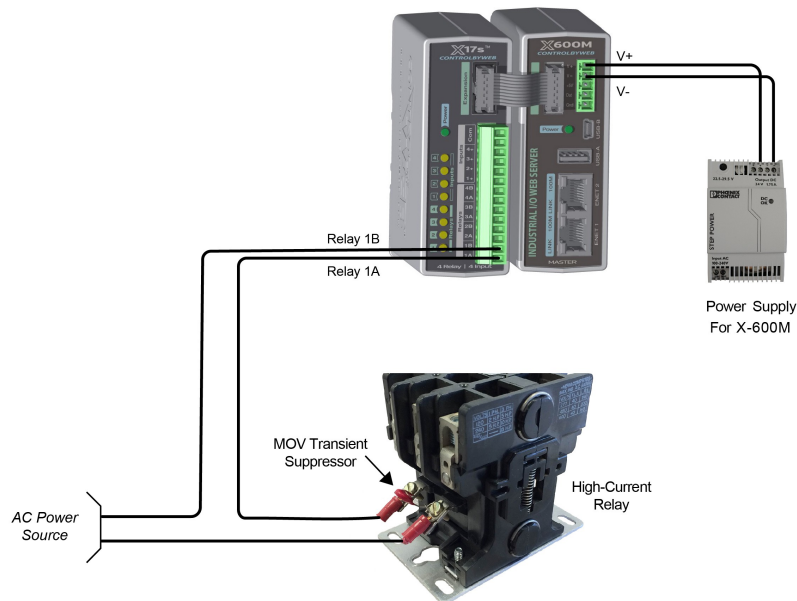

Section 4: Configuration and Setup

4.1 Setup Example

The Quick Start Demo

After making the power and Ethernet connections, the X-600M can automatically scan for the presence of any ControlByWeb™ Ethernet devices (on the same sub-net) and also for any expansion modules connected to the X-600M via the ribbon-cable connector. It also automatically creates a dashboard web page and populates it with all of the resources (components) supported by the Ethernet devices and expansion modules. This makes it easy to start experimenting with the web page's user interface and to try out the relays and sensors.

To quickly add a device do the following:

1. Click on the **Devices** menu tab to pull up the *Devices Overview* page. Then click on the **Find New Devices** button to scan the expansion bus and the local network for ControlByWeb devices and expansion modules.

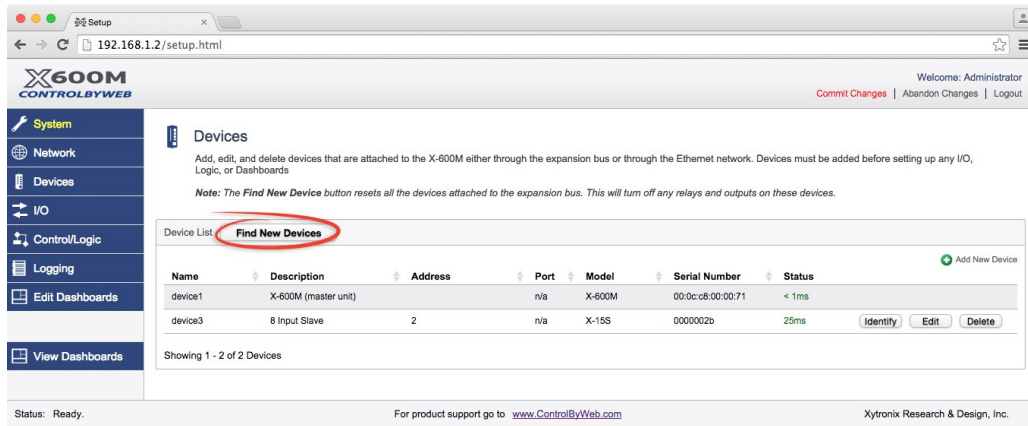

2. In this example we are going to add an X-17s 8 expansion module. Click the **Add** button for the X-17s.

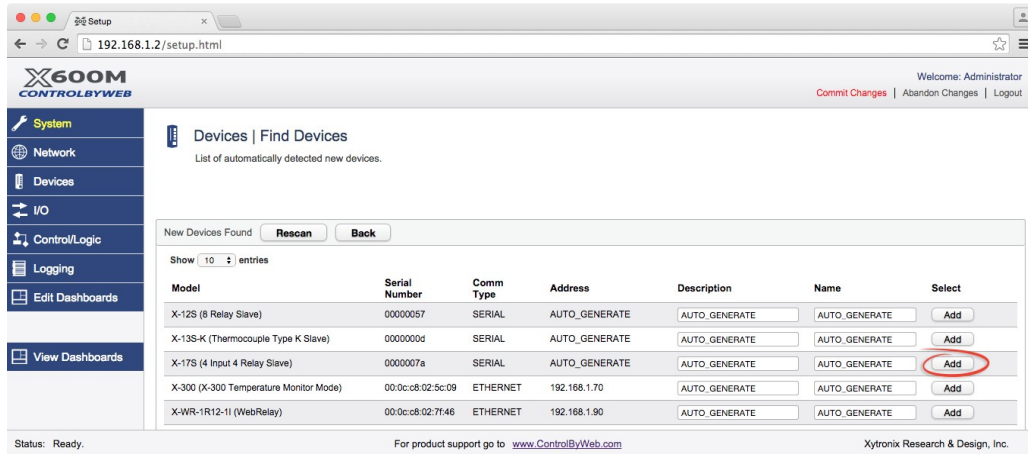

3. In the *Select* column, click the checkboxes of the I/O components you would like to configure and select the **Create Device Widget** checkbox (This will display the status of the I/O on the Dashboard).

Click **Add Checked I/O** to submit these changes.

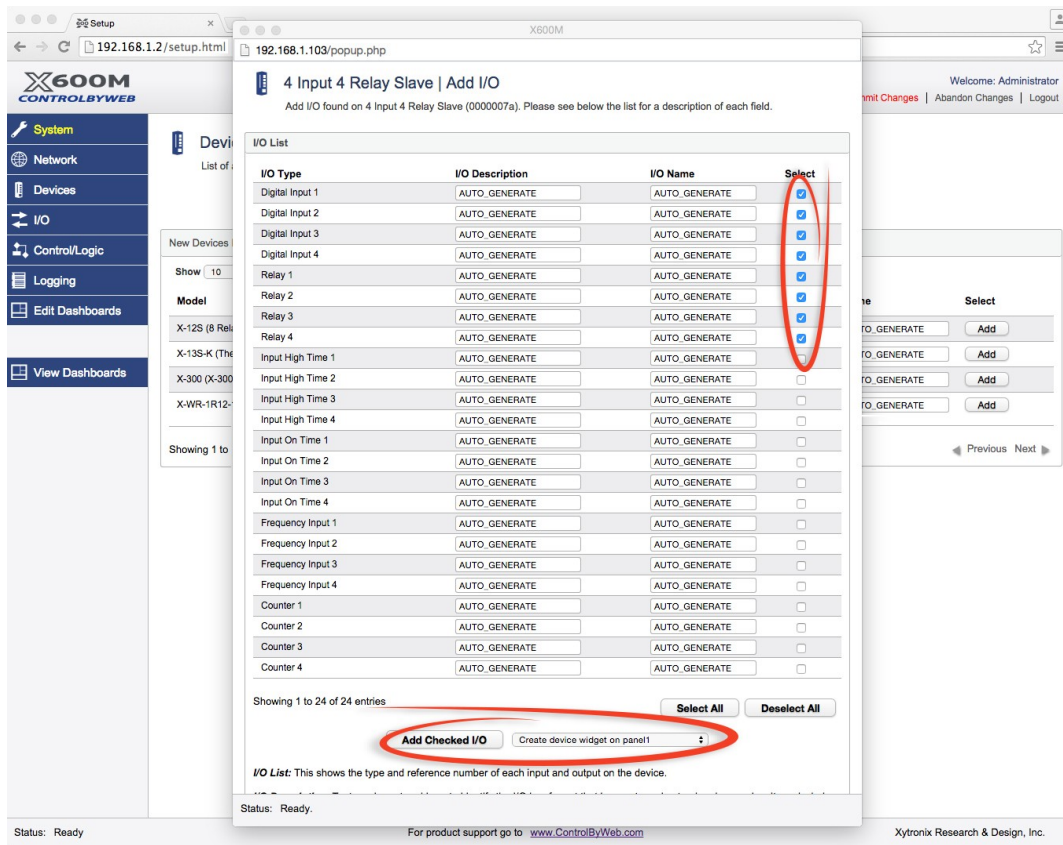

4. Click **Commit Settings** - Once clicked, the X-600M begins to monitor the newly added device.

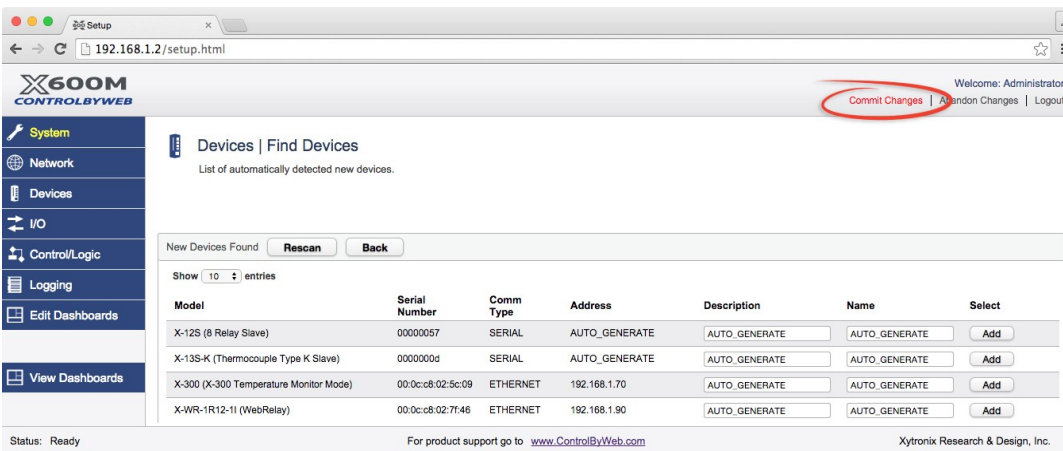

5. On the main menu, click the **View Dashboards** menu tab. The **View Dashboards** page shows a display similar to what users will see when accessing the X-600M's control page. The status for each of the relays and inputs should be shown. Use this page to test and debug the dashboards, panels, widgets and components in real time. A pull-down menu allows access to other dashboards. Within minutes you can experience the power and flexibility of the dashboard's user interface and experiment/test the buttons, sliders, and data entry boxes to meet your needs for your specific application.

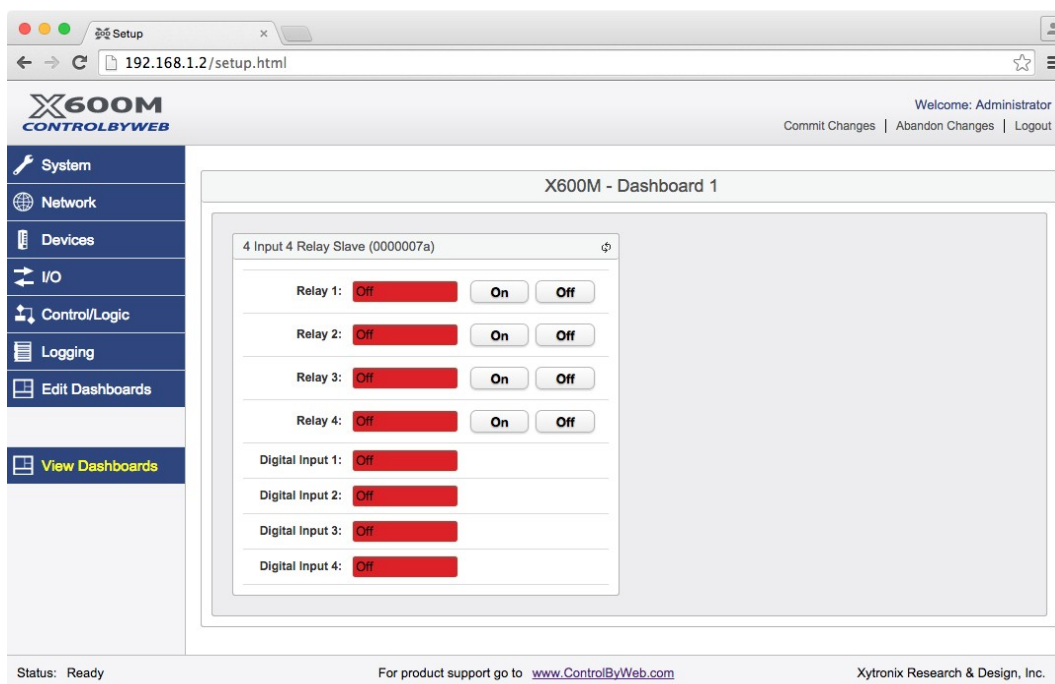

Appendix A: Specifications

Power Requirements

Input Voltage: 9-28 VDC (power is supplied via the expansion bus cable, 24V recommended)
 Current: See table below for typical values at 25°C

Power Supply	Opto-couplers & Relays OFF	Opto-couplers & Relays ON
9 VDC	18 mA	224 mA
12 VDC	14 mA	165 mA
24 VDC	8 mA	86 mA

Digital Inputs

Number of Inputs: 4
 Minimum Pulse Time (high or low): 2.5mS
 Input Current (Iin): 950uA @ 4V, 8.5mA @ 26V
 Isolation (Viso): 3,000 Vrms
 Reverse voltage (Vr): 6V max
 Vin: 26V (max)
 Vin Hi: 4V (min)
 Vin Lo: 3V (max)

Digital Input Measurement Functions

Input State: Asynchronous status of the digital inputs
 High Time: Pulse width (4,194,304 seconds max)
 On Time: Accumulated time an input is asserted (4,194,304 seconds max)
 Count: Total number of transitions (32-bit)
 Frequency: 1 Hz min, 200 Hz max
 Edge Trigger: Rising, Falling or Both
 De-bounce Time: 0.9mS min, 63 sec max

Relay Contacts

Number of relays: 4
 Load Type: General purpose
 Contact Form: SPST (1 form A)
 Contact Material: Silver nickel
 Max Voltage: 125VAC, 30VDC
 Max Current: 2.5A
 Electrical Life: 100K cycles, typical @ rated load
 Environmental Rating: Over voltage Category II, Pollution Degree 2

Control Options: On/Off or Pulsed
 Pulse Timer Duration: 100ms to 86400 Seconds (1-day)

Connector

Type:	14-position, removable, 3.81 mm pitch
Connection wire:	Use wire rated for 75°C (min) for connections to the terminal blocks
Stripping Length:	7mm
Connection capacity:	1.5mm ² stranded, 1.5mm ² solid
Conductor minimum:	30AWG (UL/CUL)
Conductor maximum:	14 AWG (UL/CUL)
Conductor Type:	Copper
Tightening torque:	0.22 Nm (min), 0.25 Nm (max)

(Replacement part number, Phoenix Contact 1803691)

Expansion Connector:

Connector:	Ribbon cable, 2x5-position, polarized 0.100" pitch
Communications:	RS-485

LED Indicators

Green:	Power On
Yellow:	Input 1 thru 4, Relay 1 thru 4

Environmental

Rating:	Indoor use or NEMA-4 protected location
Altitude:	up to 2000m
Operating Temperature:	-40°C to 65.5°C (-40°F to 150°F)
Storage Temperature:	-40°C to 85°C (-40°F to 185°F)
Humidity:	5-95%, non-condensing

Mechanical

Size:	1.41 x 3.88 x 3.1 in. (35.7 x 98.5 x 78 mm), (not including connector)
Weight:	4.8 oz (136 g)

Electromagnetic Compliance

IEC CISPR 22, CISPR 24
FCC 47CFR15 (Class B)
EN55024 ITE Immunity (2010)
EN55022 Emissions (2010)

Product Safety Compliance

UL 61010-1



Appendix B: Trademark and Copyright Information

This document is Copyright ©2015 by Xytronix Research & Design, Inc. All rights reserved.

X-600M™, WebRelay™, ControlByWeb™, and Xytronix Research & Design™ are trademarks of Xytronix Research & Design™, Inc. 2005-2015.

All other trademarks are the property of their respective owners.

All parts of this product and design including but not limited to firmware, hardware design, schematics, PCB layout, concept, graphics, users manual, etc., are property of Xytronix Research & Design, Inc. ©2005-2015. X-600M may not be opened, disassembled, copied or reverse-engineered.

No part of this manual may be reproduced or transmitted in any form or by any means, electronic or mechanical, including photocopying or scanning, for any purpose other than the personal use by the purchaser of this product. Xytronix Research & Design, Inc., assumes no responsibility for any errors that may appear in this document.

Whereas reasonable effort has been made to make the information in this document as useful and accurate as possible, Xytronix Research & Design, Inc. assumes no responsibility for the application, usefulness, or completeness of the information contained herein. Under no circumstance will Xytronix Research & Design, Inc. be responsible or liable for any damages or losses including direct, indirect, special, incidental, or consequential damages or losses arising from either the use of any information contained within this manual or the use of any products or services referenced in this manual.

Xytronix Research & Design, Inc. reserves the right to change any product's features, specifications, documentation, warranties, fee schedules, and conditions at any time and without notice.

Appendix C: Warranty

This Xytronix Research & Design, Inc. product has a warranty against defects in material and workmanship for a period of one year from the date of shipment. During the warranty period, Xytronix Research & Design, Inc. will, at its option, either repair or replace products that prove to be defective. This warranty is extended to the original purchaser of the equipment only.

For warranty service or repair, the product must be properly packaged, and returned to Xytronix Research & Design, Inc. The purchaser shall prepay all charges for shipping to Xytronix Research & Design, Inc., and Xytronix Research & Design, Inc. will pay the shipping charges to return the product to the purchaser as long as the product is shipped within the United States. If the product is shipped outside of the United States, the purchaser shall pay all shipping charges, duties, and taxes.

Limitation

The foregoing warranty shall not apply to defects or damage resulting from improper use or misuse, unauthorized repair, tampering, modification, improper connection, or operation outside the electrical/environmental specifications for the product. Further, the warranty does not cover Acts of God, such as fire, flood, hurricanes, and tornadoes. This warranty does not cover damage to property, equipment, direct, indirect, consequential, or incidental damage (including damage for loss of business profit, business interruption, loss of data, and the like) arising out of the use or misuse of this product.

UNDER NO CIRCUMSTANCES WILL THE LIABILITY OF XYTRONIX RESEARCH & DESIGN, INC. TO THE PURCHASER OR ANY OTHER PARTY EXCEED THE ORIGINAL PURCHASE PRICE OF THE PRODUCT, REGARDLESS OF THE FORM OF THE CLAIM. No other warranty is expressed or implied. Xytronix Research & Design, Inc. specifically disclaims the implied warranties or merchantability and fitness for a particular purpose. Some jurisdictions may not allow the exclusion of limitation of liability for consequential or incidental damage.

Appendix D: FCC Statement

This device complies with Part 15 of the FCC Rules. Operation is subject to the following two conditions:

- This device may not cause harmful interference.
- This device must accept any interference received, including interference that may cause undesired operation.

Warning

This equipment has been tested and found to comply with the limits for a Class B digital device, pursuant to Part 15 of the FCC Rules. These limits are designed to provide reasonable protection. This equipment generates, uses and can radiate radio frequency energy and, if not installed and used in accordance with the instructions, may cause interference to radio communications. There is no guarantee, however, that interference will not occur in a particular installation. If this equipment does cause harmful interference to radio or television reception, which can be determined by turning the equipment off and on, the user is encouraged to try to correct the interference by one or more of the following measures:

- Reorient or relocate the receiving antenna.
- Increase the separation between the equipment and receiver.
- Connect the equipment into a relay on a circuit different from where the receiver is connected.
- Consult the dealer or an experienced radio/TV technician for help.

Notice

Changes or modification not expressly approved by the party responsible for compliance could void the user's authority to operate the equipment.

