



bryton®



Rider  
20

User's Manual





## Table of Contents

<b>Getting Started.....</b>	<b>4</b>	<b>View Exercise/Training Record .....</b>	<b>17</b>
Your Rider 20 .....	4	Clear Storage.....	18
Reset Rider 20.....	5	<b>Other Settings.....</b>	<b>19</b>
Accessories .....	5	Using Stopwatch .....	19
Status Icons .....	5	Time Settings.....	20
Connect, Sync, and Charge.....	6	Auto Calibration by GPS.....	20
Turn On/Off Rider 20.....	6	Set Daylight Saving Time .....	21
Initial Setup .....	6	Auto Scrolling.....	21
Ride Your Bike with Rider 20! .....	7	Turn GPS On/Off .....	22
Manage Rider 20 Data via Your Computer .....	7	Set Tone .....	22
Share Your Experience With Other Bikers.....	7	<b>Appendix.....</b>	<b>23</b>
<b>Exercise/Training .....</b>	<b>8</b>	Specifications .....	23
Display Information.....	8	Battery Information .....	24
Before You Start .....	9	Install Rider 20 .....	25
Start/Pause/Stop Exercising.....	9	Mount Rider 20 to the Bike .....	25
Mark Lap .....	10	Install the Speed/Cadence Sensor (Optional) .....	26
View Exercise/Training Info .....	10	Install Heart Rate Belt (Optional).....	27
Changing Modes .....	11	Wheel Size and Circumference .....	28
<b>Training Settings .....</b>	<b>12</b>	Screen Terminologies .....	29
Set Training.....	12	Basic Care For Your Rider 20.....	29
By Time .....	12		
By Distance .....	13		
Set LAP Training .....	13		
Select Bike .....	14		
Link Sensors .....	15		
View Sensors Information .....	16		



## **WARNING**

Always consult your physician before you begin or modify any training program. Please read the details in Warranty and Safety Information guide in the package.

## **Product Registration**

Help us better support you by completing your device registration using Bryton Bridge. Go to <http://support.brytonsport.com> for more information.

## **Bryton Software**

Go to <http://brytonsport.com> to download free software to upload your personal profile, tracks and analyze your data on the web.

# Getting Started

This section will guide you on the basic preparations before you start using your Rider 20.

## Your Rider 20

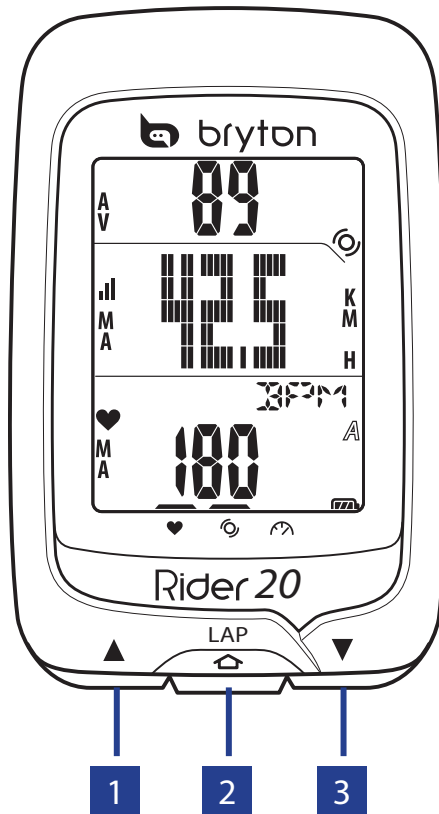

### 1 UP (▲)

- Long press to turn the backlight on/off.
- In meter view, short press to scroll upper screen page options.
- In Menu, short press to move up to scroll through menu options.

### 2 LAP (LAP)

- To turn off the device, short press to enter Menu and select "OFF (OFF)".
- Short press to access/leave menu.
- When riding and recording, short press to mark the lap.
- In Menu, short press to enter or confirm a selection.

### 3 DOWN (▼)

- In meter view, short press to scroll lower screen page options.
- In Menu, short press to move down to scroll through menu options.

# Reset Rider 20

To reset the Rider 20, long press all three keys (**▲/LAP/▼**) at the same time.

## Accessories









The Rider 20 comes with the following accessories:

- USB cable
- Bike mount

*Optional items:*

- Heart rate belt
- Speed/Cadence sensor
- Combo sensor

## Status Icons

Icon	Item	Solid icon	Flashing icon
	Bike icon	Bike 1	-
		Bike 2	-
	Battery icon	Battery level	Battery charging
		-	Battery low
	GPS icon	GPS signal level	Searching GPS signal
	Record icon	Memory full, must clear storage	Recording in progress
	Heart rate monitor icon	Linked with heart rate monitor	-
	Cadence sensor icon	Linked with cadence sensor	-
	Speed sensor icon	Linked with speed sensor	-

## Connect, Sync, and Charge

### Warning:

This product contains a lithium-ion battery. See the Warranty and Safety Information guide in the package for important battery safety information.

1. Connect Rider 20 to a PC using the supplied USB cable.
2. Download the *Bryton Bridge 2* application at [bb.brytonsport.com](http://bb.brytonsport.com) and sync with Rider 20.



Keep Rider 20 connected to the PC to charge the battery.

Use USB cable to connect to a PC.

**NOTE:** For first time use, charge the battery for at least 3 hours.

## Turn On/Off Rider 20

### To turn on Rider 20:

Short press **LAP** to turn on Rider 20.

### To turn off Rider 20:

1. Short press **LAP** to enter Menu.
2. Short press **▲/▼** to select "**OFF** (OFF)".
3. Short press **LAP** to turn off the device.

**NOTE:** If Rider 20 is left idle for 10 minutes, it will automatically turn off.

## Initial Setup

When turning Rider 20 on for the first time, the setup wizard appears on screen. Follow the instructions to complete setup.

1. Select the display language.
2. Select the unit of measurement.
3. Enter your "user profile".  
(It is recommended to input the data. The data accuracy will highly affect your training analysis.)
4. When **FIND GPS** appears, please go outdoors to acquire GPS signal.  
If not possible to go outdoor, short press **LAP** to cancel acquiring request.

**NOTE:** If you want to change your profile, please connect your device to [Brytonsport.com](http://Brytonsport.com) and change the setting via My Device -> Manage Device Data. Or go to SET > Others > Profile and change your settings.

## Ride Your Bike with Rider 20!

- **Free ride:**

Enjoy the ride with Rider 20 mounted onto your bike.

- **Start an exercise and record your data:**

Short press **LAP** to enter Menu. Choose “**START**” and short press **LAP** to start recording the log.

- **Start a training:**

Short press **LAP** to enter Menu. Choose “**SET > TRAIN**” and short press **LAP** to select from the available training modes: riding time, distance, and LAP.

## Manage Rider 20 Data via Your Computer

1. Connect your Rider 20 to your computer by using USB cable.
2. Install the *Bryton Bridge 2* application. You can download the application at <http://bb.brytonsport.com>.
3. Follow the on-screen instructions to transfer data to your computer.

**NOTE:**

- After unplugging the Rider 20 from the USB, the Rider 20 will reset itself.
- Do not unplug the USB cable during the file transferring process. Otherwise, the files may be damaged or corrupted.

## Share Your Experience With Other Bikers

To share your experiences and training result with other bikers around the world, visit <http://www.brytonsport.com>.



# Exercise/Training

Bicycling is one of the best types of exercise for your body. It helps you to burn your calories, lose weight, and increase your overall fitness. During exercise or training, Rider 20 allows you to measure and record your running activities and displays your current performance.

**NOTE:** Displayed information varies on exercise/training mode and user preference.

## Display Information

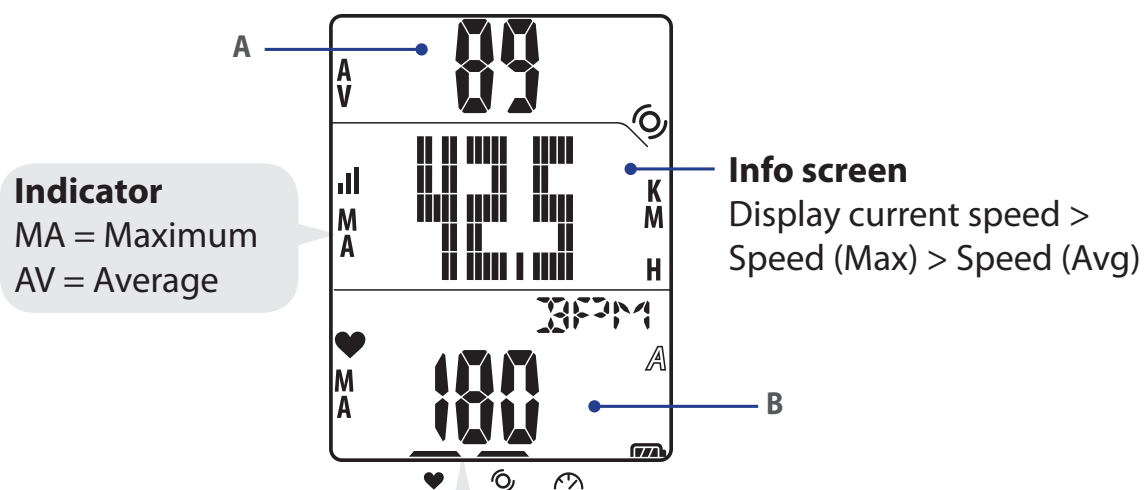

During pairing process (with heart rate monitor/cadence sensor/speed sensor), the LED indicators (on the top of the icons) will blink. When the sensors are successfully linked to the device, the LED indicators will light on.

### Upper screen (A)

Press ▲ to switch information display:

Current time > Ride Time (A or B) > Cadence > Cadence (Avg) > Cadence (Max)

### Lower screen (B)

Press ▼ to switch information display:

Distance > Calories > ODO (A/B) > ODO (A+B) > Total Ride Time (A/B) > Total Ride Time (A+B) > Heart Rate > Heart Rate (Max) > Heart Rate (Avg)

**NOTE:** ODO (A/B), ODO (A+B), Total Ride Time (A/B), and Total Ride Time (A+B) data will only be displayed after you have completed a training/exercise.

The table below provides a graphical indication on using the keys which will be used in later sections.

Keys	Indication
Short press ▲	1 ..... ➔
Short press LAP	2 ==➔
Short press ▼	3 ○○○○○○ ➔
Long press LAP	4 ———➔
*no key press, only display changes	➔

## Before You Start

- Link sensors (page 15), optional

## Start/Pause/Stop Exercising

1. In the main screen, short press **LAP** to enter Menu.
2. Short press ▲/▼ to select **START**.
3. Short press **LAP** to start an activity.
4. To pause an activity, long press **LAP**. Press any key to resume.
5. To end the current activity, short press ▲/▼ to select **STOP** and short press **LAP**.

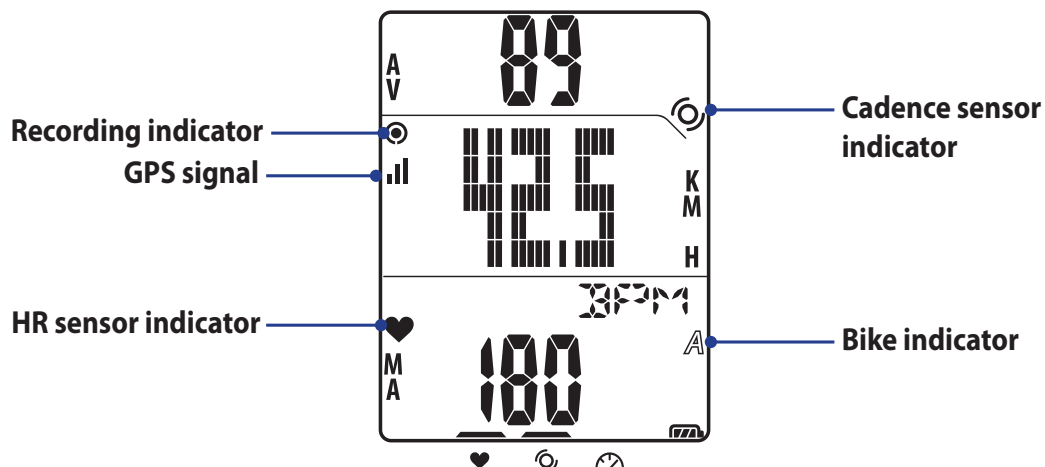

**NOTE:** Please go outdoors to acquire GPS signal when you see "FIND GPS" on the screen.

## Mark Lap

1. Start an activity first.  
See steps 1~3 on "Start/Pause/Stop Exercising" section on the previous page.
2. Short press **LAP** to mark lap.

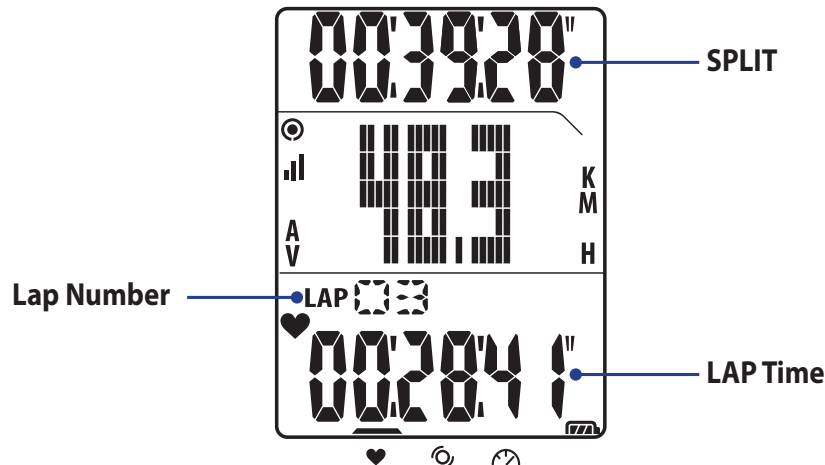

## View Exercise/Training Info

The type of data displayed depends on the current mode and the linked sensors.

Press ▲ to switch information display on the upper screen:

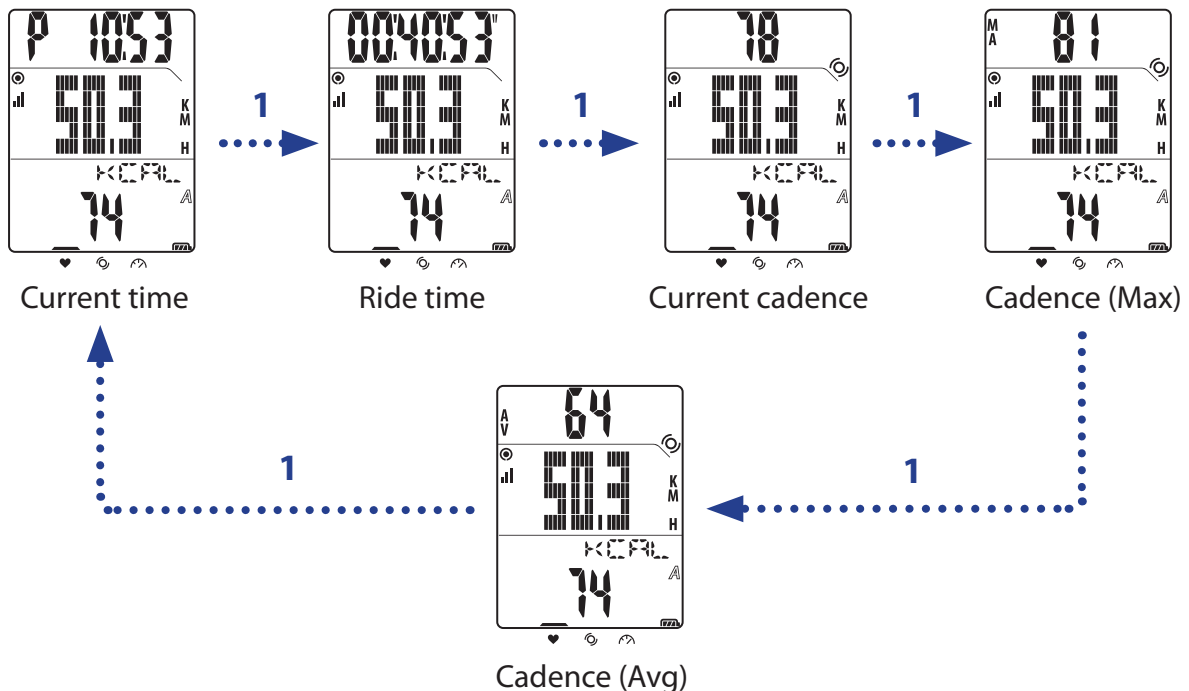

**NOTE:** Cadence data will only be displayed on the screen if cadence sensor is linked to Rider 20.

Press ▼ to switch information display on the lower screen:

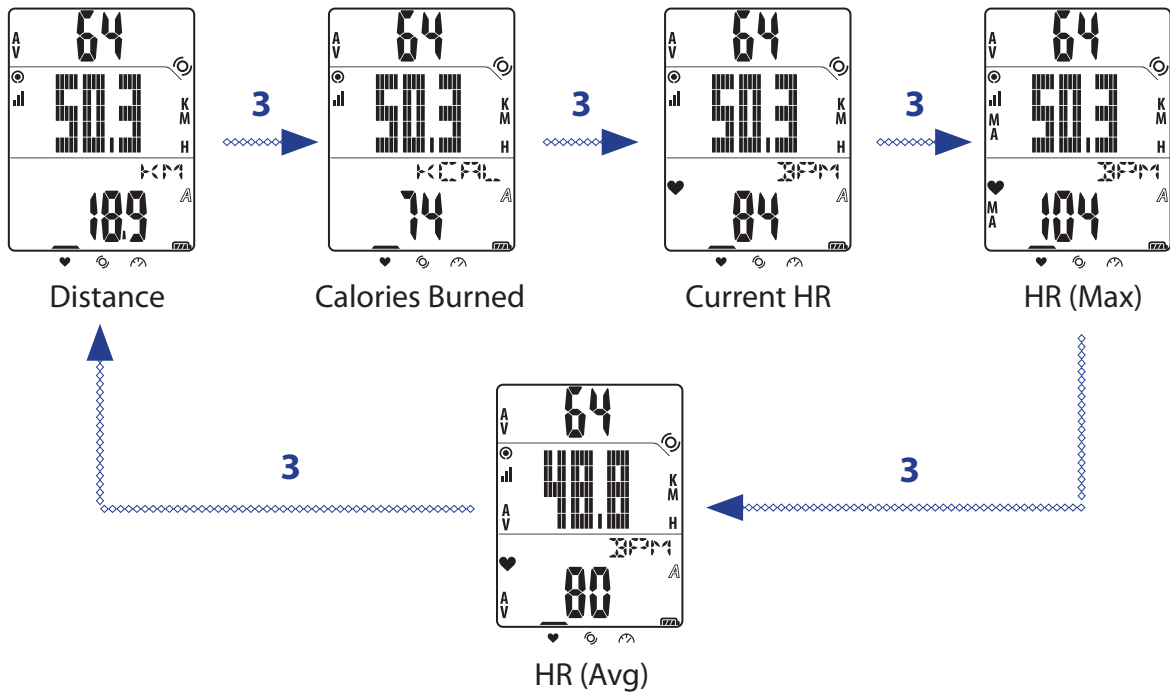

**NOTE:** HR data will only be displayed on the screen if HR sensor is linked to Rider 20.

## Changing Modes

Press the respective key to switch modes.

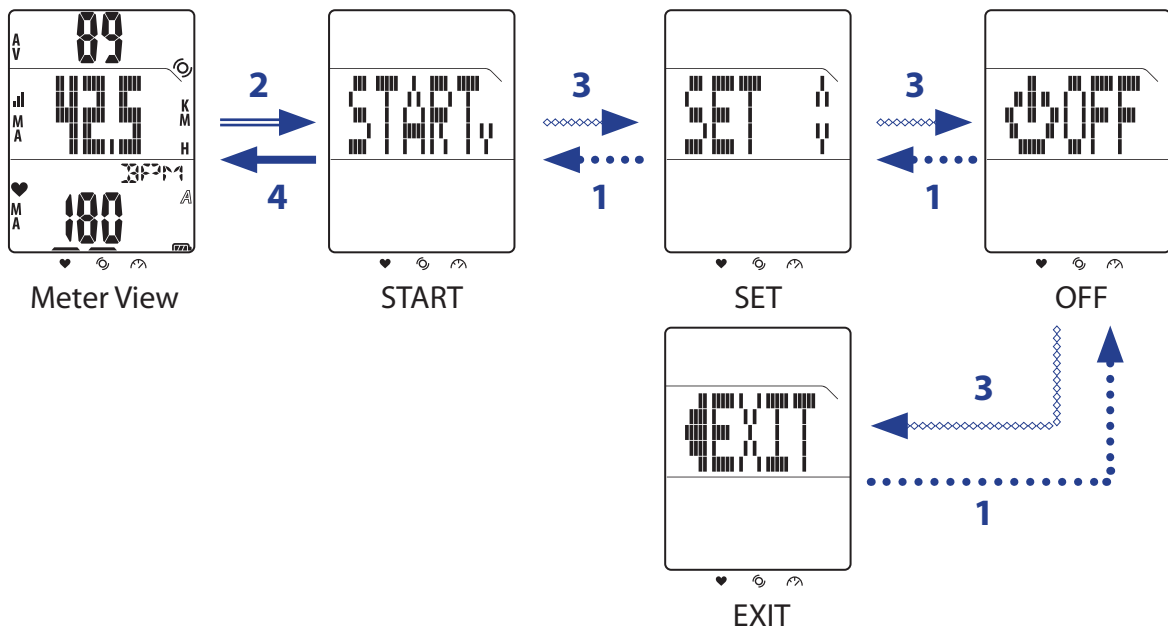

# Training Settings

You can customize the training settings, link the sensors, view history, and other settings.

1. In the main screen, short press **LAP** to enter Menu.
2. Short press **▲/▼** to choose **SET > TRAIN**.
3. Short press **LAP** to set the training settings.

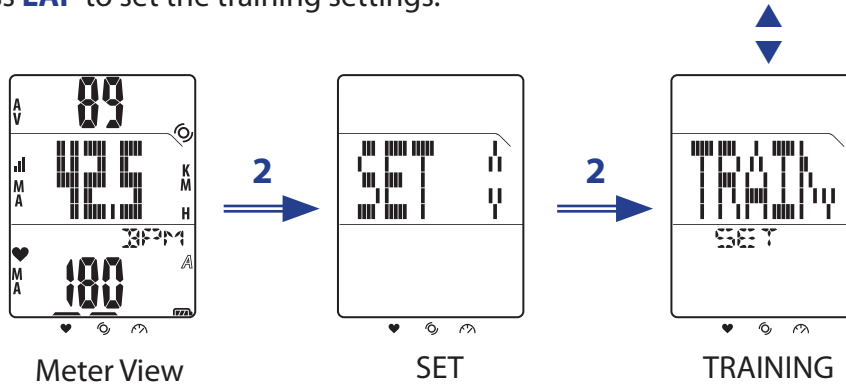

## Set Training

Use the Training setting to select the type of training you want.

The Rider 20 offers you with three types of training modes:

- Riding Time
- Distance
- LAP

## By Time

1. In the Training menu, short press **▲/▼** to select **TIME**.
2. Short press **LAP** to confirm.
3. Short press **▲/▼** to adjust the "hour" value.
4. Short press **LAP** to switch to the "minute" field.
5. Short press **▲/▼** to adjust the "minute" value.
6. Short press **LAP** to confirm and start log for training.

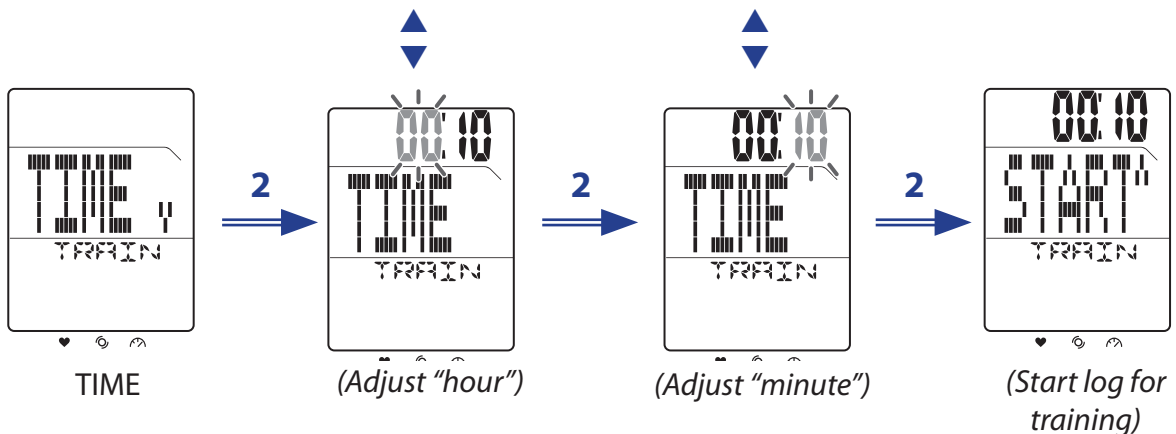

## By Distance

1. In the Training menu, short press ▲/▼ to select **DIST**.
2. Short press **LAP** to confirm.
3. Short press ▲/▼ to adjust the distance.
4. Short press **LAP** to confirm and start log for training.

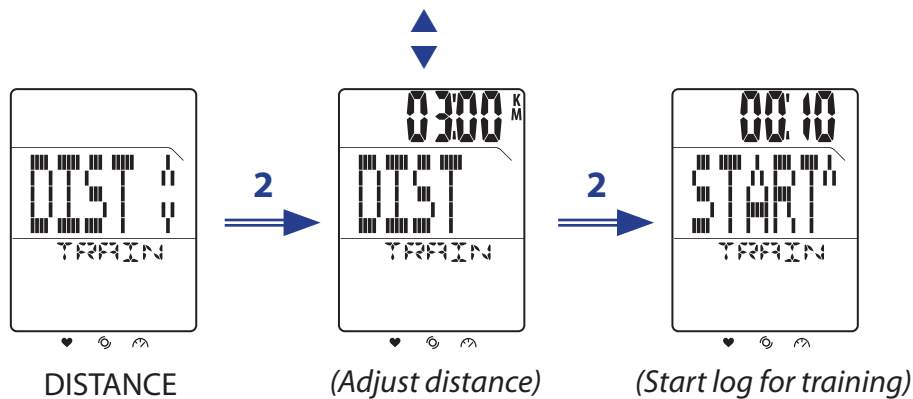

## Set LAP Training

Use Lap by Distance to specify the distance of each lap. After running a specified distance, Rider 20 will automatically mark the lap.

1. In the Training menu, short press ▲/▼ to select **LAP > DIST**.
2. Short press **LAP** to set the Lap by Distance training settings.
3. Short press ▲/▼ to adjust the distance.
4. Short press **LAP** to confirm and start log for training.



Use Lap by Location setting to set your current location as the lap point. Upon reaching the lap point, Rider 20 will automatically mark the lap.

1. In the Training menu, short press ▲/▼ to select **LAP > LOCT**.
2. Short press **LAP** to confirm and start log for training.

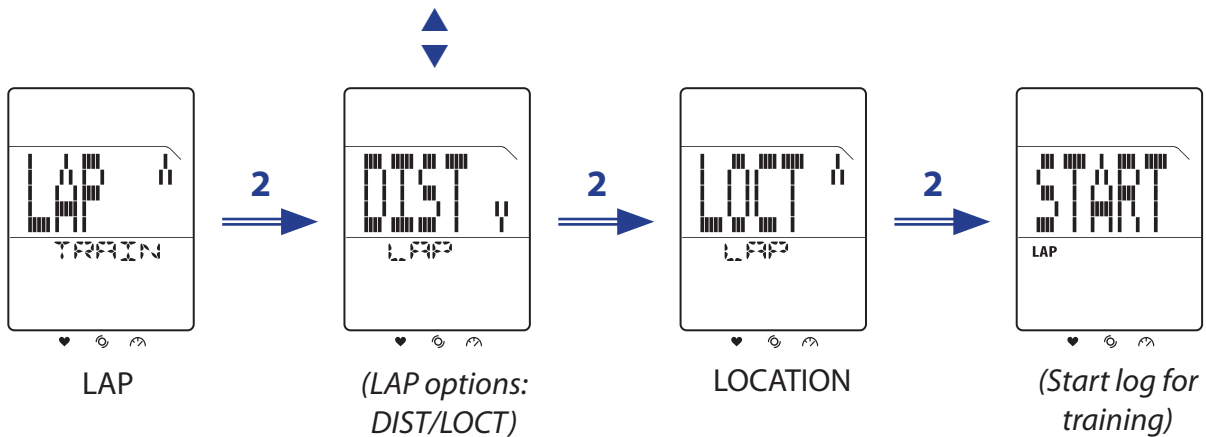

**NOTE:** This option is only available when Rider 20 acquires the GPS signal.

## Select Bike

With Rider 20, you can select the specific bike that you want to ride during exercise.

1. In the main screen, short press **LAP** to enter Menu.
2. Short press ▲/▼ to choose **SET > BIKE**.
3. Short press **LAP** to confirm.
4. Short press ▲/▼ to select the bike.
5. Short press **LAP** to confirm the setting.

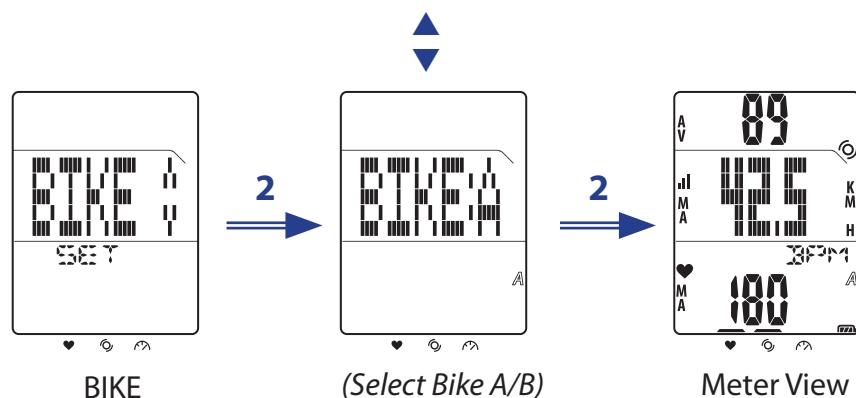

# Link Sensors

Use the Link setting to pair sensors and other optional accessories to Rider 20.

1. In the main screen, short press **LAP** to enter Menu.
2. Short press **▲/▼** to choose **SET > LINK > SCAN**.
3. Short press **LAP** to start scanning the available sensors.

**NOTE:** Make sure the "5 digits" shown on the screen are matched with the last 5 digits of sensor ID number on the plastic bag.

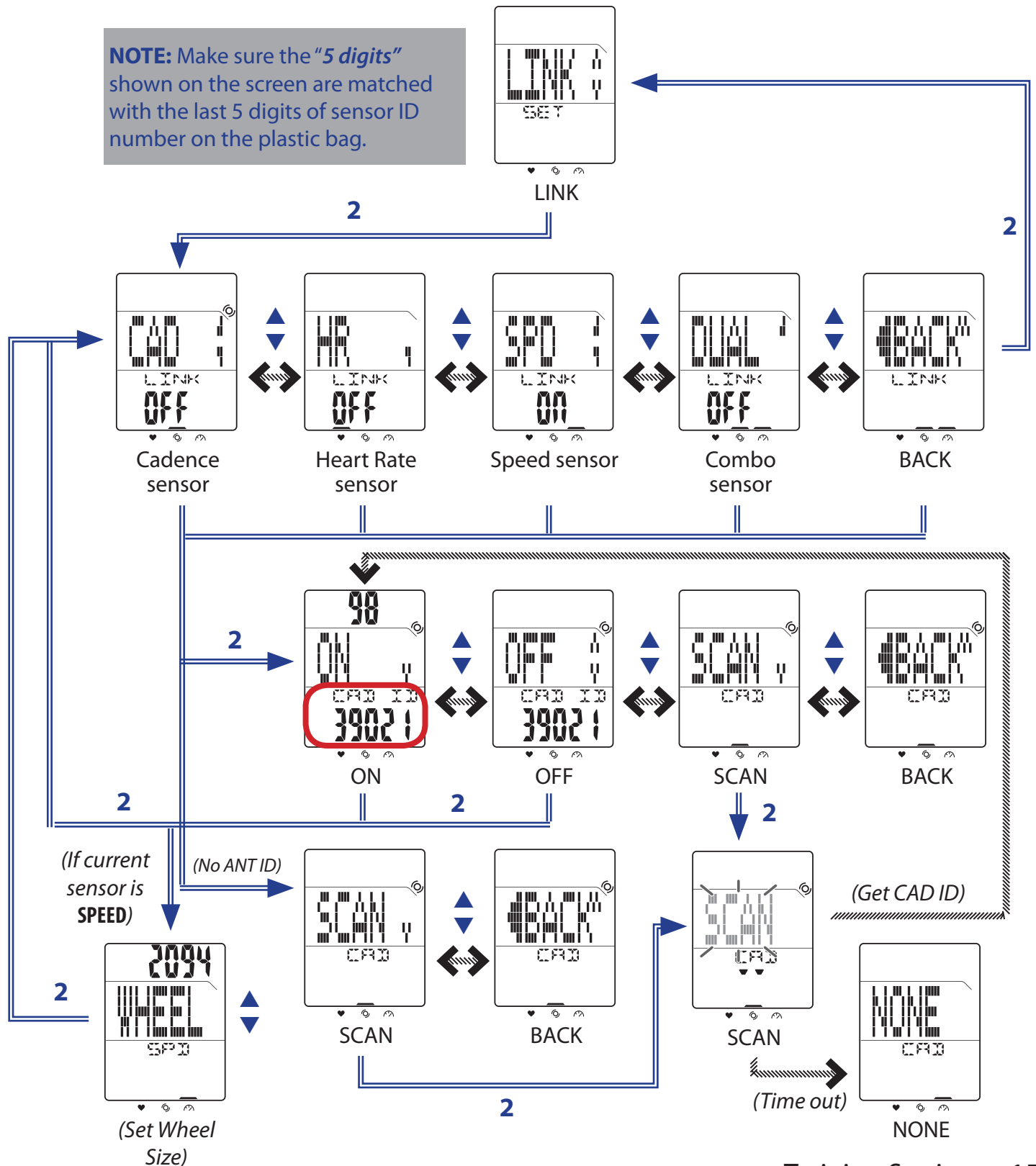



**NOTE:**

- When the sensors are successfully connected, the LED indicators (on the top of the icons) will blink for 5 seconds.
- Be sure to keep the distance between the similar sensors approximately 30 meters.
- If you see below illustration on the screen, this indicates that there are more than 2 sensors detected. Short press ▲/ ▼ to rescan the sensor.

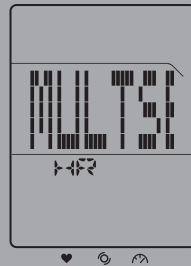

## View Sensors Information

1. In the main screen, short press **LAP** to enter Menu.
2. Short press ▲/▼ to choose **SET > LINK > INFO**.
3. Short press **LAP** to view the linked sensors information.

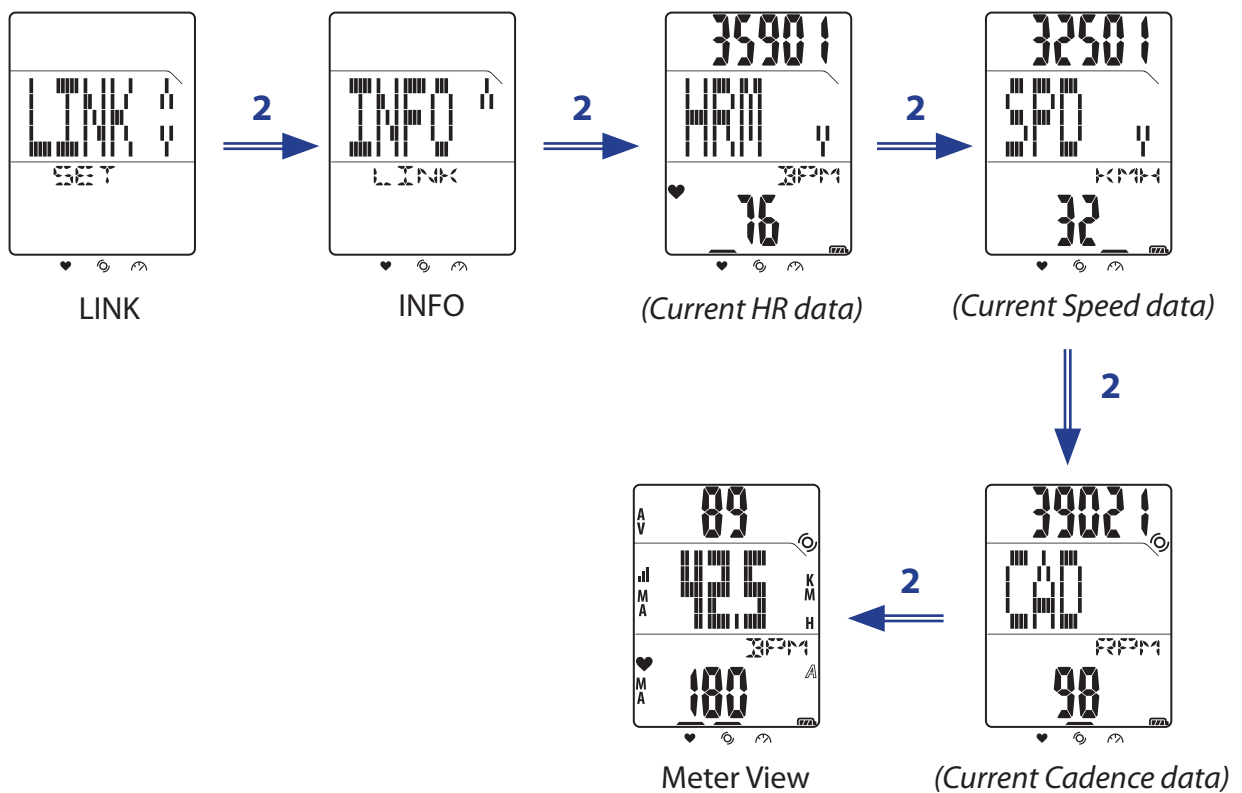

**NOTE:** The sensor ID of the connected sensor is displayed at the upper screen.

# View Exercise/Training Record

Use File to view your training history.

1. In the main screen, short press **LAP** to enter Menu.
2. Short press **▲/▼** to choose **SET > FILE > VIEW**.
3. Short press **LAP** to confirm and view the last history data.

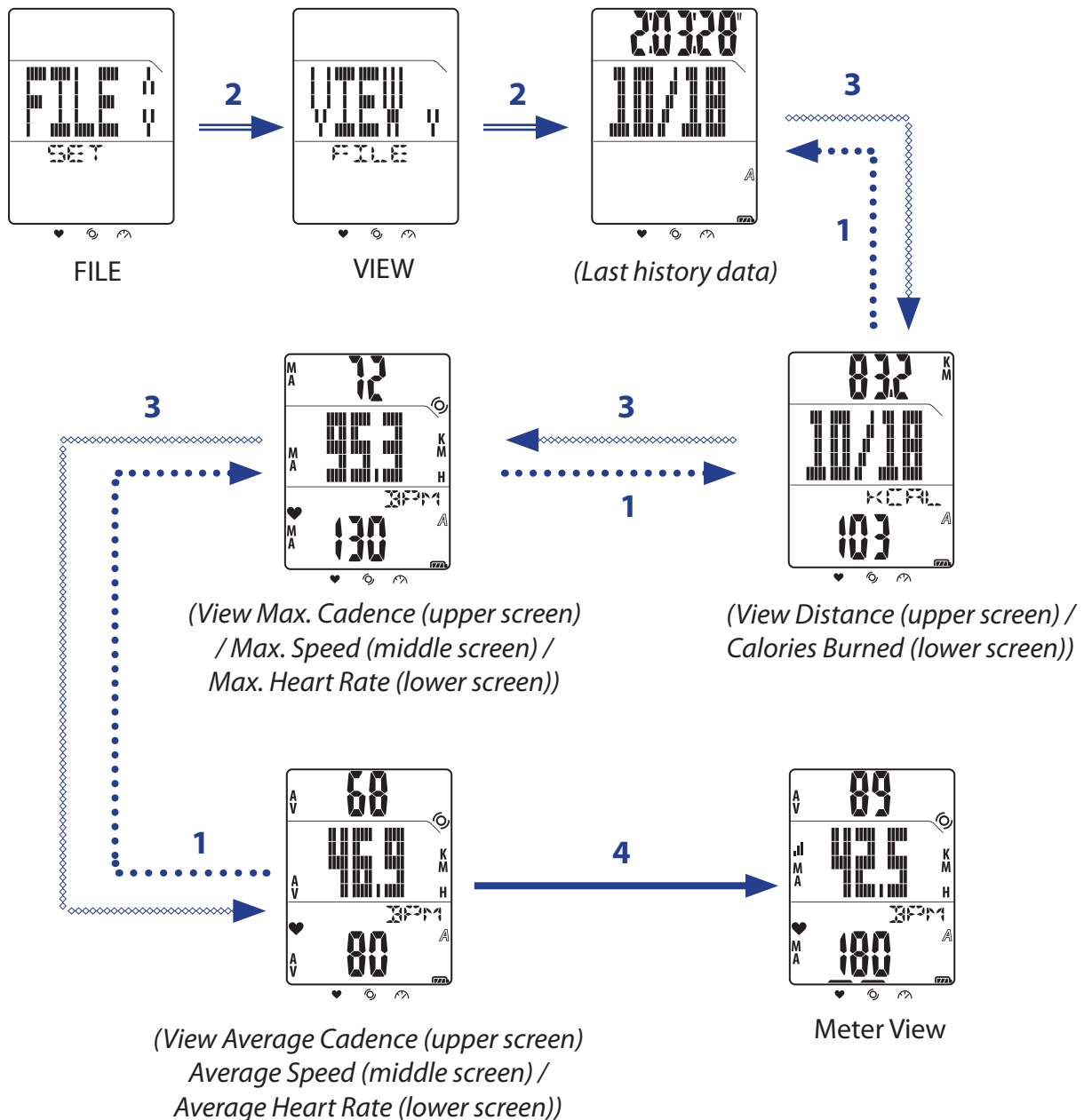

**NOTE:** The total ride time and recorded time are only displayed at the upper/middle screen during the file selection.

## Clear Storage

Use Clear Storage to delete all training and lap records in Rider 20.

1. In the main screen, short press **LAP** to enter Menu.
2. Short press **▲/▼** to choose **SET > FILE > CLS**.
3. Short press **LAP** to confirm.
4. To clear all storage, short press **▲/▼** to choose **YES** and long press **LAP** to confirm all files deletion.

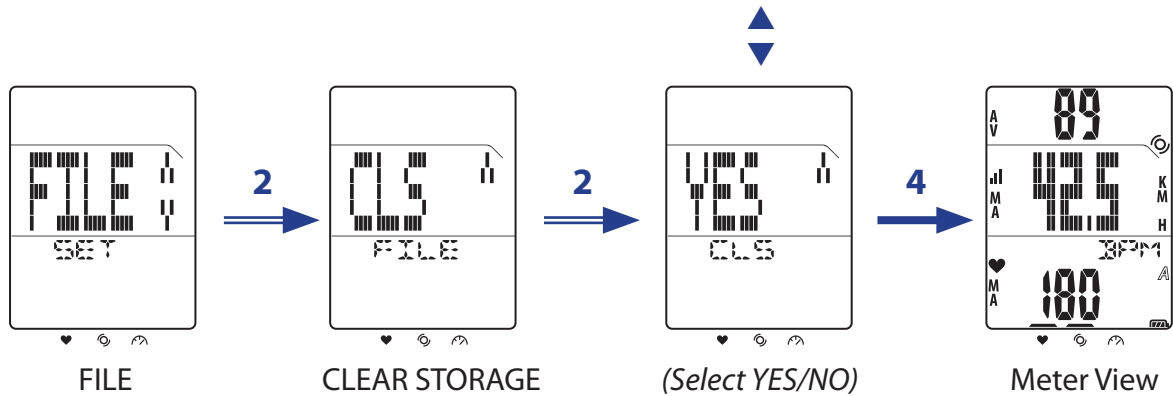

# Other Settings

## Using Stopwatch

You can use Rider 20 as a stopwatch.

1. In the main screen, short press **LAP** to enter Menu.
2. Short press **▲/▼** to choose **SET > OTHERS > STW**.
3. Short press **LAP** to start using stopwatch.

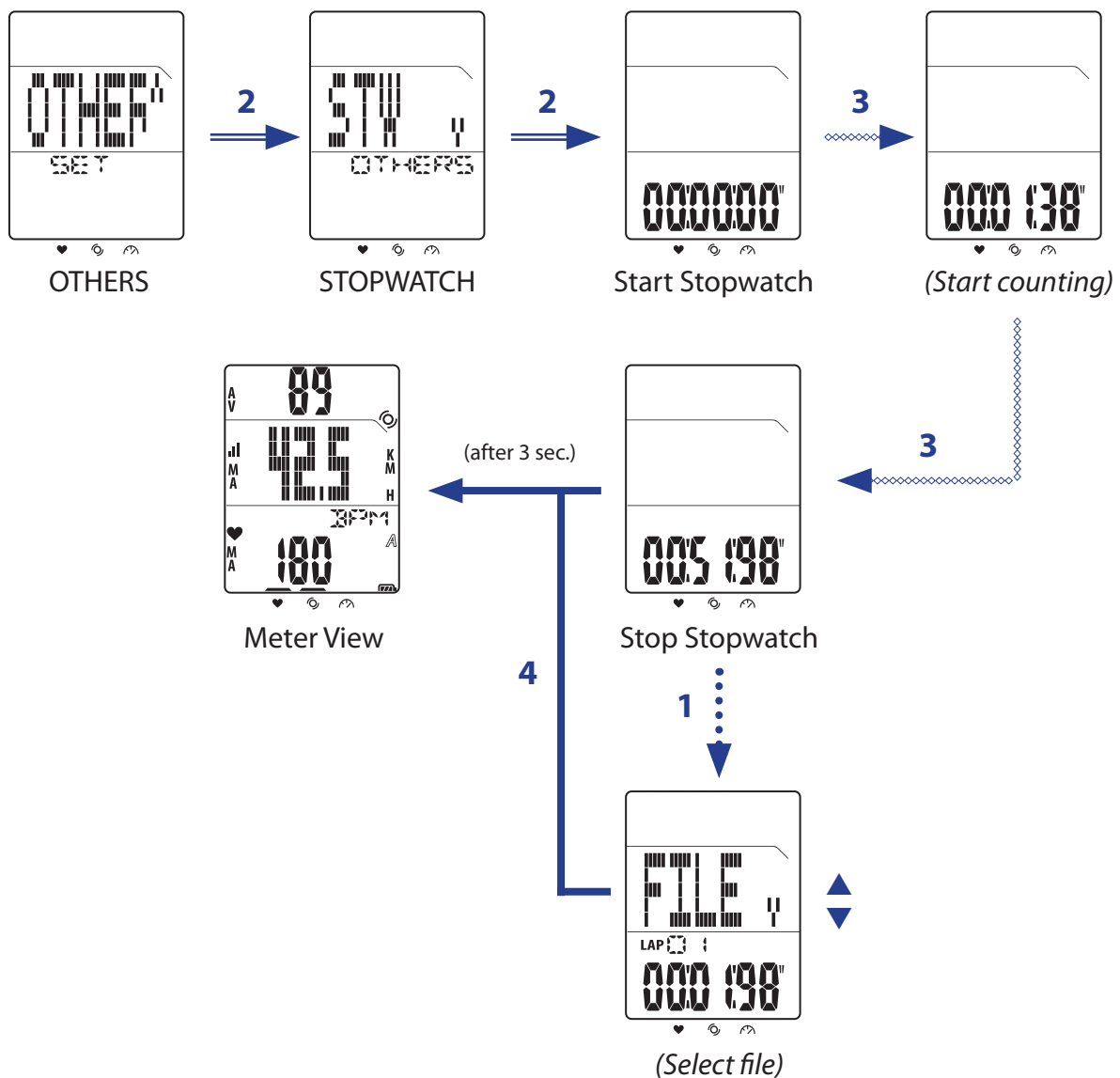

### NOTE:

- While stopwatch is running, short press **LAP** to record lap.
- After stopwatch is stopped, short press **LAP** to reset it or short press **▲** to view files of lap data.

# Time Settings

## Auto Calibration by GPS

Use this setting to reset the date and time based on your GPS location.

1. In the main screen, short press **LAP** to enter Menu.
2. Short press **▲/▼** to choose **SET > TIME > SET TIME**.
3. Short press **LAP** to automatically calibrate the time setting.
4. When "ADJ?" appears on the screen and the displayed time is correct, short press **LAP** to confirm the setting.  
To manually adjust the time, short press **▲/▼** and short press **LAP** to save the changes.
5. Short press **▲/▼** to select the time format and short press **LAP** to confirm.

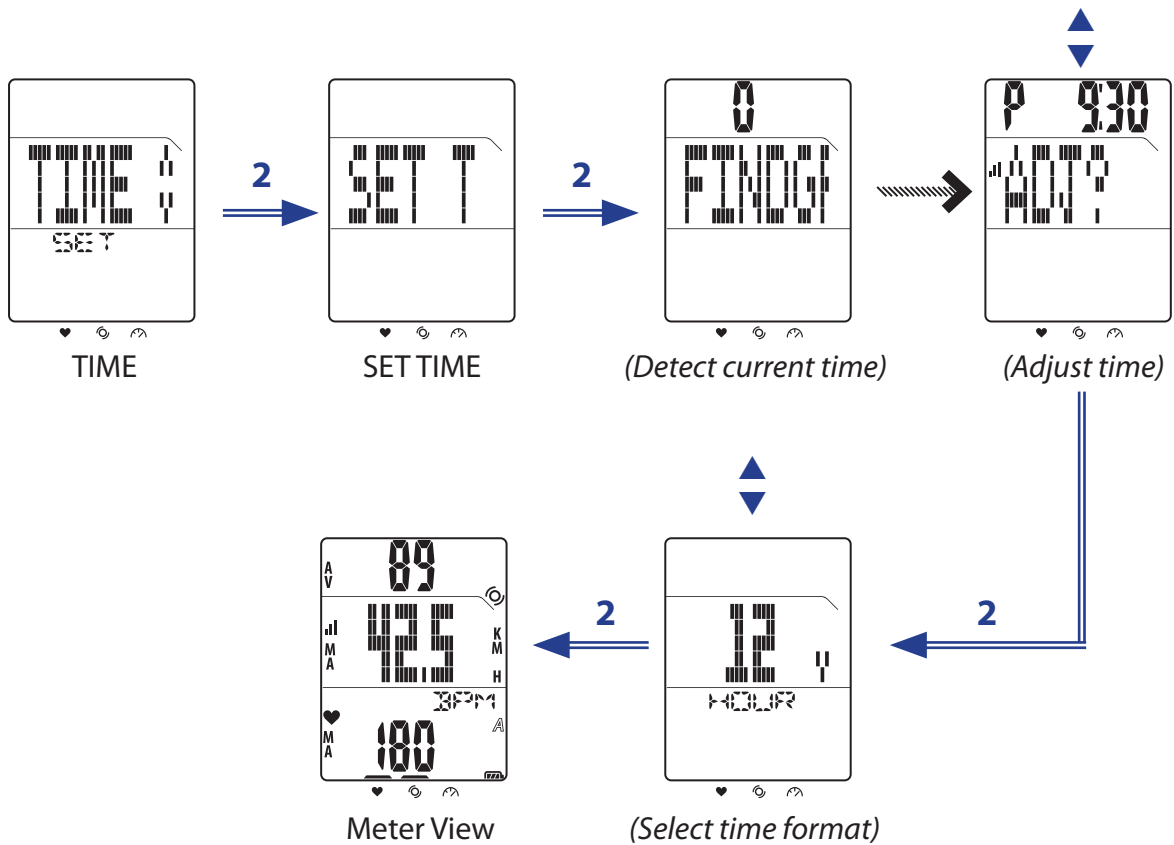

## Set Daylight Saving Time

Use this setting to set the daylight saving time.

1. In the main screen, short press **LAP** to enter Menu.
2. Short press **▲/▼** to choose **SET > TIME > DST**.
3. Short press **LAP** to set the setting.
4. Short press **▲/▼** to set the daylight saving time and short press **LAP** to confirm.

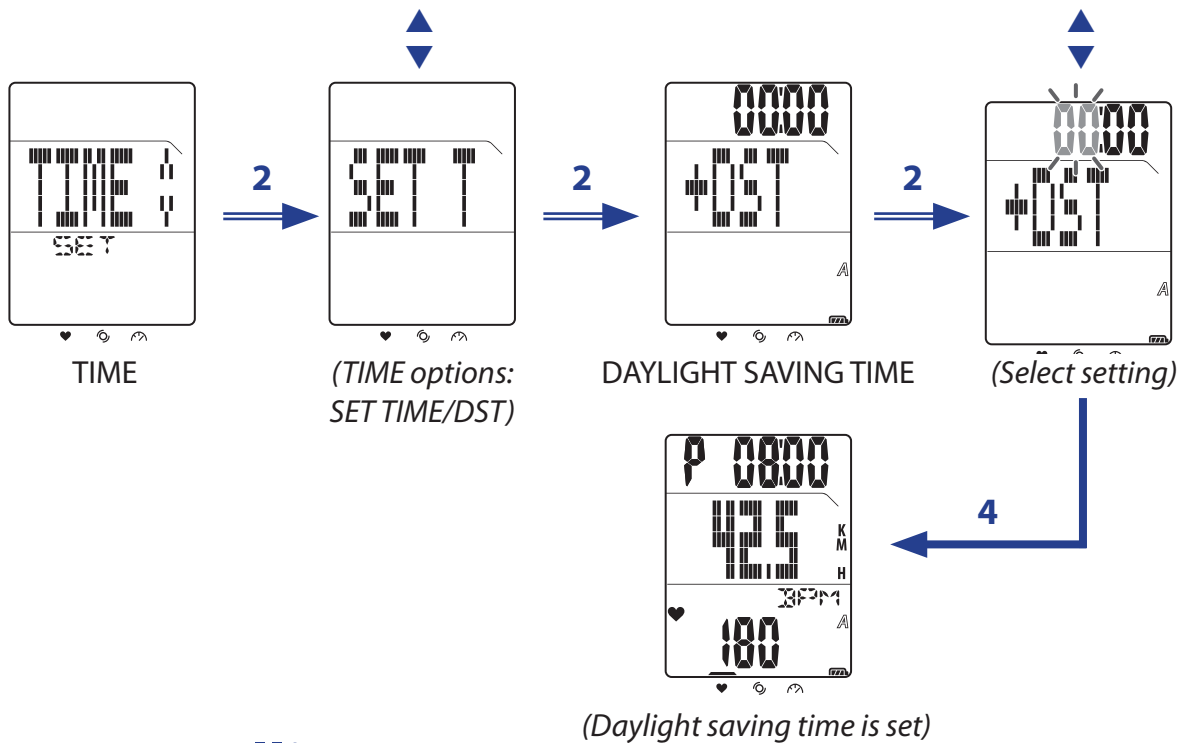

## Auto Scrolling

Use the Auto Scrolling setting to enable or disable the auto scrolling feature. If this feature is enabled, all exercise info will be displayed in sequences without pressing any key while you are doing exercise or training.

1. In the main screen, short press **LAP** to enter Menu.
2. Short press **▲/▼** to choose **SET > SCROLL**.
3. Short press **LAP** to set the setting.
4. To enable Auto Scrolling, short press **▲/▼** to choose **ON** and short press **LAP** to confirm.

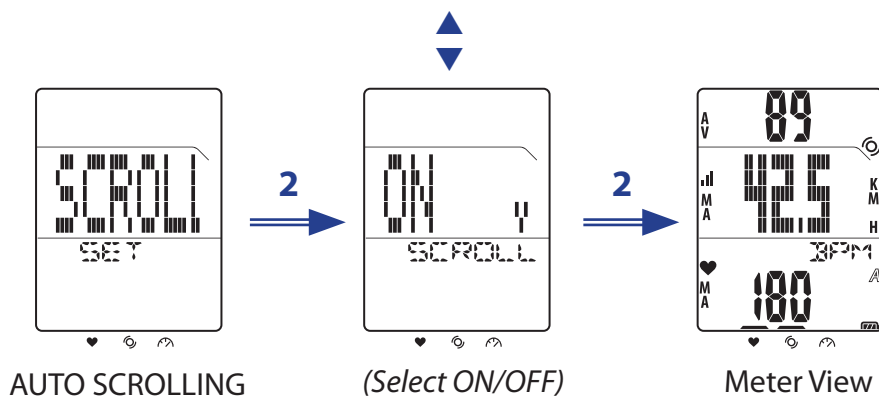

## Turn GPS On/Off

Use the GPS setting to turn GPS on or off.

1. In the main screen, short press **LAP** to enter Menu.
2. Short press **▲/▼** to choose **SET > OTHERS > GPS**.
3. Short press **LAP** to set the GPS setting.
4. To enable GPS, short press **▲/▼** to choose **ON** and short press **LAP** to confirm.

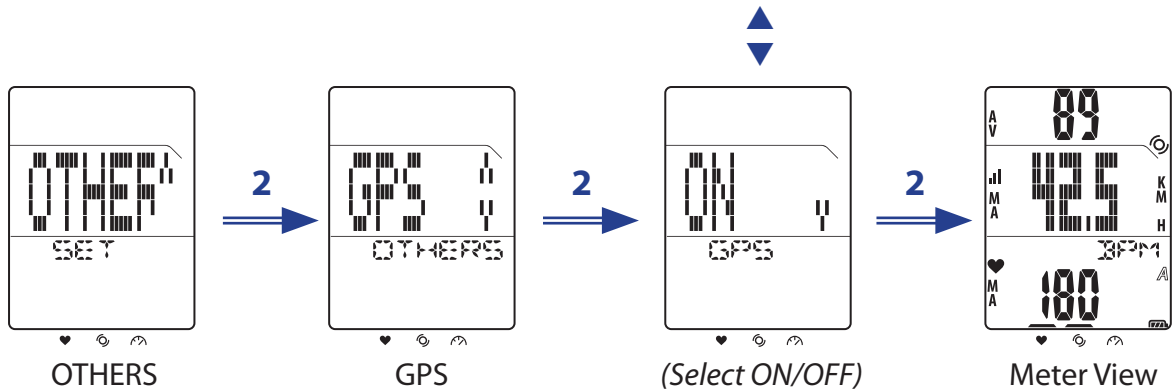

**NOTE:** Rider 20 will automatically acquire the GPS signal if the GPS setting is set to ON. It is highly recommended to go outdoors to acquire GPS signal.

## Set Tone

Use the Tone setting to enable or disable the key tone.

1. In the main screen, short press **LAP** to enter Menu.
2. Short press **▲/▼** to choose **SET > OTHERS > TONE**.
3. Short press **LAP** to set the key tone setting.
4. To enable the key tone, short press **▲/▼** to choose **ON** and short press **LAP** to confirm.

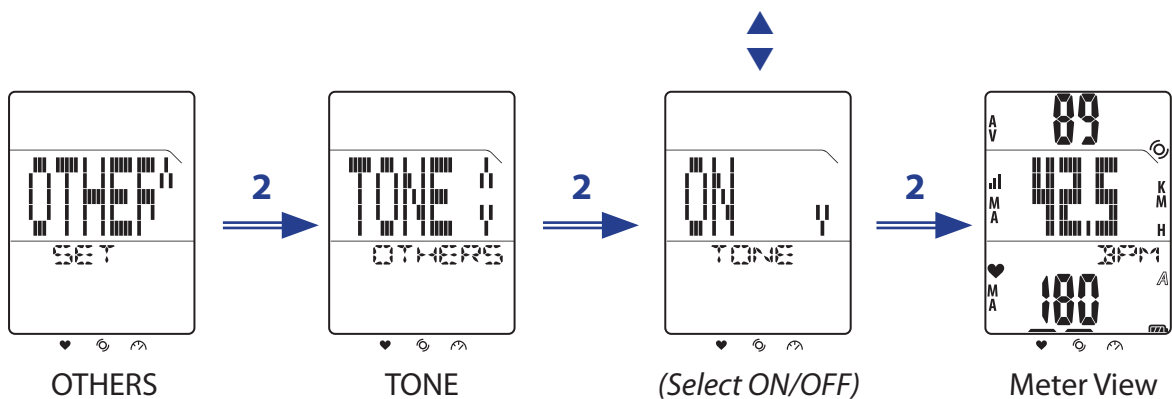

# Appendix

## Specifications

### Rider 20

Item	Description
Display	1.6 TN Positive transfective Segement LCD
Physical Size	39.6 x 58.9 x 17 mm
Weight	40g
Operating Temperature	-10°C ~ 50°C
Battery Charging Temperature	0°C ~ 40°C
Battery	490 mAh rechargeable Li-Polymer
Battery Life	24 hours with GPS on
GPS	Integrated high-sensitivity U-blox receiver with embedded antenna
RF Transceiver	2.4GMHz Ant+
Water Resistant	IPX6 waterproof rating
External Storage	1M Byte

### Speed/Cadence Sensor

Item	Description
Physical size	34.2 x 46.7 x 13.2 mm
Weight	14 g
Water Resistance	IPX7
Transmission range	5 m
Battery life	1 hour per day for 16 months
Operating temperature	-10°C ~ 60°C
Radio frequency/protocol	2.4GHz / Dynastream ANT+ Sport wireless communications protocol

Accuracy may be degraded by poor sensor contact, electrical interference, and receiver distance from the transmitter.



## Heart Rate Monitor

Item	Description
Physical size	67~100 x 26 x 15 mm
Weight	14 g (sensor) / 35g (strap)
Water Resistance	20 m
Transmission range	5 m
Battery life	1 hour per day for 24 months
Operating temperature	5°C ~ 40°C
Radio frequency/protocol	2.4GHz / Dynastream ANT+ Sport wireless communications protocol

Accuracy may be degraded by poor sensor contact, electrical interference, and receiver distance from the transmitter.

## Battery Information

### Heart Rate Monitor and Cadence Sensor Battery

The heart rate monitor/cadence sensor contains a user-replaceable CR2032 battery.

To replace the battery:

1. Locate the circular battery cover on the back of the heart rate monitor/cadence sensor.
2. Use a coin to twist the cover counter-clockwise so the arrow on the cover points to OPEN.
3. Remove the cover and battery. Wait for 30 seconds.
4. Insert the new battery, with the positive connector first into the battery chamber.
5. Use a coin to twist the cover clockwise so the arrow on the cover points to CLOSE.

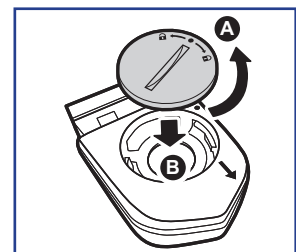
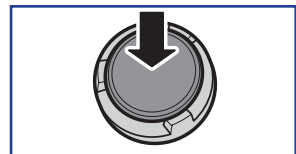
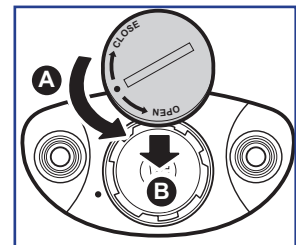

#### NOTE:

- When installing a new battery, if the battery is not placed with the positive connector first, the positive connector will easily deform and malfunction.
- Be careful not to damage or lose the O-ring gasket on the cover.
- Contact your local waste disposal department to properly dispose of used batteries.

# Install Rider 20

## Mount Rider 20 to the Bike

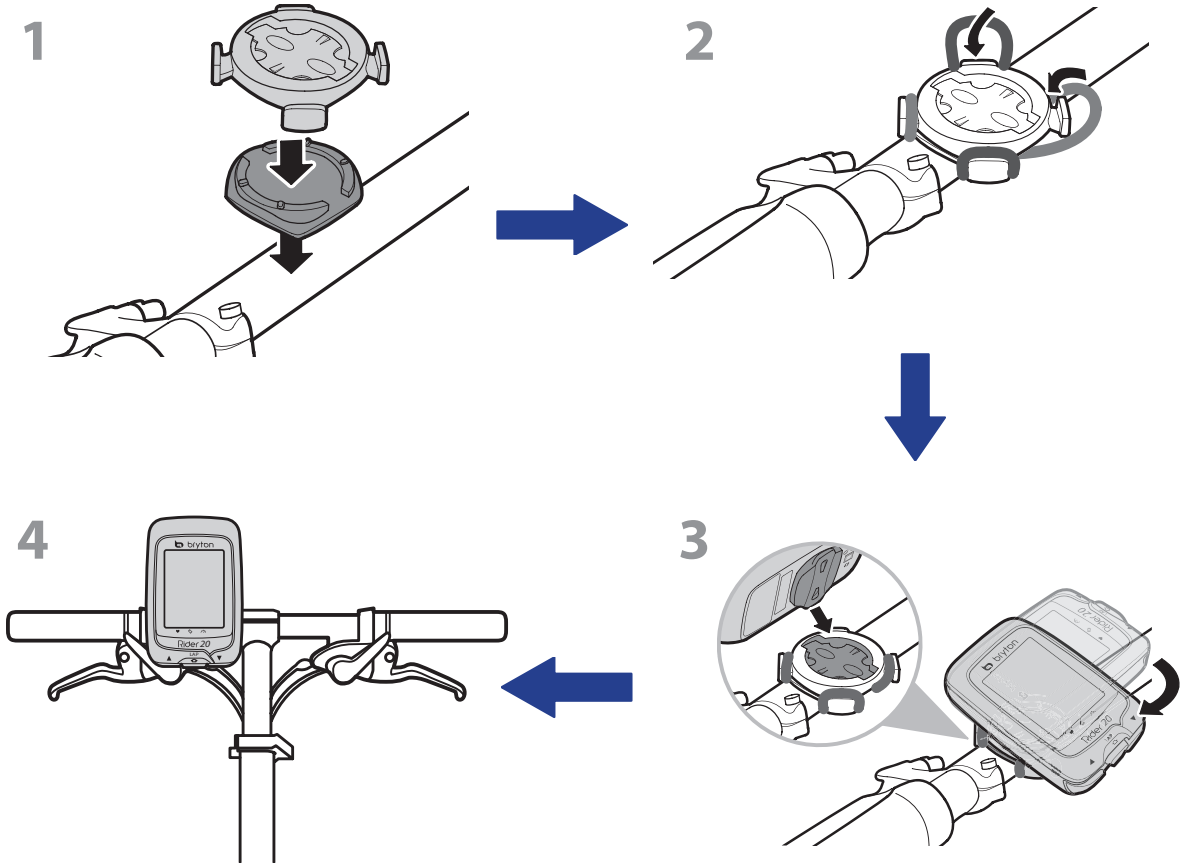

# Install the Speed/Cadence Sensor (Optional)

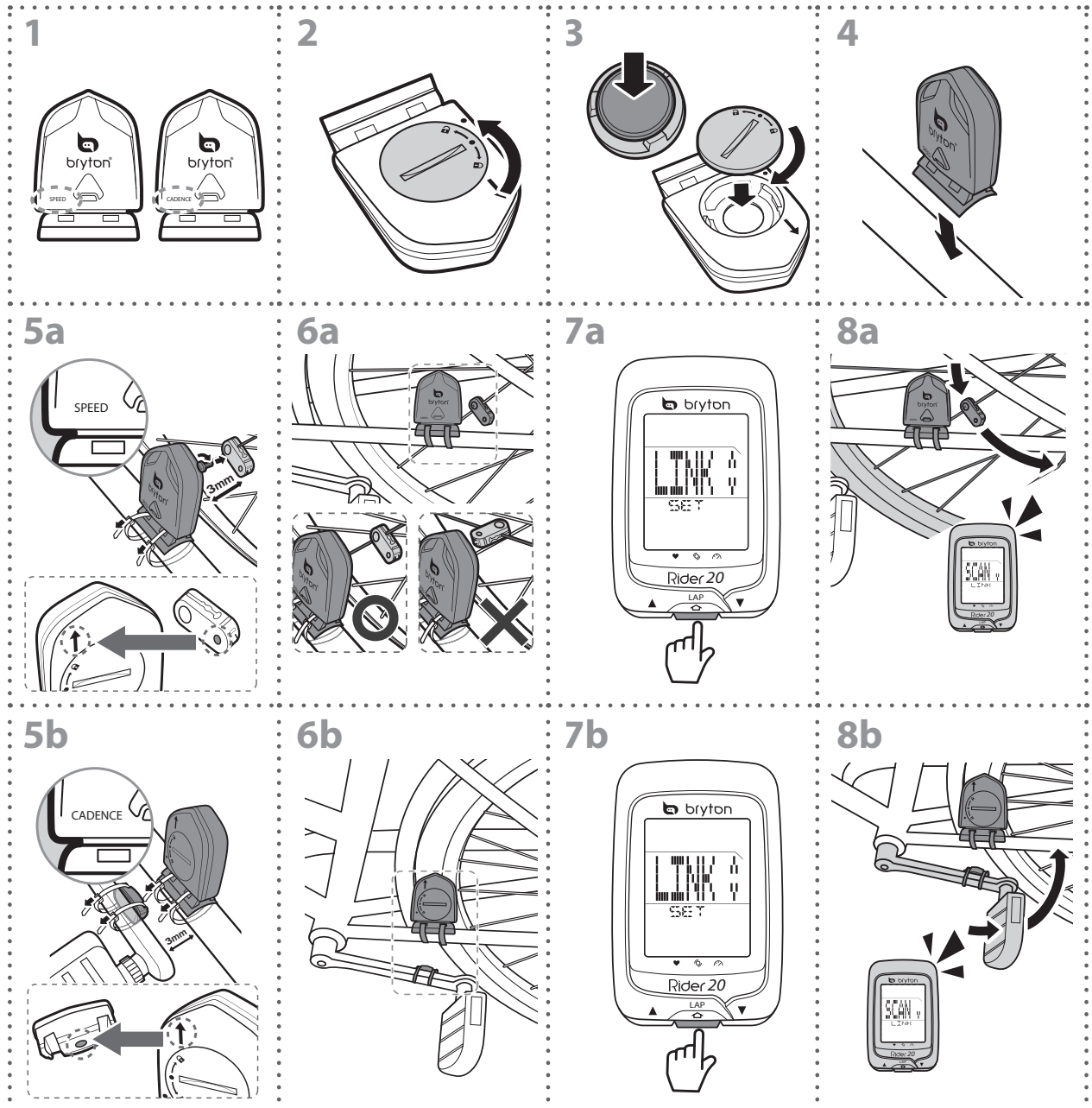

**NOTE:**

- To ensure optimum performance, do the following:
  - Align both sensor and magnet as shown in the illustration (5a / 5b). Pay attention on the alignment points.
  - Ensure the distance between the sensor and the magnet must be within 3 mm.
- Ensure that both Speed sensor and Speed magnet are installed and aligned horizontally, not vertically.
- On the initial usage, press the front button to activate the sensor and start pedaling. When the sensor detects the magnet, the LED blinks once to indicate the alignment is correct (the LED blinks only for the first ten passes after pressing the button).

## Install Heart Rate Belt (Optional)

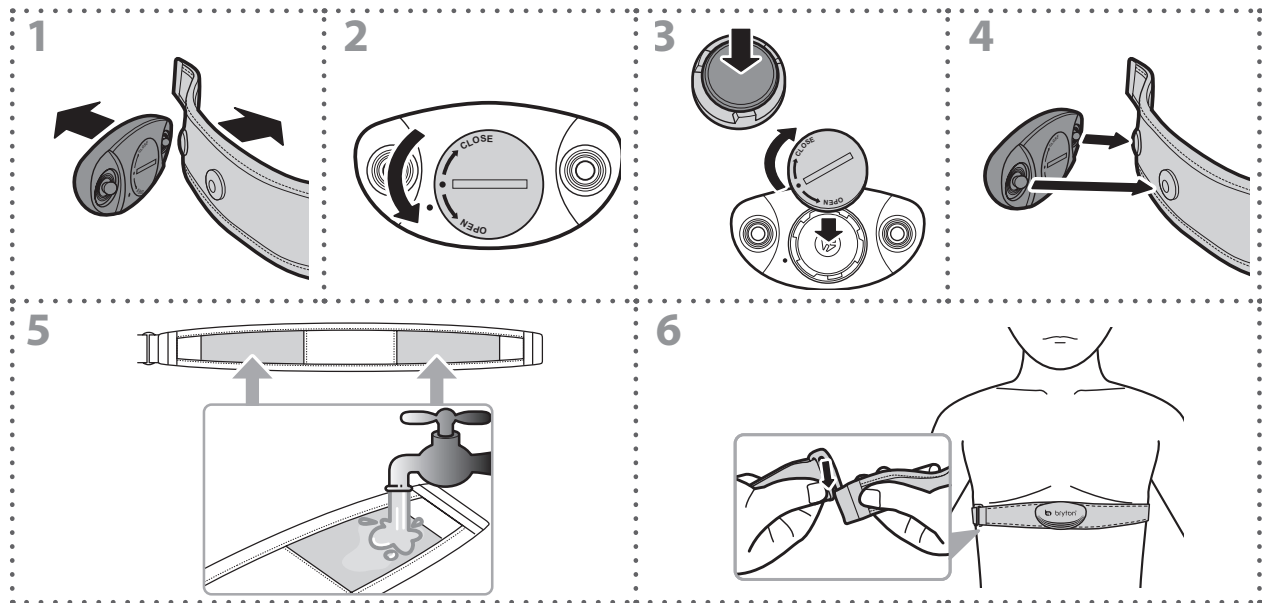
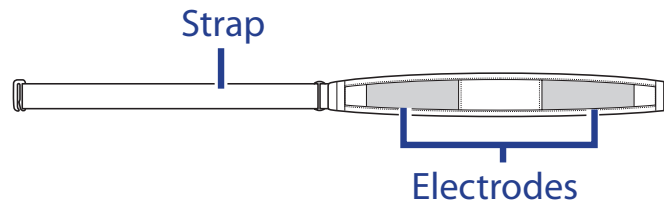

### NOTE:

- In cold weather, wear appropriate clothing to keep the heart rate belt warm.
- The belt should be worn directly on your body.
- Adjust the sensor position to the middle part of the body (wear it slightly below the chest). The Bryton logo shown on the sensor should be facing upward. Tighten the elastic belt firmly so that it will not turn loose during the exercise.
- If the sensor cannot be detected or the reading is abnormal, please warm up for about 5 minutes.
- If the heart rate belt is not used for a period of time, remove the sensor from the heart rate belt.

## Wheel Size and Circumference

The wheel size is marked on both sides of the tires.

Wheel Size	L (mm)
12 x 1.75	935
14 x 1.5	1020
14 x 1.75	1055
16 x 1.5	1185
16 x 1.75	1195
18 x 1.5	1340
18 x 1.75	1350
20 x 1.75	1515
20 x 1-3/8	1615
22 x 1-3/8	1770
22 x 1-1/2	1785
24 x 1	1753
24 x 3/4 Tubular	1785
24 x 1-1/8	1795
24 x 1-1/4	1905
26 x 2.10	2068
26 x 2.125	2070
26 x 2.35	2083
26 x 3.00	2170
27 x 1	2145
27 x 1-1/8	2155
27 x 1-1/4	2161
27 x 1-3/8	2169
650 x 35A	2090
650 x 38A	2125
650 x 38B	2105
700 x 18C	2070

Wheel Size	L (mm)
24 x 1.75	1890
24 x 2.00	1925
24 x 2.125	1965
26 x 7/8	1920
26 x 1(59)	1913
26 x 1(65)	1952
26 x 1.25	1953
26 x 1-1/8	1970
26 x 1-3/8	2068
26 x 1-1/2	2100
26 x 1.40	2005
26 x 1.50	2010
26 x 1.75	2023
26 x 1.95	2050
26 x 2.00	2055
700 x 19C	2080
700 x 20C	2086
700 x 23C	2096
700 x 25C	2105
700 x 28C	2136
700 x 30C	2170
700 x 32C	2155
700C Tubular	2130
700 x 35C	2168
700 x 38C	2180
700 x 40C	2200

## Screen Terminologies

Terminology	Screen Display
Training	TRAIN
Distance	DIST
Heart Rate	HRM
Speed	SPD
Cadence	CAD
Dual sensor	DUAL
Multiple sensors	MULTSENS
Set time	SET TIME
Location	LOCT
Daylight saving	DST
Adjust	ADJ
Key tone	TONE
Auto Scrolling	SCROLL
Stopwatch	STW
Clear storage	CLS

## Basic Care For Your Rider 20

Taking good care of your Rider 20 will reduce the risk of damage to your Rider 20.

- Do not drop your Rider 20 or subject it to severe shock.
- Do not expose your Rider 20 to extreme temperatures and excessive moisture.
- The screen surface can easily be scratched. Use the non-adhesive generic screen protectors to help protect the screen from minor scratches.
- Use diluted neutral detergent on a soft cloth to clean your Rider 20.
- Do not attempt to disassemble, repair, or make any modifications to your Rider 20. Any attempt to do so will make the warranty invalid.

