



# POSEIDON Tablet SY-Z19M4 9" Personal Tablet User Manual

## **Use of the Manual**

To ensure proper use of the tablet, read this user manual carefully before first use.

These instructions are based on the factory settings of the device.

It may be possible that some of the images and screenshots in this manual do not match the final product.

It is possible that the contents in this user manual do not match the final performance of the unit due to firmware upgrades.

Please visit [www.sytech.es](http://www.sytech.es) for the latest version of the user manual and firmware upgrades.

## WELCOME

Sytech thanks you for buying the POSEIDON SY-Z19M4 9" multi touch screen display tablet which has been specially designed to fulfil your needs and allow you to experience the new portable entertainment generation with just a few touches! Thanks to the Android operating system you can gain access to the internet, check your e-mail or even watch or listen to multimedia content anywhere at anytime. Furthermore, download and enjoy one of the thousands of applications and games available to get the most out of your POSEIDON SY-Z19M4.

## CARE AND MAINTENANCE

- Do not expose your tablet to direct sunlight, humidity, high temperatures, dirt or anything that can cause its malfunction.
- Do not use abrasive liquids or cleaners to clean the unit.
- Always maintain the device free from dust using a soft and dry cloth.
- When the battery level is low, please charge the unit avoiding it to discharge completely.
- Do not service the unit by yourself, please contact Sytech Service Centre for any assistance.

**NOTE: Sytech recommends the use of a screen protector in order to maintain the tablet in perfect conditions.**

## SPECIFICATIONS

- Portable Internet Tablet designed for Android 4.0
- Multi-touch 5 point capacitive screen
- 9" 16:9 TFT-LCD (800x480 pixels)
- Allwinner A13 1.0 GHz processor + 3D engine, 512kb L2 Cache, GPU Mali-400
- 512MB DDR3 RAM
- Integrated Wi-Fi
- Supports Wi-Fi USB 3G modem
- Front Camera 0.3 MP (640x480) / Rear Camera 2MP (1600x1200)
- Integrated Omni-directional microphone
- Integrated speaker
- Motion Sensor (accelerometer)
- USB-OTG – easy access to the memory of the tablet through the computer (cable included)
- 4GB built in memory
- Memory expandable via Micro SD-HC/XC cards (up to 32GB)
- 3.5mm earphone jack connector
- Charger: 5V, 2A
- 5000 mAh: up to 150 hours in standby mode and 4 hours in video mode
- Weight: ~487g
- Dimensions: 239,4x147,8x11,5mm
- Allows to install thousands of Applications and games available for Android operating system.
- Applications installed:
  - o Aldiko (books)
  - o Files
  - o Google Search
  - o Google Maps
  - o Google Chrome
  - o Google Latitude
  - o Calculator
  - o Calendar
  - o Camera
  - o Contacts
  - o Clock
  - o Email
  - o Gallery
  - o Recording
  - o Music
  - o Web Browser
  - o YouTube
  - o Twitter
  - o Skype
  - o Slide me
  - o Task Killer
  - o Gmail
  - o Flash Player
  - o Documents to go

**NOTE: Some applications may not work on the POSEIDON tablet as they are specially created for Mobile phones or for tablets with larger screens.**

## CONTENTS OF PACKAGE

POSEIDON SY-Z19M4 Tablet 8GB  
User Manual  
USB OTG 2.0 High speed Cable for PC connection  
AC/DC power adaptor – 100-240V AC 50-60Hz  
Leather pouch  
In Ear Earphones

## PICTURE DESCRIPTION

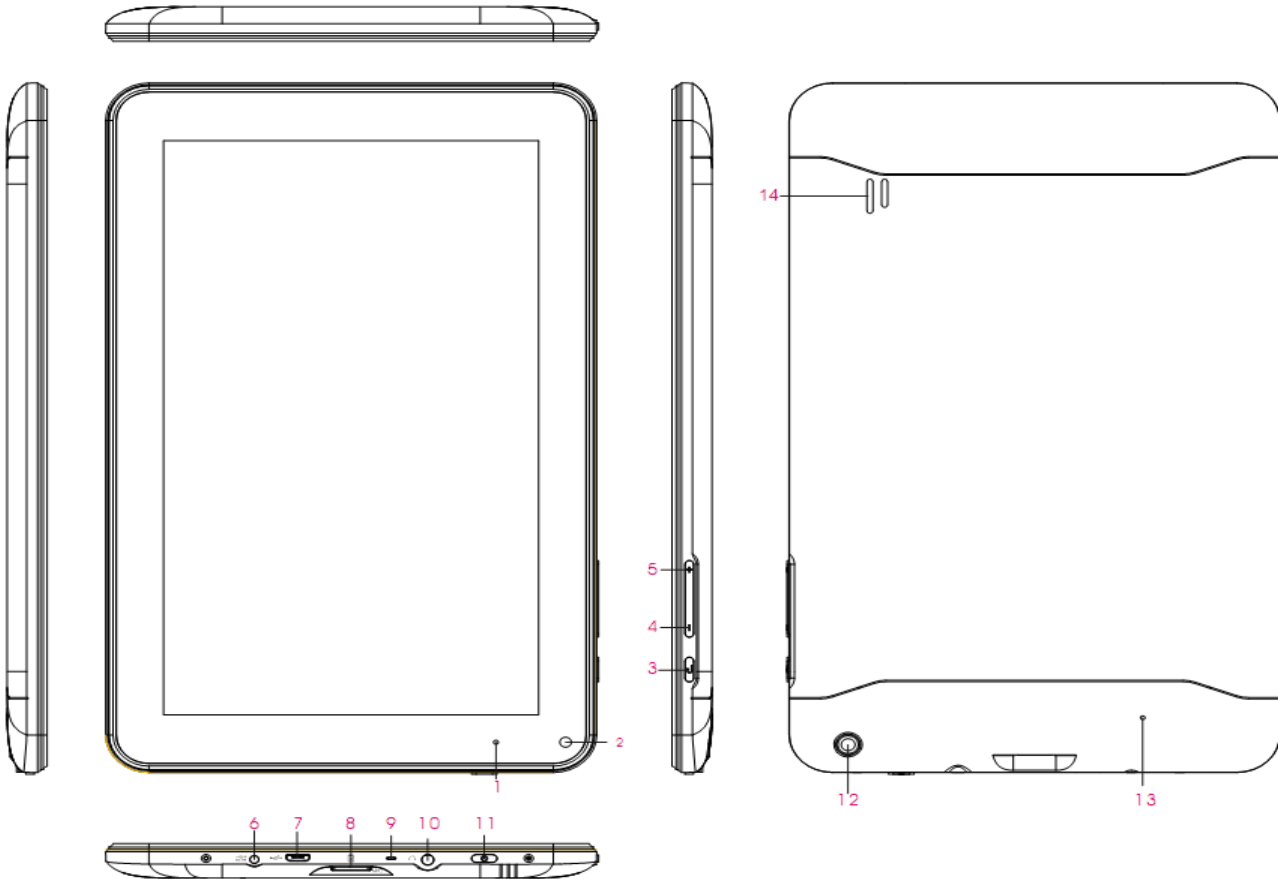

1. Indicator
2. Front Camera
3. Return Button
4. Volume -
5. Volume +
6. AC Charger input
7. Mini USB interface
8. TF Card interface
9. Microphone
10. Earphone Jack
11. Power On/Off
12. Rear Camera
13. Reset
14. Speakers

## TURNING ON AND OFF THE UNIT

To switch on your POSEIDON SY-Z19M4 tablet, press the On/Off button (1), located on the top left hand side of the unit, for a few seconds. Before being able to use the unit you will have to unlock the device. Drag the padlock towards the right (wave icons will be shown to indicate in which direction to move the padlock).

To turn off the unit, press the On/Off button (1) for a few seconds and the unit will turn off completely. If you press the On/Off button (1) once, the unit will enter into power saving mode.

**NOTE: To turn off the unit, you must press and hold the On/Off button. If it is only pressed the unit will only turn off the screen.**

## BATTERY AND POWER MANAGEMENT

The POSEIDON SY-Z19M4 tablet comes with an integrated rechargeable lithium ion battery. Before the first use of the unit, you may notice that the battery is relatively charged, however please perform a complete charge of the unit before using for the first time. In order to recharge the battery use the AC / DC 5V adaptor included. The usual time for a complete charge is around 3 – 4 hours approximately, this depends whether the unit is being charged while using or while it is turned off. There are certain settings which can be manipulated to prolong the battery life of the unit.

**NOTE: Sytech recommends turning off the unit always before charging in order to improve and extend the battery lifetime.**

## GESTURES KEY



Press

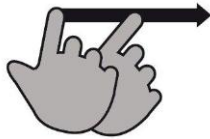

Flick



Press and Hold

## MAIN SCREEN



- |                |                                    |
|----------------|------------------------------------|
| 1. Search      | 7. Settings/Menu                   |
| 2. Return      | 8. Applications/Widgets on desktop |
| 3. Home        | 9. Time                            |
| 4. Tabs        | 10. Battery level                  |
| 5. Volume Down | 11. Applications/Widgets menu      |
| 6. Volume Up   |                                    |

## GENERAL SETTINGS

Set your POSEIDON tablets parameters to fit your needs. Enter into the settings menu and a list of options will appear.

### Wireless & Networks

Wi-Fi	Turn the Wi-Fi on or off.
Data Usage	Press this option to see the data usage of your POSEIDON tablet
More	Press this option to see more options under the Wireless and Networks settings.

### Device

Sound	Configure the volume levels and sound options
Display	Configure the different display settings (brightness, auto rotation, font size etc...)
Storage	Check the amount of space which is available on your POSEIDON tablet.
Battery	Check to see which application is using the most battery and check the current battery level
Apps	Check to see which applications have been downloaded, where they are stored, and which ones are currently running.

### Personal

Accounts & Sync	Manage your accounts through this section. You may add a new account if you do not have one already.
Location Services	Manage your location settings.
Security	Manage your security information through this option. (Passwords, user information etc...)
Language & Input	Set the device language and keyboard language through this option.
Backup & Reset	Backup the data on your POSEIDON tablet or perform a reset of the unit.

### System

Date & Time	Set the date and the time, manage the time zones, and select the formats for the time and date to be displayed.
Accessibility	Manage the system settings through this option.
Developer Options	Configure different options for the device when connected to a PC; configure User Interface, and configure Apps settings.
About Tablet	Verify all the settings and hardware information of your POSEIDON tablet through this option.

## WIDGETS

Widgets are applications, which allow easy access to some applications. In fact, it is more than a shortcut to an application as when you place them on your home screen like icons, they can show you the time, current weather or even your e-mail inbox without launching the application. To add widgets onto the desktop follow the steps below:

1. Press the “Applications and Widgets” icon situated on the top right hand side of the screen (1)



2. Press on the “Widgets” tab (1) which is situated on the top of the screen
3. Flick (2) through the widgets installed
4. Press and hold on the desired widget. (3)

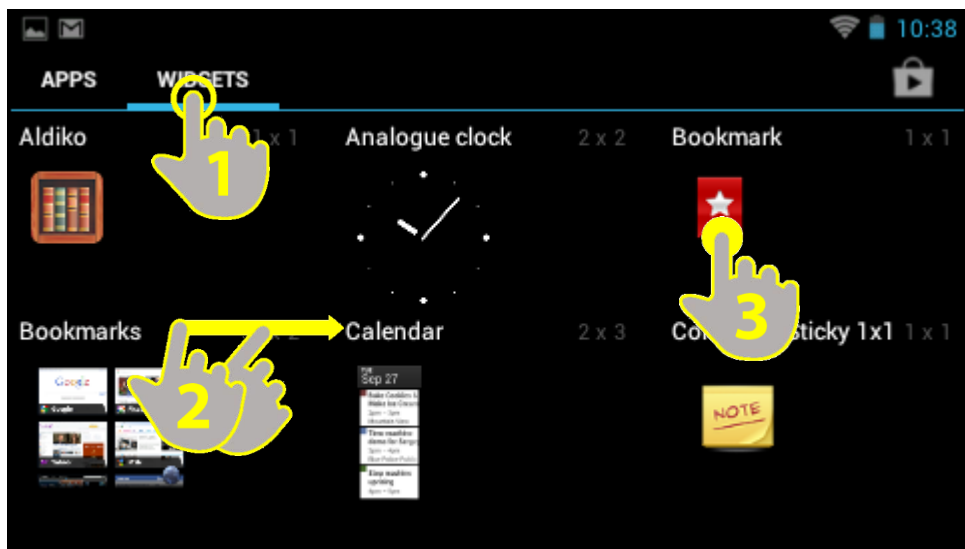

5. After a few seconds the desktop screen will appear (Continue pressing the icon at this point)
6. Drop and place the icon in the desired position on the desktop. The icon will now appear on your desktop as shown below.



Once the widget is on the desktop, you can move it around or delete it. To do this you must press and hold on the widget until it is highlighted. You may then move it around, or delete it by dragging it to the “X” icon which appears on screen.

## SETTING UP THE WI-FI NETWORK

1. Tap on the Settings icon on the main screen (1)



2. Under the “wireless and networks” section, flick the Wi-Fi switch to “ON” (1)

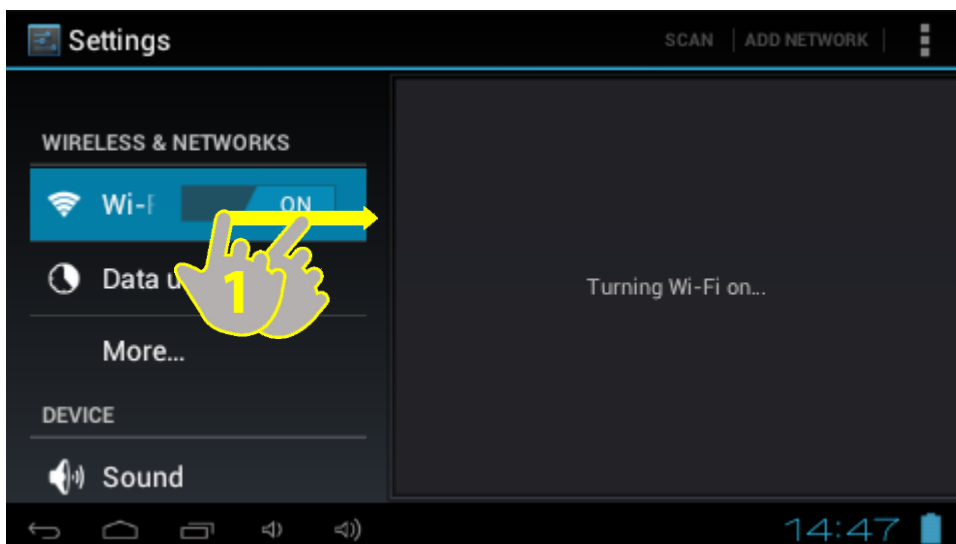

3. Select the desired Wi-Fi network from the list of available networks and enter the password, if required.

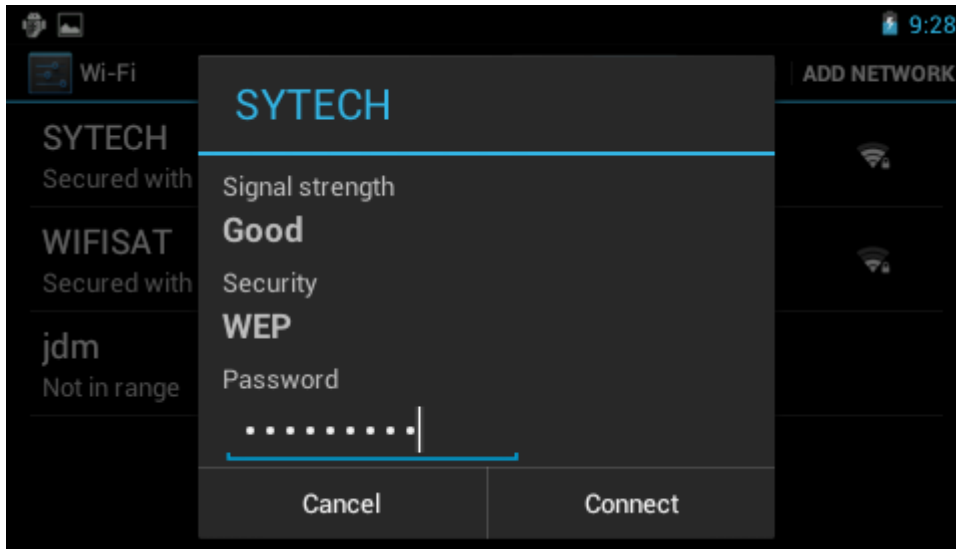

Once the authentication process has been completed; the device will save the data so that the next time you turn on the device it will automatically establish connection with the network (when in range) without having to repeat the authentication process. Your POSEIDON SY-Z19M4 tablet is now ready to surf the internet!

**NOTE: The POSEIDON SY-Z19M4 is compatible with the following security and encryption standards: WEP, WPA, WPA2, TKIP and AES.**

## INTERNET BROWSER

Your device comes with a powerful Web Browser which has already been pre-installed. The browser will allow you to surf the internet quickly and easily. When the device is connected to a Wi-Fi network, tap on the browser application icon (1) from the desktop or from the applications menu to begin using the internet. The default homepage will be displayed on screen; however, it is possible to modify the homepage and other parameters through the settings.







### Homepage

Tap on the address bar once (1). The current address will be highlighted and the keypad screen will appear. Type the desired webpage address and press enter (2).

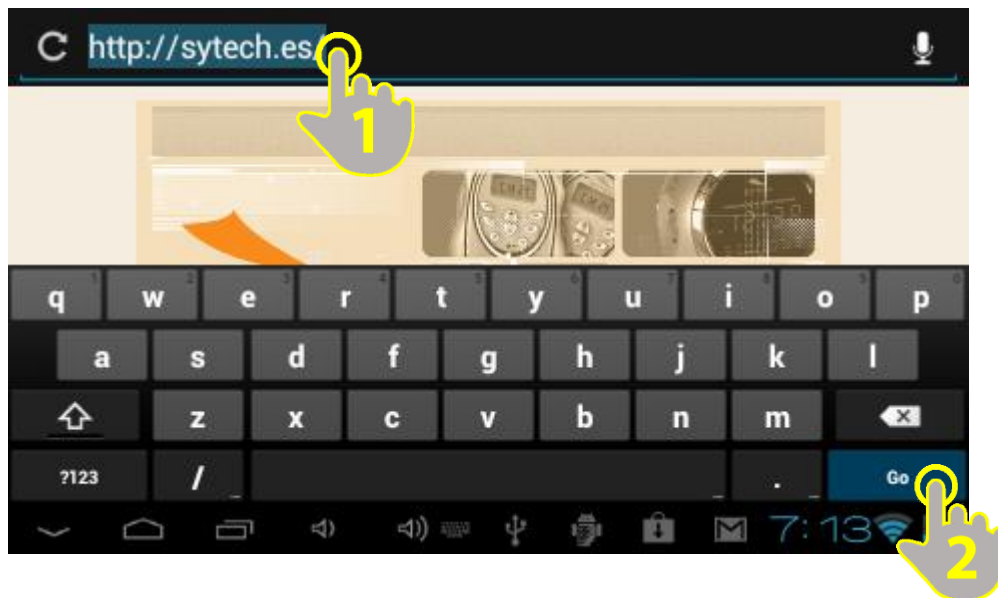

### Tabs

Press the tabs button (1) in order to view all the pages that are currently opened. You may shift from one website to another by simply pressing on any of the opened Web pages.



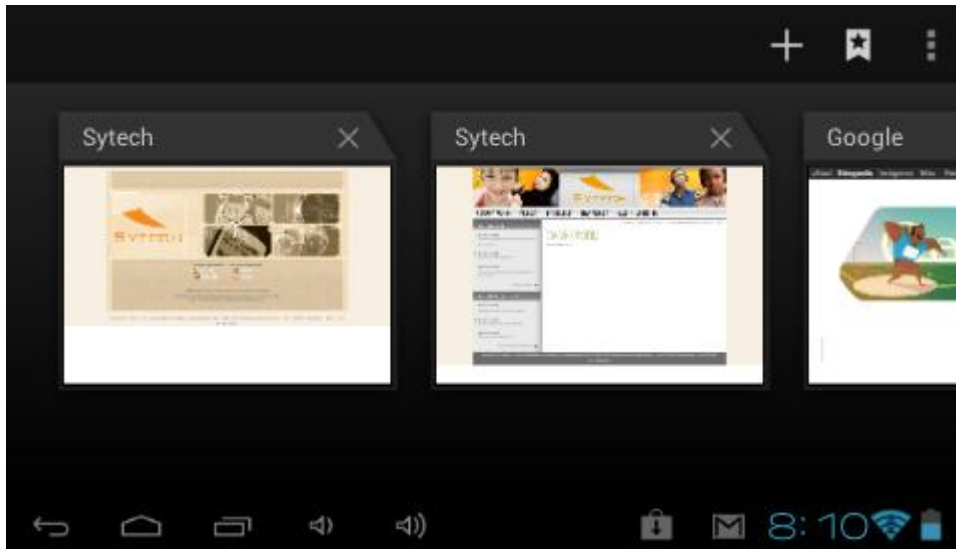

### **Menu Options**

Press the Menu Button (1) on the top right corner of the screen to access the different options as shown below.

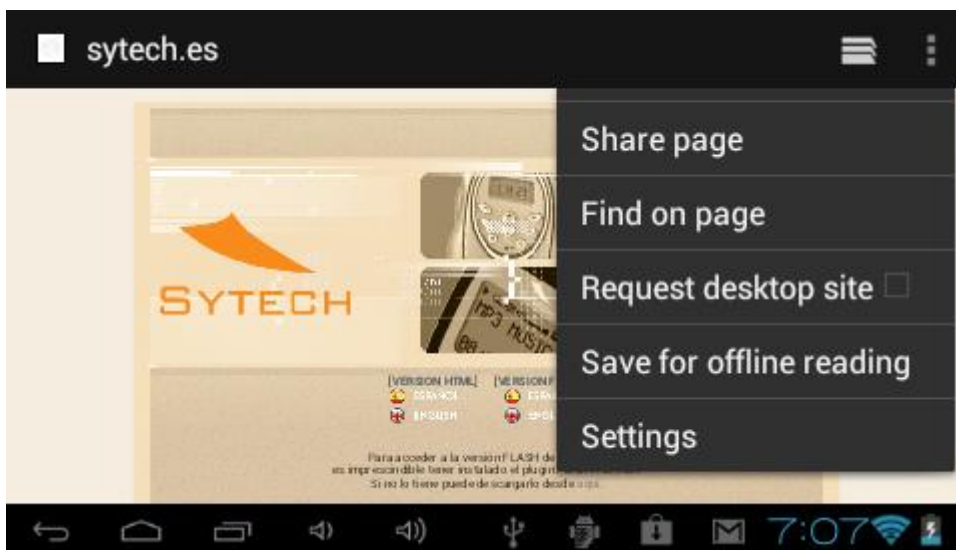
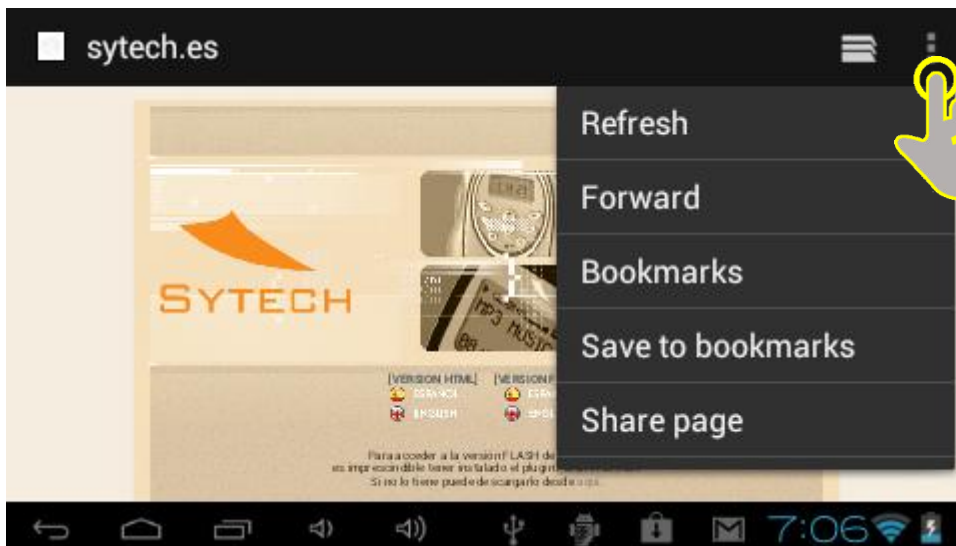

<b>Refresh</b>	Press this button to reload the page.
<b>Forward</b>	Press this button to move a page forward in your browser
<b>Bookmarks</b>	When pressing on this button, you will be directed to all the bookmarks which have been saved previously.
<b>Save to Bookmarks</b>	Press this button when you want to save a page and have easy access to it.
<b>Share Page</b>	Share the page you are browsing with someone through social media or e-mail.
<b>Find on Page</b>	Find a particular word or section within a page.
<b>Request Desktop Size</b>	Fit the page to the screen size.
<b>Save for Offline Reading</b>	Press this button in order to save the page and have later access to it even though there is no internet connection.
<b>Settings</b>	Press this button to change browser settings.

## E-MAIL SETUP

The POSEIDON SY-Z19M4 is also made to send and receive e-mails. In order to set up your e-mail on the device, follow the steps as shown below.

1) Click on the “E-Mail” application (1)

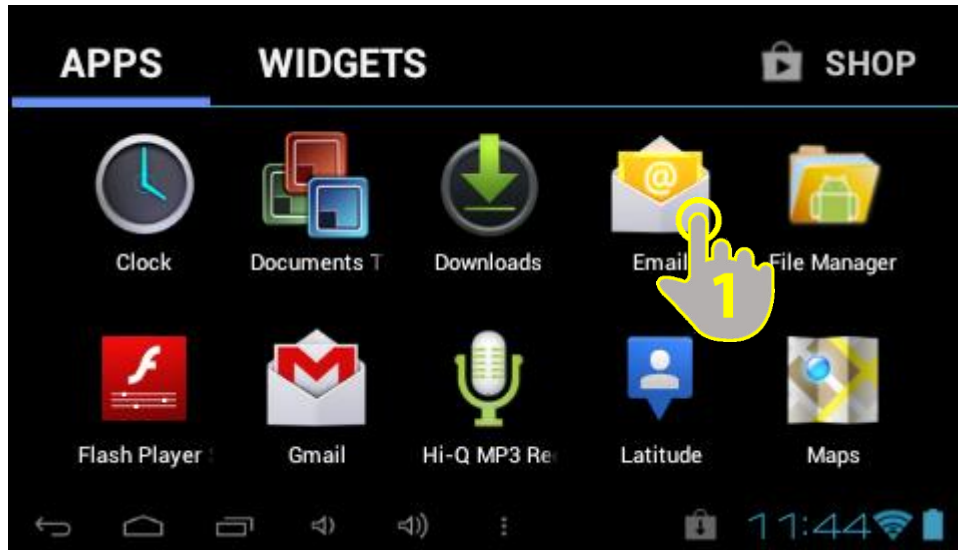

2) Insert your email address and the password. Once the setup process has been completed, you will begin to receive your e-mails on your POSEIDON tablet. If you have a POP3, IMAP or Exchange e-mail account, enter the email address and password and then press the “Manual Setup” button. Follow the steps which appear on screen to proceed with the e-mail setup process.

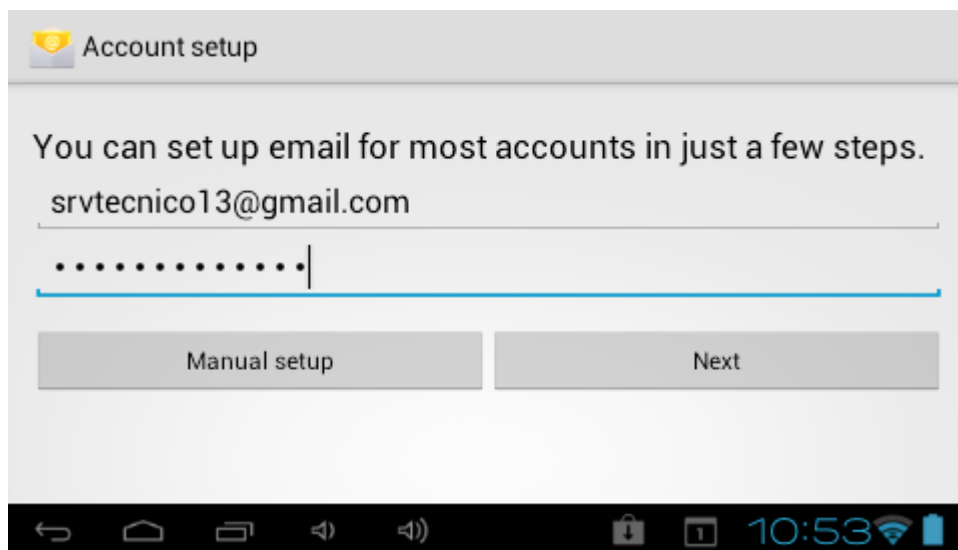

## Mail Box Features

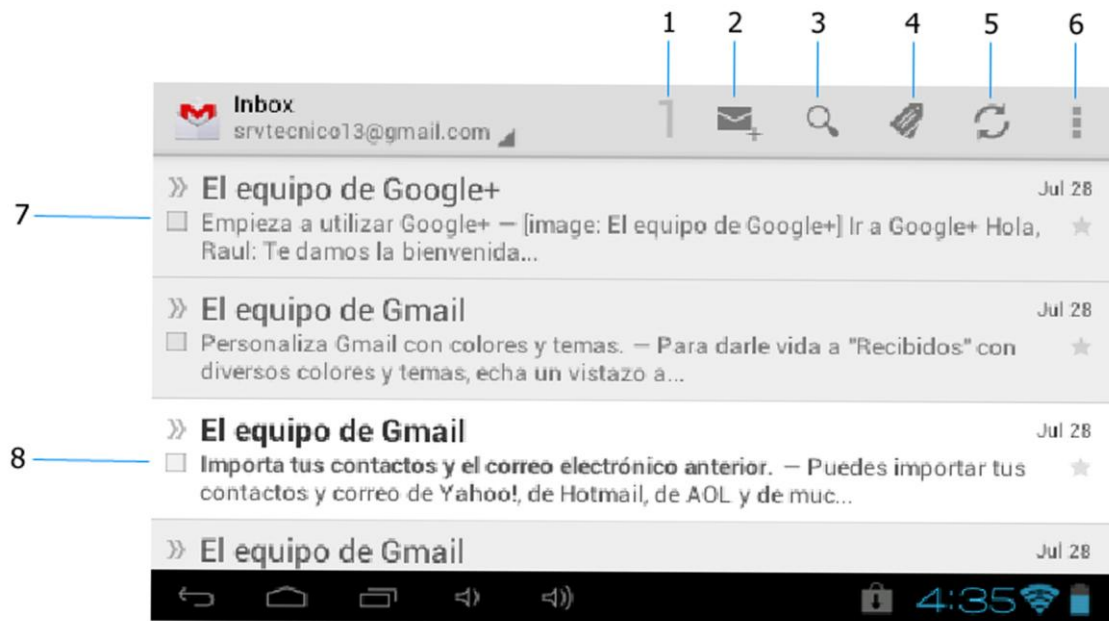

1. Number of e-mails received
2. Compose new e-mail
3. Search
4. Manage folders (Inbox, Sent, Outbox etc...)
5. Refresh / Check for new e-mails
6. E-mail settings
7. Received mail (Read)
8. Received mail (New)

## MUSIC PLAYER

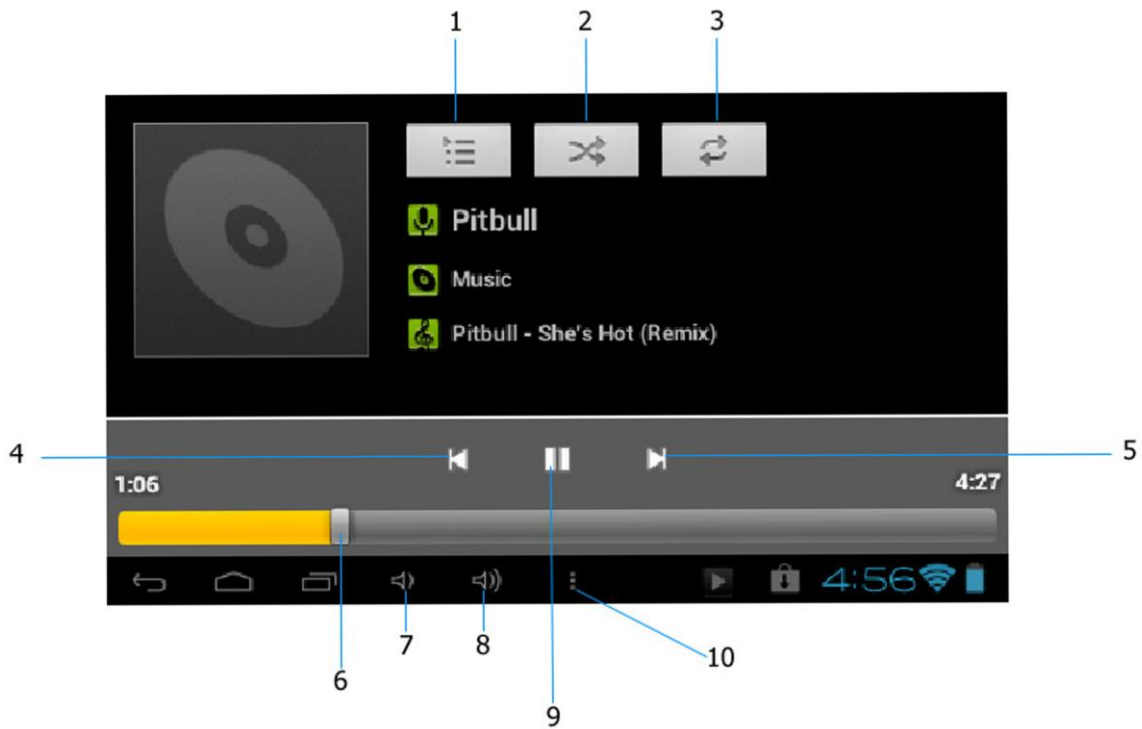

- |  |                  |
|--|------------------|
| 1 – Playlist                             | 6 – Time Elapsed |
| 2 – Shuffle                              | 7 – Volume Down  |
| 3 – Repeat all songs/Repeat current song | 8 – Volume Up    |
| 4 – Previous Song                        | 9 – Pause        |
| 5 – Next Song                            | 10 - Options     |

During the playback of music, press on the options button (Button 10) and you will see the following options:

<b>Library</b>	Press this button to view all the pictures as a presentation. Tap on the screen to return to normal viewing mode.
<b>Party Shuffle</b>	Press this button to play songs in a random order
<b>Add to Playlist</b>	Press this button to add the current playing song to an existing playlist or to a new playlist.
<b>Use as Ringtone</b>	Press this button to send the song into the Alarm tones folder. You may now set this song as your alarm ringtone through the “clock” application.
<b>Delete</b>	Press this button to delete the song from your tablet.
<b>Sound Effects</b>	Press this button to change the sound effects

## VIDEO PLAYER

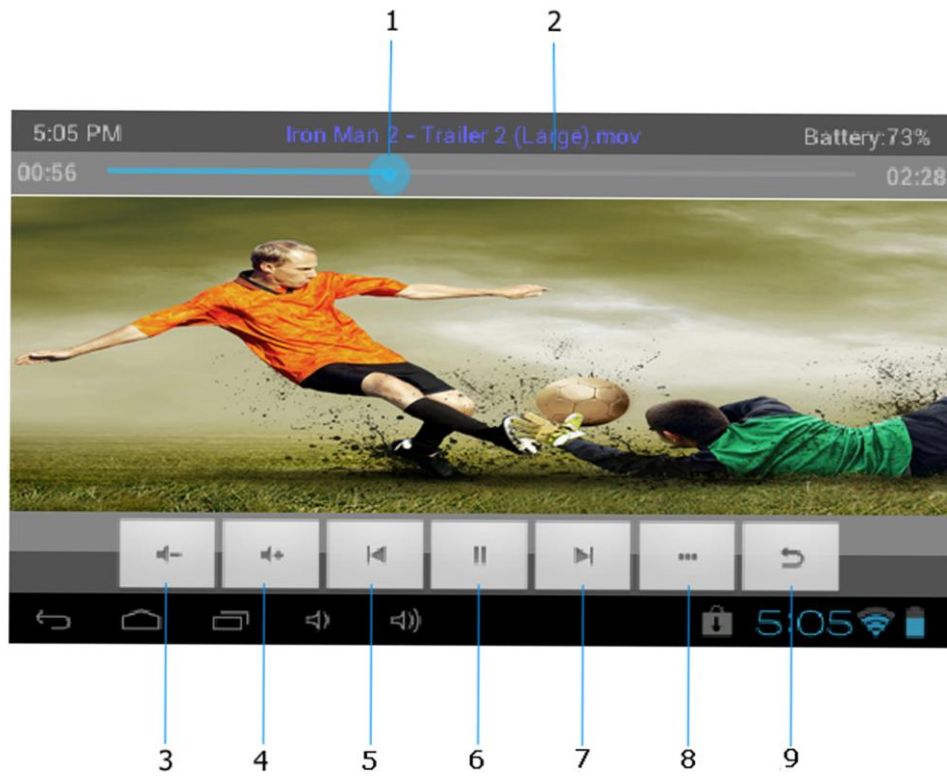

- 1 – Time elapsed
- 2 – Video Title
- 3 – Volume Down
- 4 – Volume Up
- 5 – Previous Video

- 6 – Pause
- 7 – Next Video
- 8 – Options (Aspect Ratio, Video Track, Repeat Mode)
- 9 – Restart

## PICTURE GALLERY

To view pictures on your POSEIDON tablet, access the picture folder and tap on any picture (1)

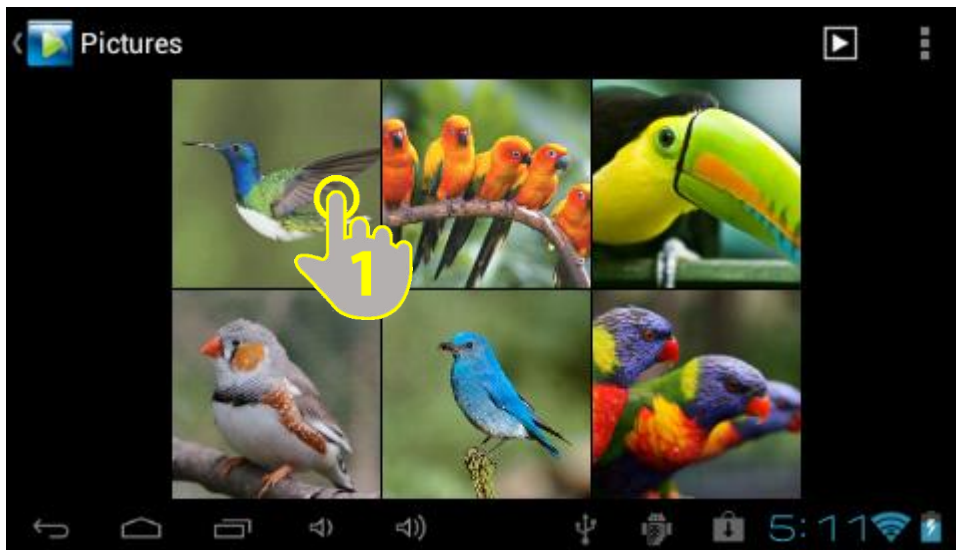

The image will be shown in full screen mode and thumbnails of the next and previous images will appear as a bar below. To view the next or previous image simply flick through the images (2)

Press the Share button on the screen to share the picture via Email or Social Media (3).

To delete a picture, press the trash can icon (4) and confirm the elimination of the picture.

Press the Settings button on the screen (5) and a drop down list of options will appear.

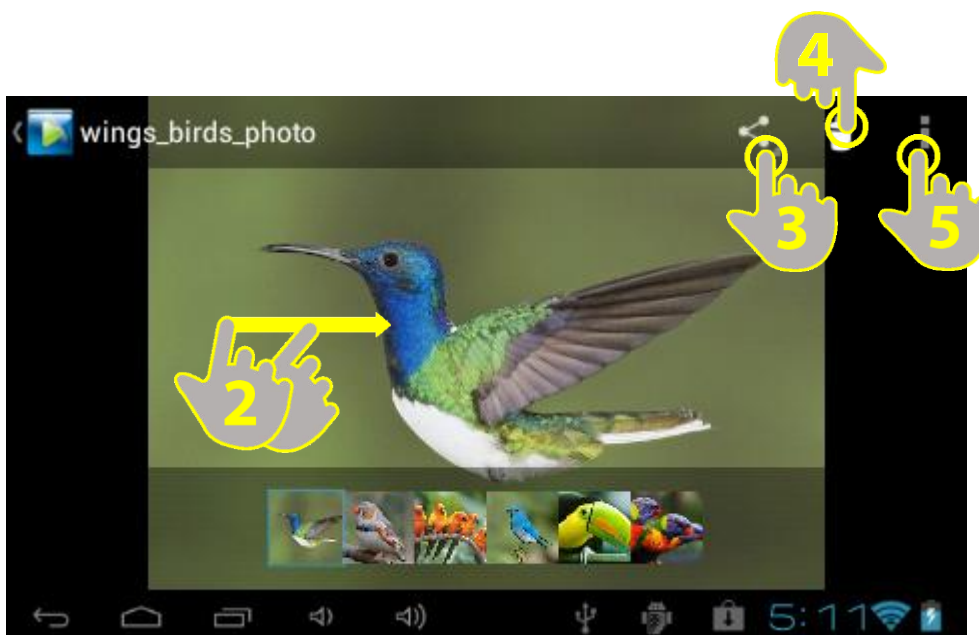



## Settings

<b>Slideshow</b>	Press this button to view all the pictures as a presentation. Tap on the screen to return to normal viewing mode.
<b>Edit</b>	Press this button to change the effects, lighting, colour and size and shape of the image.
<b>Rotate Left</b>	Turn the image 90° to the left
<b>Rotate Right</b>	Turn the image 90° to the right
<b>Crop</b>	Cut out any borders or sides.
<b>Set Picture As</b>	You can set the picture as a contacts photo or as your wallpaper.
<b>Details</b>	Image details such as size, date of modification and title will be shown.

## CAMERA

The POSEIDON tablet has an integrated rear camera of 2MP (1600x1200) which allows you to take pictures on the go.

### Camera

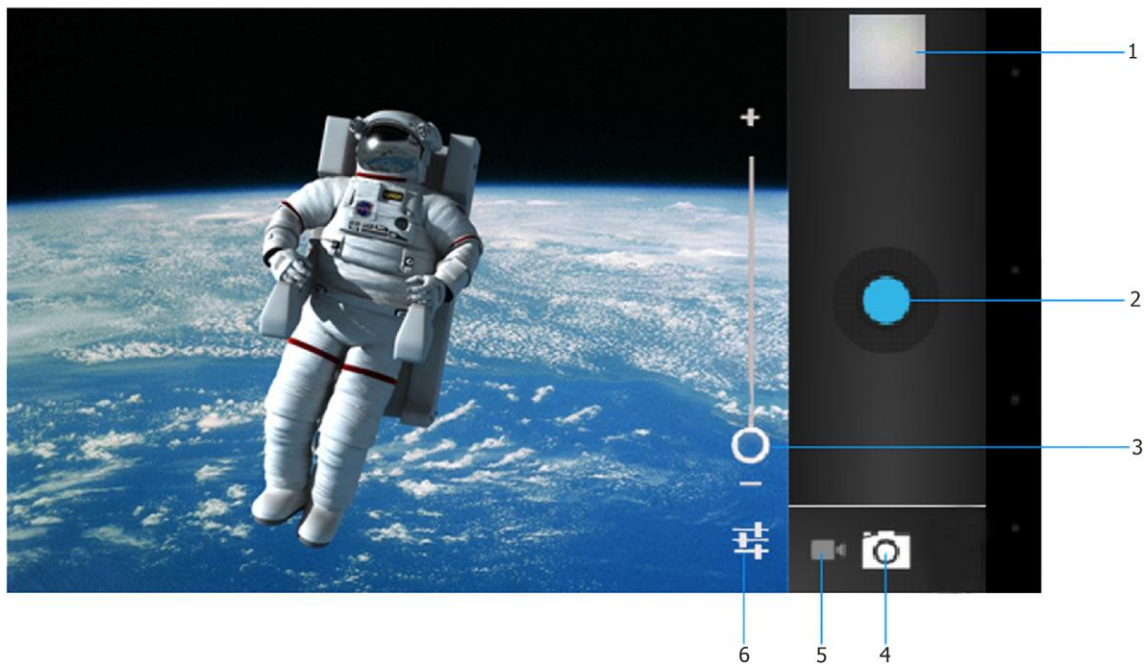

1. Image Thumbnail
2. Shutter
3. Zoom

4. Camera Mode
5. Video Recorder Mode
6. Settings

Press the shutter (1) to take a picture.

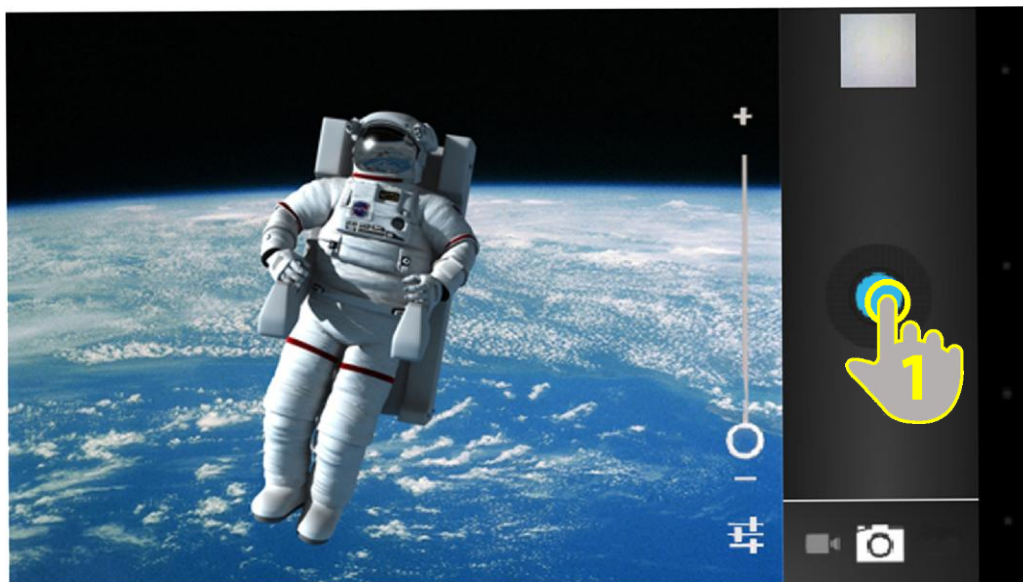

Once the picture has been taken, you may view it by clicking on the thumbnail on the top right, and options to Share via Email or Social Media will appear.

## Video Recorder

When you press on the Video Camera icon, the following screen will appear and the dot on the right will turn red. Press the Record button (1) and the device will begin recording.

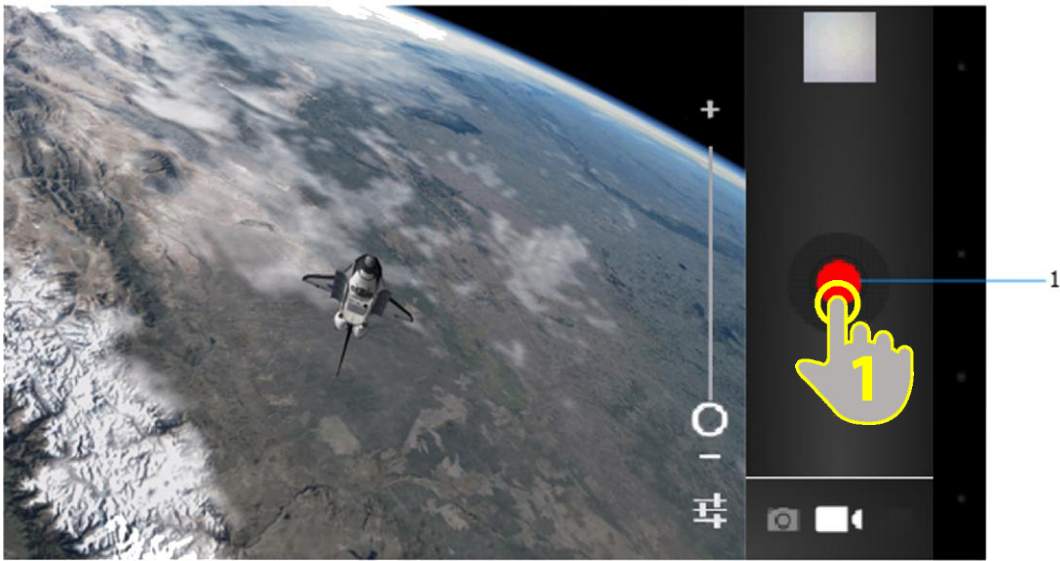

1. Record Button

Press the record button and you will see the following screen. The top left part of the screen will show you the time elapsed since the recording button was pressed. You may zoom in and out during the recording process by sliding the circle icon from – to + gradually.

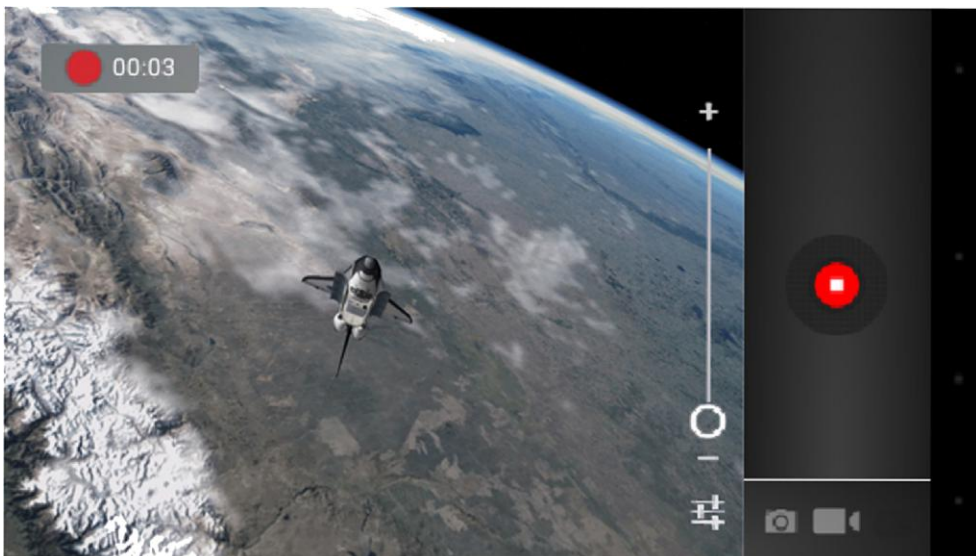

## CONNECTING THE TABLET TO A PC

Once you have connected the tablet to the PC, press the USB device icon that appears on the bottom of the screen (1)

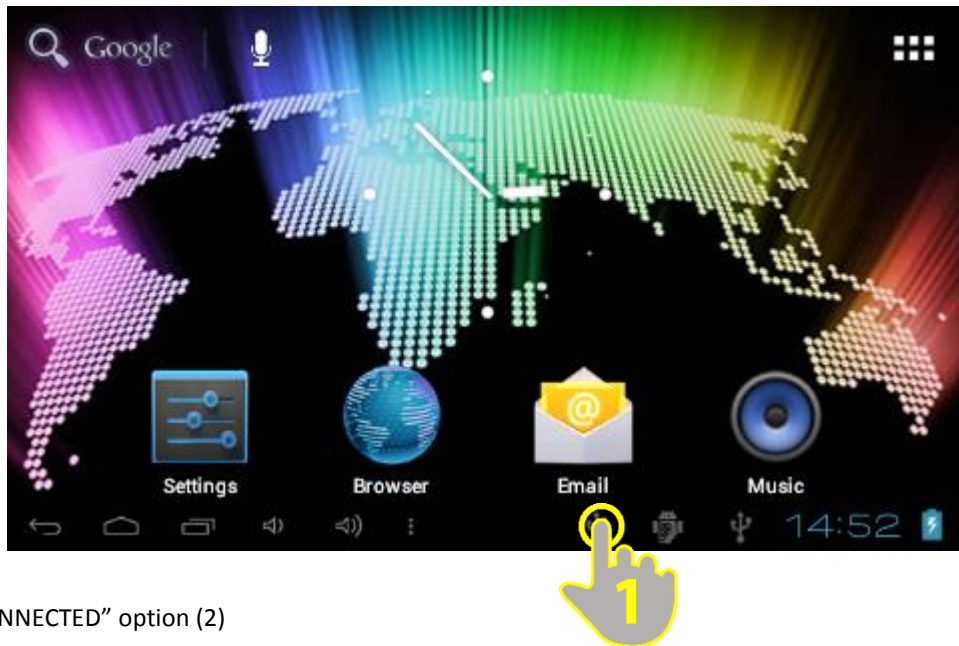

Select the “USB CONNECTED” option (2)



The following screen will appear. Press the “Turn on USB storage” (3) button and the device is now connected to the PC. At this point, some applications which you are using will be unavailable until the device has been disconnected from the PC.

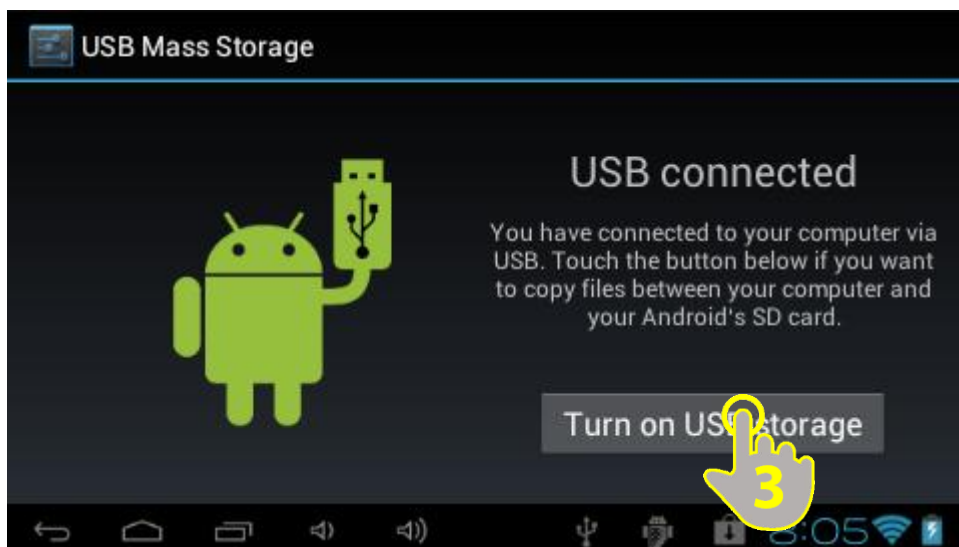

To disconnect the device from the PC, press the “Turn off USB storage” button at the bottom of the screen (4)

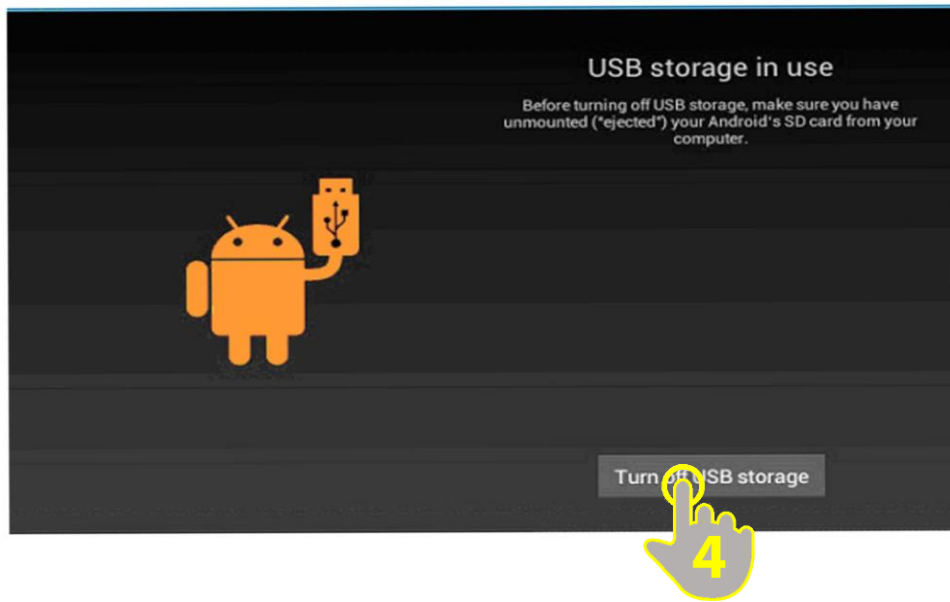

## TROUBLESHOOT

Below are a few problems that you may encounter during the use of your POSEIDON SY-Z19M4 tablet. Please read the following guide carefully. However if a major problem has been encountered with the device, please contact Sytech Service Centre for further assistance.

### **The device does not turn on**

Make sure that the battery has some charge which is sufficient for the device to turn on. If after having the device fully charged the problem still persists, please contact Sytech Service Centre for further assistance.

### **Some MP3 files do not work on the POSEIDON SY-Z19M4.**

The MP3 file must respect the layer 3 rules of MPEG1, MPEG2 and MPEG 2.5. Alternatively the file must be converted using special software.

### **Some WMA files do not work on the POSEIDON SY-Z19M4.**

Some WMA files may be protected with DRM rights which do not permit the file to be played on the device.

### **Some Music, Video and Image formats do not work on the device.**

Your POSEIDON SY-Z19M4 supports many different types of formats. However the ability to playback different formats also depends on the application being used. If for some reason one format cannot be played, please search for another application which is able to support the format required.

### **Some Apps do not work on the device after downloading and installing.**

Due to the different configurations of all the hardware's available, not all the applications will work in all the tablets. If an App doesn't work on your tablet, please contact the application developer for further information.

### **I connect the tablet to the PC but the PC does not recognize it.**

You have to disable the USB debug mode from your settings menu. The PC will then be able to detect the hardware connected to it. On the tablet you will see a screen asking if you want to turn on usb storage mode.

### **I upgraded the firmware and I want to retrieve my data back on the tablet.**

Sytech recommends the end user to perform a complete backup of the tablet before upgrading the firmware. If the backup has not been done and the firmware upgrade has taken place, it is not possible to retrieve all the data lost.

### **Is it possible to use 3G modems on SYTECH TABLETS?**

Depending on each tablet, you may or may not use any USB 3G modems. For the tablets that have a USB HOST port, you may use any USB 3G modem with Wi-Fi access.

### **Make sure your Wi-Fi is working well.**

If the Wi-Fi doesn't connect for any reason to the available network, and other devices, such as your personal laptop, cell phone etc it does connect; try changing around the security and encryption standards - WEP, WPA, WPA2, TKIP, and AES. One other possible problem could be the channels of the router. Change them around and configure it in different ways, however if it still does not work, you maybe having IP conflicts or experiencing a weak internet signal. Please contact your internet provider for further assistance.

You will be unable to download applications or use some applications properly without a proper internet connection. Please always make sure that the Wi-Fi is working properly.

**My POSEIDON SY-Z19M4 battery charge level runs out very quickly / Works very slowly from the first time I got it**

In order to preserve the battery charge for the longest time possible, always make sure that not too many applications are running in the background. However you may end these applications using the Task Killer application which has been pre-installed. E-mail also uses up a large portion of the battery level. It is recommended to change e-mail settings so that it checks for mail once every hour instead of once every 10 minutes. When the internet is not needed, it is recommended to turn off the Wi-Fi so that the battery charge can last longer. The same applies with the brightness, set it to a medium/low level to conserve the battery charge. Having it on 100% bright mode means that the battery charge will drain out quickly. All the above will also help your tablet to process tasks and applications quicker, therefore avoiding it to work slowly.

**My POSEIDON SY-Z19M4 froze**

In order to unfreeze the device you may perform a soft reset. With the aid of a thin sharp object, insert it into the pinhole button on the back of the unit to restart it. The unit will then shut down first and restart after a few minutes.

## DECLARATION OF CONFORMITY

Manufacturer Name: Satyatrade S. L.  
Address: Pol. Ind. La Raya. C/ Guadalquivir, 2.  
Camarma de Esteruelas, 28816 Madrid  
Tel: 902 430 967  
Fax: 91 8864285  
NIF: B83254763  
Manufacturing country: China  
Sytech® SY-Z19M4-POSEIDON

The following product complies with the Directive 1999/5/EC of the European parliament and of the Council of 9 March 1999

ROHS standard:2002/95/EC Restriction of Hazardous Substance

Signed: Ajeet Nebhwani Utamchandani  
Sole Administrator

