

LXC61X0

Generator controller user manual.

Ver1.0 Date: 2013/10/22

LXC 6120 series





LXC 6110 series



Version History

Date	Ver	Content
2013-10-22	1.0	Start publishing

Clarification of notation used within this publication:

Symbol	Instruction
 NOTE	Highlights an essential element of a procedure to ensure correctness.
 CAUTION	Indicates a procedure or practice, which, if not strictly observed, could result in damage or destruction of equipment.
 WARNING	Indicates a procedure or practice, which could result in injury to personnel or loss of life if not followed correctly.

LIXISE
SMART GENSET

Contents

1. Technical parameter.....	5
2. Product overview.....	6
3. Performance and characteristics.....	6
4. Order information and modules comparison.....	8
4.1. Order information.....	8
4.2. Modules comparison.....	10
5. Operation.....	11
5.1. Indicator light.....	11
5.2. Key functions.....	12
5.3. LCD Display.....	13
5.4. Advanced Parameters setting menu.....	15
6. Start、stop operation.....	15
6.1. Starting sequence:.....	15
6.2. Stopping sequence:.....	15
6.3. Manual start/stop operation.....	16
6.4. Manual start.....	16
6.5. Manual stop.....	16
6.6. LXC6120 Switch control procedures.....	17
6.6.1. Manual transfer procedures:.....	17
6.6.2. Auto transfer procedures:.....	17
6.7. LXC6110 Switch control procedures.....	17
6.7.1. Manual transfer procedures:.....	17
6.7.2. Auto control procedures:.....	17
7. SMS Remote control、wireless remote control function description (This feature is limited to rental business version)	18
7.1. LXI680 connection diagram.....	19
7.2. GSM alarm setting.....	19
7.3. Based on the GPRS DTU remote online monitoring.....	20

7.4. Wireless connection schematic diagram.....	22
7.5. Connect the controller through the DTU remote.....	23
7.6. DTU with the binding of the controller.....	23
7.7. Multilevel password management.....	23
8. History query (This feature is limited to rental business version)	24
8.1. Event log.....	24
8.2. Historical alarm data query.....	24
9. Protection.....	25
9.1. Shutdown alarm.....	25
9.2. Trip and stop alarm.....	26
9.3. Warnings.....	26
10. Wiring connection.....	28
11. Parameters setting.....	30
11.1. Advanced configuration parameters.....	30
11.2. Defined contents of configurable input ports.....	35
11.3. Enable definition of programmable output ports.....	36
11.4. Sensor selection list.....	37
11.5. Pressure unit conversion table.....	38
11.6. Conditions of crank disconnect selection.....	38
12. Typical application.....	40
13. Installation.....	43
14. Common faults and exclusion.....	45
15. Product packaging.....	45

1. Technical parameter

Items	Contents
Operating Voltage	DC8.0V to DC35.0V, Continuous Power Supply.
Power Consumption	<3W(standby:≤2W)
Alternator Input Range 3-Phase4-Wire 3-Phase3-Wire Single-phase2-wire 2-Phase3-Wire:	15V - 360 V AC (ph-N) 26V - 620 V AC (ph-ph) 15V - 360 V AC (ph-N) 15V - 360 V AC (ph-N)
Alternator Frequency	50/60Hz
Speed Sensor voltage VPP	2.2 - 100Vpp (Peak to peak)
Speed Sensor Frequency	10000Hz (max)
Start Relay Output	16Amp Controller Power Voltage Output
Fuel Relay Output	16Amp Controller Power Voltage Output
Programmable Relay Output 1	7Amp 250VAC Voltage Free Output
Programmable Relay Output 2	7Amp 250VAC Voltage Free Output
Programmable Relay Output 3	16Amp 250VAC Voltage Free Output
Programmable Relay Output 4	16Amp 250VAC Voltage Free Output
Case Dimension	210mm x 152 mm x 48 mm
Panel Cutout	186mm x 141mm
C.T. Secondary	5A Rated
Working Conditions	Temperature: (-25~+70)°C Humidity:(20~90)%
Storage Condition	Temperature::(-40~+85)°C
Protection Level	IP55:When waterproof rubber seal installed between the controller and panel fascia. IP42:When waterproof rubber seal is not installed between the controller and panel fascia.
Insulating Intensity	Object: input/output/power Quote standard: IEC688-1992 Test way: AC1.5kV/1min leakage current:3mA
Weight	0.68kg

2. Product overview

LXC61x0series of power plant automation controller for the automation and monitoring system of a single diesel generator sets, use 32-bit microprocessor technology, achieve generator sets automatic boot/shutdown, the precision measurement of various parameters, alarm protection and three remote function. The controller uses a large-screen LCD (240*128LCD)graphics display, all the important parameters can be displayed in page, save the page. At the same time can be displayed Chinese、English and other languages, all parameters can be adjusted from the controller panel, can also be a PC through a USB interface tweaks and RS485 or GPRS remote adjustment and monitoring. Its structure is compact, simple wiring, high reliability, automation control systems are widely used in all types of generator sets and fire pumps.

3. Performance and characteristics

LXC6110:Auto Stare Module, controls genset to start or stop automatically by remote start signal.

LXC6120:Auto Main Failure, updates based on LXC6110,especially for automatic system composed by generator and mains.

Main characteristics:

- ❖ With ARM-based 32-bit CPU, highly integrated hardware, new reliability level;
- ❖ 240x128 LCD with backlight, multilingual interface(including English, Chinese or other languages) which can be chosen at the site, making commissioning convenient for factory personnel;
- ❖ All parameters can use the computer via USB, RS232, RS485 interface to connect and adjust, while the internal FLASH memory within the controller in the system when power is not lost;
- ❖ 99% of the parameters can be set directly from the front panel for easy on-site commissioning;
- ❖ RS485 communication port enabling remote control, remote measuring, remote communication via Mod Bus protocol (controller with RS485 port only);
- ❖ Equipped with SMS(Short Message Service)function. When genset is alarming, controller can send short messages via SMS automatically to max.5 telephone numbers. besides, generator status can be controlled and checked using SMS. With advanced networking capabilities, via GPRS mobile network and Internet connectivity, in any place where the network can be remotely monitor;(Need to install the GPRS module: LXI680);
- ❖ Suitable for 3-phase 4-wire,3-phase 3wire,single phase 2-wire,and 2-phase 3-wire (120/240V)power and 50/60Hz Systems;
- ❖ Collects and shows 3-phase voltage, current, power parameter and frequency of generator or mains;
- ❖ For Mains, controller has over and under voltage, over and under frequency, loss of phase and phase sequence wrong detection functions; For generator, controller has over and under voltage, over and under frequency, loss of phase, phase sequence wrong, over current functions;
- ❖ 3 fixed analog sensors(temperature, oil pressure and liquid level),more kinds of curves of temperature,oil pressure, fuel level can be used directly and users can define the sensor curves by themselves;
- ❖ Protection: Automatic start/stop of the genset, ATS(Auto Transfer Switch)control with perfect fault indication and protection function. When multiple warnings occur, the warning bar will rotate to display them, so that we can analyze the reasons;
- ❖ All output ports are relay-out, And the main output 16A relay outputs and three passive relay output, more user-friendly;

- ❖ Parameter setting: parameters can be modified and stored in internal FLASH memory and cannot be lost even in case of power outage; most of them can be adjusted using front panel of the controller and all of them can be modified using PC via USB or RS485 ports.
- ❖ With advanced networking capabilities, via GPRS mobile network and Internet connectivity, in any place where the network can be remotely monitor;
- ❖ A variety of starting conditions for success (speed sensor, oil pressure, power generation) to select, to facilitate the needs of special occasions;
- ❖ Wide power supply range (8 ~ 35) VDC, can adapt to different environment starting battery voltage, can under the low voltage of starting motor moment continue to work for 3 seconds;
- ❖ Fault history with 200, and can record the fault instant oil pressure ,water temperature, voltage, current and other important parameters;
- ❖ Equipped with real-time clock,regular maintenance functions;
- ❖ Can be used on pumping units and as an indicating instrument (indicate and alarm are enable only, relay is inhibited);
- ❖ 3 set of maintenance functions, can be set for the machine maintenance cycle .Maintenance time to action can be set up(only warning or alarm stop);
- ❖ Waterproof security level IP55 due to rubber seal installed between the controller enclosure and panel fascia;
- ❖ Improved LCD wear-resistance and scratch resistance due to hard screen acrylic;
- ❖ Silicon panel and push buttons for better operation in high-temperature environment,and has a good waterproof performance;
- ❖ Modular design, anti-flaming ABS plastic enclosure, plug gable connection terminals and embedded installation way, compact structure with easy mounting.

Special industry application characteristics:

- ❖ Leasing industry applications: management provides the perfect solution: leased out via PC remote Management of the unit, you can monitor all operating parameters (oil pressure, water temperature, voltage, current, power, etc),you can always change the configuration to protect the unit is not proper application, can record 200 detailed fault information, including: time to failure, because ,when the voltage, current, power, oil pressure, water temperature and other key parameters, and ready to upload to the monitoring machine. Another multi-level password management options to facilitate the lease management;
- ❖ Fire pump industry applications: Close electrical parameter measurement function, use powerful Programmable input and output ports and internal programmable logic to achieve automated pump control system. Instead of the conventional engine controller PLC + simple manner ,making the system more stable and reliable;
- ❖ Air compressor industry applications: Close voltage measurements protection, according to the need to configure programmable analog input, overload protection , with programmable digital inputs, complete startup control, temperature and pressure control, protection parameter settings.

Fully functional, and can detect almost all the generating units of electrical parameters and non-electrical parameters

Mains

Line voltage Uab, Ubc, Uca
Phase voltage Ua, Ub, Uc
Frequency Hz

Gens

Line voltage Uab, Ubc, Uca
Phase voltage Ua, Ub, Uc
Frequency Hz
Load current IA, IB, IC
Each phase and total active power kW
Each phase and total reactive power kVar
Each phase and total apparent power kVA
Each phase and average power factor PF
Accumulate total gens power kWh、kVarh、kVAh

Sensor

Temperature WT °C/°F Choose to display
Oil pressure OP kPa/Psi/Bar Choose to display
Fuel level (FL) %(unit)
Speed (SPD) RPM (unit)
Voltage of Battery(VB) V(unit)
Voltage of Charger(VD) V(unit)
Hour count(HC)can accumulate Max.65535hours
Start times can accumulate Max.65535times

Mains and generator abnormal conditions:

Voltage is too high
Voltage is too low
Phase loss
Reverse phase
Loss of power

The fault display and protection function project:

High water temperature warn
High water temperature shutdown alarm
Low oil pressure warning
Over speed shutdown alarm
Box high temperature warn
Low fuel level warn
Battery voltage is too high warn
Battery voltage is too low warn
Load over current shutdown alarm
Failed to stop alarm
Emergency stop alarm
Oil pressure sensor open circuit shutdown alarm

4. Order information and modules comparison

4.1. Order information

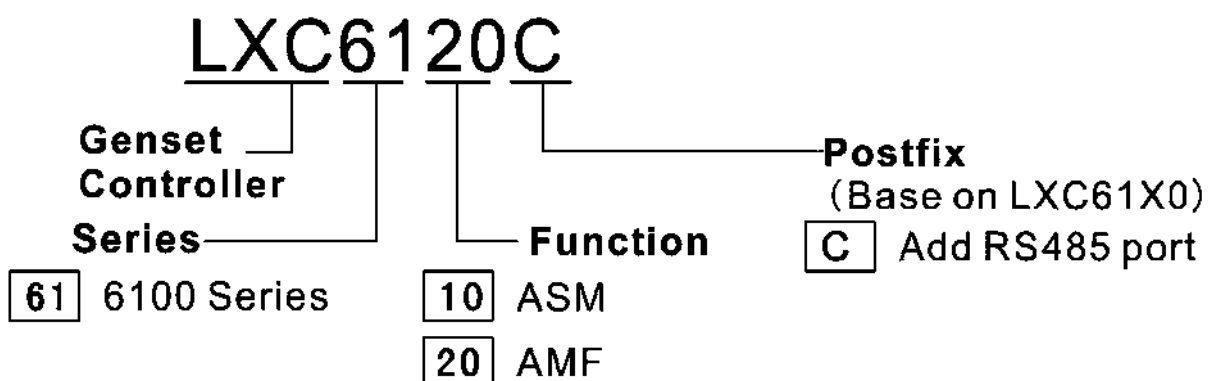

NOTE:

(1) It is basic model if without postfix.

(2) Please contact with our qualified personnel for more information about the postfix descriptions.



4.2. Modules comparison

Items	LXC 6120	LXC 6110	LXC 6120C	LXC 6110C
Input Port	5	5	5	5
Output port	6	6	6	6
Sensor number	3	3	3	3
AMF	•		•	
RS485			•	•
GSM SMS control	•	•	•	•
GPRS Remote monitoring	•	•	•	•
CAN(J1939)				
USB	•	•	•	•
Real-time clock	•	•	•	•
Event log	•	•	•	•

NOTE:







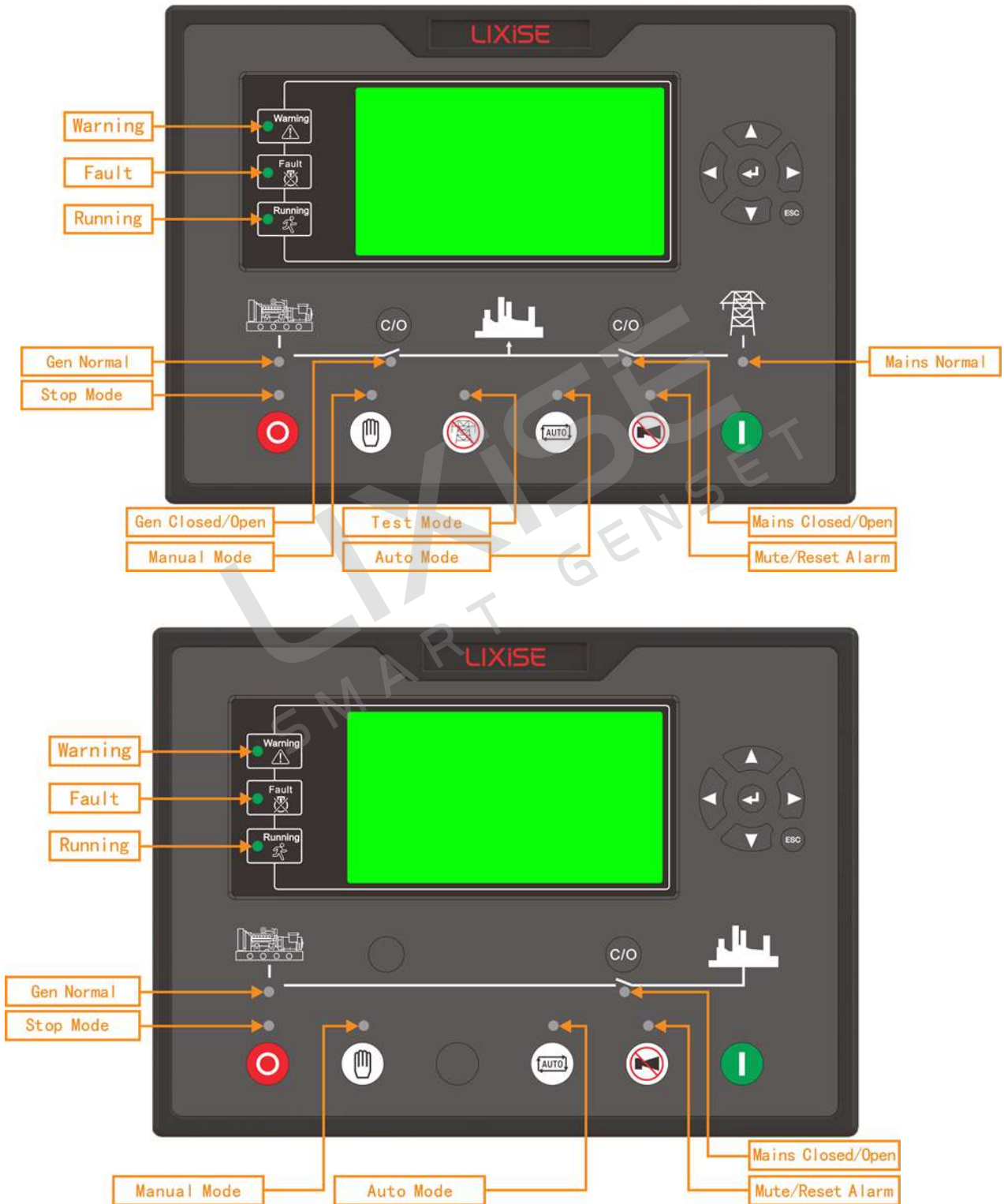







- ① Two of the outputs are fixed: start output and fuel output.
- ② LXC6120/6110 controller analog sensors are composed by 3 fixed sensors (temperature, pressure, fuel level).



5. Operation

5.1. Indicator light



5.2. Key functions

	Stop/Reset	Stop running generator in Auto/Manual mode; Reset alarm in stop mode; During stopping process, press this button again to stop generator immediately.
	Start	Start genset in Manual mode or Manual Testing mode.
	Manual Mode	Press this key and controller enters in Manual mode.
	Auto Mode	Press this key and controller enters in Auto mode.
	Running With Load	Press this key and controller enters in Manual Testing mode. (LXC6110 without)
	Mute/Reset Alarm	Alarming sound off; If there is trip alarm, pressing the button can reset this alarm. But you can't reset other alarm types
	Gen Closed/Open	Can control generator to switch on or off in manual mode.
	Mains Closed/Open	Can control mains to switch on or off in manual mode.(LXC6110 without)
	Confirm	1.Set parameters, press Key can set the parameters. 2.Set parameters, press the Kin can set parameters to confirm. 3.Long press the confirm key , can enter the parameter Settings.
	Up/Increase	Up cursor and increase value in setting menu.
	Down/Decrease	Down cursor and decrease value in setting menu.
	Move left	1.Screen scroll. 2.Move the cursor to the left in the set.
	Move right	1.Screen scroll. 2.Move the cursor to the right in the set.
	Quit	1.When the screen displays other parameters, press this key to return to the main screen. 2.Set the parameters, press this key can cancel parameter settings. 3.Enter the parameter setting, long press this button to return to the main screen.

✧ **Tips:**In the main interface, press   and from view different interface, press  to return to the main interface.

✧ **Tips:**Press  over 3 seconds , go into basic parameters setting menu.

✧ **Tips:**default password is 0000, user can change it in event of others change the senior parameters setting. Please closely remember it after changing If you forget your password, please contact our customer service, long press the confirm  key,all the information back to the service personnel. (Example, under the figure information)

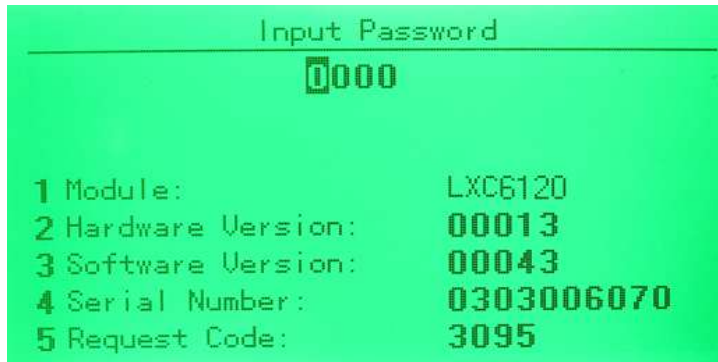

5.3. LCD Display

In the main interface, press and from the different interfaces, press to return to the initial page.

Main Interface (Commonly used parameter interface)

(The main interface contains, engine, generator, and status display)



Engine parameters

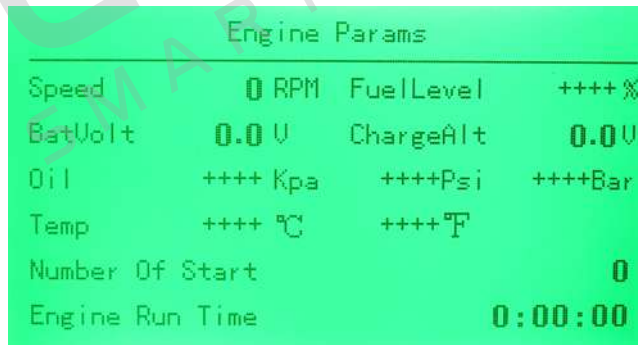

Load

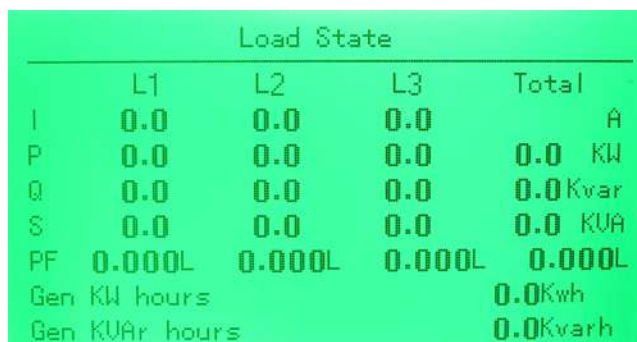

Generator

Generator				Freq	0.00Hz
	L1(L1-2)	L2(L2-3)	L3(L3-1)		
L-N	0.0	0.0	0.0	U	
L-L	0.0	0.0	0.0	U	
Phase	0.0	0.0	0.0		

Relay Output Status			
OUT1	OUT2	OUT3	OUT4
↘	↘	↘	↘

Mains Interface

Mains				Freq	0.00Hz
	L1(L1-2)	L2(L2-3)	L3(L3-1)		
L-N	0.0	0.0	0.0	U	
L-L	0.0	0.0	0.0	U	
Phase	0.0	0.0	0.0		

Digital Input Status				
IN1	IN2	IN3	IN4	IN5
↘	↘	↘	↘	↘



Input Password (Password input interface into the Advanced Configuration)

Input Password	
0000	
1 Module:	LXC6120
2 Hardware Version:	00013
3 Software Version:	00043
4 Serial Number:	0303006070
5 Request Code:	3095

Advanced configuration parameters

Advance Configs	
1 Timer	Settings
2 Engine	Settings
3 Generator	Settings
4 Mains	Settings
5 Sensor	Settings
6 Digital Input	Settings
7 Relay Output	Settings
8 Module	Settings

5.4. Advanced Parameters setting menu

Long press the  key, enter the correct password to enter the advanced parameters configuration menu, press  to return to the previous menu.

1 Timer
2 Engine
3 Generator
4 Mains
5 Analog Sensor
6 Digital Inputs
7 Digital Outputs
8 Module

6. Start、 stop operation

Press , its indicator lights, and controller enters Auto mode.

6.1. Starting sequence:





1. LXC6120:When Mains is abnormal(over and under voltage, over and under frequency, loss of phase, phase sequence wrong),it enters into "mains abnormal delay" and LCD display count down time. When mains abnormal delay is over, it enter into "start delay";
2. LXC6110:Generator enters into "start delay" as soon as "Remote Start on Load" is active;
3. "Start Delay" timer is shown on Status page of LCD.
4. When start delay is over, preheat relay outputs (if this be configured), "preheat start delay XX s" is shown in LCD;
5. When preheat delay is over, fuel relay outputs 1s and then start relay output; if engine crank fails during "cranking time", the fuel relay and start relay deactivated and enter into "crank rest time" to wait for next crank;
6. If engine crank fails within setting times, the controller sends Fail to Start signal and "Fail To Start" message appears on LCD alarm page;
7. In case of successful crank attempt, "safety on timer" starts. During this period, low oil pressure, high water temperature, under speed, charge failure alarms are disabled. As soon as this delay is over, "start idle delay" is initiated (if configured);
8. During "start idle delay", under speed, under frequency, under voltage alarms are inhibited. When this delay is over, "warming up delay" starts (if configured);
9. When "warming up delay" is over, if generator state is normal, its indicator will be illuminated. If voltage and frequency has reached on-load requirements, the closing relay will be energised, generator will accept load, generator power indicator will turn on, and generator will enter Normal Running state; if voltage and frequency are abnormal, the controller will initiate alarm (alarm type will be displayed on LCD alarm page).

6.2. Stopping sequence:



1. LXC6120:when mains return normal during genset running, enters into mains voltage "Normal delay". When mains normal delay are over, enter into "stop delay";

2. LXC6110:When input remote boot failure, began to "stop delay";
3. When stop delay is over, close generator relay is un-energized; generator enters into "cooling time delay". After "transfer rest time", close mains relay is energized. Generator indicator extinguish while mains indicator lights;
4. Idle relay is energized as soon as entering "stop idle delay";
5. If enter "ETS hold delay", ETS relay is energized. Fuel relay is deactivated and decides whether generator is stopped or not automatically;
6. Then enter genset "Fail to stop timer", auto decides whether generator is stopped or not;
7. When the unit is completely stopped, enter the power generation standby mode;If can't stop the alarm controller; (LCD screen displays downtime failure warning) .

6.3. Manual start/stop operation

LXC6120/LXC6110: Press , controller enters into Manual starts mode and its indicator lights. Press , then controller enters into "Manual Test Mode" and its indicator lights. In the both mode, press  to start generator, can automatically detect crank disconnected, and generator accelerates to high-speed running. With high temperature, low oil pressure and abnormal voltage during generator running, controller can protect genset to stop quickly (please refer to No.4~9 of Auto start operation for detail procedures). In "manual mode ", Generator load based on judging the mains is normal, mains is normal, not conversion, load switch mains is unusual, load switch in the power generation side. In "Manual Test Mode ", generator runs well, whether mains normal or not, loading switch must be transferred to generator side.

6.4. Manual start

LXC6120: Press , controller enters into Manual starts mode and its indicator lights. Then press  to start generator, can automatically detect crank disconnected, and generator accelerates to high-speed running. With high temperature, low oil pressure and abnormal voltage during generator running, controller can protect genset to stop quickly (please refer to No.4~9 of Auto start operation for detail procedures). After generator runs well, if remote start signal is active, controller will send closing gens signal; if the remote signal is inactive, controller won't send closing signal.

6.5. Manual stop

Press  can shutdown the running generator. (please refer to No.3~7 of Stopping Sequence for

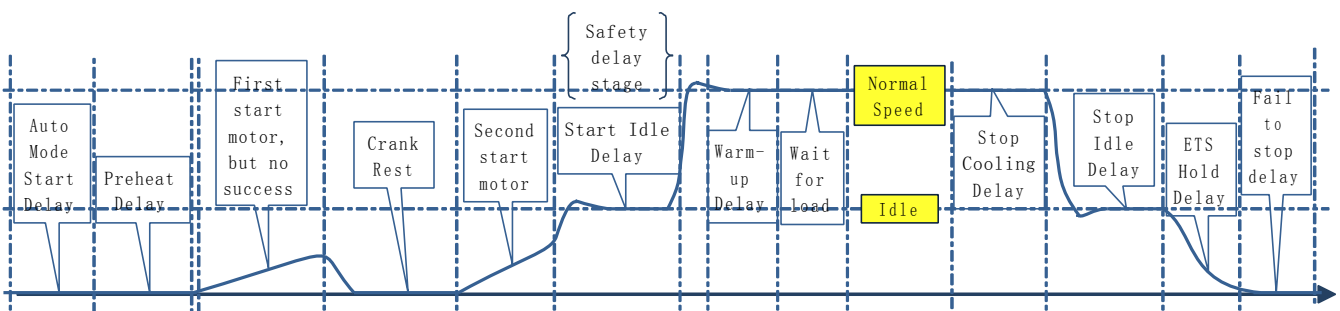

6.6. LXC6120 Switch control procedures

6.6.1. Manual transfer procedures:

When controller is in Manual mode, the switch control procedures will start through manual transfer. Users Can control the loading transfer of ATS via pressing button to switch on or off. But according to the ATS Switch configuration is different, the specific process have some distinction.

❖ " Open breaker detect" is "SELECTD is able"

After the press power close break-brake key, according to the current load case in 2 processes:

1. generator is opened when the generator is load; If the load is closed, the generator is open;
2. Mains is opened when the mains is load; When the end of the sub-gate delay generator closing;

Press mains close or open key, if mains have taken load, will output unload open; If the load is opened, the mains close; If the generator is load, the generator to open, when the end of the open delay, then mains to close.

6.6.2. Auto transfer procedures:

When controller is in Manual Test, Auto or Stop mode, switch control procedures will start through Automatic transfer.

1. Gens to a the mains load, the same principle.

❖ " Open breaker detect" is "SELECT Disable"

1. Mains load is transferred into generator load, after the delay of switch off and transfer interval, generator switch on. Detecting transfer fail while generator switch on. After detecting time up, if switch on fail, then wait for generator switch on. If transfer fail and warning "SEL Enable", there is alarming signal.
2. Gens to a the mains load, the same principle.

6.7. LXC6110 Switch control procedures

6.7.1. Manual transfer procedures:

When controller is in Manual mode, manual transfer will be executive. Users can control switch on or off by pressing key. Press generator switch on or off key, if generator have taken load, will output unload signal; if taken no load, generator will output load signal.

6.7.2. Auto control procedures:

When controller is in manual test, auto or stop mode, switch control procedures will start auto transfer.

❖ If input port is configured as Close Mains Auxillary

1. If "Open breaker detect" is "SELECT Disable"

Gens load is transferred into generator un-load, after the delay of switch off, detecting transfer failure while switch off output. When detecting time up, if switch off failed, to wait for switch off. Otherwise, switch off is completed. Gens unload is transferred into gens load, after the delay of switch on, detecting transfer failure while switch on outputting. When detecting time up, if switch on failed, to wait for switch on. Otherwise, switch on is completed.

If transfer failed and warning "SEL Enable", there is alarming signal whatever switch on or off failure.

2. If "Open breaker detect" is "SELECT Enable" Gens load is transferred into gens unload, after the delay of switch off, switch off is completed. Gens unload is transferred into gens load, after the delay of switch on, detecting transfer failure while switch on outputting. When detecting time up, if switch on failed, to wait for switch on. Otherwise, switch on is completed. If transfer failure warning is "SEL

Enable”, there is warning signal that “switch on fail”.

❖ **If input port is not configured as Close Mains Auxillary**

Gens un-load is transferred into gens load, gens switch on and output.

Gens load is transferred into gens un-load, gens switch off and output.

▲ NOTE:When using ATS of no interposition, switch off detecting is “SELECT Disable”;
When using ATS of having interposition, switch off “SELECT Disable” or “SELECT Enable” both are OK. If choose “SELECT Enable”, switch off output should be configured; When using AC contactor, switch off “SELECT Disable” recommended.

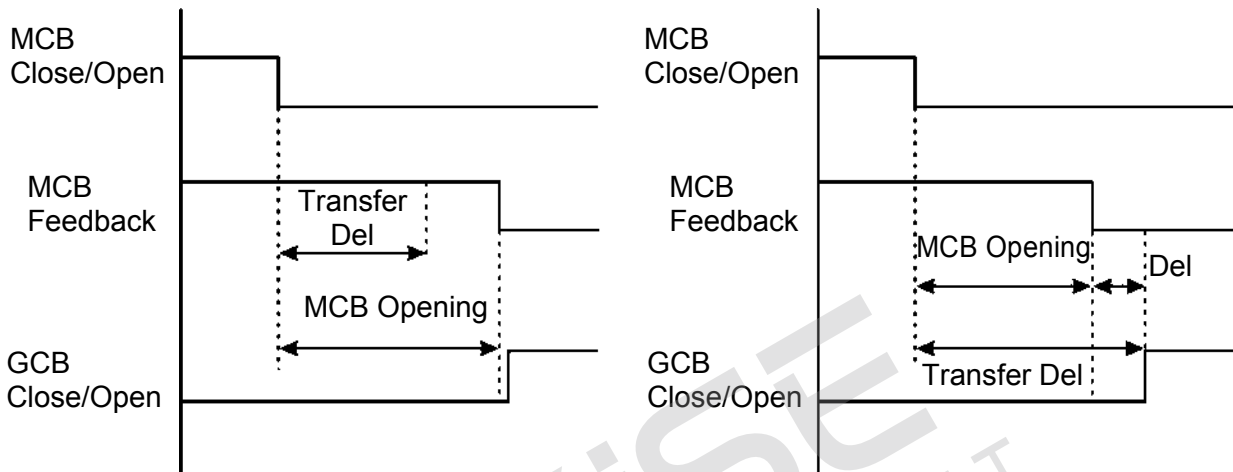

7. SMS Remote control, wireless remote control function description (This feature is limited to rental business version)

GSM Remote control

SMS Code is described as follows

▲ Note:If the operation of the controller, the controller internally set to fly letter phone number can not start with a "+86"

▲ Note:Write text messages are not case sensitive, but must be written in strict accordance with the instructions in the format, the spaces between all the words are a bit of spaces, all commands have to wait until the return code indicates that the operation is valid only.

NO.	SMS Command	SMS return information	Description
1	SMS GENSET	GENSET ALARM	When genset is stopping to alarm
		SYSTEM IN STOP MODE GENSET AT REST	At rest status in stop mode
		SYSTEM IN MANUAL MODE GENSET AT REST	At rest status in stop mode
		SYSTEM IN TEST MODE GENSET AT REST	At rest status in stop mode
		SYSTEM IN AUTO MODE GENSET AT REST	At rest status in stop mode
		SYSTEM IN STOP MODE GENSET IS RUNNING	Running status in stop mode
		SYSTEM IN MANUAL MODE GENSET IS	Running status in stop

		RUNNING	mode
		SYSTEM IN TEST MODE GENSET IS RUNNING	Running status in stop mode
		SYSTEM IN AUTO MODE GENSET AT RUNNING	Running status in stop mode
2	SMS START	GENSET ALARM	Generator is shutdown alarm or trip alarm
		GENSET IS RUNNING	The generator is running
		SMS START INHIBIT	SMS boot prohibited
		STOP MODE NOT START	Cannot start in stop mode
		SMS START OK	Start in manual or auto mode
		AUTO MODE START OK	Can start in auto mode
3	SMS STOP IN AUTO MODE	AUTO MODE STOP OK	In automatic mode shutdown
4	SMS STOP MODE	SMS STOP OK	Set as stop mode
5	SMS MANUAL MODE	SMS MANUAL MODE OK	Set as manual mode
6	SMS TEST MODE	SMS TEST MODE OK	Set as trial test mode
7	SMS AUTO MODE	SMS AUTO MODE OK	Set as auto mode
8	SMS INHIBIT START	INHIBIT START OK	Set as start inhibit
9	SMS PERMIT START	PERMIT START OK	Set as start permit
10	SMS DETAIL	Users check setting (As shown below)	Users can query through a text message multiple generators.

7.1. LXI680 connection diagram

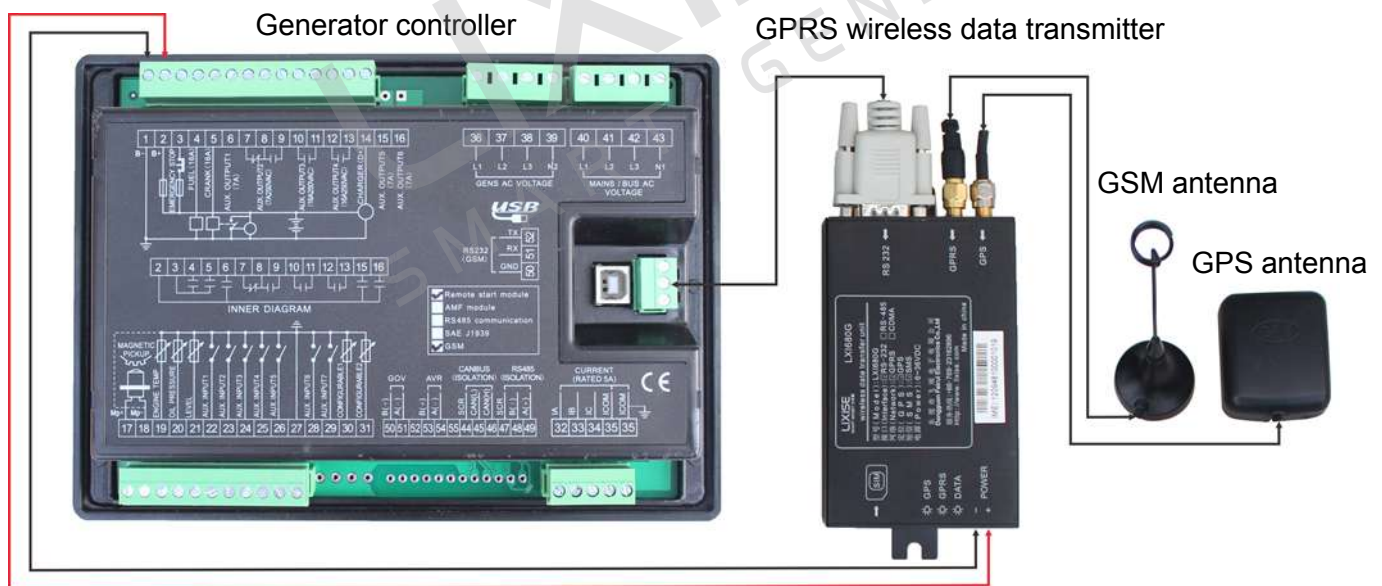

7.2. GSM alarm setting

As show below 【need to the SMS automatically notify the alarm】 When the user check the condition occurs, the DUT module will automatically send SMS to the user set the cell phone number.

GSM Enable

Activate Phone No.

Phone N.O.

Phone N.O.

Phone N.O.

Phone N.O.

Phone N.O.

Description

Please input station info, e.g. 3# gen-sets in the eastern district

Choose Item For Message Informing When Warning

<input type="checkbox"/> Over Speed Warn	<input type="checkbox"/> Maintenance Due Warn	<input type="checkbox"/> Low OP Warn	<input type="checkbox"/> Input2 Warn
<input type="checkbox"/> Under Speed Warn	<input type="checkbox"/> Reverse Power Warn	<input type="checkbox"/> Fuel Open Shutdown	<input type="checkbox"/> Input3 Warn
<input type="checkbox"/> Loss Of Speed	<input type="checkbox"/> Over Power Warn	<input type="checkbox"/> Fuel High Warn	<input type="checkbox"/> Input4 Warn
<input type="checkbox"/> Gens Over Freq Warn	<input type="checkbox"/> ECU Warn	<input type="checkbox"/> Fuel Low Warn	<input type="checkbox"/> Input5 Warn
<input type="checkbox"/> Gens Low Freq Warn	<input type="checkbox"/> Gens Freq Loss Warn	<input type="checkbox"/> Sensor 1 Open Circuit	<input type="checkbox"/> Input6 Warn
<input type="checkbox"/> Gens Over Voltage Warn	<input type="checkbox"/> Gens Reverse Phase Warn	<input type="checkbox"/> Sensor 1 High Warn	<input type="checkbox"/> Input7 Warn
<input type="checkbox"/> Gens Low Voltage Warn	<input type="checkbox"/> ATS Convert Fail	<input type="checkbox"/> Sensor 1 Low Warn	<input type="checkbox"/> Main Normal
<input type="checkbox"/> Over Current	<input type="checkbox"/> Temp Open Shutdown	<input type="checkbox"/> Sensor2 Open Circuit	<input type="checkbox"/> Main Fail
<input type="checkbox"/> Failed To Stop	<input type="checkbox"/> High Temp Warn	<input type="checkbox"/> Sensor2 High Warn	<input type="checkbox"/> Generator Start
<input type="checkbox"/> Charge alternator failure	<input type="checkbox"/> Low Temp Warn	<input type="checkbox"/> Sensor2 Low Warn	<input type="checkbox"/> Generator Stop
<input type="checkbox"/> Bat High Warn	<input type="checkbox"/> Oil Sensor Open Circuit	<input type="checkbox"/> GSM Communicate Fail	<input type="checkbox"/> Mains Onload
<input type="checkbox"/> Bat Low Warn	<input type="checkbox"/> High OP Warn	<input type="checkbox"/> Input1 Warn	<input type="checkbox"/> Gens Onload
<input type="checkbox"/> Not At Auto Mode	<input type="checkbox"/> In Auto Mode		

Choose Item For User's Message Query

<input type="checkbox"/> Works Mode	<input type="checkbox"/> Mains freq	<input type="checkbox"/> Load PF	<input type="checkbox"/> Oil Press(OP)	<input type="checkbox"/> Total Run Hour
<input type="checkbox"/> Mains Volt	<input type="checkbox"/> Gens Freq	<input type="checkbox"/> Battery Volt	<input type="checkbox"/> Fuel Level	<input type="checkbox"/> Engine Status
<input type="checkbox"/> Gens Volt	<input type="checkbox"/> Load KW	<input type="checkbox"/> Charge Volt(D+)	<input type="checkbox"/> Speed	<input type="checkbox"/> Alarm Status
<input type="checkbox"/> Load Current	<input type="checkbox"/> Load kVA	<input type="checkbox"/> Water Temperature(WT)		

7.3. Based on the GPRS DTU remote online monitoring

The scheme is based on LXI680G provide wireless data transmission network, remote control operation of the generator on the Internet; and through the increase in the generator controller LXI680G Room communication protocol, so that the controller can the use of LXI680G SMS via SMS to control the generator run and generators receive alarm SMS.

Remark : LXI680G is **Dongguan Feirui Electronics Co.,Ltd** designed tailor-made for the generator controller wireless data transmission module, in particular to optimize the data exchange between the controller and the DTU, truly a fast and reliable data transmission.

Brief introduction:LXI680G is an industrial grade with GPS global satellite positioning function GPRS DTU product. The product integrates a high-performance, low-power industrial-grade GPS module and GPRS module, GPS global positioning technology and GPRS wireless communication technology the perfect combination of a product.

LXI680G platform based on ARM and embedded operating system, built-in industrial-grade module, it can be used in harsh environments, working temperature range can be up to -40℃ ~ + 85℃.LXI680G provide standard RS232 serial interface, can be quickly and PLC, industrial control, instruments, meters, RTU equipment is linked together, through the GPRS network will be linked to LXI680G equipment data transmission to a host on the Internet, realize the data remote transparent transmission, at the same time to the front-end equipment of GPS location information reported to host, realize positioning of the equipment.

LXI680G with positioning, wireless data communications and data processing capabilities in a compact, rugged, reliable, easy to install, can be widely used in construction, transportation and other industries.

Particularly suitable for tower crane monitoring, heavy machinery management, but also can be used in the field of taxi operations management, transport vehicles, special vehicles, vehicle rental management and leasing.



7.4. Wireless connection schematic diagram

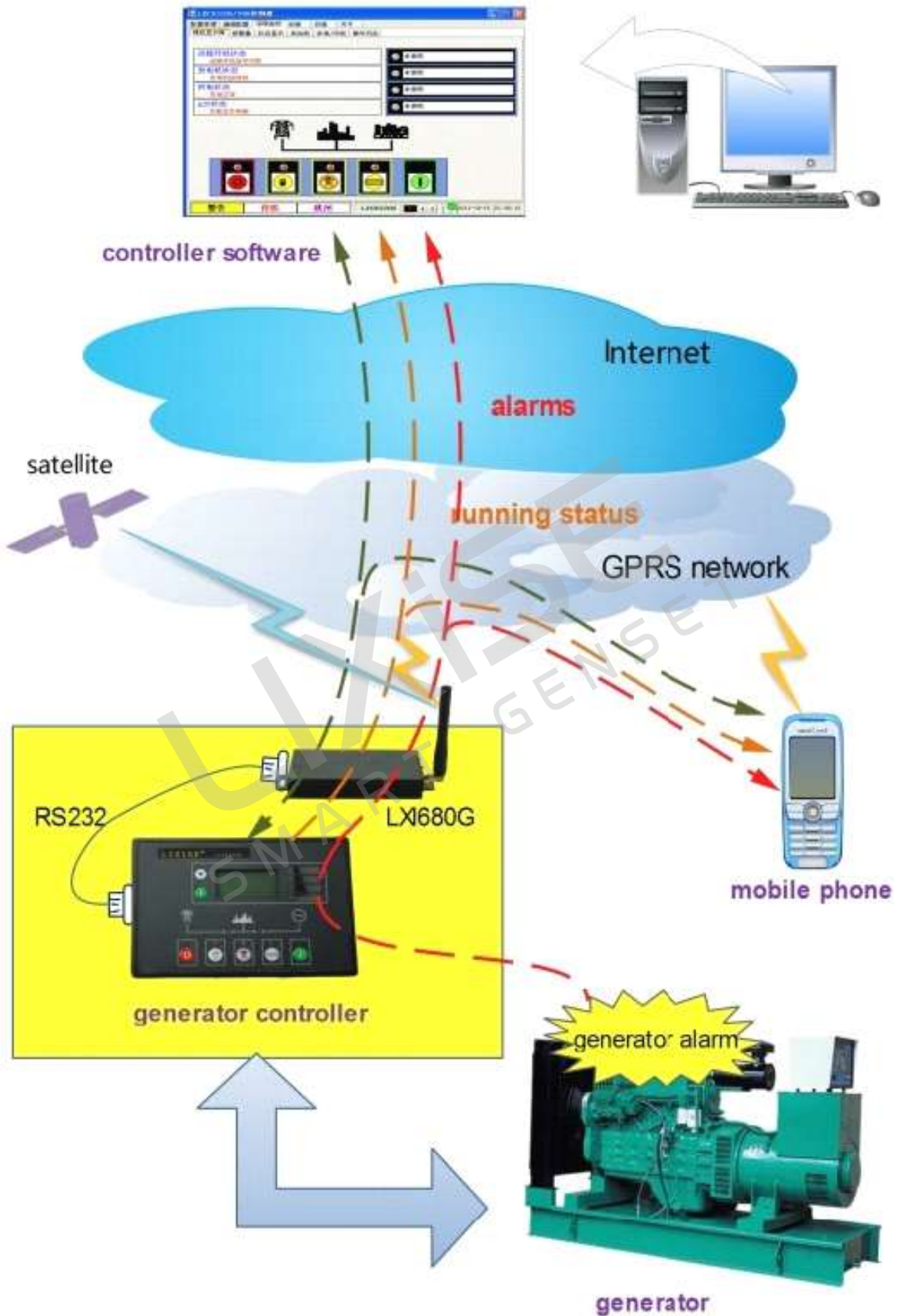

7.5. Connect the controller through the DTU remote

As shown below, Choice in the mode of connection **【 Connected by a data center 】** Can through the Internet remote monitoring state of generator. Details see monitoring software manual.

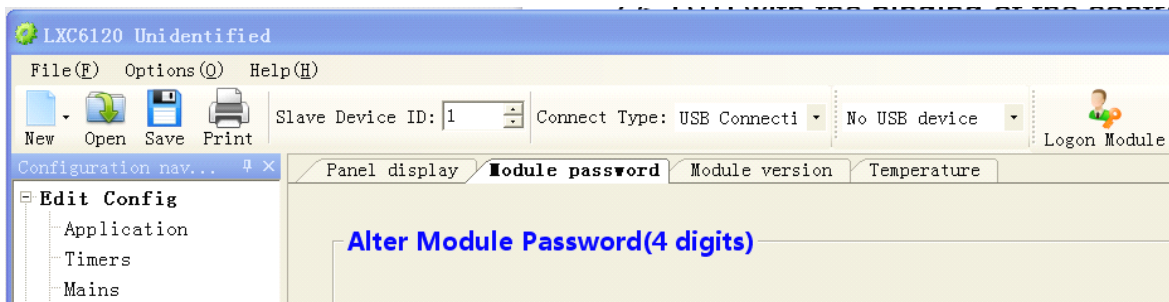

7.6. DTU with the binding of the controller

Controller and LXI680G after binding, it is only through the password to unbundling, if forced the controller and the DTU apart, the controller will record the alarm and displayed on the LCD panel and the warning information, or refuse the next start generator (the user can set up the binding deal) after failure, this feature is especially suitable for generator leasing industry.

7.7. Multilevel password management

Users need to configure the parameters, through different permissions password input, the parameters of the controller will present different configuration interface.

No.	Password type	Extend of competence	Password modification	Unbound	Parameter configuration	Password Managers	Deadline
1	manager	All change permissions (dynamic password Based on the password And the application code For calculating income)				Leasing companies	Long time
2	technician	Only have the parameter Configure permissions (not can unbound)				Leasing Companies Client	Long time
3	Dynamic password	Disposable(only has a one-time password Parameter configure permissions,and unbound)can't change password				Dynamic calculations (Dynamic code Provided by the customer	Certain time effectively

Alter Module Password(4 digits)

New Engineer Pwd:	<input type="text"/>	<input type="button" value="Alter Engineer Pwd"/>
New Technician Pwd:	<input type="text"/>	<input type="button" value="Alter Technician Pwd"/>
New Operator Pwd:	<input type="text"/>	<input type="button" value="Alter Operator Pwd"/>

Generate Dynamic Password

Technician password (4 digits)	<input type="text"/>	
Request code	<input type="text"/>	Dynamic password (Possess the operator priv
<input type="text"/>	<input type="button" value="Generate-->"/>	<input type="text"/>

Enable DTU

If bound DTU was removed:

Alertion

Gens rejects to boot next time

If DTU enabled,look to the left,navigate to tree node "Edit Configuration" -> "GSM" to set SMS options.

8. History query (This feature is limited to rental business version)

8.1. Event log

In the control panel buttons to view controller before abnormal downtime record, including the time of the outage warning content display and the state, the controller can record 142 abnormal downtime record recently.

8.2. Historical alarm data query

Generator controller will fail instantly record all monitoring parameters, users can remotely view or download, user analyze the cause, because a single record of data is very large, the controller can see the main part of the parameters, other parameters need to access via PC connection . If you need remote access monitoring software through GPRS wireless remote access to data.

History data display window



9. Protection

9.1. Shutdown alarm

When controller detects shutdown alarm, it will send signal to stop the generator. Shutdown alarms as following:

No.	Type	Description
1	Emergency Stop	When controller detects emergency stop signal, it will send a stop signal.
2	Over Speed	When controller detects the speed value is higher than the set value, it will send a stop signal.
3	Under Speed	When controller detects the speed value is lower than the set value, it will send a stop signal.
4	Loss Of Speed Signal	When controller detects speed value equals to 0, and the action select "Shutdown", it will send a stop alarm signal.
5	Over Frequency	When controller detects the frequency value is higher than the set value, it will send a stop signal.
6	Under Frequency	When controller detects the frequency value is lower than the set value, it will send a stop signal.

7	Over Voltage	When controller detects the voltage value is higher than the set value, it will send a stop signal.
8	Under Voltage	When controller detects the voltage value is lower than the set value, it will send a stop signal.
9	Fail To Start	If genset start fail within setting of start times, controller will send a stop signal.
10	Over Current	When controller detects the current value is higher than the set value, it will send a stop signal.
11	Maintenance1Shutdown	When count down time is 0 and the action select "Shutdown", it will send a stop alarm signal.
17	Temp. Sensor Open	When controller detects sensor is open circuit, and the action select "shutdown", it will send a stop signal.
18	High Temp Shutdown	When controller detects temperature is higher than the set value, it will send a stop signal.
19	Pressure Sensor Open	When controller detects sensor is open circuit, and the action select "shutdown", it will send a stop signal.
20	Low OP Shutdown	When controller detects oil pressure is lower than the set value, it will send a stop signal.
21	Level Sensor Open	When controller detects sensor is open circuit, and the action select " shutdown", it will send a stop signal.
22	Low Level Shutdown	When controller detects level is lower than the set value, it will send a stop signal.
23	Digital Input Port 1-7	When digital input port 1-7 is set as shutdown, and the action is active, it will send a shutdown signal.
24	D + Open shutdown	Generator starting on the D+ connected to detect if an alarm when open.

9.2. Trip and stop alarm

When controller detects shutdown alarm signal, it will shutdown generator quickly and stop after high speed cooling.

Trip and stop alarm as following:

Trip and stop alarm		
No.	Type	Description
1	Over Current	When controller detects the value is higher than the set value, and the action select "trip and shutdown", it will send trip and stop signal.
2	Maintenance1	When count down time is 0 and the action select "trip and shutdown", it will send a trip and stop signal.
3	Low Fuel	When a trip is generated when the fuel level is low and shut down.
4	Digital Input Ports 1-5	When digital input port1-5 is set as "trip and shutdown", and the action is active, it will send a trip and stop signal.

9.3. Warnings

When controller detects the warning signal, alarm only and not stop genset.

Warnings as following:

Warnings		
No.	Type	Description

1	Over Speed Warn	When controller detects the speed is higher than the set value, it will send warn signal.
2	Under Speed Warn	When controller detects the speed is lower than the set value, it will send warn signal.
3	Loss of Speed Signal Warn	When controller detects the speed is 0 and the action select "Warn", it will send warn signal.
8	Over Current Warn	When controller detects the current is higher than the set value, it will send warn signal.
10	Fail to Stop	When generator not stops after the "stop delay" is over.
11	Charge Alt Fail	When controller detects the charger voltage is lower than the set value, it will send warn signal.
12	Battery Over Voltage	When controller detects the battery voltage is higher than the set value, it will send warn signal.
13	Battery Under Voltage	When controller detects the battery voltage is lower than the set value, it will send warn signal.
14	Maintenance1warn	When count down time is 0 and the action select "Warn", it will send warn signal.
19	Gen Loss of Phase	When controller detects the generator loss phase, it will send warn signal.
20	Gen Phase Sequence Wrong	When controller detects the reverse phase, it will send warn signal.
21	Gen load Close Fail	When the controller gen start closing state input is detected, the default close delay is not detected, the issue of closing failure warning. This warning does not automatically eliminated. (You can press the mute button to eliminate)
22	Main Load Close Fail	When the controller main start opening state input is detected, the default open delay is not detected, the issue of opening failure warning. This warning does not automatically eliminated. (You can press the mute button to eliminate)
23	Gen Load Open Fail	When the controller gen start opening state input is detected, the default open delay is not detected, the issue of opening failure warning. This warning does not automatically eliminated. (You can press the mute button to eliminate)
24	Main Load Open Fail	When the controller main start opening state input is detected, the default open delay is not detected, the issue of opening failure warning. This warning does not automatically eliminated. (You can press the mute button to eliminate)
25	Temp. Sensor Open	When controller detects the sensor is open circuit, and the action select "warn", it will send warn signal.
26	High Temp. Warn	When controller detects the temperature is higher than the set value, it will send warn signal.
28	Oil Pressure Sensor Open	When controller detects the sensor is open circuit, and the action select "warn", it will send warn signal.
29	Low OP Warn	When controller detects the oil pressure is lower than the set value, it will send warn signal.
30	Level Sensor Open	When controller detects the sensor is open circuit, and the action select "warn", it will send warn signal.
31	Low Level Warn	When controller detects the oil lever is lower than the set value, it will send warn signal.
38	Digital Input 1-5Warn	When digit input port 1-5 is set as warning and active, controller sends corresponding warning signal.
45	DTU Bonding Fail	When Set DTU binding, the controller and the DTU communication failure display instructions.

10. Wiring connection

LXC6120 , LXC6110 controller's rear as following:

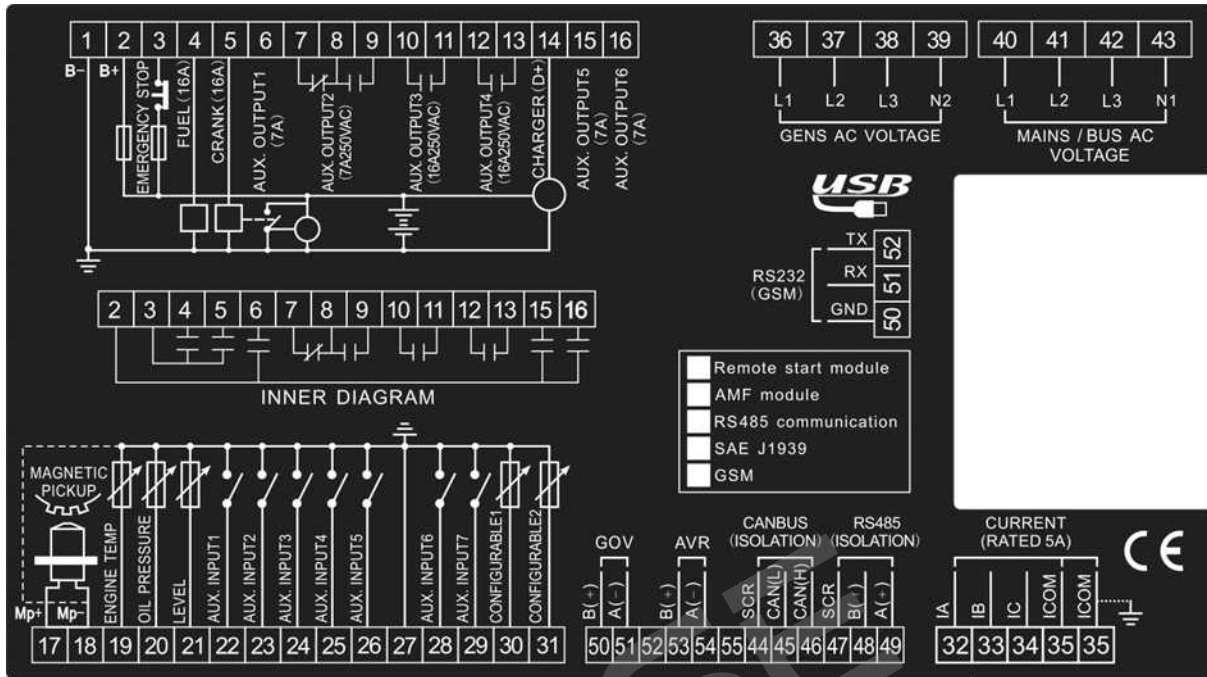

Through control panel is as follows:

No.	Functions	Diameter	Remark
1	DC input B-	2.5mm	DC Power Supply negative input, external starter battery's negative.
2	DC input B+	2.5mm	DC Power Supply positive input of the the external starter battery positive, it is recommended to use 20A fuse.
3	Emergency stop	2.5mm	DC voltage through the emergency stop button connected equipment supplied to the fuel and starter relay output, recommended maximum 30A fuse.
4	Fuel relay output	1.5mm	By the 3-terminal DC voltage supply, rated current 16A
5	Start relay output	1.5mm	By the 3-terminal DC voltage supply, rated current 16A
6	Aux. Output 1	1.5mm	By the B + supply output Rated current 7A
7	Aux. Output 2	1.5mm	Normally closed:Rated current 7A
8			Common point
9			Normally closed:Rated current 7A
10-13	Aux. Output 3-4	2.5mm	Normally open passive contacts of relay, rated 16A, passive contact
14	Charge generator D+ port input	1.0mm	Connected to charging starter s D+ (WL) terminals. If there is no this terminal, and be hung up.
17	Magnetic pickup		Connected to Magnetic Pickup, shielding line is recommended
18	Magnetic pickup input, and controller inner be connected to battery negative.		Common ground, which can be accessed chassis or starter battery negative

19	Temperature sensor input		Connected to temp. Sensor
20	Oil pressure sensor input		Connected to oil pressure sensor
21	Oil level sensor input		Connected to oil level sensor
22-26	Aux input 1-5	1.0mm	Ground connected is active (B-)
27	Public terminals of sensor		Public terminals of sensor, controller inner are connected to battery negative.
32	CT A-phase sensing input	1.5mm	Outside connected to secondary coil of current transformer(rated 5A)
33	CT B-phase sensing input	1.5mm	
34	CT C-phase sensing input	1.5mm	
35	Public terminals of current transformer	1.5mm	
35	Public terminals of current transformer	1.5mm	
36	Genset A-phase Voltage sensing input	1.0mm	Connected to A-phase output of genset (2A fuse is recommended)
37	Genset B-phase Voltage sensing input	1.0mm	Connected to B-phase output of genset (2A fuse is recommended)
38	Genset C-phase Voltage sensing input	1.0mm	Connected to C-phase output of genset (2A fuse is recommended)
39	Genset N-wire input	1.0mm	Connected to output N-wire of genset
40	Mains A-phase voltage sensing input	1.0mm	Connected to A-phase of mains (2A fuse is recommended) (LXC6110without)
41	Mains B-phase voltage sensing input	1.0mm	Connected to B-phase of mains (2A fuse is recommended) (LXC6110without)
42	Mains C-phase voltage sensing input	1.0mm	Connected to C-phase of mains (2A fuse is recommended) (LXC6110without)
43	Mains N-wire input	1.0mm	Connected to output N-wire of mains(LXC6110 without)
47	RS485 screen	0.5mm	Impedance-120Ω shielding wire is recommended, its single-end earthed. (controllers without RS485 don't have this terminal)
48	RS485-	0.5mm	
49	RS485+	0.5mm	
50	RS232 Public land	0.5mm	It is recommended to use shielded wire, shielding layer of single-end grounding (no SMS function controller is the terminal)
51	RS232 RX	0.5mm	
52	RS232 TX	0.5mm	

















Back panel terminal block wiring description:

✧ **NOTE:** Back USB interface for programming interface parameters, can be directly using a computer programming of the USB cable to the controller, the controller without external power supply.

 **NOTE:** Prohibited during operation of the engine starter batteries removed, otherwise it will cause the control system due to excessive DC input voltage and burned!

11. Parameters setting

11.1. Advanced configuration parameters

In the controller main interface under long press button for  3 seconds, enter the password input interface, press  or  key to enter the corresponding bit password(0-9), press   shift, after the completion of the input  proofreading password, the password is correct according to the different permissions password to enter the main interface of the parameters of the different permissions, the password error exit. (The factory default password is: 0000) The factory default password the user can modify. Press  and  keys can flip up and down the parameters configuration screen operation, under the currently selected configuration parameter, press the  key, to the current configuration mode parameters, the current value of the first black display, press  or  keys for the bit value adjustment, press   key to shift, press the  keys to confirm the Settings. This value is permanently saved to the internal FLASH controller. Configuration process, press  to return to the previous menu or long press  to exit the configuration menu to return to the main screen.

Sequence Number	Items	Range	Default	Description	
The timer Settings	1	Start Delay	(0-3600)s	1	Time from mains abnormal or remote start signal is active to start genset.
	2	Stop Delay	(0-3600)s	1	Time from mains normal or remote start signal is deactivated to genset stop.
	3	Preheat Delay	(0-300)s	0	Power-on time of heater plug before starter is powered up.
	4	Cranking Time	(1-60)s	8	Power-on time of starter.
	5	Crank Rest Time	(3-60)s	10	The waiting time before second power up when engine start fail.
	6	Safety On Delay	(1-60)s	10	Alarms for low oil pressure, high temperature, under speed, under frequency/voltage, charge alt failure are inactive.
	7	Start Idle Time	(0-3600)s	0	Idle running time of genset when starting.
	8	Warming Up Time	(0-3600)s	10	Warming time between genset switch on and high speed running.
	9	Cooling Time	(3-3600)s	10	Radiating time before genset stop, after it unloads.
	10	Stop Idle	(0-3600)s	0	Idle running time when genset stop.
	11	ETS Solenoid Hold	(0-120)s	20	Stop electromagnet's power on time when genset is stopping.
	12	Fail to Stop Delay	(0-120)s	0	Time between ending of genset idle delay and stopped when "ETS time" is set as 0; Time between ending of ETS hold delay and stopped when "ETS time" is not 0.
	13	Transfer Time	(0-99.9)s	1.0	Interval time from mains switch off to generator switch on; or from generator switch off to mains switch on.

	14	Close Time	(0-100.0)s	5	Pulse width of mains/generator switch on.
Engine set	1	Rated Speed (0-6000RPM)	(0-6000RPM)	1500	Offer standard to judge over /under/ loading speed.
	2	Magnetic Pickup	Enable/Disable	Enable	
	3	Flywheel Teeth	(5-300)	118	Tooth number of the engine, for judging of starter crank disconnect conditions and inspecting of engine speed. See the installation instructions.
	4	Start number	(1-10)	3	Maximum crank times of crank number. When reach this number, controller will send start failure signal.
	5.1	Loss of Speed Signal	(0-20.0)s	3.0	If the set value is 0, only warning and not to shutdown the generator.
	5.2	Loss of Speed Action	Warning/Shutdown	Warning	
	5.3	Under Speed	(0-6000)RPM	1200	When engine speed has fallen below the set value for 10s, Under Speed is active. It will initiate a shutdown alarm signal.
	5.4	Over Speed	(0-6000)RPM	1710	When engine speed has exceed the set value for 2s, Over Speed is active. It will initiate a shutdown alarm signal.
	5.5	Charge Alt Failure (Warning)	(0-30)V	6	During generator is normal running, when alternator D+(WL) voltage has fallen below the set value and remains for 5s, It will initiate a shutdown alarm signal. (Return value is 1V)
	5.6	Battery Over Voltage (Warning)	(12-40)V	33	When battery voltage has exceeds the set value and remains for 20s, It will initiate a warning alarm signal. Only warning and not to shutdown the generator. (Return value is 1V)
	5.7	Battery Under Voltage (Warning)	(4-30)V	8	When battery voltage has fallen below the set value and remains for 20s, It will initiate a warning alarm signal. Only warning and not to shutdown the generator. (Return value is 1V)
	6.1	Crank Disconnect	(0-8)	6	There are 3 conditions of disconnecting starter with engine. Each condition can be used alone and simultaneously to separating the start motor and genset as soon as possible.
	6.2	Disconnect Engine Speed	(0-3000)RPM	360	When engine speed higher than the set value, starter will be disconnected.
	6.3	Disconnect Generator Freq	(10.0-30.0)Hz	14	When generator frequency higher than the set value, starter will be disconnected.
	6.4	Disconnect Oil Pressure	(0-400)kPa	200	When generator oil pressure higher than the set value, starter will be disconnected.
6.5	D+ Disconnect	(3.0-32.0)V	8	When generator D+ higher than the set value, starter will be disconnected.	
The generator set	1	Gen Rated Volt	(30-620V)	230	Offer standards for detecting of gens' over/under voltage and loading volt.
	2	Gen Rated Freq	(10-65Hz)	50	Offer standards for detecting of over/ under /load frequency.
	3	Rated Current	(5-6000)A	500	Generator's rated current, standard of load current.
	4	Curr Transform	(6000/5A)	500	The change of external connected CT.

	5	Gen AC System	(0-3)	0	0: 3P4W; 1: 2P3W; 2: 1P2W; 3: 3P3W
	6	Gen Poles	(2-16)	4	
	7.1	Gen Volt Delay	(0-20.0)s	10	The alarm delay of generator over voltage and under voltage.
	7.2	Gen Over Volt Option	Enable/Disable	Enable	
	7.3	Gen Over Voltage Trip	(30-620)V	264	When generator voltage has exceed the set value and the "Gen abnormal delay" has expired, Gen Over Voltage is active.
	7.4	Gen Under Volt Option	Enable/Disable	Enable	
	7.5	Gen Under Voltage Trip	(30-620)V	196	When generator voltage has fallen below the set value and the "Gen abnormal delay" has expired, Gen Under Voltage is active.
	7.6	Gen Under Frequency Option	Enable/Disable	Enable	
	7.7	Gen Under Frequency Trip	(0-75.0)Hz	45	When generator frequency has fallen below the set value but Not equal to 0 for 10s, Under Frequency is active. It will initiate a shutdown alarm signal.
	7.8	Gen Over Frequency Option	Enable/Disable	Enable	
	7.9	Gen Over Frequency Trip	(0-75.0)Hz	57	When generator frequency has exceed the set value for 2s, Over Frequency is active. It will initiate a shutdown alarm signal.
	8.1	Over Current Trip	(50-130)%	120	When the load current has exceed the set value, "over current" delay is initiated.
	8.2	Over Current Delay	(0-3600)s	1296	When load current has exceed the set value and the "over current" delay has expired, over current is initiated.
	8.3	Over Current Action	Warning/Shutdown/ELE Trip	Warning	
Grid set	1	Mains Rated Volt	(30-620V)	230	Offer standards for detecting of mains' over/under voltage and loading volt.
	2	Mains Normal Delay	(0-3600)s	10	The time from mains abnormal to normal or from normal to abnormal; suitable for ATS (automatic transfer switch).
	3	Mains Abnormal Delay	(0-3600)s	5	
	4	Mains Under Volt Alarm Option	Enable/Disable	Enable	
	5	Mains Under Voltage	(30-620)V	184	When mains voltage has fallen below the set value, Mains Under Voltage is active. (delay of 1 second)
	6	Mains Over Volt Alarm Option	Enable/Disable	Enable	
	7	Mains Over Voltage	(30-620)V	276	When mains voltage has exceed the set value, Mains Over Voltage is active. (delay of 1 second)
Gen set	1.1	Temp Sensor Curve	(0-12)	1	VDO120C

	1.2	Temperature Sensor Open	No/warning/downtime	Warning	Indication location is displayed on LCD screen liquid level sensor is shown as "+ + +".
	1.3	High Temp Option	Can make/ban	Can make	
	1.4	High Temperature	(80-140)°C	98	When the temperature value of the external temperature sensor exceeds the set value, high temperature signal is sent. Detecting only after safety on delay is over. (this only concerns external temperature sensor, not high temperature signal via configuration. input port).
	1.5	High Temperature Action	Warning/downtime	Warning	Factory defaults to: when the temperature is too high, alarm shutdown, function as shown in the note a
	2.1	Oil Pressure Sensor Curve	(0-9)	1	VDO
	2.2	Oil Pressure Sensor Open	None/Warning/Shutdown	Warning	0: Never (temperature sensor will show "+++"); 1: Warning; 2:Shutdown
	2.3	Low Oil Option	Enable/Disable	Enable	
	2.4	Low Oil Pressure Trip	(0-400) KPa	103	When the external pressure sensor value falls below this set value, low oil pressure signal is sent. Detecting only after safety on delay is over.
	2.5	Low Oil Pressure Action	Warning/Shutdown	Warning	0: Warning 1: Shutdown.
	3.1	Fuel Sensor Curve	(0-9)	1	VDO
	3.2	Fuel Sensor Open	None/Warning/Shutdown	Warning	Indication location is displayed on LCD screen liquid level sensor is shown as "+ + +".
	3.3	Fuel Low Option	Enable/Disable	Enable	
	3.4	Fuel Low Trip	(0-100)%	10	
	3.5	Fuel Low Action	Warning/Shutdown	Warning	0: Warning 1: Shutdown.
	3.6	Pump Turn on Trip	(0-100)%	25	
	3.7	Pump Turn off Trip	(0-100)%	80	
Input port Settings	1.1	Digital Input 1 Type	(0-29)		Factory default: High Temperature Input
	1.2	Digital Input 1 Active	(0-1)	0	Factory default: Close to active
	1.3	Digital Input 1 Action	(0-3)		Never/ Warning /Shutdown
	1.4	Digital Input 1 Period	(0-3)		Never/From safety on/From Crank/Away.
	1.5	Digital Input 1 Delay	(0-20.0)s		
	2.1	Digital Input 2 Type	(0-29)		Factory default: Low Oil Pressure Warning Input.

	2.2	Digital Input 2 Active	(0-1)		Factory default: Close to active.
	2.3	Digital Input 2 Action	(0-3)		
	2.4	Digital Input 2 Period	(0-3)		
	2.5	Digital Input 2 Delay	(0-20.0)s		Delay output function.
	3.1	Digital Input 3 Type	(0-29)		Factory default: Remote Start.
	3.2	Digital Input 3 Active	(0-1)		Factory default: Close to active.
	3.3	Digital Input 3 Action	(0-2)		
	3.4	Digital Input 3 Period	(0-3)		
	3.5	Digital Input 3 Delay	(0-20.0)s		
	4.1	Digital Input 4 Type	(0-29)		Factory default: Fuel level Warning
	4.2	Digital Input 4 Active	(0-1)		Factory default: Close to active
	4.3	Digital Input 4 Action	(0-3)		
	4.4	Digital Input 4 Period	(0-3)		
	4.5	Digital Input 4 Delay	(0-20.0)s		
	5.1	Digital Input 5 Type	(0-29)		Factory default: Cool Level Warning
	5.2	Digital Input 5 Active	(0-1)		Factory default: Close to active
	5.3	Digital Input 5 Action	(0-2)		
	5.4	Digital Input 5 Period	(0-3)		
	5.5	Digital Input 5 Delay	(0-20.0)s		
Output Settings	1	Choose 1 programmable output function	(0-30)		Factory defaults to: fuel relay output.
	2	Choose 2 programmable output function	(0-30)		The factory default is: electrical outages.
	3	Choose 3 programmable output function	(0-30)		The factory default is: the idle speed control.

	4	Choose four programmable output function	(0-30)		Factory defaults to: power switch.
Module Settings	1	The controller information	The factory information		The controller factory information
	2	Language selection	English/Chinese/Spanish/Russian	English	
	3	On choosing	(0-2)	0	Manual mode 0: stop pattern 1:2: automatic mode
	4	The controller address	(1-247)	1	The controller address
	5	Maintenance of alarm	Can make/ban	ban	Maintenance alarm can make setting options.
	6	Maintenance time (1-5000 hours)	(1-5000)h	30	Used to set the time of maintenance intervals
	7	Maintenance time to action	(1-3)	1	1 warning; 2 stop tripping outage 1 warning; 2 stop tripping outage
	8	Date of the module			After the date of module, the user can set the power down time is automatically updated.
	9	The module of time			Module, users can set the time when the power is automatically updated.
	10	The technician password	(0-9999)	0000	Can view and modify configuration.
	11	The operator password	(0-9999)	1111	Can only view the configuration, without permission to modify.

11.2. Defined contents of configurable input ports

No.	Type	Description
1	Users Configured	Including following functions: ----- Warning: warn only, not shutdown. Shutdown: alarm and shutdown immediately. Trip and stop: alarm, generator unloads and shutdown after hi-speed cooling. Trip: alarm, generator unloads but not shutdown. Indication: indicate only, not warning or shutdown. ----- From safety on: detecting after safety on run delay. From crank: detecting as soon as start. Always: input is active all the time. Never: input inactive
2	Alarm Mute	Can prohibit "Audible Alarm" output when input is active.
3	Reset Alarm	Can reset shutdown alarm and trip alarm when input is active.
4	High Temp Shutdown	When the generator is running in safe delay closing the digital input, delay 5 seconds after shutdown alarm
5	Low Oil Shutdown	When the generator is running in safe delay closing the digital input, delay 3 seconds after shutdown alarm
6	Auxiliary Warning	When the generator is running any safe closing the digital input, delay

		2 seconds after shutdown alarm
7	Auxiliary Shutdown	When the generator is running any safe closing the digital input, delay 2 seconds after shutdown alarm
8	Fuel Level Warning	When the generator is running any safe closing the digital input, delay 15 seconds after shutdown alarm
9	Fuel Level Shutdown	When the generator is running any safe closing the digital input, delay 15 seconds after shutdown alarm
10	Cool Level Warning	When the generator is running any safe closing the digital input, delay 15 seconds after shutdown alarm
11	Cool Level Shutdown	When the generator is running in safe delay closing the digital input, delay 15 seconds after shutdown alarm
12	Inhibit High Temp Stop	When the closed digital input, generator is running with load, temperature input is higher than the shutdown threshold, no shutdown alarm.
13	Inhibit Low Oil Stop	When the closed digital input, generator is running with load, oil pressure input is lower than the shutdown threshold, no shutdown alarm.
14	Inhibit Alarm Stop	
15	Remote Start On Load	In Auto mode, when input is active, genset can be started and without load after genset is OK; when input is inactive, genset will stop automatically.
16	Manual Start	In Auto mode, when input active, genset will start automatically; when input inactive, genset will stop automatically.
17	Panel Lock	In Auto mode, during generator normal running, when input is active, inhibit generator shutdown automatically.
18	Inhibit Auto Stop	In Auto mode, during generator normal running, when input is active, inhibit generator shutdown automatically.
19	Inhibit Auto Start	In Auto mode, inhibit generator start automatically when input is active.
20	Instrument Mode	All outputs are prohibited in this mode.
21	Gens Closed Auxiliary	Connect generator loading switch's Aux. Point.
22	Mains Closed Auxiliary	Connect mains loading switch's Aux. Point.
23	Simulate Stop Key	An external button can be connected and pressed as simulate panel.
24	Simulate Manual Key	
25	Simulate Test Key	
26	Simulate Auto Key	
27	Simulate Start Key	
28	Simulate Gens Load Key	
29	Simulate Mains Load Key	
30	Not Used	Do not activate any function

11.3. Enable definition of programmable output ports

No.	Type	Description
0	Not Used	
1	Fuel Relay	Action before the starter motor, open the fuel system in advance. Usually controls the governor's power and fuel solenoid valve.
2	Crank Relay	When starting the motor action, often connected to the starter relay.
3	Air Flap	Action in over speed alarm stop and emergence stop. It also can close the air inflow the engine.
4	Audible Alarm	Action in warning, shutdown, trips. Can be connected outside alarm. When programmable input port is active of "alarm mute", can prohibit its output.

5	Louver Control	Action in genset starting and disconnect when genset stopped completely.
6	Fuel Pump Control	It is controlled by fuel pump of level sensor's limited threshold.
7	Ahead Fuel Output	It is controlled by heating of temperature sensor's setting bound.
8	Excite Generator	It is controlled by cooler of temperature sensor's setting bound.
9	Pre-lubricate	Action from "crank on" to "safety on".
10	Preheat (Before Crank)	From the "preheat" to "open the fuel" are activated the output end of the period
11	Preheat (Until End Of Crank)	From the "preheat" to "until end of crank" are activated the output end of the period
12	High Speed Control	From the "warm-up delay" to "cool delay" are activated the output end of the period
13	Idle Control	Used for engine which has idles. Pull in before starting and pull out after into hi-speed warming; Pull in during stopping idle mode and pull out after shutdown completed.
14	Raise Speed	Action in hi-speed warming run.
15	Drop Speed	Action in period of stop idle mode to time of wait for stopping completely.
16	ETS Control	Used for engines with ETS electromagnet. Pull in when stop idle is over and pull out when set "ETS delay" is over.
17	Close Generator	Generator load conditions are ripe for action, control power closing switch with load. It is a continuous output.
18	Close Generator Pulse	The same role, but is not a continuous output, but only the output pulses of a preset time. This time set in the timer configuration.
19	Open Breaker	Gens whether or mains is opened, will be output. It is a common sub-gate output.
20	Close Mains	Control switch of mains is load.
21	Close Mains pulse	
22	Generator Available	Action in period of gens normal to hi-speed cooling.
23	In Stop Mode	
24	In Manual Mode	
25	In Manual Test Mode	
26	In Auto Mode	
27	Common Alarm	Action in gens common warning, common shutdown, common trips alarm.
28	Battery High Volts	An action in battery's over voltage warning alarm.
29	Battery Low Volts	Action in battery's low voltage warning alarm.
30	Charge Alt Failure	Action in charge alt fail warning alarm.

11.4. Sensor selection list

Temperature Sensor	Oil Pressure Sensor	Level Sensor
0 Not used	0 Not used	0 Not used
1 VDO 120°C	1 VDO0-10BAR	1 VDO 0-180ohm
2 CURTIS	2 CURTIS	2 SGD
3 VOLVO-EC	3 VOLVO-EC	3 SGH
4 DATCON	4 DATCON 10BAR	4 Custom Res Curve
5 SGX	5 SGX	5 Custom 4-20mA curve

6	SGD	6	SGD	6	Reserved
7	SGH	7	SGH	7	Reserved
8	PT100	8	Custom Res Curve	8	Reserved
9	Custom Res Curve	9	Custom 4-20mA curve	9	Reserved
10	Custom 4-20mA curve	10	Reserved	10	Reserved
11	Reserved	11	Reserved	11	Reserved
12	Reserved	12	Reserved	12	Reserved

11.5. Pressure unit conversion table

Unit	N/m ² Pa	kg/cm ²	bar	1b/in ² .psi
1Pa	1	1.02 × 10 ⁻⁵	1 × 10 ⁻⁵	1.45 × 10 ⁻⁴
1kgf/cm ²	9.8 × 10 ⁴	1	0.98	14.2
1Bar	1 × 10 ⁵	1.02	1	14.5
1Psi	6.89 × 10 ³	7.03 × 10 ⁻²	6.89 × 10 ⁻²	1

NOTE:

1. Is there a difference if standard curve of sensor with the use of sensors, can be change by itself in the custom curve, when the sensor selection is "no", the curve of sensor doesn't work.
2. If the corresponding sensors, only alarm switch, is the sensor must be set to "no", otherwise likely stop alarm or warning.

11.6. Conditions of crank disconnect selection

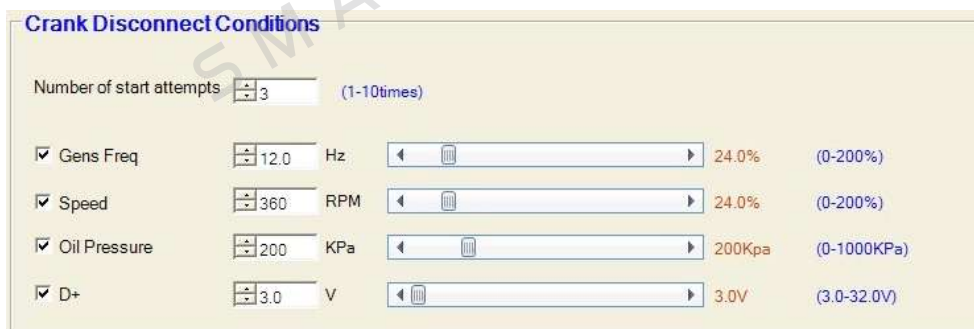

As shown above, check the desired options, multiple choice or do not choose.

1. There are 4 conditions to make starter disconnected with engine, that is, speed sensor, generator frequency, Charge D+ and engine oil pressure. They all can be used separately. We recommend that engine oil pressure should be using with speed sensor and generator frequency together, in order to make the starter motor is separated with engine immediately and can check crank disconnect exactly.
2. Speed sensor is the magnetic equipment which be installed in starter for detecting flywheel teeth.
3. When set as speed sensor, must ensure that the number of flywheel teeth is as same as setting, otherwise, "over speed stop" or "under speed stop" may be caused.

4. If genset without speed sensor, please don't select corresponding items, otherwise, "start fail" or "loss speed signal" maybe caused.
5. If genset without oil pressure sensor, please don't select corresponding items.
6. If not select generator in crank disconnect setting, controller will not collect and display the relative power quantity (can be used in water pump set); if not select speed sensor in crank disconnect setting, the rotating speed displayed in controller is calculated by generator frequency and number of poles.
7. If the generator without magnetoelectric sensor and Oil pressure sensor, the "Charger D+" is optional as a starter motor separation conditions. It is recommended to select "Oil Pressure+ Charger D+" for safety.

LIXISE
SMART GENSET

12. Typical application

1. Three kinds of remote controllers recommended **Dongguan Feirui Electronics Co.,Ltd** ,wireless data transmission equipment DTU680G ,The product has a wireless data transmission, GPS location data, as long as there is cell phone signal can be transmitted through the mobile phone network, innovation and independent R & D,dedicated communication module, an infinite distance, data security and reliability features.
2. If the engine starter battery voltage is 24V, measuring starter output port, output port and stop the fuel outlet (based on user configuration dependent) on the battery negative resistance should not be less than 2 ohms, if less than 2 ohms in the corresponding current output port another extension greater than 30A relay. If the engine starter battery voltage of 12V, output measurement start, fuel output port and output port shutdown on battery negative resistance should not be less than 1 ohm, if less than 1 ohm in the corresponding output current is greater than another extension 30A relay.

Three-phase three-wire connection wiring diagram(to LXC6120 example)

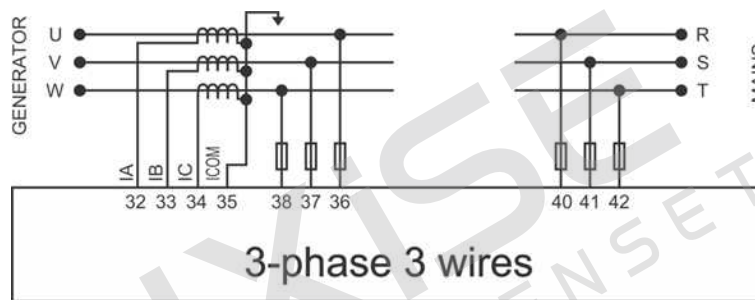

Single-phase two-wire connection wiring diagram(to LXC6120 example)

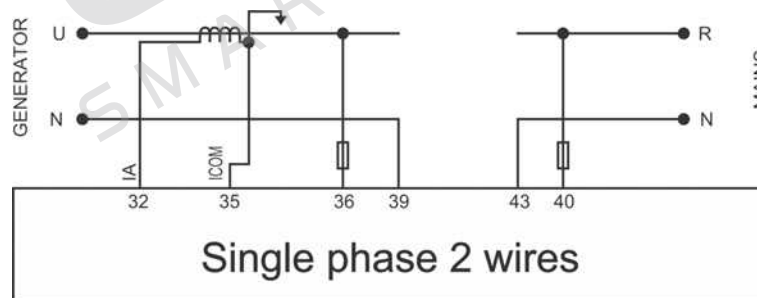

Two-phase three-wire connection wiring diagram(to LXC6120 example)

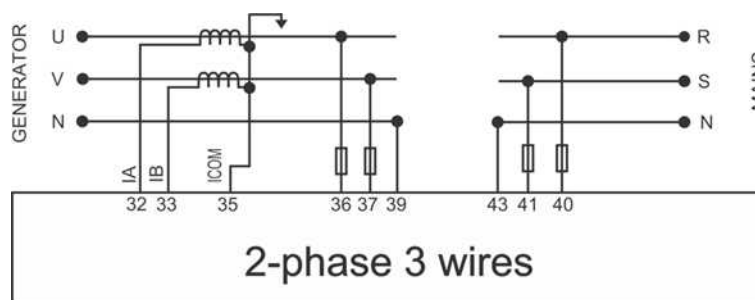

LXC6110 Typical application diagram

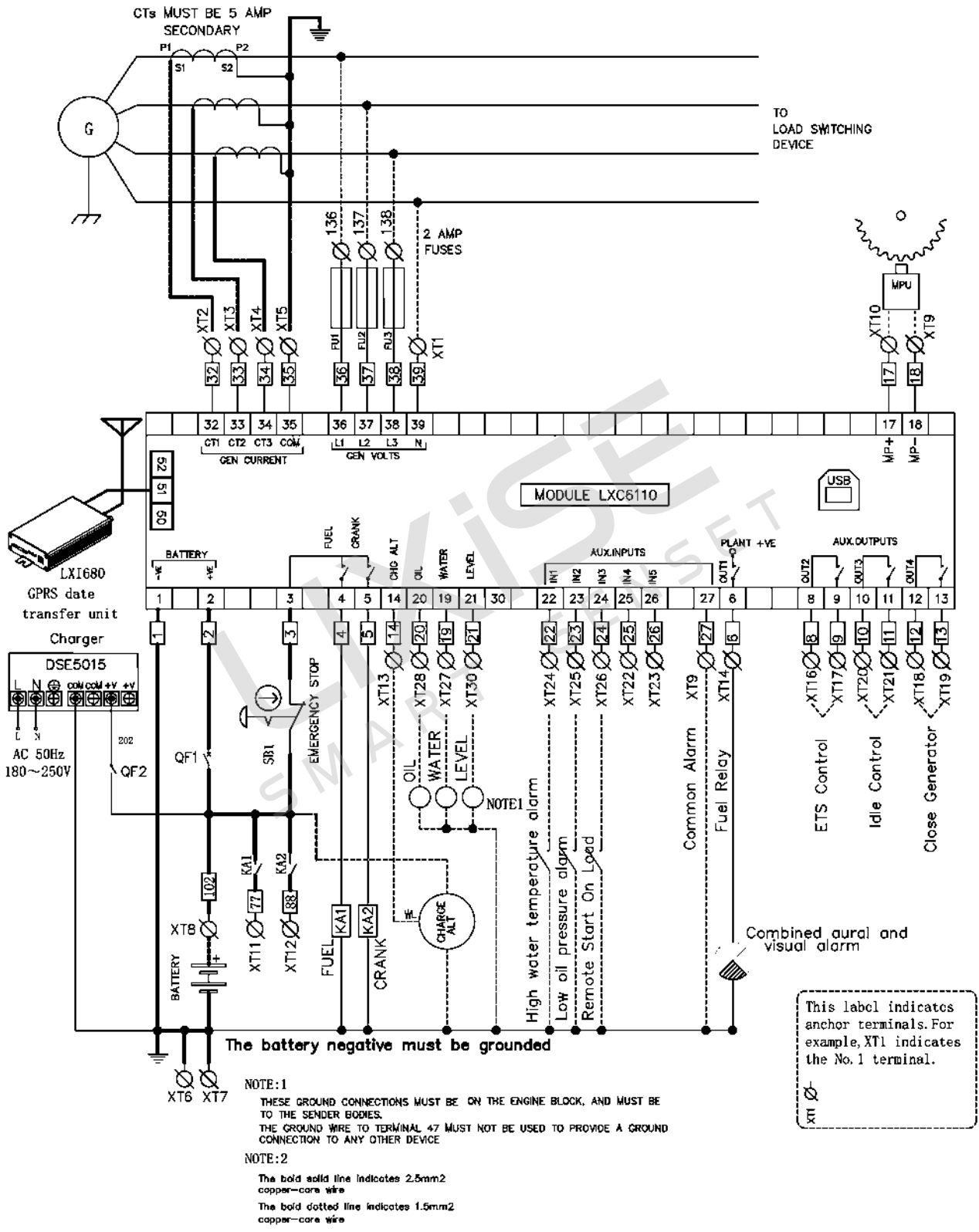

LXC6120 Typical application diagram

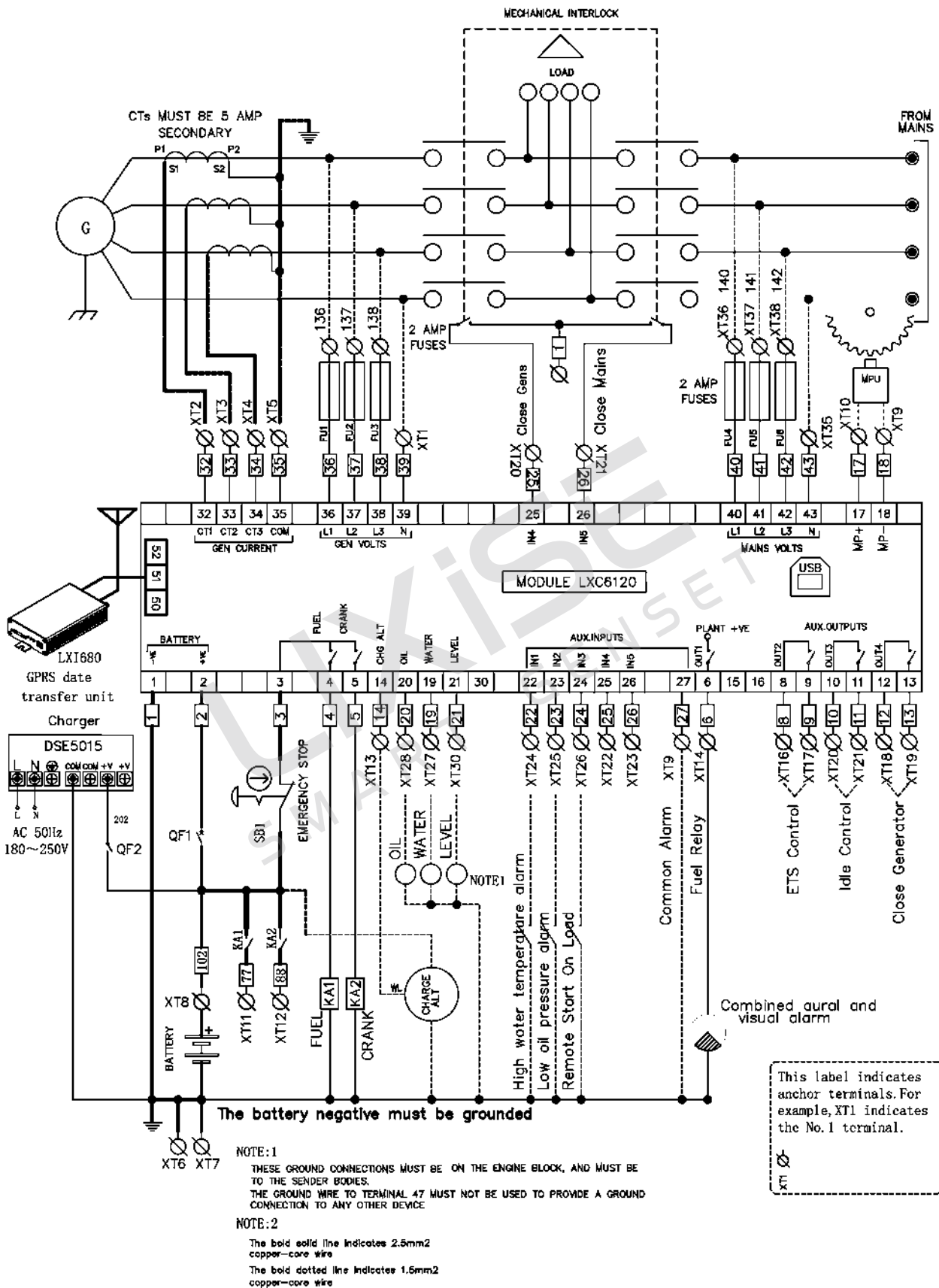

13. Installation

LXC61X0 Controller is panel built-in design; it is fixed by clips when installed. The controller's overall dimensions and cutout dimensions for panel, please refers to as following.

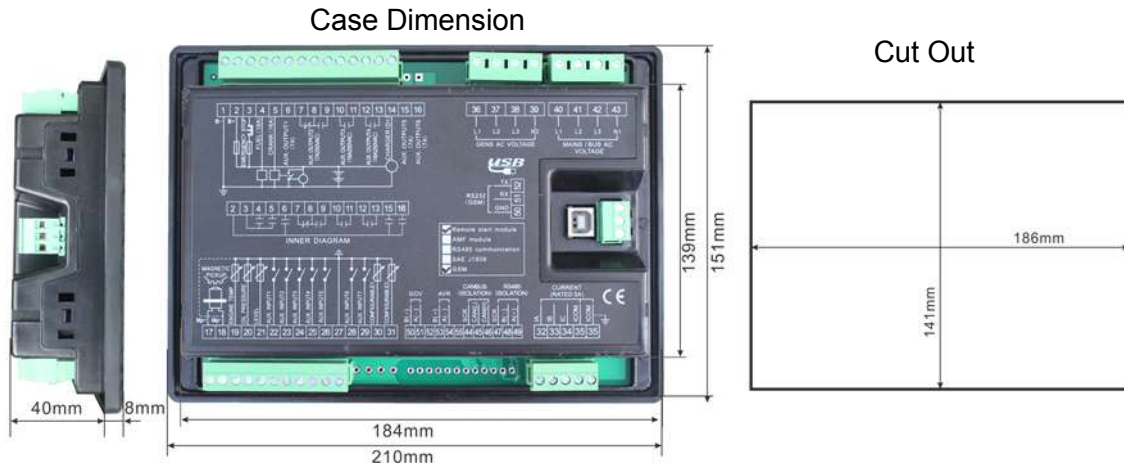

This section contains a number of very important considerations.

Controller installation instructions notes			
NO.	Item	Note,Warning, Caution	Description
1	Voltage Input	:8~35VDC	Negative of battery must be connected with the shell of starter stable.
2	Connect controller to battery	:Wire $\geq 2.5\text{mm}^2$	The diameter of wire which from power supply to battery must be over 2.5mm ² .
3	Battery Charger	:Charger must be connected directly to the battery.	Please firstly connect output wires of charger to battery's positive and negative directly, then, connect wires from battery's positive and negative to controller's positive and negative input ports in order to prevent charge disturbing the controller's normal working.
4	Speed Sensor Input	:2 cores shielding line	Speed sensor is the magnetic equipment which be installed in starter and for detecting flywheel teeth.Its connection wires to controller should apply for 2 cores shielding line. The shielding layer should connect with No.18 terminal in controller while another side is hanging in air.The else two signal wires are connected with No.17 and No.18 terminals in controller.The output voltage of speed sensor should be within (1~24) VAC (effective value) during the full speed.
5	Output And Expand Relays	:Please add freewheel diode to both ends of expand relay's coils or,increase resistance-capacitance return circuit	All outputs of controller are relay contact output type.If need to expand the relays, please add freewheel diode to both ends of expand relay's coils (when coils of relay has DC current) or, increase resistance-capacitance return circuit (when coils of relay has AC current), in order to prevent disturbance to controller or others equipment.
6	AC Input	:ICOM port must be connected to negative pole of battery controller power. :When there is load current, transformer's secondary side prohibit from open circuit.	Current input of controller must be connected to outside current transformer.And the current transformer's secondary side current must be 5A. At the same time, the phases of current transformer and input voltage must correct. Otherwise, the current of collecting and active power maybe not correct.

7	Withstand Voltage Test	 :When controller had been installed in control panel, if need the high voltage test, please disconnect controller's all terminal connections, in order to prevent high voltage into controller and damage it.
---	------------------------	---



14. Common faults and exclusion

Following in my controller process more common failure and troubleshooting, if there is a failure of the other can not be solved, please contact my company.

Faults	Possible Solutions
Controller no response with power	Check starting batteries; Check controller connection wirings; Check DC fuse.
Genset shutdown	Check the bottom of the main interface warning; Check the genset AC voltage; Check DC fuse.
Controller emergency stop	Check emergence stop button is correct or not; Check whether the starting battery positive be connected with the emergency stop input; Check whether the circuit is open.
Low oil pressure alarm after crank disconnect	Check the oil pressure sensor and its connections.
High water temp alarm after crank disconnect	Check the temperature sensor and its connections.
Shutdown Alarm in running	Check related switch and its connections according to the information on LCD; Check programmable inputs.
Crank not disconnect	Check fuel oil circuit and its connections; Check starting batteries; Check speed sensor and its connections; Refer to engine manual.
Starter no response	Check starter connections; Check starting batteries.
Genset running while ATS not transfer	Check ATS; Check the connections between ATS and controllers.
RS485 communication is abnormal	Check connections; Check setting of COM port is correct or not; Check RS485's connections of A and B is reverse connect or not; Check whether damage RS485transfer model; Check whether damage communication port of PC.

15. Product packaging

This product should be following sets:

- (1) 1 piece of controller model **LXC61X0**.
- (2) 4 pieces of fixed cards.
- (3) 1 piece of product certificate.
- (4) 1 piece of product manual.

LXC6120/LX6110 Generator remote monitoring program

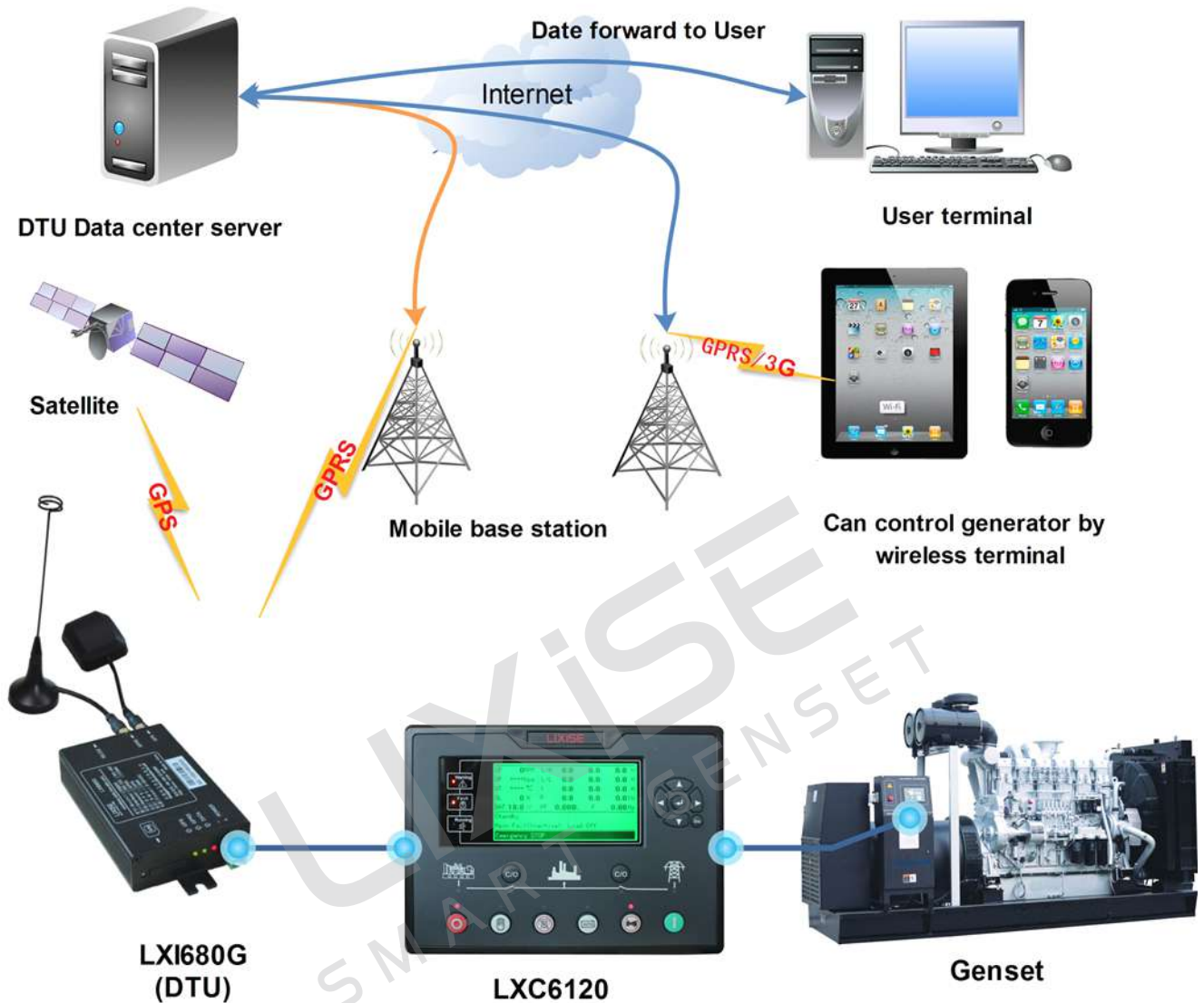

**Dongguan Tuancheng Automation
Equipment Co.,LTD.**

Tel:+86-769-23836636

Fax:+86-769-23166296

http://www.lixise.com

http://www.lixise.net

E-mail:sales@lixise.com

Add: Wentang Road, Chashang
industrial zone #18, Dongcheng,
Dongguan, Guangdong, China