

## User Manual



### ERDFS Series

1U Sun-Specific 1080p Dual Slide Drawer

Options :

- SDI
- BNC / HDMI / Audio
- DC Power

FC CE

Designed/Manufactured by Austin Hughes and Distributed by Eclipse Rackmount, Inc.

## Legal Information

First English printing, October 2002

Information in this document has been carefully checked for accuracy; however, no guarantee is given to the correctness of the contents. The information in this document is subject to change without notice. We are not liable for any injury or loss that results from the use of this equipment.

## Safety Instructions

**Please read all of these instructions carefully before you use the device. Save this manual for future reference.**

- Unplug equipment before cleaning. Don't use liquid or spray detergent; use a moist cloth.
- Keep equipment away from excessive humidity and heat. Preferably, keep it in an air-conditioned environment with temperatures not exceeding 40° Celsius (104° Fahrenheit).
- When installing, place the equipment on a sturdy, level surface to prevent it from accidentally falling and causing damage to other equipment or injury to persons nearby.
- When the equipment is in an open position, do not cover, block or in any way obstruct the gap between it and the power supply. Proper air convection is necessary to keep it from overheating.
- Arrange the equipment's power cord in such a way that others won't trip or fall over it.
- If you are using a power cord that didn't ship with the equipment, ensure that it is rated for the voltage and current labeled on the equipment's electrical ratings label. The voltage rating on the cord should be higher than the one listed on the equipment's ratings label.
- Observe all precautions and warnings attached to the equipment.
- If you don't intend on using the equipment for a long time, disconnect it from the power outlet to prevent being damaged by transient over-voltage.
- Keep all liquids away from the equipment to minimize the risk of accidental spillage. Liquid spilled on to the power supply or on other hardware may cause damage, fire or electrical shock.
- Only qualified service personnel should open the chassis. Opening it yourself could damage the equipment and invalidate its warranty.
- If any part of the equipment becomes damaged or stops functioning, have it checked by qualified service personnel.

## What the warranty does not cover

- Any product, on which the serial number has been defaced, modified or removed.
- Damage, deterioration or malfunction resulting from:
  - Accident, misuse, neglect, fire, water, lightning, or other acts of nature, unauthorized product modification, or failure to follow instructions supplied with the product.
  - Repair or attempted repair by anyone not authorized by us.
  - Any damage of the product due to shipment.
  - Removal or installation of the product.
  - Causes external to the product, such as electric power fluctuation or failure.
  - Use of supplies or parts not meeting our specifications.
  - Normal wear and tear.
  - Any other causes which does not relate to a product defect.
- Removal, installation, and set-up service charges.

## Regulatory Notices Federal Communications Commission (FCC)

This equipment has been tested and found to comply with the limits for a Class B digital device, pursuant to Part 15 of the FCC rules. These limits are designed to provide reasonable protection against harmful interference in a residential installation.

Any changes or modifications made to this equipment may void the user's authority to operate this equipment. This equipment generates, uses, and can radiate radio frequency energy and, if not installed and used in accordance with the instructions, may cause harmful interference to radio communications.

However, there is no guarantee that interference will not occur in a particular installation. If this equipment does cause harmful interference to radio or television reception, which can be determined by turning the equipment off and on, the user is encouraged to try to correct the interference by one or more of the following measures:

- Re-position or relocate the receiving antenna.
- Increase the separation between the equipment and receiver.
- Connect the equipment into an outlet on a circuit different from that to which the receiver is connected.

# Contents

## < Part. 1 > ERDFS-17

1.1	Package Contents	P.1
1.2	Structure Diagram & Dimensions	P.1 - 2
1.3	Installation	P.3 - 5
1.4	Connection	P.6 - 7

## < Part. 2 > Specifications / OSD

2.1	Product Specifications	P.8 - 9
2.2	Keyboard / Mouse Specifications	P.10 - 12
2.3	On-Screen Display Operation ( OSD )	P.13 - 14



## < Part. 3 > Options

3.1	3G / HD / SD- <b>SDI</b> Broadcast-grade input	P.15
3.2	HDMI, S-Video + BNC & Audio	P.16
3.3	48V, 24V or 12VDC power	P.17



# Contents

## < Part. 4 > Integrated KVM



### Part Numbers Ending In:

Matrix DB-15 KVM 	Local	Remote		8-port	16-port	32-port
	1	1	1	8-M3X-IP	16-M3X-IP	-
	1	1	2	8-M4X-2IP	16-M4X-2IP	-
	1	1	0	8-M2X	16-M2X	-
	1	2	0	8-M3X	16-M3X	-
	1	3	0	8-M4X	16-M4X	-



### Part Numbers Ending In:

Combo DB-15 KVM 	Local	Remote		8-port	16-port	32-port
	1	0	1	8-IP	16-IP	-
	1	1	0	8-2X	16-2X	-
1	0	0	8-USB	16-USB	-	

### Part Numbers Ending In:

DVI-D KVM 	Local	Remote		12-port	-	-
	1	0	0	12-DVI	-	-

### Part Numbers Ending In:

PS/2 DB-15 KVM 	Local	Remote		8-port	-	-
	1	0	0	8-PS2	-	-

## Before Installation

- It is very important to mount the equipment in a suitable cabinet or on a stable surface.
- Make sure the place has a good ventilation, is out of direct sunlight, away from sources of excessive dust, dirt, heat, water, moisture and vibration.

## Unpacking

The equipment comes with the standard parts shown in package content. Check and make sure they are included and in good condition. If anything is missing, or damaged, contact the supplier immediately.

## How To Clean Your LCD Monitor



### Caution :

- To avoid the risk of electric shock, make sure your hands are dry before unplugging your monitor from or plugging your monitor into an electrical outlet.
- When you clean your monitor, do not press down on the LCD screen. Pressing down on the screen can scratch or damage your display. Pressure damage is not covered under warranty.
- Use only cleansers made specifically for cleaning monitors and monitor screens. Cleansers not made to clean monitors and monitor screens can scratch the LCD display or strip off the finish.
- Do not spray any kind of liquid directly onto the screen or case of your monitor. Spraying liquids directly onto the screen or case can cause damage which is not covered under warranty.
- Do not use paper towels or abrasive pads to clean your monitor. Using an abrasive pad or any wood based paper product such as paper towels can scratch your LCD screen.

## Cleaning Your Monitor

To clean your LCD safely, please follow these steps :

- ① Disconnect the power cord.
- ② Gently wipe the surface using a clean, dry microfiber cloth. Use as little pressure as possible.

## Cleaning Tough Marks and Smudges

To remove tough marks and smudges, please follow these steps :

- ① Disconnect the power cord.
- ② Spray a small amount of non-abrasive cleanser on a microfiber cloth.



**Caution : Do not spray or apply any liquids directly onto the monitor. Always apply the solution to your microfiber cloth first, not directly on the parts you are cleaning.**

- ③ Gently wipe the surface. Use as little pressure as possible.
- ④ Wait until your monitor is completely dry before plugging it in and powering it up.

## < Part 1 >

### < 1.1 > Package Contents

ERDFS-17



#### ERDFS-17 unit X 1

- CAX-6 6ft DVI-D console cable X 1  
( Alternative : CAU-6 6ft VGA console cable )
- Power cord X 1
- M6 screw, cage nut & cup washer X 8



The above package content is only for the single console models.  
It varies with options such as KVM, SDI, HDMI, AV, Audio & DC power.

### < 1.2 > Structure Diagram

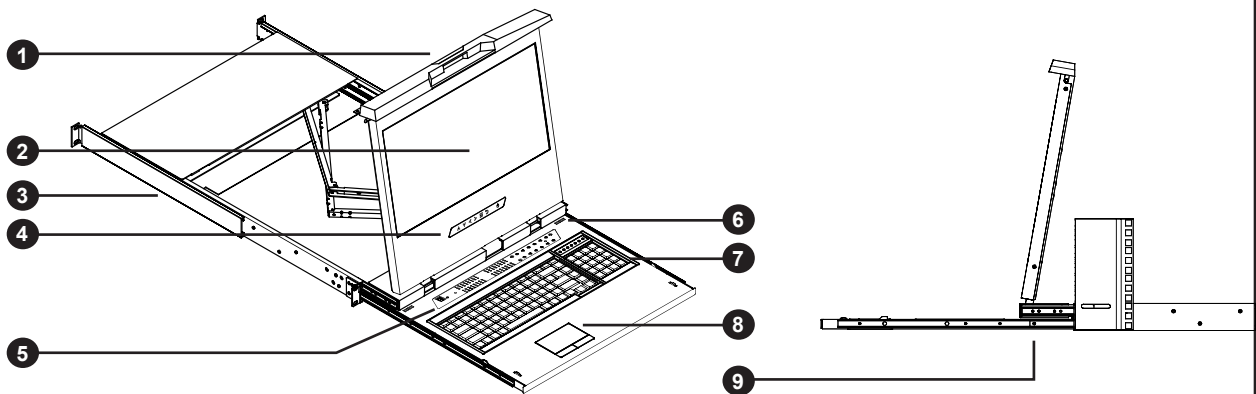

- ① Carry handle to release the 2-pt lock
- ② LCD interchangeable module kit
- ③ Installation Slides
- ④ LCD membrane 
- ⑤ Membrane switch (KVM option)

- ⑥ Audio speaker ( for HDMI or Audio option )
- ⑦ Keyboard interchangeable module kit
- ⑧ Touchpad mouse module
- ⑨ 1U dual slide for LCD console drawer

## < 1.2 > Dimensions

### Front View

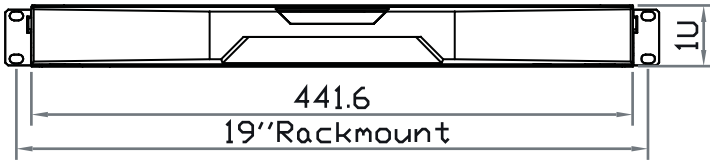

### Side View

UNIT : mm  
1mm = 0.03937 inch

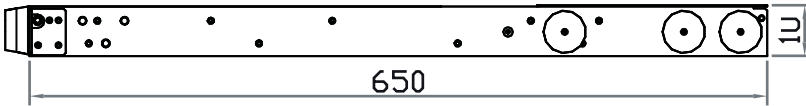

### Top View

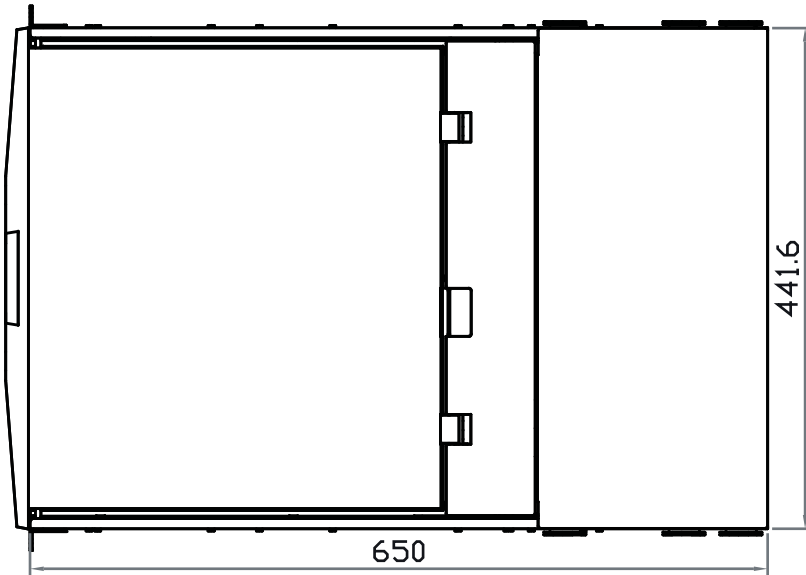

Model	Product Dimension (W x D x H)	Packing Dimension (W x D x H)	Net Weight	Gross Weight
ERDFS-17	441.6 x 650 x 44 mm 17.4 x 25.6 x 1.73"	595 x 860 x 140 mm 23.4 x 33.9 x 5.5"	11.9 kg 26.2 lb	17.9 kg 39.4 lb

**!** The weight is only for the single console models. It varies with accessories & options such as KVM, SDI, HDMI, AV, audio & DC power.

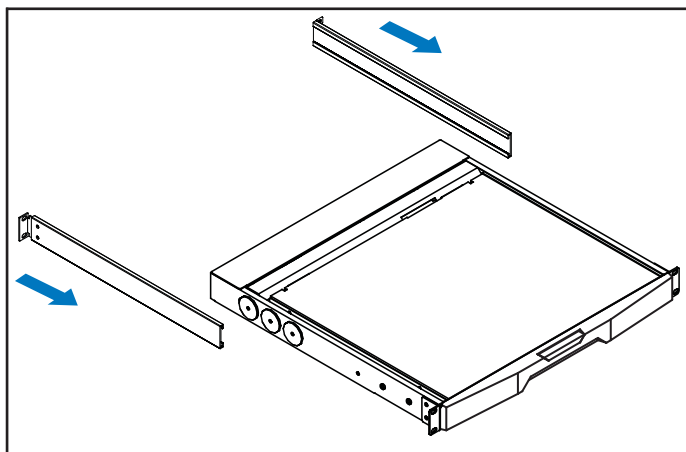

**Step 1**

- Insert the left and right rear mounting brackets into the LCD console drawer.

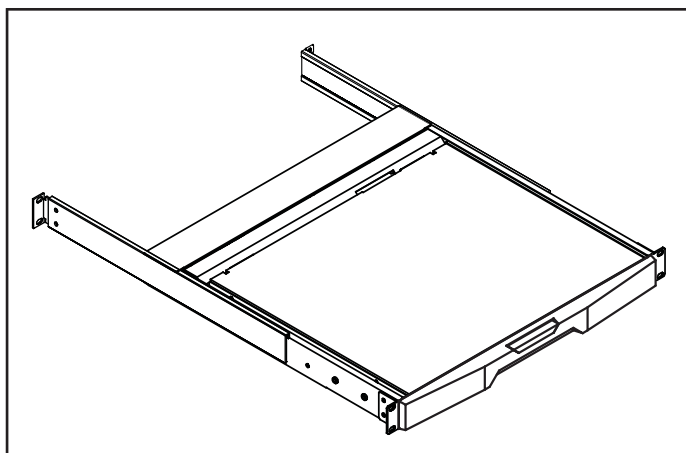

**Step 2**

- Measure the depth of the front and rear mounting rails.
- Align each rear mounting bracket to a suitable length.

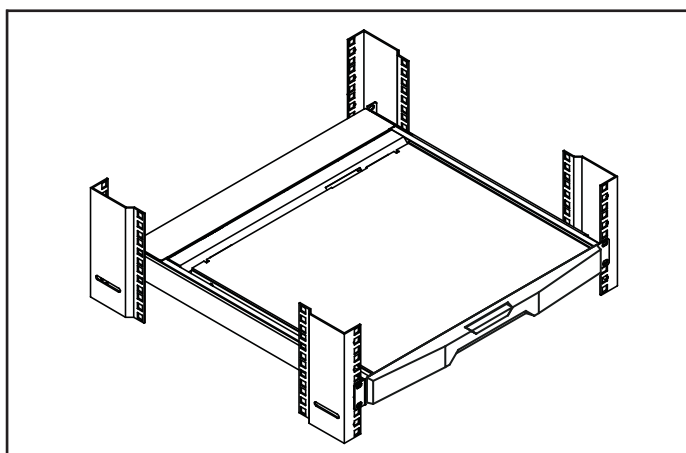

**Step 3**

**Complete the installation**

- Fix the LCD console drawer into the rack.

 **M6 screw, cage nut & cup washer x 8 are provided.**



## < 1.3 > Installation - Using the Dual Slides



- Press the handle button and gently slide out the drawer.



- Lift the LCD to a suitable angle.



- Operate the LCD console drawer.



- Flip down the front panel.



- Press the handle button and gently slide the drawer back into the rack.



- Return the LCD console drawer to park position.

## < 1.4 > Connection to **USB Server** via CAX-6 cable

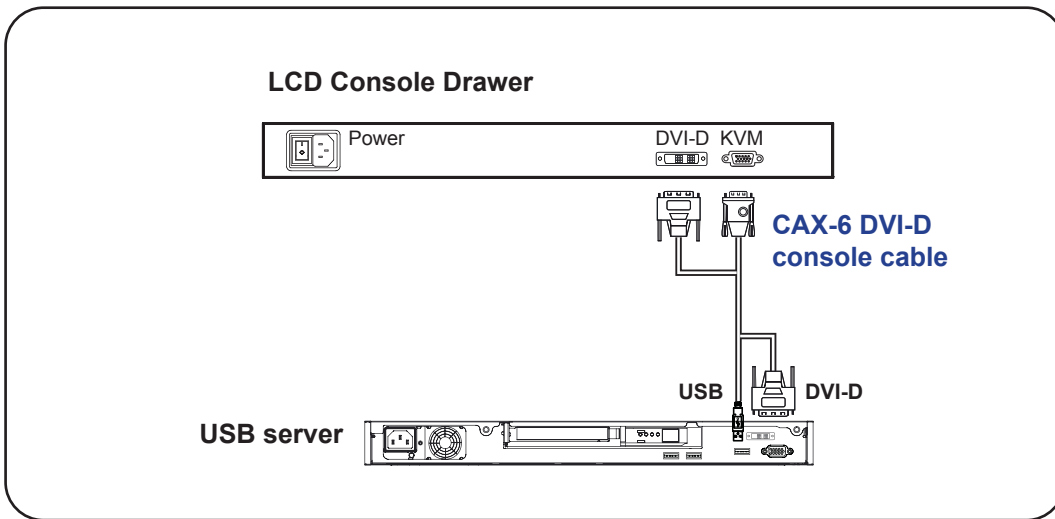

## < 1.4 > Connection to **External KVM** via CAX-6 cable

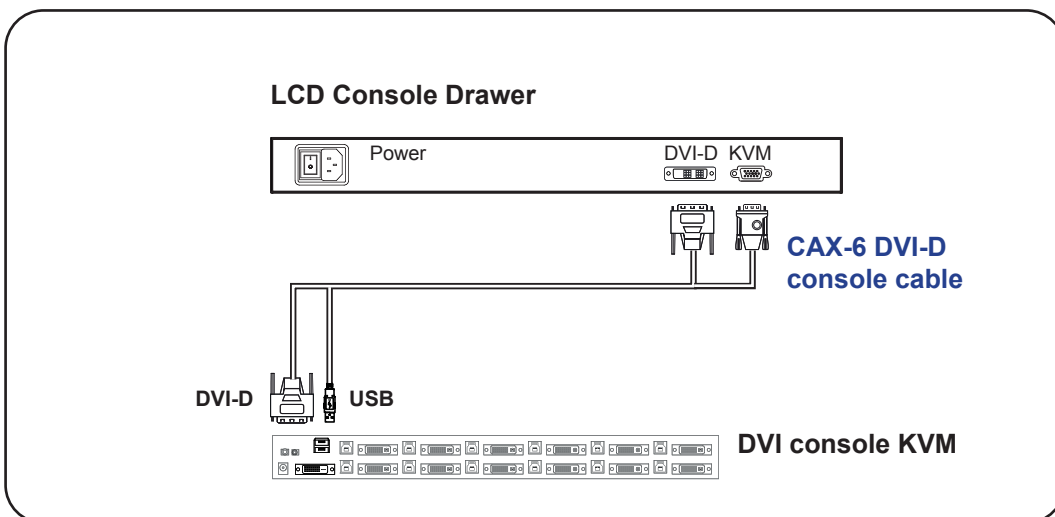

**Caution :** The LCD console drawer is hot-pluggable, but components of connected devices, such as the servers and KVM switch, may not be hot-pluggable. Plugging and unplugging cables while servers and KVM are powered on may cause irreversible damage to the servers, KVM and LCD console drawer. Before attempting to connect anything to the LCD console drawer , we suggest turning off the power to all devices. Apply power to connected devices again only after the LCD console drawer is receiving power. ERI is not responsible for damage caused in this way

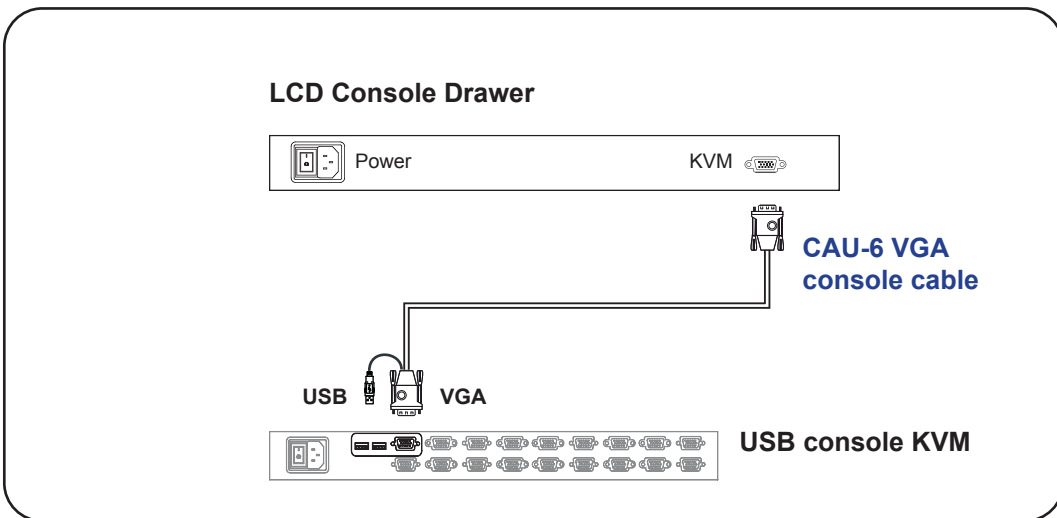
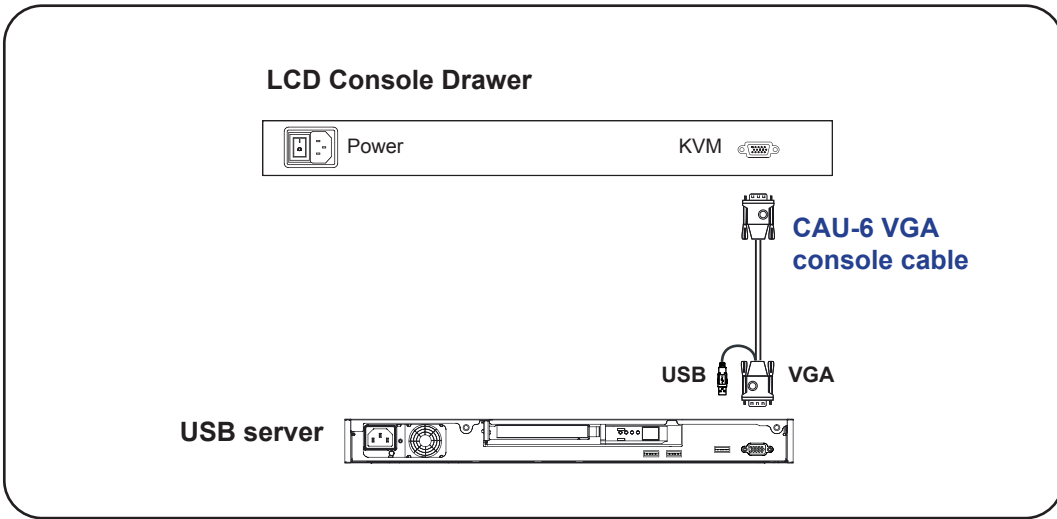

**Caution :** The LCD console drawer is hot-pluggable, but components of connected devices, such as the servers and KVM switch, may not be hot-pluggable. Plugging and unplugging cables while servers and KVM are powered on may cause irreversible damage to the servers, KVM and LCD console drawer. Before attempting to connect anything to the LCD console drawer , we suggest turning off the power to all devices. Apply power to connected devices again only after the LCD console drawer is receiving power. ERI is not responsible for damage caused in this way

## < Part 2 >

### < 2.1 > Product Specifications

<b>LCD Panel</b>	Panel Size ( diagonal )	17.3-inch Widescreen TFT color LCD
	Display pixel ( dots x lines )	1920 x 1080
	Brightness ( typ. )	300
	Contrast Ratio ( typ. )	600:1
	Color	1.07 Billion, 10-bit
	Viewing Angle ( L/R/U/D )	89/89/89/89
	Response Time ( ms )	35
	Dot pitch ( mm )	0.199
	Display Area ( mm )	381.9H x 214.8V
	Surface treatment	Anti-glare, Hard-coating
	Surface hardness	3H
	Backlight Type	LED
	MTBF ( hrs )	20,000

<b>Video Connectivity</b>	Digital	HDMI	HDMI 1.1, CEA-861-D
		DVI	DVI-D, TMDS single link
	Analog	VGA	Analog 0.7Vp-p
		Composite ( BNC )	NTSC & PAL
		S-Video ( 4-pin )	NTSC & PAL
	Plug & Play	DVI / VGA	VESA EDID structure 1.3
	Synchronization	VGA	Separate, Composite & SOG

<b>Audio Connectivity</b>	Audio Input	Connector	3.5mm stereo jack
		Impedance / Power level	30k $\Omega$ / 750mV
	Audio Output	Connector	3.5mm stereo jack
		Resistance / Power level	30k $\Omega$ / 2.8V
		Power	2 x 2W

\*When the audio output is connected, speaker output is OFF

<b>Power</b>	Power Supply	Range	Auto-sensing 100 to 240VAC, 50 / 60Hz
	Power Consumption	Screen display ON	34W or less
		Power saving mode	4W or less
		Power button OFF	1W or less

<b>Regulatory</b>	Safety Approval	FCC & CE
-------------------	-----------------	----------

<b>Environmental Conditions</b>	Operating	Temperature	0 to 50°C degree
		Humidity	20~90%, non-condensing
	Storage	Temperature	-5 to 60°C degree
		Humidity	5~90%, non-condensing
		Shock	10G acceleration (11ms duration)
		Vibration	5~500Hz 1G RMS random

<b>Physical Specification</b>	Product ( W x D x H )	441.6 x 650 x 44 mm 17.4 x 25.6 x 1.73 inch
	Packing ( W x D x H )	595 x 860 x 140 mm 23.4 x 33.9 x 5.5 inch
	Net Weight	11.9 kgs / 26.2 lbs
	Gross Weight	17.9 kgs / 39.4 lbs

<b>Applicable Format</b>	DVI-D / VGA Input	PC Signal	1920 x 1080 x 60Hz
			1360 x 768 x 60Hz
			1280 x 1024 x 60 / 75Hz
			1280 x 960 x 60Hz
			1280 x 768 x 60 / 75Hz
			1152 x 864 x 75Hz
			1024 x 768 x 60 / 70 / 75Hz
			848 x 480 x 60Hz
			800 x 600 x 60 / 72 / 75Hz
			720 x 400 x 70Hz
			640 x 480 x 60 / 72 / 75Hz
			640 x 400 x 70Hz
640 x 350 x 70Hz			

## < 2.2 > Keyboard / Mouse Specifications

**Gn** G keyboard integrated with touch pad

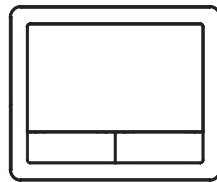
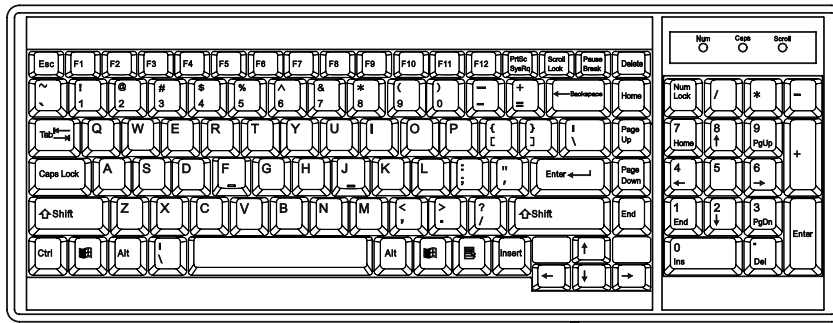

<b>Key force</b>	55 ± 5g
<b>Travelling distance</b>	3 ± 0.3mm
<b>Switch life</b>	> 10 million life cycle time
<b>Software support</b>	MS Windows 7 / 2008 / 2003 / 2000 / XP / ME / 98 / DOC Linux / Mac

### Supporting layouts

#### America



United States



United Kingdom



Germany



France



Spain



Norway

#### EMEA



Italy



Russia



Switzerland



Netherlands



Portugal

#### Asia



China



Japan



Korea



Arabia



Turkey

**Mn** MAC keyboard integrated with touch pad

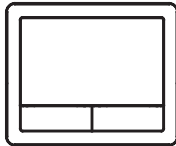
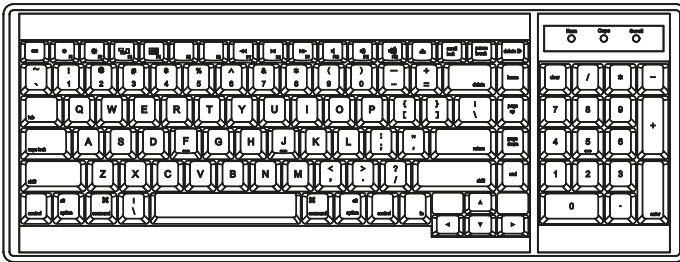

### Supporting layouts



## How to Use "MAC" Keyboard

### Keyboard Features

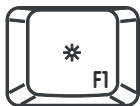

**F1**  
Decrease display brightness

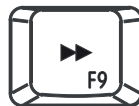

**F9**  
Fast-forward

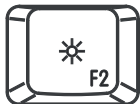

**F2**  
Increase display brightness

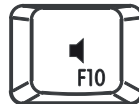

**F10**  
Mute sound



**F3**  
Mission control  
\* Only works with OS X Lion default Keyboard Shortcuts.



**F11**  
Decrease volume



**F4**  
Dashboard



**F12**  
Increase volume



**F7**  
Rewind

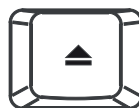

**Eject disc**



**F8**  
Play / Pause



**Command**



## < 2.2 > SUN Keyboard / Mouse Options

**Sr** S keyboard integrated with touch pad

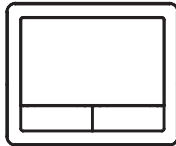
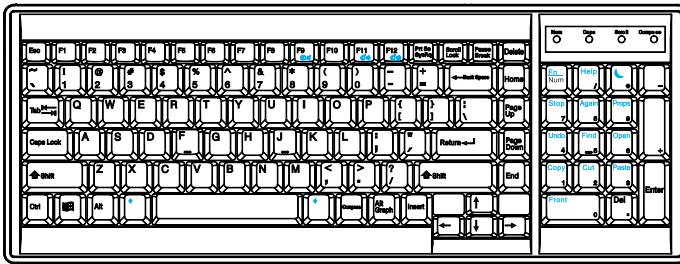

### S keyboard integrated with touch pad / track ball



- Incorporates SUN keys, including Stop, Cut, Paste, Compose, Copy and Help
- 104 key notepad keyboard with full numerical pad and SUN function
- USB interface
- US layout only

### How to Use "S" Keyboard

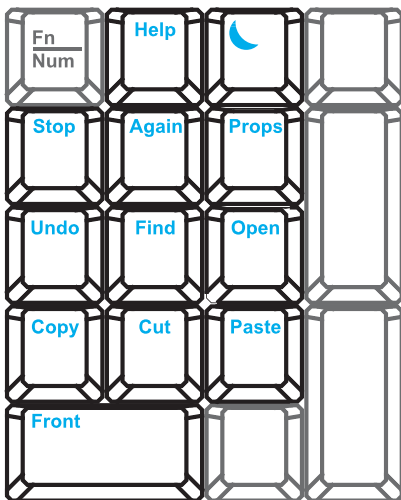

#### Num LED in Off mode

Keypad behaves as a SUN Solaris system administration command mode

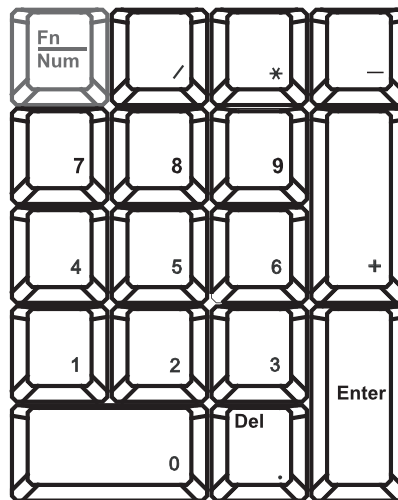

#### Num LED in Green mode

Keypad behaves as a normal keypad

### Audio / Display Keys

\* Please ask your supplier for full details

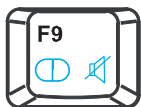

**F9**  
Audio : Mute  
Display : Degauss

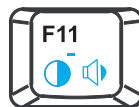



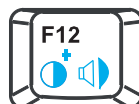

**F11**  
Audio : Decrease volume  
Display : Decrease contrast



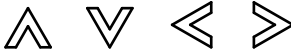

**F12**  
Audio : Increase volume  
Display : Increase contrast



Membrane Switch	Function
	Turn the monitor on or off
	Display the OSD menu Act as an Enter key to select screen setting options
	Scroll through menu options and adjust the displayed control
	Exit the OSD screen Go back to the previous on-screen sub-menu or main menu

Remark : All LED touch buttons in **WHITE** light.

The LED of **Power**  touch button will f ash continuously when there is no signal input.

- ① All the LED touch buttons will automatically turn off after 10 minutes of idle status ( except the **Power**  ).
- ② Light up all membrane buttons, please press any button for 1 - 2 seconds ( except the **Power**  ).

① **Picture**

- Picture mode : Standard / Vivid / Soft / User mode to choose
- Brightness : Adjust background black level of the screen image
- Contrast : Adjust the difference between the image background (black level) and the foreground (white level)
- Hue: Adjust the screen hue value
- Saturation : Adjust the saturation of the image color
- Picture size : Adjust the image size
- Color temp : Standard / Cool / Warm / User to choose
- Noise reduce : Reduce the noise of the image
- Sharpness : Adjust the image from weak to sharp

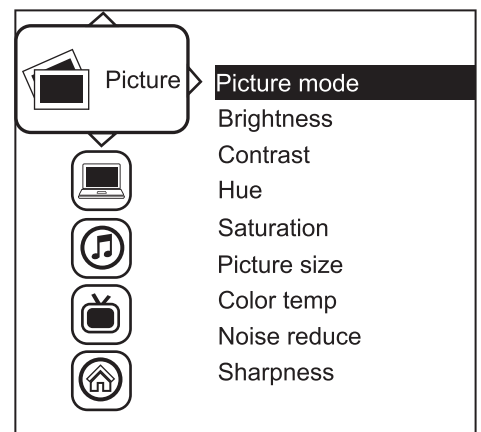

## < 2.3 > On-Screen Display Operation ( OSD )

### ② PC

Auto adjust :	Automatically adjust sizes, centers and fine tunes the video signal to eliminate waviness and distortion.
Clock :	Adjust the clock value
Phase :	Adjust the phase value
H. Position :	Align the screen image left or right
V. Position :	Align the screen image up or down

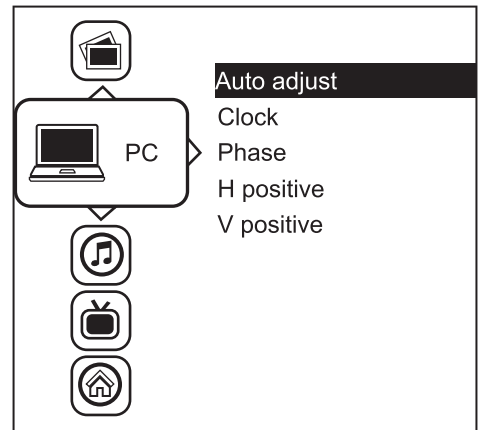

### ③ Audio

Audio mode :	Movie / Voice / Normal / Music mode to choose
Volume :	Adjust the volume of sound
Bass :	Set the value of bass sound
Treble :	Set the value of treble sound
Balance :	Set the balance value of treble and bass sound
Analog TV audio :	Set the value of analog TV audio sound
Mute :	Turn off the surrounding sound

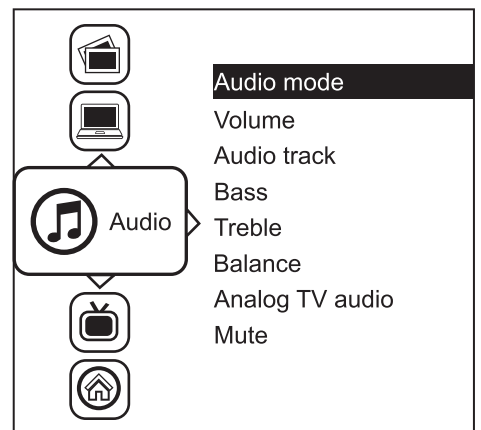

### ④ MISC

Language :	Select the language in which the OSD menu is displayed - English
Sleep timer :	Set the off time
PIP mode :	Adjust picture in picture setting
PIP position :	Enter into PIP position
PIP source :	Enter into the Sub source and sound source
System reset :	Return the adjustment back to factory setting
Information :	Select for Help

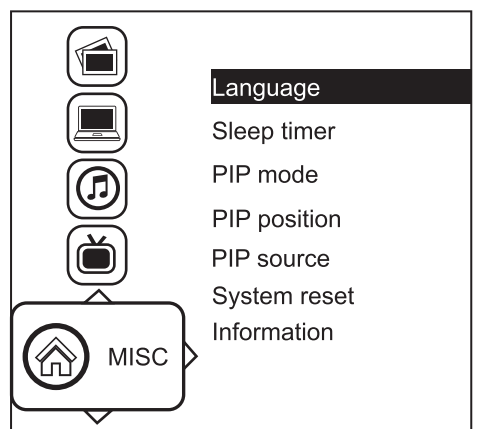

< Part 3 >

< 3.1 > Options : 3G / HD / SD-SDI input

ERDFS-17



The SDI input is an ideal solution for the broadcast-grade video and high resolution CCTV market.

Designed for use with CyberV iew Full HD 1080p and ultra high resolution 1920 x 1200 LCD displays, the board provides an SDI input module without using additional space or power and it comes standard with a 2-year warranty.

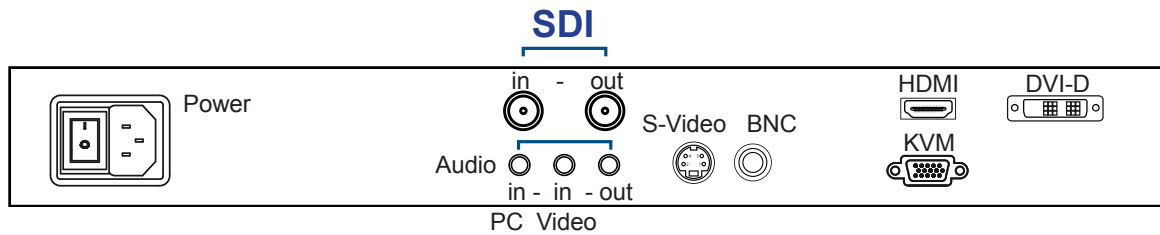

<b>INPUT</b>	3G-SDI IN	BNC x 1 / 0.8Vp-p ( 75 ohm )
	3G-SDI OUT	BNC x 1 / Active through, equalized & relocked

<b>Standard Compliance</b>	Video	SMPTE 425M / 274M / 296M / 125M ITU-R BT.656
	Audio	SMPTE 299M / 272M-C

<b>Compatible Video Format</b>	3G-SDI	1080p @60 / 50Hz, 4:2:2
		1080p @30 / 25 / 24Hz, 4:4:4
		1080i @60 / 50Hz, 4:4:4
		720p @60 / 50Hz, 4:4:4
	HD-SDI	1080p @30 / 25 / 24Hz, 4:2:2
		1080i @60 / 50Hz, 4:2:2
		720p @60 / 50Hz, 4:2:2
SD-SDI	480i @60Hz, 4:2:2	
ITU-R BT.656	576i @50Hz, 4:2:2	

<b>Compatible Audio Format</b>	3G-SDI	48kHz, 16 / 20 / 24 bit, 2 CH, Synchronized Video
	HD-SDI	48kHz, 16 / 20 / 24 bit, 2 CH, Synchronized Video
	SD-SDI	48kHz, 16 / 20 / 24 bit, 2 CH, Synchronized / Asynchronized Video

<b>Max. Transmission Distance 75 ohm coaxial cable</b>	3G-SDI	150m at 2.97Gb/s
	HD-SDI	250m at 1.485Gb/s
	SD-SDI	480m at 270Mb/s

### < 3.2 > Options :

- **HDMI** ( HDMI 1.1, CEA-861-D )
- **BNC** ( S-Video + Composite, BNC )
- **Audio** ( 3.5mm audio jacks for audio in & out, and 2W + 2W speakers )



For dual slide 1U / 2U LCD console drawer, the user can only select one of the above four options.

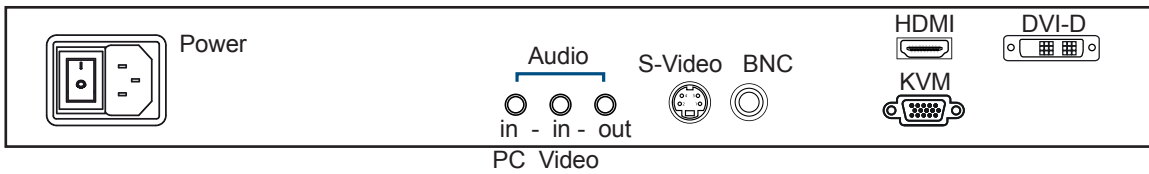

### < 3.3 > Options : DC Power

Model	12V	24V	48V
<b>Input rating</b>			
Input voltage:	12-Volt	24-Volt	48-Volt
Input range:	9 ~ 18V	18 ~ 36V	36 ~ 75V
Input current			
- No load	50 mA	50 mA	50 mA
- Full load	4950 mA	2450 mA	1220 mA
<b>Output rating</b>			
Output voltage:	12-Volt	12-Volt	12-Volt
Output current:	4.16A	4.16A	4.16A
<b>Efficiency</b>	84%	85%	85%

### DC power

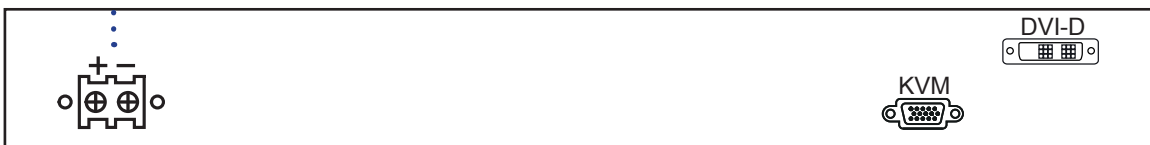

\*\*\*

Option excludes 1 x power cord and 1 x AC power adapter

The company reserves the right to modify product specifications without prior notice and assumes no responsibility for any error which may appear in this publication.

All brand names, logo and registered trademarks are properties of their respective owners.

Copyright 2013 Austin Hughes Electronics Ltd. & Eclipse Rackmount, Inc. All rights reserved.