

User's Manual

CNPS 5X

Intel Socket 1155 / 1156 / 775 CPU

- Core i7
- Core i5
- Core i3
- Core 2 Extreme
- Core 2 Quad
- Core 2 Duo
- Dual Core Pentium
- Pentium D
- Pentium 4
- Celeron D

AMD Socket AM3 / AM2+ / AM2 CPU

- Phenom II
- Phenom
- Athlon II
- Athlon X2
- Athlon FX
- Athlon
- Opteron
- Dual-Core Opteron
- Sempron

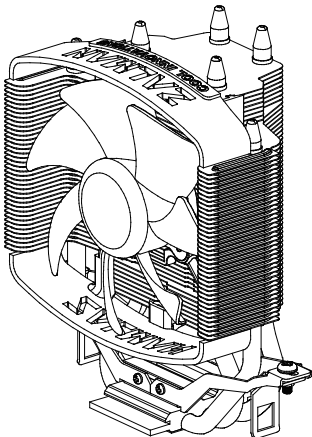

To ensure safe and easy installation,
please read the following precautions

www.ZALMAN.com

1. Precautions

- 1) Avoid inserting objects or hands into the fan while it is in operation to prevent product damage and injuries.
- 2) Do not ingest the Thermal Grease, and avoid its contact with skin and eyes. If contact is made with skin, wash off with water. If ingested or irritation persists, seek medical attention.
- 3) To prevent possible injuries, gloves must be worn while handling this product.
- 4) Excessive force exerted on the fan may cause damage to the fan and/or system.
- 5) Use and keep product away from reach of children.
- 6) Check the components list and condition of the product before installation. If any problem is found, contact the retailer to obtain a replacement.
- 7) During transportation of the system, the cooler must be removed. Zalman is not responsible for any damages that occur during the transport of a system.
- 8) Product design and specifications may be revised to improve quality and performance.
- 10) Enable PWM function in BIOS settings after installation.

Disclaimer) Zalman Tech Co., Ltd. is not responsible for any damages due to external causes, including but not limited to, improper use, problems with electrical power, accident, neglect, alteration, repair, improper installation, or improper testing.

2. Specifications

Spec.		Model	CNPS 5X
Material			Pure Copper and Aluminum
Weight			320g
Dimensions			127(L) X 64(W) X 134(H)mm
Fan	Bearing-Type		Enter Bearing
	RPM		1,400 ~ 2,800rpm \pm 10%
	Noise Level		20 ~ 32dBA \pm 15%
	Input Voltage		12V
	Function		PWM Control, Auto Restart

3. Components

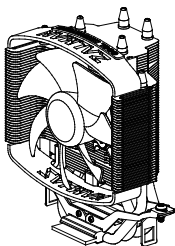

Cooler

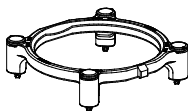

Backplate



User's Manual

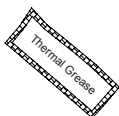

Thermal Grease

4. Installation Requirements

1) Space Requirements

The cooler's installation requires an unobstructed space of 130mm (width), 65mm (length), and 135mm (height), with the CPU as a central reference point. Please check if components such as ODDs and PSU protrude into the required space.

2) Air Guide Removal

Air guides on enclosures must be removed before the cooler's installation since they protrude into the cooler's required space.

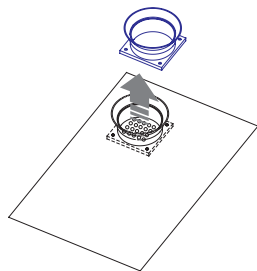
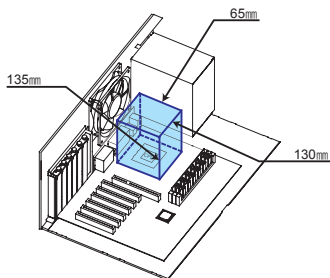

3) Cooler Orientation

As shown in the diagram below, it is recommended that the cooler be installed so that air flows from the cooler toward the enclosure's rear exhaust fan to be released.

※ Recommended cooler orientation may differ according to the motherboard model.

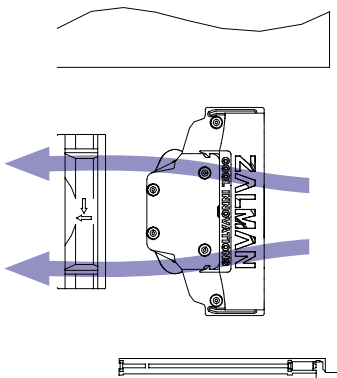

5. Installation

1) Intel Socket 1155 / 1156 / 775 Installation

① Install the Clip Support to the motherboard according to the socket-type. (See diagram)

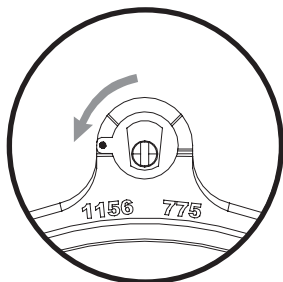

Socket 1155 / 1156

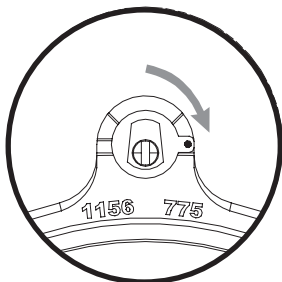

Socket 775

- ② Align the Clip Support to the motherboard and fasten with the Pushpins.

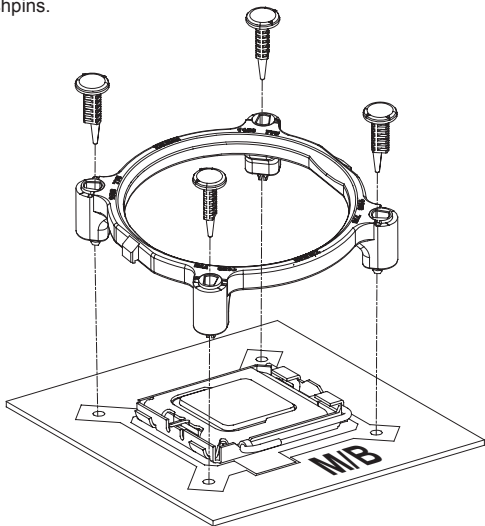

- ③ Clear off any particles or residue from the CPU's surface. Then spread a thorough layer of Thermal Grease on the CPU and the base of the cooler.

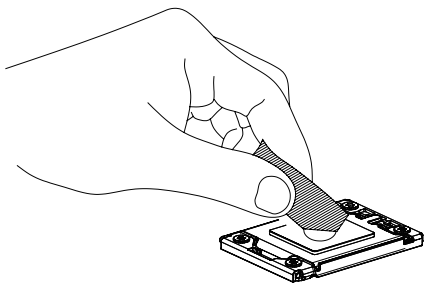

- ④ Completely unfasten the 2 bolts already assembled on the clip and adjust the position to fit the Intel socket. When reassembling the bolt, be sure to assemble only half way of the total length.

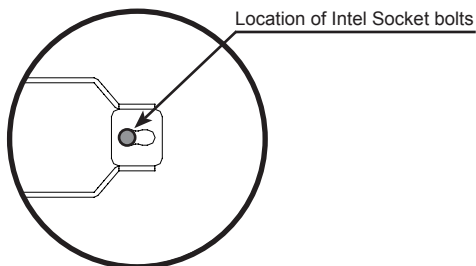

- ⑤ Install the cooler on the Clip support as shown in the picture and connect the lug slot of the clip on to the lug on the clip support. Then fasten the bolts on each side a few turns at a time.

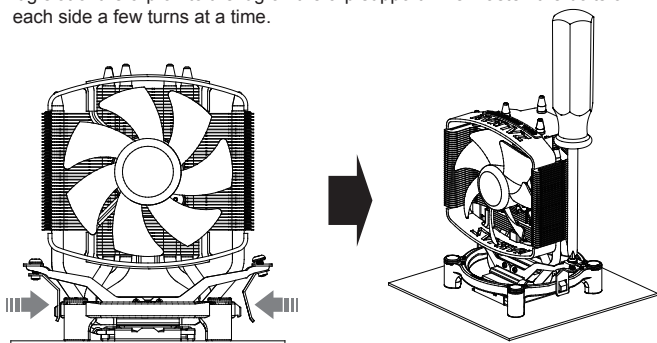

- ⑥ Connect the cooler's 4-pin connector to the motherboard's CPU Fan header.

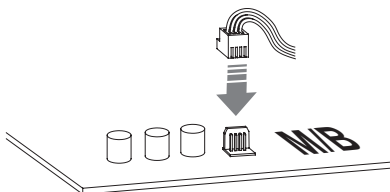

Caution

The PWM fan's operation will vary depending on the motherboard's BIOS settings.

2) AMD Socket AM3 / AM2+ / AM2 Installation

- ① Clear off any particles or residue from the CPU's surface. Then spread a thorough layer of Thermal Grease on the CPU and the base of the cooler.

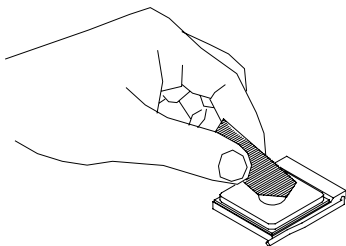

- ② Completely unfasten the 2 bolts already assembled on the clip and adjust the position to fit the AMD socket. When reassembling the bolt, be sure to assemble only half way of the total length.

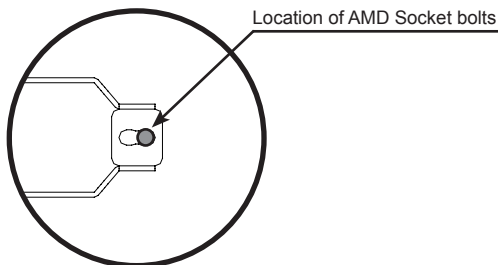

- ③ Install the cooler on the Clip support as shown in the picture and connect the lug slot of the clip on to the lug on the clip support. Then fasten the bolts on each side a few turns at a time.

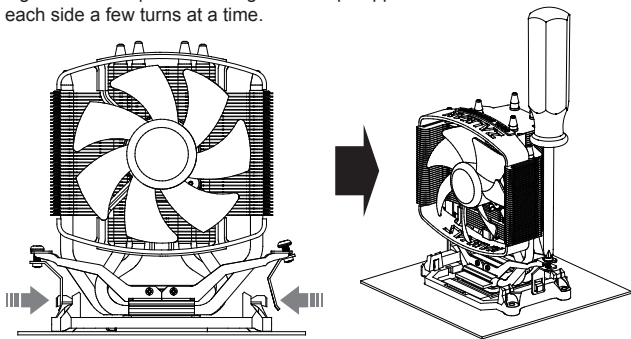

- ④ Connect the cooler's 4-pin connector to the motherboard's CPU Fan header.

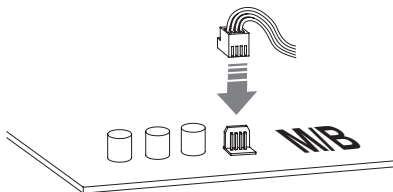
**Caution**

The PWM fan's operation will vary depending on the motherboard's BIOS settings.