

S8 AutoSet Spirit™ System

Component of 338193/1

ILLUSTRATIONS

A SYSTEM COMPONENTS

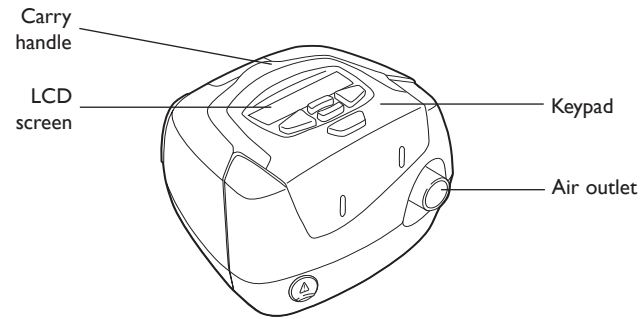

1

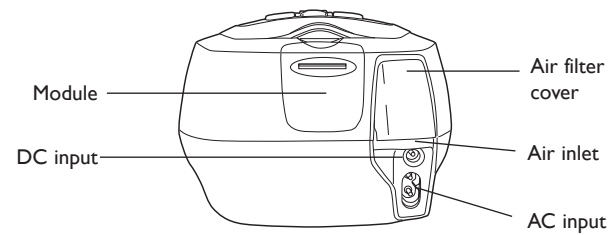

2

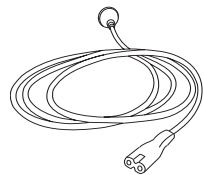

3



4

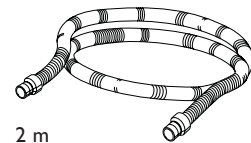

2 m
5

© 2005 ResMed Ltd.

Note: Some products not available in all regions

B INTEGRATED HUMIDIFIER

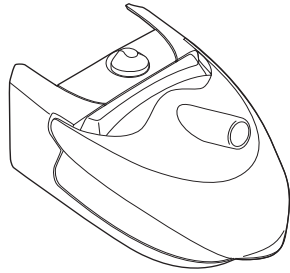

HumidAire 3i™

© 2005 ResMed Ltd.

C OTHER ACCESSORIES



1

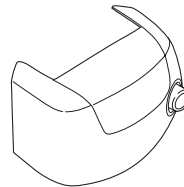

2

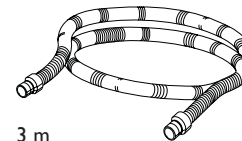

3 m
3

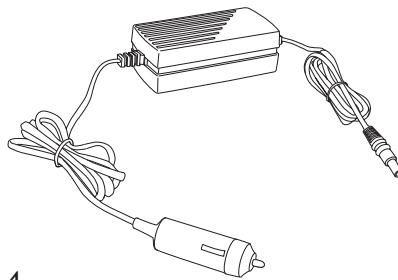

4

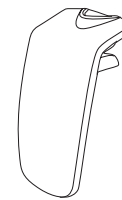

5

© 2005 ResMed Ltd.

D SETTING UP THE S8™

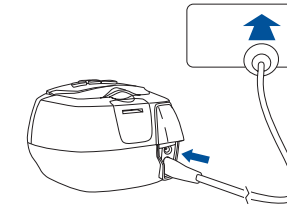

1

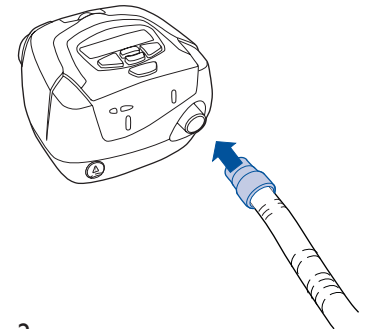

2

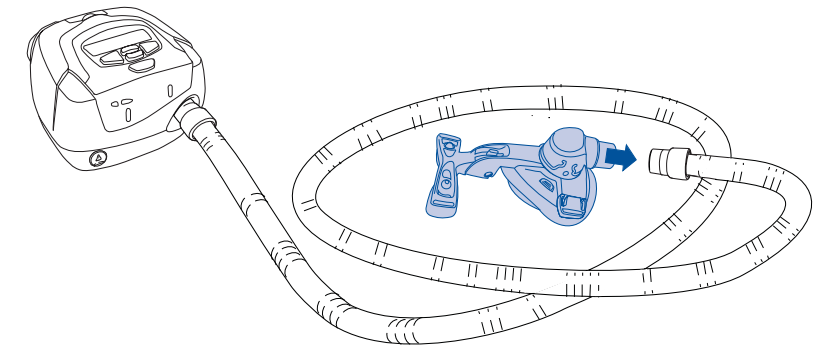

3

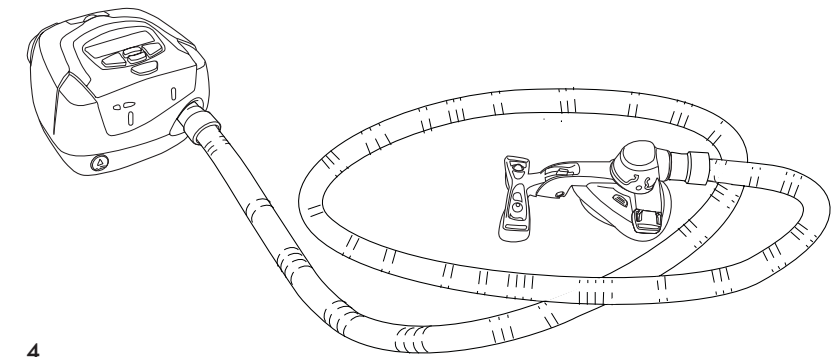

4

© 2005 ResMed Ltd.

E HUMIDAIRE 3i AND S8

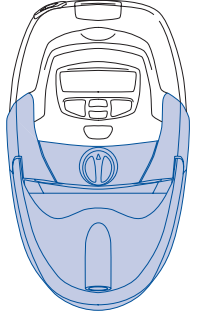

HumidAire 3i

© 2005 ResMed Ltd.

H USING THE DATA CARD

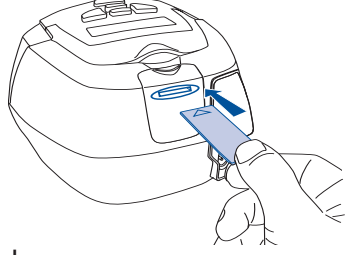

1

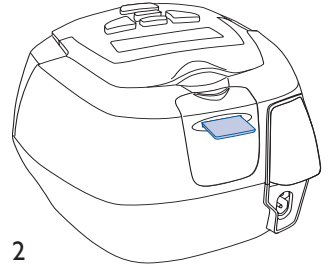

2

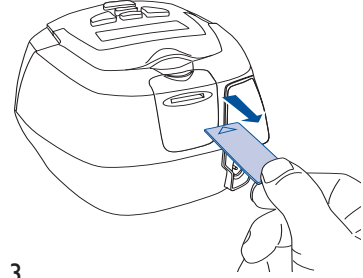

3

© 2005 ResMed Ltd.

F BLANK MODULE

Data communications port

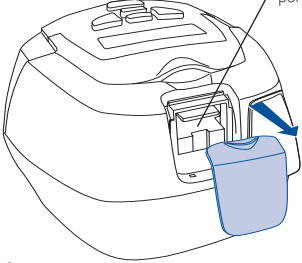

1

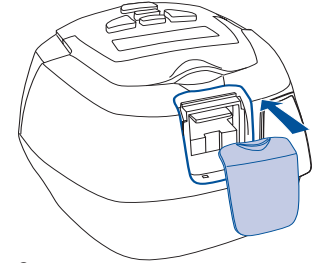

2

© 2005 ResMed Ltd.

G DATA CARD MODULE

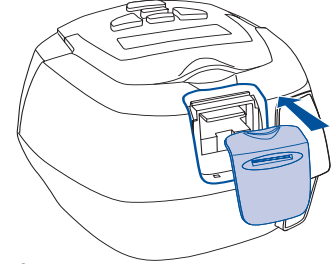

1

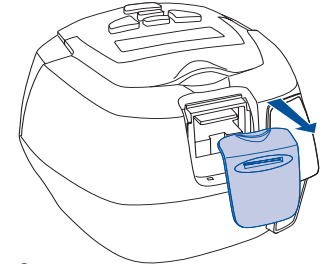

2

© 2005 ResMed Ltd.

Note: Some products not available in all regions

RESMED

S8 AutoSet Spirit™ System

Reorder number: 338193/1 05 05

USER'S MANUAL

English

Manufactured by:

ResMed Ltd 1 Elizabeth Macarthur Drive Bella Vista NSW 2153 Australia
Tel: +61 (2) 8884 1000 or 1 800 658 189 (toll free) Fax: +61 (2) 8883 3114 Email: reception@resmed.com.au

Distributed by:

ResMed Corp 14040 Danielson Street Poway CA 92064-6857 USA
Tel: +1 (858) 746-2400 or 1-800-424-0737 (toll free) Fax: +1 (858) 746-2900 Email: reception@resmed.com

ResMed (UK) Limited 65 Milton Park Abingdon Oxfordshire OX14 4RX UK
Tel: +44 (1235) 862 997 Fax: +44 (1235) 831 336 Email: reception@resmed.co.uk

ResMed Asia Pacific Ltd 97 Waterloo Road North Ryde NSW 2113 Australia
Tel: +61 (2) 9886 5000 or 1 800 991 900 (toll free) Fax: +61 (2) 9889 1471 Email: reception@resmed.com.au

ResMed BV Nieuwe Parklaan 86, 2587 BV Den Haag Nederland
Tél: +31 (70) 358 6263 Fax: +31 (70) 358 4333 Email: receptiondh@resmed.nl

ResMed Finland Niittykatu 6 FIN 02200 Espoo Suomi
Puh: +358 9 8676820 Faksi: +358 9 86768222 Sähköposti: reception@resmed.fi

ResMed GmbH & Co. KG Fraunhoferstraße 16 82152 Martinsried Deutschland
Tel: +49 (0) 89 / 99 01 - 00 and +49 (0) 800 2 777 000 (gebührenfrei) Fax: +49 (0) 89 / 99 01 - 10 55
Email: reception@resmed.de

ResMed Hong Kong Limited Room 1714, Miramar Tower 132-134 Nathan Road Tsim Sha Tsui Hong Kong
Tel: +852 2366 0707 Fax: +852 2366 4546 Email: reception@resmed.com.hk

ResMed Japan Nihonbashi Hisamatsu Bldg. 4F, 2-28-1 Nihonbashi-Hamacho, Chuo-Ku, Tokyo 103-0007, Japan
Tel: +81 (3) 3662 5056 Fax: +81 (3) 3662 5040

ResMed Malaysia Sdn Bhd Suite E-10-20, Plaza Mon't Kiara No. 2 Jalan 1/70C Mon't Kiara 50480 Kuala Lumpur
Malaysia Tel: +60 3 6201 7177 Fax: +60 3 6201 2177 Email: reception@resmed.com.my

ResMed NZ Ltd PO Box 51-048 Pakuranga Auckland New Zealand
Tel: +64 274 737 633 Fax: +64 9 239 0193 Email: reception@resmed.co.nz

ResMed SA Parc de la Bandonnière 2, rue Maurice Audibert 69800 Saint-Priest France
Tél: +33 (0) 4 37 251 251 Fax: +33 (0) 4 37 251 260 Email: reception@resmed.fr

ResMed Singapore Pte Ltd 238A Thomson Road # 12-03/04 Novena Square Tower A Singapore 307684
Tel: +65 6284 7177 Fax: +65 6284 7787 Email: reception@resmed.com.sg

ResMed Spain SL C/Arturo Soria, 245 28033 Madrid España
Tel: +34 (93) 5908154 Fax: +34 (93) 5908153 Email: angelo@resmed.es

ResMed Sweden AB Industrigatan 2 S-461 37 Trollhättan Sverige
Tel: +46 520 420 110 Fax: +46 520 397 15 Email: reception@resmed.se

Labhardt AG Thannerstrasse 57 CH-4054 Basel Schweiz
Tel: +41 (061) 307 9711 Fax: +41 (061) 307 9722 Email: info@labhardt.ch

US DESIGNATED AGENT: ResMed Corp

EU AUTHORISED REPRESENTATIVE: ResMed (UK) Ltd

www.resmed.com

Protected by patents: AU 691200, AU 697652, AU 709279, AU 724589, AU 730844, AU 736723, AU 750095, AU 750761, AU 764761, EP 0651971, EP 0661071, EP 0920845, EP 0934723, EP 1028769, JP 3580776, NZ 504595, US 4944310, US 5199424, US 5245995, US 5522382, US 5704345, US 6029665, US 6138675, US 6240921, US 6363933, US 6367474, US 6398739, US 6425395, US 6502572, US 6591834, US 6635021, US 6705315, US 6745768, US 6817361. Other patents pending. Design registrations pending.

S8, HumidAire, HumidAire 3i, AutoSet, S8 AutoSet Spirit, Mirage Activa, Mirage Vista, Ultra Mirage, Mirage Swift and ResScan are trademarks of ResMed Ltd. Papillon is a trademark of MAP Medizin-Technologie GmbH.

© ResMed Ltd 2005.



CONTENTS

INTRODUCTION	1
YOUR RESPONSIBILITY	1
MEDICAL INFORMATION	1
ABOUT THE S8 AUTOSET SPIRIT	1
CONTRAINDICATIONS	1
WARNINGS	2
CAUTIONS	3
ADVERSE EFFECTS	3
THE S8 AUTOSET SPIRIT SYSTEM	5
S8 AUTOSET SPIRIT	5
MASKS	5
HUMIDIFIER	6
RESSCAN DATA CARD MODULE	6
ACCESSORIES	6
HOW TO USE THE S8 AUTOSET SPIRIT	7
SET UP THE S8 AUTOSET SPIRIT	7
ASSEMBLE THE MASK	7
START TREATMENT	8
STOPPING TREATMENT	9
USING THE MASK-FITTING FEATURE	9
HOW TO ATTACH A HUMIDIFIER	11
ATTACH A HUMIDAIRE 3i HUMIDIFIER	11
HOW TO USE THE KEYPAD	13
HOW TO CHANGE THE SETTINGS	14
HOW TO USE THE STANDARD MENU	17
HOW TO USE THE DETAILED MENU	19
SETTINGS MENU	19
RESULTS MENU	21
OPTIONS MENU	21
SERVICING MENU	21
MESSAGES ON THE S8 AUTOSET SPIRIT LCD	21
S8 MODULES	23
USING A BLANK MODULE	23
USING A RESSCAN DATA CARD MODULE	23

CLEANING AND MAINTENANCE	27
DAILY CLEANING	27
WEEKLY CLEANING	27
PERIODIC CLEANING	27
REPLACING THE AIR FILTER	28
SERVICING	28
FREQUENTLY ASKED QUESTIONS	29
TROUBLESHOOTING	31
SYSTEM SPECIFICATIONS	35
S8 AUTOSET SPIRIT (NO ACCESSORIES)	35
ACCESSORIES	35
ALL DEVICES (WHERE APPLICABLE)	36
LIMITED WARRANTY	41
INDEX	43

INTRODUCTION

Thank you for choosing the S8 AUTOSET SPIRIT™ flow generator. The S8 AUTOSET SPIRIT is a compact, all-in-one package with an inbuilt power supply and the option of integrated data management and humidification.

This user manual contains the information you need for the correct use of your S8 AUTOSET SPIRIT.

YOUR RESPONSIBILITY

The owner or user of this system shall have sole responsibility and liability for any injury to persons or damage to property resulting from:

- operation which is not in accordance with the operating instructions supplied
- maintenance or modifications carried out unless in accordance with authorised instructions and by authorised persons.

Please read this manual carefully before use.

This manual contains special terms and icons that appear in the margins to draw your attention to specific and important information.

- Warning alerts you to possible injury.
- Caution explains special measures for the safe and effective use of the device.
- Note is an informative or helpful note.

MEDICAL INFORMATION

ABOUT THE S8 AUTOSET SPIRIT

The S8 AUTOSET SPIRIT self-adjusting sleep apnoea system is indicated for the treatment of obstructive sleep apnoea (OSA) in adult patients. The S8 AUTOSET SPIRIT self-adjusting sleep apnoea system has two treatment modes: AutoSet and fixed-pressure CPAP.

The S8 AUTOSET SPIRIT system is intended for home and hospital use.

CONTRAINDICATIONS

The S8 AUTOSET SPIRIT is not a life support device and may stop operating during power failure or certain fault conditions. It should not be used by patients who are dependent on continuous therapy.

Positive airway pressure therapy may be contraindicated in some patients with the following pre-existing conditions:

- severe bullous lung disease
- pneumothorax
- pathologically low blood pressure
- dehydration

- cerebrospinal fluid leak, recent cranial surgery, or trauma.

WARNINGS

- The entire manual should be read before using the **S8 AUTOSET SPIRIT**.
- Advice contained in this manual should not supersede instructions given by the prescribing physician.
- A patient should not connect a device to the data communication port unless instructed to do so by their health care provider or physician. Only ResMed products are designed to be connected to the data communication port. Connecting other devices could result in injury, or damage to the **S8 AUTOSET SPIRIT** device.
- The **S8 AUTOSET SPIRIT** should only be used with masks (and connectors)* recommended by ResMed, or by a physician or respiratory therapist. A mask should not be used unless the **S8 AUTOSET SPIRIT** device is turned on and operating properly. The vent hole or holes associated with the mask should never be blocked.

Explanation: The **S8 AUTOSET SPIRIT** is intended to be used with special masks (or connectors)* which have vent holes to allow continuous flow of air out of the mask.

When the device is turned on and functioning properly, new air from the device flushes the exhaled air out through the mask vent holes. However, when the device is not operating, insufficient fresh air will be provided through the mask, and the exhaled air may be rebreathed. Rebreathing of exhaled air for longer than several minutes can, in some circumstances, lead to suffocation. This applies to most models of CPAP devices.

- In the event of power failure or machine malfunction, remove the mask.
- The **S8 AUTOSET SPIRIT** can be set to deliver pressures up to 20 cmH₂O. In the unlikely event of certain fault conditions, pressures up to 30 cmH₂O are possible.
- If oxygen is used with this device, the oxygen flow must be turned off when the device is not operating.

Explanation: When the CPAP device is not in operation and the oxygen flow is left on, oxygen delivered into the air delivery tubing may accumulate within the CPAP machine enclosure and create a risk of fire. This applies to most types of CPAP machines.

- Oxygen supports combustion. Oxygen should not be used while you are smoking or in the presence of an open flame.
- Always ensure airflow is being generated by the device before the oxygen supply is turned on.
- Always turn the oxygen supply off before stopping the airflow from the device.

Note: *At a fixed rate of supplemental oxygen flow, the inhaled oxygen concentration*

* Ports may be incorporated into the mask or in connectors that are near the mask.

will vary, depending on where the oxygen is introduced, the pressure settings, patient breathing pattern, mask selection, and leak rate.

- Do not use the **S8 AUTOSET SPIRIT** if there are obvious external defects or unexplained changes in performance.
- Do not open the **S8 AUTOSET SPIRIT** case. There are no user serviceable parts inside. Repairs and internal servicing should only be performed by an authorised service agent.
- Explosion hazard—do not use in the vicinity of flammable anaesthetics.

CAUTIONS

- At low pressures, the flow through the exhalation ports of your mask may not clear all exhaled gas from the tubing. Some rebreathing may occur.
- The air flow for breathing produced by this device can be as much as 11°F (6°C) higher than the temperature of the room. Caution should be exercised if the room temperature is warmer than 90°F (32°C).
- When AC mains power (100/240 V AC) is not available, always use a ResMed DC-12 converter. (The DC-12 converter is available as an optional accessory.)
- If supplied, the **RESSCAN™** Data Card module is designed for use with specific ResMed devices.
- Only use the **RESSCAN** Data Card module (if supplied) as specified in this manual.

Note: *The above are general warnings and cautions. Specific warnings, cautions, and notes appear with the relevant instructions in the manual.*

ADVERSE EFFECTS

Patients should report unusual chest pain, severe headache or increased breathlessness to their prescribing physician. An acute upper respiratory tract infection may require temporary discontinuation of treatment.

The following side effects may arise during the course of therapy with the S8 device:

- drying of the nose, mouth or throat
- nosebleed
- bloating
- ear or sinus discomfort
- eye irritation
- skin rashes
- chest discomfort.

THE S8 AUTOSET SPIRIT SYSTEM

The S8 AUTOSET SPIRIT device is part of a system that consists of five elements:

- S8 AUTOSET SPIRIT self-adjusting flow generator
- Mask
- Humidifier
- Data management products
- Accessories.

S8 AUTOSET SPIRIT

Please refer to the illustrations in section **A** of the illustration sheet.

FRONT VIEW (A-1)

Shows the keypad and LCD screen, and the air outlet.

REAR VIEW (A-2)

Shows where the module attaches, and the location of the air filter and power sockets.

POWER CORD (A-3)

Power cord to attach the S8 AUTOSET SPIRIT to the AC (mains) power.

CARRY BAG (A-4)

The S8 AUTOSET SPIRIT carry bag contains two pouches: one for storing the S8 device, the other for storing the integrated humidifier. When storing the humidifier, always put it in the larger, mesh pouch.

AIR TUBING (A-5)

The 2 m air tubing connects the S8 AUTOSET SPIRIT to your mask.

MASKS

You will also need a **ResMed mask system** (supplied separately).

The ResMed mask systems that are recommended for use with the S8 AUTOSET SPIRIT are:

NASAL MASKS

- MODULAR NASAL MASK
- MIRAGE VISTA™ NASAL MASK
- ULTRA MIRAGE™ NASAL MASK
- MIRAGE™ NASAL MASK
- MIRAGE ACTIVA™ NASAL MASK
- PAPILLON™.

NASAL PILLOWS SYSTEMS

- MIRAGE SWIFT™ NASAL PILLOWS SYSTEM

FULL FACE MASKS

- MIRAGE™ FULL FACE MASK
- MIRAGE™ FULL FACE MASK SERIES 2

- ULTRA MIRAGE™ FULL FACE MASK.

Note: Not all masks are available in all regions.



WARNING

In AutoSet mode, only ResMed mask systems are compatible for use with the S8 AutoSet Spirit. Please refer to “Warnings” on page 2.

HUMIDIFIER

Please refer to the illustration in section **B** of the illustration sheet.

A humidifier may be required if you are experiencing dryness of the nose, throat, or mouth. The S8 AUTOSET SPIRIT is compatible for use with the HUMIDAIRE 3i™ integrated heated humidifier.

RESCAN DATA CARD MODULE

The RESCAN Data Card module and RESCAN Data Card (**C-1**) may be used with the S8 AUTOSET SPIRIT either to help your clinician to monitor your treatment or to provide you with updates to your device settings. See “Using a ResScan Data Card Module” on page 23 for information about how to use the Data Card module and Data Card.

ACCESSORIES

Please refer to the illustrations in section **C** of the illustration sheet.

Other accessories for use with the S8 AUTOSET SPIRIT:

- Front cap (not available in all regions) (**C-2**)
- Air tubing 3 m (**C-3**)
- DC-12 converter (**C-4**)
- Blank module (**C-5**).

Note: ResMed regularly releases new products. Please check our website at www.resmed.com.

HOW TO USE THE S8 AUTOSET SPIRIT

Please refer to the illustrations in section **D** of the illustration sheet.

SET UP THE S8 AUTOSET SPIRIT

- 1 Place the S8 AUTOSET SPIRIT on a table near the head of your bed.



CAUTION

Be careful not to place the device where it can be bumped or where someone is likely to trip over the power cord.

Note: You can also place your S8 AutoSet Spirit on the floor beside or underneath your bed. Ensure that the area is free from dust and clear of bedding, clothes or any other objects that could block the air inlet.

- 2 Connect the power cord to the socket at the rear of the flow generator (**D-1**). Plug the other end of the power cord into the power outlet.



WARNING

Make sure the power cord and plug are in good condition and the equipment is not damaged.

- 3 Connect one end of the air tubing firmly onto the air outlet (**D-2**).



WARNING

- Only ResMed air tubing should be used with your flow generator. A different type of air tubing may alter the pressure you actually receive, reducing the effectiveness of your treatment.
- Blocking the air inlet or tubing while in operation could lead to overheating of the device.
- In the clinical environment any personal computer that is used with your CPAP system must be at least 1.5 m away from, or at least 2.5 m above, the patient. It must also comply with the relevant test standard. For personal computers the international standard is IEC 60950 or equivalent.

ASSEMBLE THE MASK

- 1 Assemble your mask system according to the mask user instructions.
- 2 Connect your mask system to the free end of the air tubing (**D-3**).
- 3 Check that the mask setting on the MASK screen is the one recommended for the mask you are using (see the table in "How to Select the Mask Type" on page 17). The S8 AUTOSET SPIRIT is now ready for use (**D-4**).

START TREATMENT

- 1 Make sure the power is on.
A welcome message is displayed briefly on the LCD screen, then the standby screen appears. In CPAP mode, the standby screen displays the word "RAMP". In AutoSet mode, the standby screen displays the word "SETTLING".
The key and LCD backlights also turn on.
- 2 Lie down and arrange the air tubing so that it is free to move if you turn in your sleep.



CAUTION

- Do not leave long lengths of air tubing around the top of your bed. They could twist around your head or neck while you are sleeping.
- Make sure the area around the flow generator is dry and clean. It should also be clear of bedding, clothes, and other potential blockages.

- 3 Alter the ramp or settling time if required (see "How to Change the Ramp or Settling Time" on page 15).
To start treatment, press the **Start/Stop** key, unless your clinician has set up your device to start delivering therapy automatically. If so, your device will start when you breathe into your mask (see "SmartStart" for details).
- 4 Fit your mask as described in the mask user instructions.



WARNING

A mask should not be used unless the S8 AUTOSET SPIRIT device is powered and operating properly.

- 5 When ramping (or settling) begins, the LCD will display the word "RAMPING", (or "SETTLING") with the current pressure indicated as dashes. Each dash is approximately equivalent to 2 cmH₂O. For example, 6 dashes represents approximately 12 cmH₂O pressure.

SMARTSTART™

The S8 AUTOSET SPIRIT has a function called SmartStart™ that your clinician can enable. If SmartStart is enabled, your device will start automatically when you breathe into your mask, and will stop automatically when you take your mask off. This means you do not have to press the **Start/Stop** key to begin or end treatment.

Note: Do not use SmartStart when using a mask with an anti-asphyxia valve, such as the Mirage Full Face Mask.

STOPPING TREATMENT

To stop treatment at any time, remove your mask and press the **Start/Stop** key
or
if your clinician has enabled SmartStart, simply remove your mask and treatment will end.

USING THE MASK-FITTING FEATURE

You can use the S8 AUTOSET SPIRIT mask-fitting feature to help you fit your mask properly. This feature delivers air pressure for a three-minute period, prior to starting treatment, during which you can check and adjust your mask fit to minimise leaks.

Note: Make sure that the mask setting on the MASK screen is the same as the mask you are using.

To use the mask-fitting feature:

- 1 Fit your mask as described in the mask user instructions.
- 2 Hold down the **Start/Stop** key for at least three seconds until air pressure delivery starts.

The following display will appear on the LCD screen indicating that the mask-fitting feature is operating. Your S8 device will ramp to the mask-fit pressure and will remain at this pressure for three minutes.

The LCD also displays a mask-fit star rating. See "Definitions of Mask-Fit Star Rating" on page 10.



Note: The mask-fit star rating display disappears after three minutes.

The mask-fitting feature can only be started from the RAMP or SETTling screen.

In AutoSet mode, the mask-fit pressure is the highest pressure that you are likely to receive based on the previous night's session or 10 cmH₂O, whichever is greater.

In CPAP mode, the mask-fit pressure is the set treatment pressure or 10 cmH₂O, whichever is greater.

- 3 Adjust your mask, mask cushion and headgear until you have a secure and comfortable fit.

Once you have a secure and comfortable fit, check your mask-fit star rating on the LCD screen. Table 4 explains the mask-fit star ratings.

Note: If there is another person nearby to check your mask-fit star rating, you can adjust your mask, mask cushion and headgear while lying down.

- 4 After three minutes, the pressure reverts to the set pressure and treatment will begin.
- If you do not wish to wait three minutes, hold down the **Start/Stop** key for at least three seconds to start treatment immediately.
 - If you press the **Start/Stop** key for less than three seconds, the unit will return to standby mode (the RAMP or SETTLING screen is displayed).

Table 1: Definitions of Mask-Fit Star Rating

Star rating	Definition
*****	Excellent
****_	Very good
***_ _	Good
**_ _ _	Adjust mask
*_ _ _ _	Adjust mask
_ _ _ _ _	Adjust mask

HOW TO ATTACH A HUMIDIFIER

ATTACH A HUMIDAIRE 3i HUMIDIFIER

*Please refer to the illustration in section **E** of the illustration sheet, and your HumidAire 3i manual.*

The HUMIDAIRE 3i attaches to the front of the S8 AUTOSET SPIRIT to provide heated humidification. No other accessories are required for its use.

Notes:

- a. Make sure the water chamber of the HumidAire 3i is empty before you attach or detach the humidifier.*
- b. Remove the connector plug on the S8 AutoSet Spirit before you attach the HumidAire 3i. Reattach the connector plug firmly after you detach the humidifier.*

STORING THE HUMIDAIRE 3i

Store the HUMIDAIRE 3i in the larger, mesh-top pouch of the S8 AUTOSET SPIRIT carry bag when not in use.

HOW TO USE THE KEYPAD

The control panel of the S8 AUTOSET SPIRIT includes an LCD screen and keypad for navigating through the menus and delivering treatment.

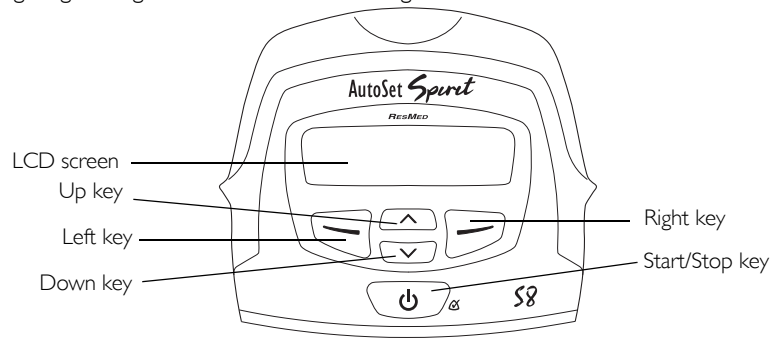

LCD SCREEN





The LCD screen displays the menus and treatment screens.



The LCD backlight turns off after two minutes of inactivity. It turns back on when you press a key.

KEYPAD KEYS

The S8 AUTOSET SPIRIT keypad has the following keys:

Key	Function
Start/Stop 	<ul style="list-style-type: none"> Starts or stops treatment. Extended hold (for at least three seconds) starts the mask-fitting feature.
Up 	<ul style="list-style-type: none"> Allows you to scroll through the S8 AutoSet Spirit menus and submenus, and increase the setting options.
Down 	<ul style="list-style-type: none"> Allows you to scroll through the S8 AutoSet Spirit menus and submenus, and decrease the setting options.
Left 	<ul style="list-style-type: none"> Performs the function indicated by the guiding text displayed above it on the LCD screen. Guiding text includes menu, change and apply.
Right 	<ul style="list-style-type: none"> Performs the function indicated by the guiding text displayed above it on the LCD screen. Guiding text includes exit and cancel.

When the **S8** device is in standby mode all keys remain lit. During therapy, the keypad backlight turns off after two minutes of inactivity and the **Start/Stop** key dims.

HOW TO CHANGE THE SETTINGS

You can change settings on the **S8 AUTOSET SPIRIT** by using the keypad and LCD. When the **S8 AUTOSET SPIRIT** is in standby mode you can display a series of screens (a menu) on the LCD screen in order to view and change the settings for a particular function.

Your clinician will preset the menu to either a standard view or a detailed view.

See “How to Use the Standard Menu” on page 17 and “How to Use the Detailed Menu” on page 19 for more information.

HOW TO ENTER THE MENU SCREENS

When the **S8 AUTOSET SPIRIT** standby (RAMP or SETTling) screen is displayed you will see the word “menu” in the left-hand corner. To select an **S8 AUTOSET SPIRIT** menu, press the **Left** key.

HOW TO SCROLL THROUGH THE MENU

When you are in the menu, scroll through items by pressing the **Up** or **Down** keys.

HOW TO CHANGE A SETTING OPTION

When you have scrolled to the item you require:

1. Press the **Left** key (Change).
2. Press the **Up** or **Down** keys until you see the setting option that you require.
3. Press the **Left** key (Apply) to select the setting option.

If you wish to exit without changing the option, press the **Right** key (Cancel).

HOW TO EXIT OUT OF A MENU

Press the **Right** key (Exit). This will take you back to the standby (RAMP or SETTling) screen.

HOW TO EXIT OUT OF AN ITEM WITHIN THE MENU

Press the **Right** key (Exit).

RAMP AND SETTling

If your clinician has set your **S8 AUTOSET SPIRIT** to CPAP mode, the RAMP screen is displayed after the Welcome screen. If your clinician has set your **S8 AUTOSET SPIRIT** to AutoSet mode, the SETTling screen is displayed after the Welcome screen.

Table 2: Ramp and Settling Functions

Screen	Function Description	Setting Options
Ramp (CPAP Mode only)	Selects the ramp time. Ramp time is the period during which the S8 AutoSet Spirit increases from a low pressure to the prescribed treatment pressure.	OFF–45 min; 5-minute increments
Settling (AutoSet Mode only)	Selects the settling time. Settling time is the period during which the S8 AutoSet Spirit maintains a minimum pressure before it starts to adjust pressure in response to respiratory events.	OFF–45 min; 5-minute increments

Note: The maximum ramp or settling time that you can set may be less than 45 minutes, depending on what your clinician has set as the maximum time.

HOW TO CHANGE THE RAMP OR SETTLING TIME

The standby screen displays the current ramp or settling time in the right-hand corner. To change the time, press the **Up** or **Down** key until the desired ramp or settling time appears.

HOW TO USE THE STANDARD MENU

Figure 1 shows the standard menu.

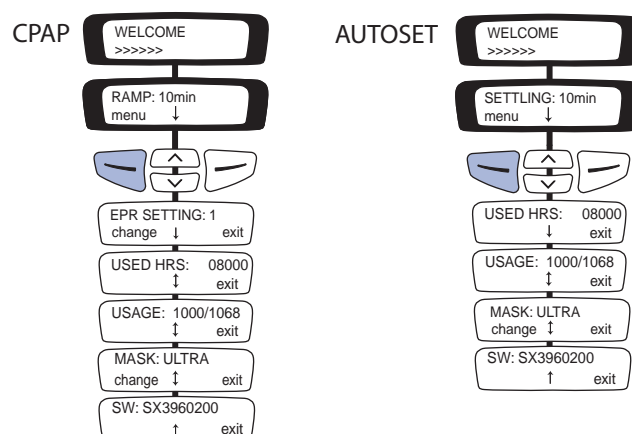

Figure 1 : Standard menu screens: CPAP and AutoSet modes

You enter the standard menu from the standby (RAMP or SETTLING) screen, by pressing the **Left** (Menu) key.

HOW TO CHANGE THE EXPIRATORY PRESSURE RELIEF SETTING

Note: EPR may not be available in all regions.

In CPAP mode, your clinician may have set up your device to deliver expiratory pressure relief (EPR). This can be used to help ease any discomfort you may experience when breathing out during treatment. There are four settings:

- OFF (no EPR)
- 1 (lowest EPR)
- 2
- 3 (highest EPR).

The EPR SETTING screen only appears if your clinician has enabled access to EPR settings. To change the EPR setting, select Change (**Left** key). Press the **Up** or **Down** keys until you see the setting that you require.

HOW TO SELECT THE MASK TYPE

Scroll to MASK and select Change (**Left** key). Press the **Up** or **Down** keys until you see the mask type that you require.

The following table shows the setting that should be selected for each mask type.

Table 3: Settings for mask types

Settings	Mask
ULTRA	Ultra Mirage Nasal Mask
MIR FULL	Mirage Full Face Mask Mirage Full Face Mask Series 2 Ultra Mirage Full Face Mask
ACTIVA	Mirage Activa Nasal Mask
SWIFT	Mirage Swift Nasal Pillows System
MIRAGE	Mirage Nasal Mask
STANDARD	Mirage Vista Nasal Mask Modular Nasal Mask Papillon

OTHER VIEWABLE INFORMATION

You can also view the the total number of hours of treatment (USED HRS); the number of sessions that the S8 AUTOSET SPIRIT was used in a usage period (USAGE); and the current software version (SW).

HOW TO USE THE DETAILED MENU

Figure 2 shows the detailed menu.

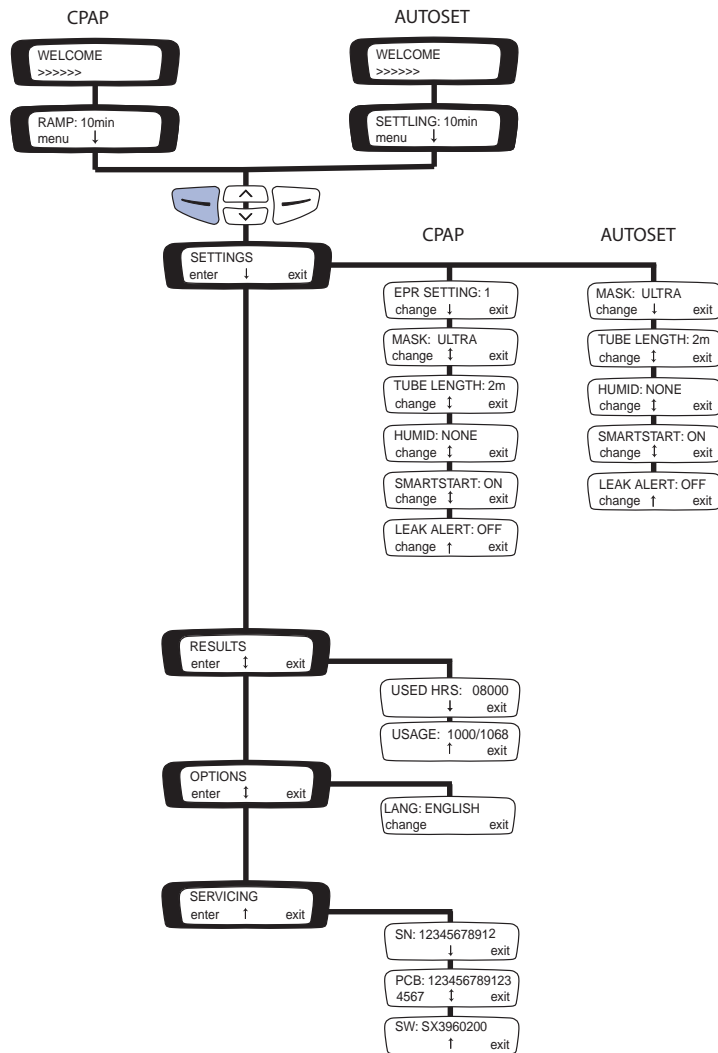

Figure 2 : Detailed menu screens

You enter the detailed menu from the standby (RAMP or SETTLING) screen, by pressing the **Left** (Menu) key. The SETTINGS menu screen is displayed.

SETTINGS MENU

Select Enter (**Left** key) on the Settings menu to access the options in this menu.

HOW TO CHANGE THE EXPIRATORY PRESSURE RELIEF SETTING

Note: EPR may not be available in all regions.

In CPAP mode, your clinician may have set up your device to deliver expiratory pressure relief (EPR). This can be used to help ease any discomfort you may experience when breathing out during treatment. There are four settings:

- OFF (no EPR)
- 1 (lowest EPR)
- 2
- 3 (highest EPR).

If you have access and want to change the EPR setting, scroll to EPR SETTING and select Change (**Left** key). Press the **Up** or **Down** keys until you see the setting that you require.

HOW TO SELECT THE MASK TYPE

Scroll to MASK and select Change (**Left** key). Press the **Up** or **Down** keys until you see the mask type that you require.

The following table shows the setting that should be selected for each mask type.

Table 4: Settings for mask types

Settings	Mask
ULTRA	Ultra Mirage Nasal Mask
MIR FULL	Mirage Full Face Mask Mirage Full Face Mask Series 2 Ultra Mirage Full Face Mask
ACTIVA	Mirage Activa Nasal Mask
SWIFT	Mirage Swift Nasal Pillows System
MIRAGE	Mirage Nasal Mask
STANDARD	Mirage Vista Nasal Mask Modular Nasal Mask Papillon

HOW TO CHANGE THE TUBE LENGTH

Scroll to TUBE LENGTH and select Change (**Left** key). Press the **Up** or **Down** keys until you see the tube length that you require.

HOW TO ADD A HUMIDIFIER OR FRONT CAP

Scroll to HUMID and select Change (**Left** key). Press the **Up** or **Down** keys until you see the setting that you require. You can use the device with or without a front cap.

HOW TO CHANGE THE SMARTSTART SETTING

SmartStart enables your device to start automatically when you breathe into the mask.

Scroll to SMARTSTART and select Change (**Left** key). Press the **Up** or **Down** keys

to change the option to ON or OFF.

HOW TO CHANGE THE LEAK ALERT SETTING

Leak alert indicates when a high mask leak is present.

Scroll to LEAK ALERT and select Change (**Left** key). Press the **Up** or **Down** keys to change the option to ON or OFF.

RESULTS MENU

Select Enter (**Left** key) on the Results menu to access the options in this menu.

Note: *Your clinician may have customised your device to display Smart Data. Contact your clinician for further details about Smart Data.*

VIEWING USAGE INFORMATION

You can view the total number of hours of treatment (USED HRS) and the number of sessions that the S8 AUTOSET SPIRIT was used in a usage period (USAGE).

OPTIONS MENU

Select Enter (**Left** key) on the Options menu to access the options in this menu.

HOW TO CHANGE THE LANGUAGE SETTING

Scroll to LANG and select Change (**Left** key). Press the **Up** or **Down** keys until you see the language that you require.

SERVICING MENU

Select Enter (**Left** key) on the Servicing menu to access the options in this menu.

You can view the current software version installed on your unit (SW); the serial number of the printed circuit board in your device (PCB); and the serial number of the device (SN).

MESSAGES ON THE S8 AUTOSET SPIRIT LCD

Your clinician may have set your S8 AUTOSET SPIRIT to remind you about important events, such as when to replace your mask, when to insert your Data Card (if your device is Data Card enabled) and so on.

The reminder message is displayed on the LCD and is visible if the device is not delivering therapy. The backlight on the LCD flashes when a message is displayed.

Your clinician can set any of the following reminders on your LCD:

Message	Description	Action
INSERT CARD	May appear if your device is Data Card enabled.	Insert your Data Card (see Section H of the illustrations sheet) and follow any instructions that your clinician has given you. When you have done this, the message will disappear from the LCD. Pressing the Left (Ok) key will also remove the message.
REPLACE MASK	May appear when your mask is due for replacement.	Press the Left (Ok) key to remove the message from your LCD, and replace your mask with a new one.
CALL PROVIDER*	May appear as a reminder to contact your clinician; for example to discuss how your therapy is going.	Press the Left (Ok) key to remove the message from your LCD, and contact your clinician.
REPLACE FILTER	May appear as a reminder to replace the air filter on your device.	Press the Left (Ok) key to remove the message from your LCD, and replace the air filter.
SERVICE DUE	May appear as a reminder to return your device for service.	Press the Left (Ok) key to remove the message from your LCD.
Customised messages	Your clinician may also set reminders for other reasons; for example to return equipment or to call a particular person or number.	Press the Left (Ok) key to remove the message from your LCD.

* "CALL CLINICIAN" in some countries.

S8 MODULES

Note: Do not remove modules while power is connected to the S8 AutoSet Spirit. Your S8 AUTOSET SPIRIT will have one of two modules fitted to the back: a blank module or a RESSCAN Data Card module.

USING A BLANK MODULE

Please refer to the illustrations in section **F** of the illustration sheet.

The blank module is a protective cover on your S8 AUTOSET SPIRIT. At times, you may wish to remove or attach the module, for example to use another module.

To *remove* the blank module, pull it off the back of the S8 CLASSIC to show the data communications port (**F-1**).

To *attach* the blank module, push the blank module onto the data communications port, until the module clicks into place (**F-2**).

Note: To protect the data communications port, always ensure there is a module attached to the back of the device.

USING A RESSCAN DATA CARD MODULE

Please refer to the illustrations in section **G** of the illustration sheet.

The RESSCAN Data Card module is an accessory to the S8 AUTOSET SPIRIT. Use a RESSCAN Data Card with the Data Card module to collect data and update settings in the S8 AUTOSET SPIRIT. The module and card give your clinician convenient access to data about your treatment, and can provide you with new device settings from your clinician without your having to leave home.

ATTACHING THE MODULE

To attach the Data Card module, push it onto the data communications port at the back of your S8 AUTOSET SPIRIT until it clicks into place (**G-1**).

REMOVING THE MODULE

To remove the Data Card module, pull it off the back of the S8 AUTOSET SPIRIT (**G-2**).

Note: To protect the data communications port, always ensure there is a module attached to the device.

USING THE DATA CARD TO COLLECT DATA

Please refer to the illustrations in section **H** of the illustration sheet.

If your clinician needs to review your treatment, they will ask you to use the Data Card to copy data from your S8 AUTOSET SPIRIT, and to return the card to them. The Data Card will be provided in a convenient mailback envelope.

Data that is copied to a Data Card is still stored and available on the S8 AUTOSET SPIRIT. It takes up to 30 seconds to copy data onto the Data Card.

1 INSERT THE DATA CARD

- Switch on the S8 AUTOSET SPIRIT and wait until you see the standby (RAMP or SETTling) screen.
- Hold the Data Card with the arrow facing up and insert it into the slot in the Data Card module (**H-1**).
- Push the card in smoothly until it stops moving (**H-2**) and messages start appearing on the LCD.

2 COPY DATA ONTO THE DATA CARD

- Data copying starts automatically when the Data Card is inserted into the Data Card module.
- The “Card Inserted Please Wait” message is displayed on the S8 AUTOSET SPIRIT LCD while data is being copied. Copying takes up to 30 seconds.
- The “Copy Complete Remove Card” message is displayed on the LCD when copying has finished.
- Remove the Data Card from the Data Card module.

3 REMOVE THE DATA CARD

Grip the end of the Data Card and pull it out of the Data Card module (**H-3**).

4 STORE THE DATA CARD

Your Data Card should be stored in its mailback envelope when not in use.

5 MAIL THE DATA CARD TO YOUR CLINICIAN

A bubble mailer envelope is provided to ensure safe transportation of the Data Card. When mailing the Data Card to your clinician:

1. Insert the Data Card into the pocket provided on the mailback envelope. Fold up the mailback envelope.
2. Place the mailback envelope containing the Data Card in the bubble mailer envelope and seal it.
3. Make sure that your clinician’s name and address details are on the bubble mailer envelope, and mail it back immediately.

USING THE DATA CARD TO UPDATE SETTINGS

If your clinician has provided a Data Card with new device settings:

- With the device in standby (RAMP or SETTling) mode, insert the Data Card into the slot on the Data Card module. Updating will start automatically.
- The “Card Inserted Please Wait” message is displayed on the LCD while updating is in progress. Updating takes up to 30 seconds.
- The “Settings Success Remove Card” message is displayed on the LCD if the settings were updated successfully.

Note: *This message only appears once. If you re-insert the Data Card after you have updated your settings, this message is not displayed.*

- Remove the Data Card from the Data Card module.
- Store the Data Card in its mailback envelope when not in use.

**WARNING**

If your clinician has told you to use this Data Card to update the settings on your device and the “Settings Success” message does not appear, contact your clinician immediately.

CLEANING AND MAINTENANCE

You should regularly carry out the cleaning and maintenance described in this section. Refer to your mask manual for detailed instructions.

DAILY CLEANING

MASK

Clean the mask according to the instructions supplied with the mask.

AIR TUBING

Disconnect the air tubing from the **S8 AUTOSET SPIRIT** (and humidifier, if used) and hang the tubing and mask in a clean, dry place until next use.

HUMIDIFIER

If you are using a humidifier, remove it from the **S8 AUTOSET SPIRIT** and clean it according to the instructions in the humidifier user's manual.

WEEKLY CLEANING

1. Remove the air tubing from the **S8 AUTOSET SPIRIT** and the mask.
2. Wash the air tubing in warm water using mild detergent. Rinse thoroughly, hang and allow to dry.
3. Before next use, assemble the mask and headgear according to the user instructions.
4. Reconnect the air tubing to the air outlet and mask.

PERIODIC CLEANING

1. Clean the exterior of the **S8 AUTOSET SPIRIT** with a damp cloth and mild liquid soap.
2. Check the air filter for blockage or holes (see "Replacing the Air Filter" on page 28).



WARNING

- Beware of electric shock. Do not immerse the unit or power cord in water. Always unplug the unit before cleaning and be sure it is dry before plugging back in.
- The mask system and air tubing are subject to normal wear and tear. Inspect them regularly for damage.

REPLACING THE AIR FILTER

To replace the air filter:

1. Remove the air filter cover at the back of the **S8 AUTOSET SPIRIT**.

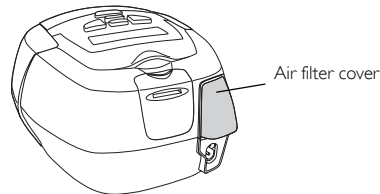

2. Remove and discard the old air filter.
3. Insert a new filter with the blue tinted side facing out from the device.
4. Replace the air filter cover.

Inspect the air filter every month to check if it is blocked by dirt or contains holes. With normal use of an **S8 AUTOSET SPIRIT**, the air filter needs to be replaced every six months (or more often if your device is in a dusty environment).



WARNING

- Do not wash the air filter. The air filter is not washable or reusable.
- The air filter cover protects the device in the event of accidental liquid spillage onto the device. Ensure the air filter and air filter cover are fitted at all times.

SERVICING



CAUTION

- Do not attempt to open the **S8 AutoSet Spirit** case. There are no user serviceable parts inside.
- Inspection and repair should only be performed by an authorised agent. Under no circumstances should you attempt to service or repair the flow generator yourself.

This product (**S8 AUTOSET SPIRIT**) should be inspected by an authorised ResMed service centre 5 years from the date of manufacture. Prior to this, the device is intended to provide safe and reliable operation provided that it is operated and maintained in accordance with the instructions provided by ResMed. Applicable ResMed warranty details are provided with the device at the time of original supply. Of course, as with all electrical devices, if any irregularity becomes apparent, you should exercise caution and have the device inspected by an authorised ResMed service centre.

If you feel that your flow generator is not performing properly, see "Troubleshooting" on page 31.

FREQUENTLY ASKED QUESTIONS

HOW WILL IT FEEL WHEN I AM BREATHING WITH THE S8 AUTOSET SPIRIT?

When you first use your S8 AUTOSET SPIRIT, you may feel uncomfortable breathing against the airflow. This is normal. You will continue to breathe normally while you sleep. Take time to adjust to this new sensation.

WHAT DO I DO WHEN I WANT TO GET UP IN THE NIGHT?

If you need to get up during the night, remove your mask and stop therapy. Always remember to restart therapy and put your mask on when you return to bed.

WHAT DO I DO IF I FEEL AIR LEAKING OUT OF THE MASK?

The flow generator delivers the most effective treatment when the mask is well fitted and comfortable. Treatment can be affected by leaks, so it is important to eliminate any leaks that may arise. For example, try repositioning the mask and adjusting the straps.

If you are using a nasal mask, try to keep your mouth closed during treatment. Air leaks from your mouth can decrease the effectiveness of your treatment. If mouth leaks are a problem, a full face mask or chin strap may help. Contact your clinician or equipment supplier for further details.

If you are using a full face mask and you have problems trying to get a comfortable mask fit, contact your sleep clinic or equipment supplier. You may benefit from a different size or style of mask.

You can also use the mask-fitting feature to help you fit your mask properly. See “Using the Mask-Fitting Feature” on page 9

ANYTHING SPECIAL I SHOULD DO BEFORE PUTTING THE MASK ON?

Before wearing your mask, wash your face to remove excess facial oils. This will allow a better fit and prolong the life of the mask cushion.

Do not use moisturiser when wearing a mask.

MY MOUTH FEELS DRY DURING TREATMENT—WHAT CAN I DO?

You may experience dryness of the nose, mouth and/or throat during the course of treatment, especially during winter. In many cases, a humidifier may resolve this discomfort. Contact your clinician for advice.

MY NOSE IS IRRITATED DURING TREATMENT—WHAT CAN I DO?

You may experience sneezing and/or a runny or blocked nose during the first few weeks of treatment. In many cases, nasal irritation can be resolved with a humidifier. Consult your clinician or equipment supplier for advice.

CAN I TRAVEL WITH THE S8 AUTOSET SPIRIT?

INTERNATIONAL USE

Your S8 AUTOSET SPIRIT flow generator has an internal power supply that enables it to operate in other countries. It will operate on power supplies of 100–240 V and 50/60 Hz. No special adjustment is necessary, but you may need a plug adapter for the power outlet.

ALTITUDE CHANGES

Your S8 AUTOSET SPIRIT automatically adjusts to changes in altitude up to 2591 m.

ON AN AIRCRAFT

Please consult the medical services department of your carrier if you intend to use your S8 AUTOSET SPIRIT on an aircraft. The S8 AUTOSET SPIRIT complies with US FCC Part 15, Class B requirements if no external data cables are used.

Note: *Do not use your S8 AUTOSET SPIRIT while the aircraft is taking off or landing.*

CAN I USE MY S8 AUTOSET SPIRIT IF MAINS (AC) POWER IS NOT AVAILABLE?

You must use a ResMed DC-12 converter to connect the S8 AUTOSET SPIRIT to a 12 V or 24 V DC power source. Contact your equipment supplier or ResMed for details.

**WARNING**

The device should not be connected to both AC and DC power sources simultaneously.

TROUBLESHOOTING

If there is a problem, try the following suggestions. If the problem cannot be solved, contact your equipment supplier or ResMed. Do not attempt to open the device.

Problem	Possible Cause	Solution
<i>No display.</i>	Power not connected.	Ensure the appropriate power cord is connected to your S8 AutoSet Spirit and the power switch (if available) is on.
<i>Insufficient air delivered from S8 AutoSet Spirit.</i>	Ramp or settling time is in use.	Wait for air pressure to build up or change ramp or settling time.
	Air filter is dirty.	Replace air filter.
	Air tubing is kinked or punctured.	Straighten or replace tubing.
	Air tubing not connected properly.	Check air tubing.
	Mask and headgear not positioned correctly.	Adjust position of mask and headgear.
	Cap(s) missing from access port(s) on mask.	Replace cap(s).
<i>S8 AutoSet Spirit does not start when you breathe into the mask.</i>	Pressure required for treatment may have changed.	See your clinician to adjust the pressure.
	Power cord not connected properly.	Connect power cord firmly at both ends.
	Power outlet may be faulty.	Try another power outlet.
	SmartStart not on.	Enable SmartStart.
	Leak Alert has been enabled; SmartStart has automatically been disabled.	Disable Leak Alert to enable SmartStart.
	Use of a Mirage or Ultra Mirage Full Face Mask.	SmartStart does not work with a full face mask as the anti-asphyxia valve will not allow sufficiently high pressure on exhalation.
Breath is not deep enough to trigger SmartStart.	Take a deep breath in and out through the mask.	

Problem	Possible Cause	Solution
	There is excessive leak.	Adjust position of mask and headgear. Caps may be missing from ports on mask. Replace them. Air tubing not connected properly. Connect firmly at both ends. Air tubing kinked or punctured. Straighten or replace.
<i>S8 AutoSet Spirit unit does not stop when you remove your mask.</i>	SmartStart/Stop is disabled.	Enable SmartStart/Stop.
<i>SmartStart is enabled but the flow generator does not stop automatically when you remove your mask.</i>	Incompatible humidifier or mask system being used.	Use only equipment as recommended and supplied by ResMed.
<i>Pressure rises inappropriately.</i>	Talking, coughing, voluntarily breath-holding (eg while rolling over in bed), or intentionally breathing in an unusual manner.	Avoid talking with a nasal mask on, and breathe as normally as possible.
	Mask cushion is buzzing against the skin. Cushion seated incorrectly.	Adjust the headgear.
	Cushion seated incorrectly causing excessive leak.	Adjust headgear or re-fit cushion.
	Air tubing is kinked or punctured.	Straighten or replace air tubing.
	Humidifier control dial set too high, resulting in accumulation of water in the air tubing.	Turn humidifier control dial down and empty the water from the air tubing.

Problem	Possible Cause	Solution
<p><i>Display error message:</i> Check tube!! Key if done</p>	The air tubing is loose or blocked.	<p>Check that the air tubing is connected securely to your mask and the air outlet on the front of the S8 AutoSet Spirit.</p> <p>When you have checked the air tubing, press the Start/Stop key to restart the device.</p> <p>If this does not clear the message, disconnect the power cord and then reconnect it to restart the device.</p>
<p><i>Display error message:</i> SYSTEM ERROR Call service!</p>	Component failure.	Return your S8 AutoSet Spirit for servicing.
<p><i>Display error message:</i> High leak in last session</p>	You have experienced excessively high leak levels during the night.	<p>Check that your air tubing is connected properly and that your mask does not leak excessively. Use the mask-fitting feature to help you to fit your mask properly.</p> <p>If this message appears again, contact your clinician.</p>
<p><i>Display error message:</i> HIGH LEAK!!! Adjust Mask</p>	You have experienced excessively high leak levels for more than 20 seconds.	<p>Check that your air tubing is connected properly and that your mask does not leak excessively. Use the mask-fitting feature to help you to fit your mask properly.</p> <p>If this message appears again, contact your clinician.</p>
<p><i>Display error message:</i> Exxxxx (where xxxxx defines an error)</p>	Component failure.	Return your S8 AutoSet Spirit for servicing.
<p><i>The following message is displayed on the LCD after you try to update settings using the Data Card:</i> Card Error Remove Card</p>	The Data Card is not inserted correctly.	<p>Ensure that the Data Card is inserted with the arrow facing up and pointing towards the device. Ensure that the device is switched on and in standby mode before you insert the Data Card.</p>
	The Data Card is only partly inserted.	Ensure that the Data Card is inserted into the slot on the Data Card module as far as it will go.

Problem	Possible Cause	Solution
	You may have removed the Data Card before settings were copied to the S8 AutoSet Spirit.	Reinsert the Data Card and wait for the Settings Success Remove Card message to appear on the LCD.
	The card is not a ResScan Data Card.	Only use a ResScan Data Card.
<i>The following message is displayed on the LCD after you try to copy data to a Data Card:</i> Card Error Remove Card	The Data Card is not inserted correctly.	Ensure that the Data Card is inserted with the arrow facing up and pointing toward the device.
	The card is not a ResScan Data Card.	Use a ResScan Data Card, as specified in this manual.
	You may have removed the Data Card before data was copied to it.	Reinsert the Data Card and wait for the Copy Complete Remove Card message to appear on the LCD.
<i>The following message is displayed on the LCD after you try to update the settings using the Data Card:</i> Settings Invalid Remove Card	The identification details on the Data Card do not match the details on your device.	Contact your clinician immediately.
<i>The following message is displayed on the LCD after you try to update the settings using the Data Card:</i> Settings Error Remove Card	There is a data error on the Data Card.	Contact your clinician immediately.
<i>The following message is NOT displayed on the LCD after you try to update the settings using the Data Card:</i> Settings Success Remove Card	The settings were not updated.	Contact your clinician immediately.

SYSTEM SPECIFICATIONS

S8 AUTOSET SPIRIT (NO ACCESSORIES)

Performance: Operating pressure range: 4 to 20 cmH₂O

Dimensions (H x W x D): 112 mm x 164 mm x 145 mm

Weight: 1.3 kg

Power Supply

- Input range for S8 AUTOSET SPIRIT with HUMIDAIRE 3i: 100–240 V, 50/60 Hz; 110 V, 400 Hz; 2.5A <140 VA (110 W) (maximum power consumption). Instantaneous peak power consumption <340 VA.
- Refer to the DC-12 converter instructions for DC ratings. Only use the ResMed DC-12 converter for DC input.

Actual power consumption will vary, depending on factors such as the use of accessories, height above sea level and ambient temperature. Power consumption values for typical treatment conditions (using a breathing machine set to 0.5 L and 15 breaths/min with 2 m air tubing and an ULTRA MIRAGE mask) are given in the following table:

Device	Pressure (cmH ₂ O)	Power (VA)	Power (W)
S8 AutoSet Spirit	5	18	7.6
	10	23	11.6
	15	30	15.9
	20	39	20.7

Power outlet for HumidAire 3i

Outlet range: 100–240 V, 50/60 Hz; 110 V, 400 Hz; 2.0A

Air Filter: Two-layered, powder-bonded, polyester non-woven fiber

Air Tubing: Flexible plastic, 2 m

Air Outlet: The 22 mm conical air outlet complies with EN 1281-1

IEC 60601-1 Classifications: Class II (double insulation), Type CF

Noise level: Radiated sound pressure is measured at <30 dBA at 10 cmH₂O and 1 m according to ISO17510

ACCESSORIES

DATA CARD

Dimensions (L x W x D): 65.04 mm x 22.15 mm x 0.85 mm

DATA CARD MODULE

Dimensions (H x W x D): 49.7 mm x 42.2 mm x 12 mm

ALL DEVICES (WHERE APPLICABLE)

Housing Construction: Flame retardant engineering thermoplastic

Environmental Conditions

Operating Temperature: +5°C to +40°C

Operating Humidity: 10%–95% non-condensing

Storage and Transport Temperature: -20°C to +60°C

Storage and Transport Humidity: 10%–95% non-condensing

Operating Altitude: sea level to 2591 m

Electromagnetic Compatibility

Product complies with all applicable electromagnetic compatibility requirements (EMC) according to IEC60601-1-2, for residential, commercial, and light industry environments. For further details, see "Guidance and Manufacturer's Declaration - Electromagnetic Emissions and Immunity" on page 37.

Note: *The manufacturer reserves the right to change these specifications without notice.*

SYMBOLS WHICH APPEAR ON THE DEVICE



Attention, consult accompanying documents



Type CF equipment



Class II equipment



IPX1

Drip proof



Dangerous voltage



Start/Stop and mask-fit

GUIDANCE AND MANUFACTURER'S DECLARATION - ELECTROMAGNETIC EMISSIONS AND IMMUNITY

Guidance and manufacturer's declaration—electromagnetic emissions

The S8 series of devices is intended for use in the electromagnetic environment specified below. The customer or the user of the S8 device should assure that the device is used in such an environment.

Emissions test	Compliance	Electromagnetic environment—guidance
RF emissions CISPR11	Group 1	The S8 device uses RF energy only for its internal function. Therefore, its RF emissions are very low and are not likely to cause any interference in nearby electronic equipment.
RF emissions CISPR 11 with serial adapter	Class B*	The S8 device is suitable for use in all establishments, including domestic establishments and those directly connected to the public low-voltage network that supplies buildings used for domestic purposes.
RF emissions CISPR 11 with USB adapter	Class B	
Harmonic Emissions IEC 61000-3-2	Class A	
Voltage Fluctuations/Flicker Emissions IEC 61000-3-3	Complies	

* Class B for all system configurations except when a PC is attached to the S8 device via a serial adapter, in which case the system is Class A compliant. Class A is suitable for use in all establishments other than domestic and those directly connected to a low voltage power supply network which supplies buildings used for domestic purposes.

Medical Electrical Equipment needs special precautions regarding EMC and needs to be installed and put into service according to EMC information provided in this document.

Warnings: The S8 device should not be used adjacent to or stacked with other equipment. If adjacent or stacked use is necessary, the S8 device should be observed to verify normal operation in the configuration in which it will be used.

The use of accessories (eg humidifiers) other than those specified in this manual is not recommended. They may result in increased emissions or decreased immunity of the S8 device.

Guidance and manufacturer's declaration—electromagnetic immunity

The S8 series of devices is intended for use in the electromagnetic environment specified below. The customer or the user of the S8 device should assure that the device is used in such an environment.

Immunity test	IEC60601-1-2 test level	Compliance level	Electromagnetic environment—guidance
Electrostatic discharge (ESD) IEC 61000-4-2	±6 kV contact ±8 kV air	±6 kV contact ±8 kV air	Floors should be wood, concrete or ceramic tile. If floors are covered with synthetic material, the relative humidity should be at least 30%.
Electrical fast transient/burst IEC 61000-4-4	±2 kV for power supply lines ±1 kV for input/output lines	±2 kV Not Applicable	Mains power quality should be that of a typical commercial or hospital environment.
Surge IEC 61000-4-5	±1 kV differential mode ±2 kV common mode	±1 kV differential mode ±2 kV common mode	Mains power quality should be that of a typical commercial or hospital environment.
Voltage dips, short interruptions and voltage variations on power supply input lines. IEC 61000-4-11	<5% U_t (>95% dip in U_t) for 0.5 cycle 40% U_t (60% dip in U_t) for 5 cycles 70% U_t (30% dip in U_t) for 25 cycles <5% U_t (>95% dip in U_t) for 5 sec	< 12 V (>95% dip in 240 V) for 0.5 cycle 96 V (60% dip in 240 V) for 5 cycles 168 V (30% dip in 240 V) for 25 cycles <12 V (>95% dip in 240 V) for 5 sec	Mains power quality should be that of a typical commercial or hospital environment. If the user of the S8 device requires continued operation during power mains interruptions, it is recommended that the S8 device be powered from an uninterruptible power source.
Power frequency (50/60 Hz) magnetic field IEC 61000-4-8	3 A/m	3 A/m	Power frequency magnetic fields should be at levels characteristic of a typical location in a typical commercial or hospital environment.

NOTE: U_t is the AC mains voltage prior to application of the test level.

Guidance and manufacturer's declaration—electromagnetic immunity

The S8 series of devices is intended for use in the electromagnetic environment specified below. The customer or the user of the S8 device should assure that the device is used in such an environment.

Immunity test	IEC60601-1-2 test level	Compliance level	Electromagnetic environment—guidance
Conducted RF IEC 61000-4-6	3 Vrms 150 kHz to 80 MHz	3 Vrms	<p>Portable and mobile RF communications equipment should be used no closer to any part of the S8 device, including cables, than the recommended separation distance calculated from the equation applicable to the frequency of the transmitter.</p> <p>Recommended separation distance</p> <p>$d = 1.17 \sqrt{P}$</p> <p>$d = 0.35 \sqrt{P}$ 80 MHz to 800 MHz</p> <p>$d = 0.70 \sqrt{P}$ 800 MHz to 2.5 GHz</p> <p>where P is the maximum output power rating of the transmitter in watts (W) according to the transmitter manufacturer and d is the recommended separation distance in meters (m). Field strengths from fixed RF transmitters, as determined by an electromagnetic site survey,^a should be less than the compliance level in each frequency range.^b</p> <p>Interference may occur in the vicinity of equipment marked with the following symbol:</p> 
Radiated RF IEC 61000-4-3	10 V/m 80 MHz to 2.5 GHz	10 V/m	

NOTE 1: At 80 MHz and 800 MHz, the higher frequency range applies.

NOTE 2: These guidelines may not apply in all situations. Electromagnetic propagation is affected by absorption and reflection from structures, objects and people.

^a Field strengths from fixed transmitters, such as base stations for radio (cellular/cordless) telephones and land mobile radios, amateur radio, AM and FM radio broadcast and TV broadcast cannot be predicted theoretically with accuracy. To assess the electromagnetic environment due to fixed RF transmitters, an electromagnetic site survey should be considered. If the measured field strength in the location in which the S8 device is used exceeds the applicable RF compliance level above, the S8 device should be observed to verify normal operation. If abnormal performance is observed, additional measures may be necessary, such as reorienting or relocating the S8 device.

^b Over the frequency range 150 kHz to 80 MHz, field strengths should be less than 10 V/m.

Recommended separation distances between portable and mobile RF communications equipment and the S8 series of devices

The S8 series of devices is intended for use in an environment in which radiated RF disturbances are controlled. The customer or the user of the S8 device can help prevent electromagnetic interference by maintaining a minimum distance between portable and mobile RF communications equipment (transmitters) and the S8 device as recommended below, according to the maximum output power of the communications equipment.

Rated maximum output power of transmitter W	Separation distance according to frequency of transmitter m		
	150 kHz to 80 MHz $d = 1.17 \sqrt{P}$	80 MHz to 800 MHz $d = 0.35 \sqrt{P}$	800 MHz to 2.5 GHz $d = 0.7 \sqrt{P}$
0.01	0.17	0.04	0.07
0.1	0.37	0.11	0.22
1	1.17	0.35	0.7
10	3.69	1.11	2.21
100	11.70	3.50	7

For transmitters rated at a maximum output power not listed above, the recommended separation distance d in metres (m) can be determined using the equation applicable to the frequency of the transmitter, where P is the maximum output power rating of the transmitter in watts (W) according to the transmitter manufacturer.

NOTE 1: At 80 MHz and 800 MHz, the separation distance for the higher frequency range applies.

NOTE 2: These guidelines may not apply in all situations. Electromagnetic propagation is affected by absorption and reflection from structures, objects and people.

LIMITED WARRANTY

ResMed warrants that your ResMed product shall be free from defects in material and workmanship for the period specified below from the date of purchase by the initial consumer. This warranty is not transferable.

Product	Warranty Period
ResMed humidifiers, ResControl™, ResLink™	1 Year
ResMed flow generators	2 Years
Accessories, mask systems (including mask frame, cushion, headgear and tubing). Excludes single-use devices.	90 Days

Note: Some models are not available in all regions.

If the product fails under conditions of normal use, ResMed will repair or replace, at its option, the defective product or any of its components. This Limited Warranty does not cover:

- a) any damage caused as a result of improper use, abuse, modification or alteration of the product;
- b) repairs carried out by any service organization that has not been expressly authorized by ResMed to perform such repairs;
- c) any damage or contamination due to cigarette, pipe, cigar or other smoke;
- d) any damage caused by water being spilled on or into a flow generator.

To make a warranty claim, the initial consumer must return the defective product to the point of purchase, freight prepaid.

This warranty is in lieu of all other express or implied warranties, including any implied warranty of merchantability or fitness for a particular purpose. Some regions or states do not allow limitations on how long an implied warranty lasts, so the above limitation may not apply to you.

ResMed shall not be responsible for any incidental or consequential damages claimed to have occurred as a result of the sale, installation or use of any ResMed product. Some regions or states do not allow the exclusion or limitation of incidental or consequential damages, so the above limitation may not apply to you. This warranty gives you specific legal rights, and you may also have other rights which vary from region to region.

For further information on your warranty rights, contact your local ResMed dealer or ResMed office..

R001-307/6 05 02

INDEX

A

- accessories 6
- air filter 5, 31
 - replacing 28
- air pressure 31
- air tubing 5
 - cleaning 27
 - connect to air outlet 7
 - kinked 31
 - positioning 8
- aircraft 30
- airflow
 - breathing with 29

B

- blank module 23

C

- carry bag 5
- cleaning
 - daily 27
 - periodic 27
 - weekly 27
- contraindications 1

D

- daily cleaning 27
- Data Card 23, 33
 - copying data 24
 - inserting 24
 - mailback envelope 24
 - removing 24
- Data Card module 6, 23
- data management products 23
- DC-12 converter 30
- detailed menu 19
- down key 13
- dryness
 - mouth, nose or throat 29

E

- EPR setting 17, 20
- error messages 33
- expiratory pressure relief 17, 20

F

- frequently asked questions 29
- front cap 6, 20

H

- headgear position 31
- HumidAire 3i 6
 - attaching 11
 - storage 5, 11
- humidifiers
 - alleviating dryness 29
 - cleaning 27
 - HumidAire 3i 6
 - type 20

I

- international use 29

K

- keypad 5
 - key functions 13

L

- language setting 21
- LCD 5, 8, 13
 - error messages 34
 - messages 21
- leak alert setting 21
- left key 13

M

- mailback envelope 24
- mask
 - air leak 29
 - attaching 7
 - cleaning 27
 - mask type 17, 20
 - port 31
 - position 31
 - preparing to use 29
 - removing 29
 - types 5, 6
- Mask screen 9
- mask settings 18, 20
- mask types 18, 20
- mask-fit 9
 - star rating 10
- medical information 1
- menu
 - detailed 19
 - standard 17
- menu screens 14

- access 14
- change 14
- exit 14
- scrolling 14
- modules
 - attaching 5
 - blank 23
 - Data Card 23

N
nasal irritation 29

O
Options Menu 21

P
PCB

- serial number 21
- periodic cleaning 27
- power cord 5, 31
 - connecting 7
- power sockets 5
- power sources 30
- power supply 35
- printed circuit board 21

R
Ramp screen 14
ramp time 8, 31
reminders 22

- call provider 22
- customised messages 22
- insert card 22
- replace air filter 22
- replace mask 22
- service due 22

ResScan Data Card module 6
Results Menu 21
right key 13

S
S8 AutoSet Spirit

- dimensions 35, 36
- servicing 28
- setup 7
- start treatment 8
- travelling with 29

S8 modules 23
serial number 21
Servicing Menu 21
setting up 7

Settings Menu 19
settling time 31
SmartStart 8
SmartStart setting 20
SN 21
software version 18, 21
software version number 21
standard menu 17
standby screen 8
start/stop key 13
stopping treatment 9
SW 21
system specifications 35

T
troubleshooting 31
tube length setting 20

U
up key 13
Usage 18, 21
use on aircraft 30
Used hours 18, 21

W
weekly cleaning 27