



Full Control at Your Finger Tips

**UTAdvanced**<sup>®</sup>

**Digital Indicating Controllers**  
UT55A/UT52A/UT35A/UT32A

**Digital Indicating Controller**  
UT75A **NEW** Please see Bulletin 05P01B41-01EN.

**Program Controllers**  
UP55A/UP35A

**Digital Indicator with Alarms**  
UM33A

Bulletin 05P01A01-01EN

[www.utadvanced.com](http://www.utadvanced.com)

**vigilantplant**<sup>®</sup>  
The clear path to operational excellence

YOKOGAWA 

# INTRODUCING THE **UTAdvanced**®



## **Balancing Simplicity and Power**

The UTAdvanced was designed as a result of knowledge obtained in Yokogawa's fifty plus years of experience in the control market. Significant changes in the market are setting the tone for the future and Yokogawa will be leading the way meeting the challenging needs of the control segment. Balancing an easy to use controller with the power to handle your most challenging applications, that's the UTAdvanced.



# features

## Advanced Control

PID Control — 8 Built-in Control Modes  
— 8 Built-in Control Types

Ladder Sequence Control

Fuzzy Logic Control

## Simplicity

Bright & Easy to Read Active Color LCD Display  
Scrolling Text

Navigation Guide & Navigation Keys

Programmable Function Keys

User Settable Default Values

Multiple Language Support

Compact Design

## Networking

Ethernet (Modbus/TCP)

RS-485 (Modbus/RTU, Peer to Peer, Coordinated Operation, PC-Link)

Open Network (PROFIBUS-DP, CC-Link, DeviceNet)

## Reliability

3 Year Warranty \*Note 1

RoHS/WEEE

NEMA4\*Note 2/IP66 Front Panel

RCM marking

KC marking

Note 1 : The 3 year warranty extends 36 months after shipment from our factory.

Note 2 : Hose down test only.



CSA C22.2 61010-1

172608



UL61010-1





# Advanced Control

## 8 Built-in Control Modes

The control mode allows easily configuring settings and making changes with parameters.

- Single-loop control
- Cascade primary-loop control
- Cascade secondary-loop control
- Cascade control
- Loop control for backup
- Loop control with PV switching
- Loop control with PV auto-selector
- Control with PV-hold function

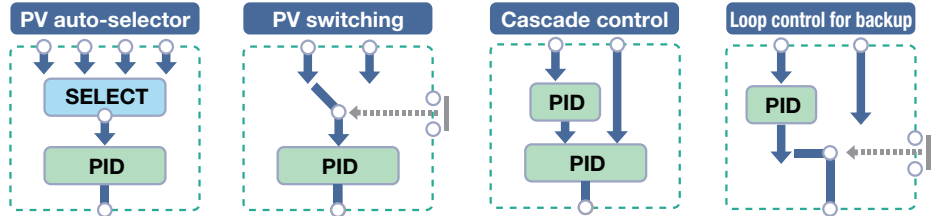

## 8 Built-in Control Types

- PID control
- ON/OFF control (1 point of hysteresis)
- ON/OFF control (2 points of hysteresis)
- Two-position, two-level control
- Heating/cooling control
- Sample PI control
- Batch PID control
- Feedforward control

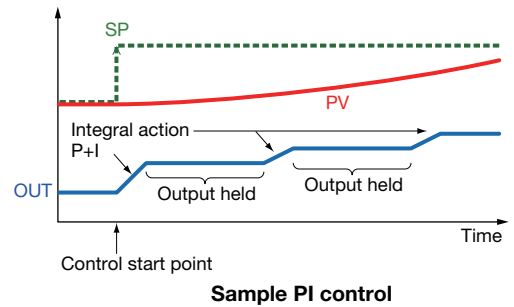
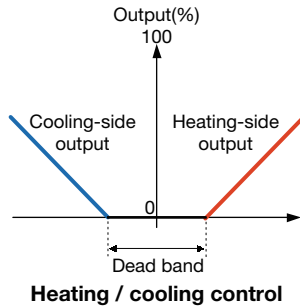

For the correspondence between the above control mode and control types for each model, please refer to the specifications of each model.

## Ladder Sequence Control

With built-in ladder sequence control, the range of applications are dramatically increased. This feature is standard in all the UTAdvanced controllers (except UM33A). The ladder sequence control function can replace a small PLC required by the application. Sequence control and PID control can be performed simultaneously.

- Monitoring and control of external machinery  
Eg. Lamps, switches, timers
- Solve digital input / output logic functionality easily.  
Number of basic instruction types : 13 or more  
Number of application instruction types : 73 or more

Name	Symbol
Load	
Set	
Timer	
Counter	
Compare	
Logic	
Data transfer	
High selector	
Temperature correction	

\* LL50A Parameter Setting Software (sold separately) is required to build functions.

## Ladder sequence Control

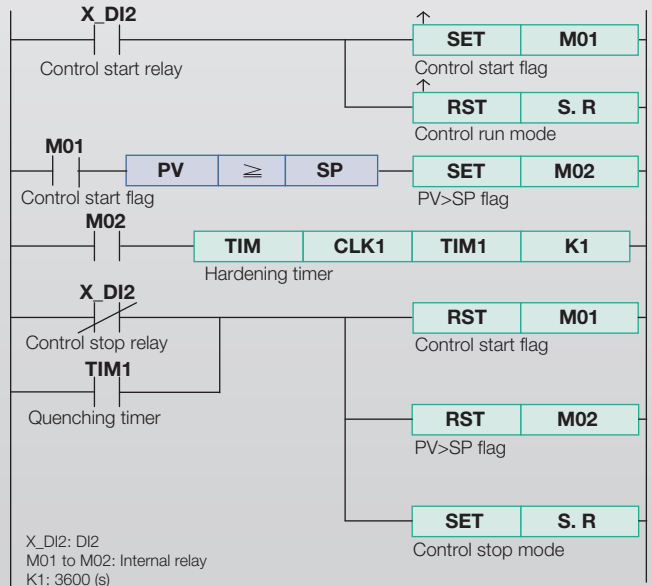
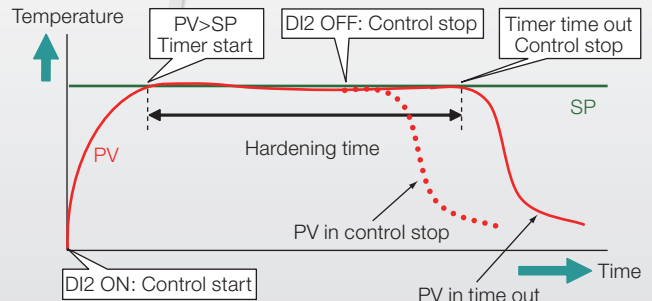

X\_DI2: DI2  
M01 to M02: Internal relay  
K1: 3600 (s)

# Application Examples of Ladder Sequence Program

## Alarm Sequence Control Circuits Can be Reduced

The ladder sequence program is built in the UTAdvanced as standard. The ladder sequence function enables monitoring and controlling peripheral devices such as relays, thus making it possible to reduce costs.

### Conventional

Alarm action was built by a sequence control circuit (relay, timer, etc.) outside of the controller.

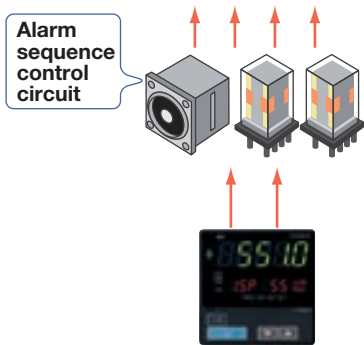

### UTAdvanced

Alarm action is built by the ladder sequence program inside the UTAdvanced, thus making it possible to reduce costs.

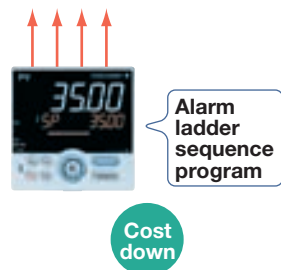

### Example: Alarm annunciator

#### Action explanation

- Lamp blinks when alarm occurs
- Lamp turns on by acknowledgment when alarm is on
- Lamp turns off by acknowledgment when alarm is off

Alarm acknowledgment by function key



#### Time Chart

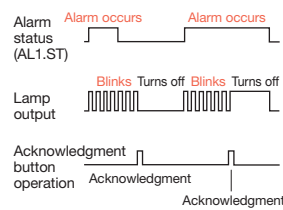

#### Alarm Ladder Sequence Program

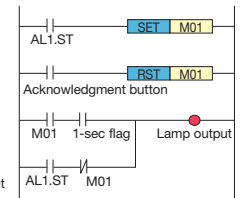

## Host System Load is Reduced

### Conventional

Action: Various types of analog data were captured into the host system (PLC, etc.) and calculated, and the results were processed by the field controller for control via a command.



### UTAdvanced



The UTAdvanced with up to 4 analog inputs enables various types of analog data to be captured directly into the controller and calculated by the ladder program, thus reducing the system-building load of the host.

## Fuzzy Logic

### SUPER Function suppresses overshoot

The field-proven SUPER function utilizes a built-in operator experience and fuzzy theory to deliver fine control and suppress overshoot.

- When wishing to suppress overshoot
- When wishing to reduce the startup time
- When load changes are significant
- When setpoint is changed frequently

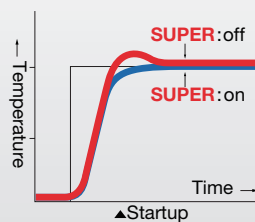

## Fuzzy Logic

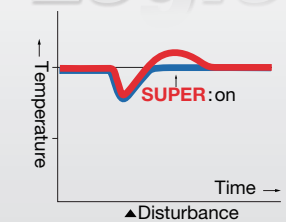
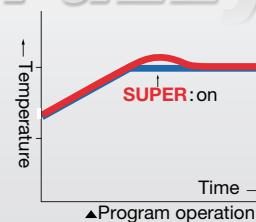

### SUPER2 Function suppresses hunting

The new SUPER2 function utilizes a built-in operator experience and modern control theory to deliver fine control and suppress hunting.

#### Effect 1: Material change or load change with the same PID.

When SUPER2 function is not used

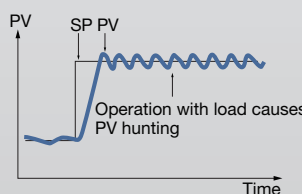

When SUPER2 function is used

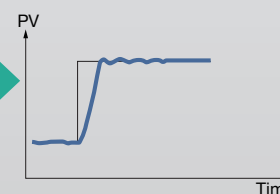

#### Effect 2: Setpoint (SP) change with the same PID.

When SUPER2 function is not used

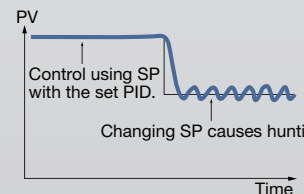

When SUPER2 function is used

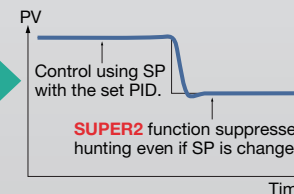



# Simplicity

## Digital Indicating Controller UT55A / UT52A / UT35A / UT32A

### Bright & Easy to Read Active Color LCD Display

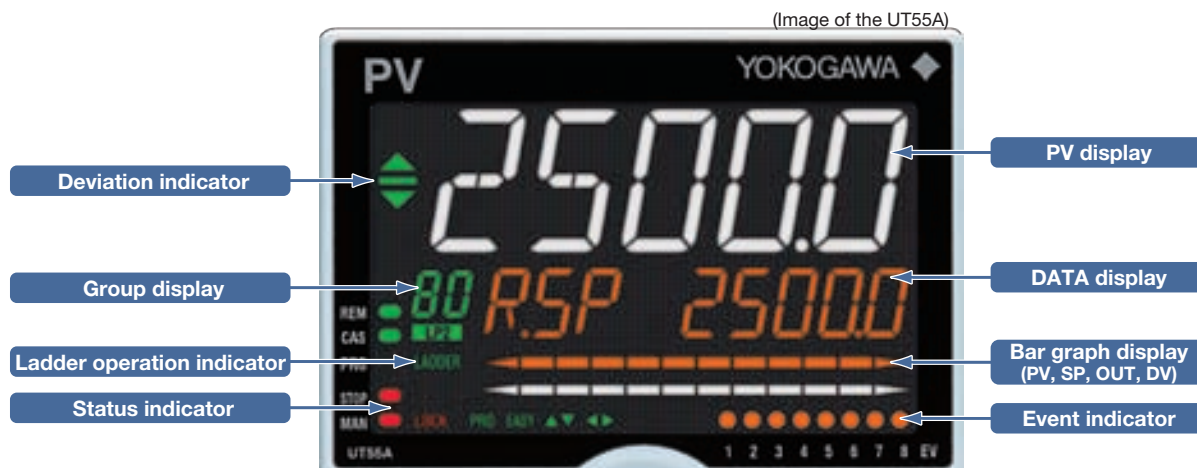

### Optimal Display

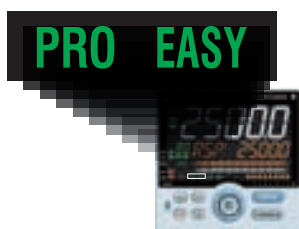

The controller menus and layout are adjusted in accordance with the level (EASY, STD, PRO) of information required by the user. If simple temperature or level control is needed, then select the easy configuration. Very sophisticated applications are no problem for the UTAdvanced. Just select the PRO setting and make use of the additional functionality shown in this mode. Advanced applications can be programmed in the PRO setting and then changed back to the easy setting to lock out functions not required by operators.

### Active Color LCD Display

With Yokogawa's active color display you can instantly tell, at a glance, the status of your process.

Alarm Status : Active color display changes from white (normal) to red (alarm).

Deviation Status : Color changes based on a PV deviation from SP.

User-defined Color : Choose between white or red display for constant readings.



### Compact Design

The 65-mm depth of the controller reduces the constraints on installation location.

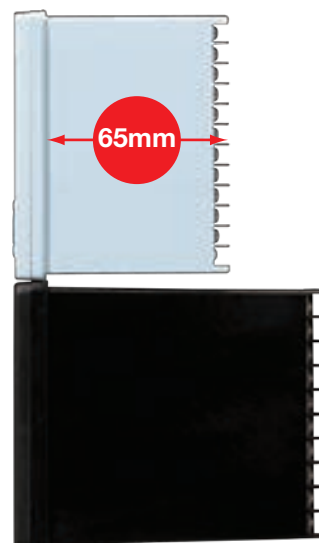

# Program Controller UP55A / UP35A

## Versatile Color LCD Display



## Operation Displays of the Program Controller

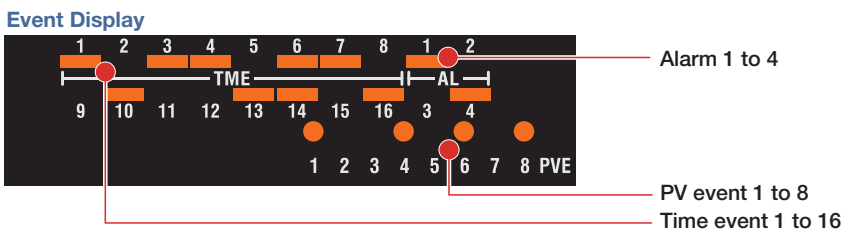
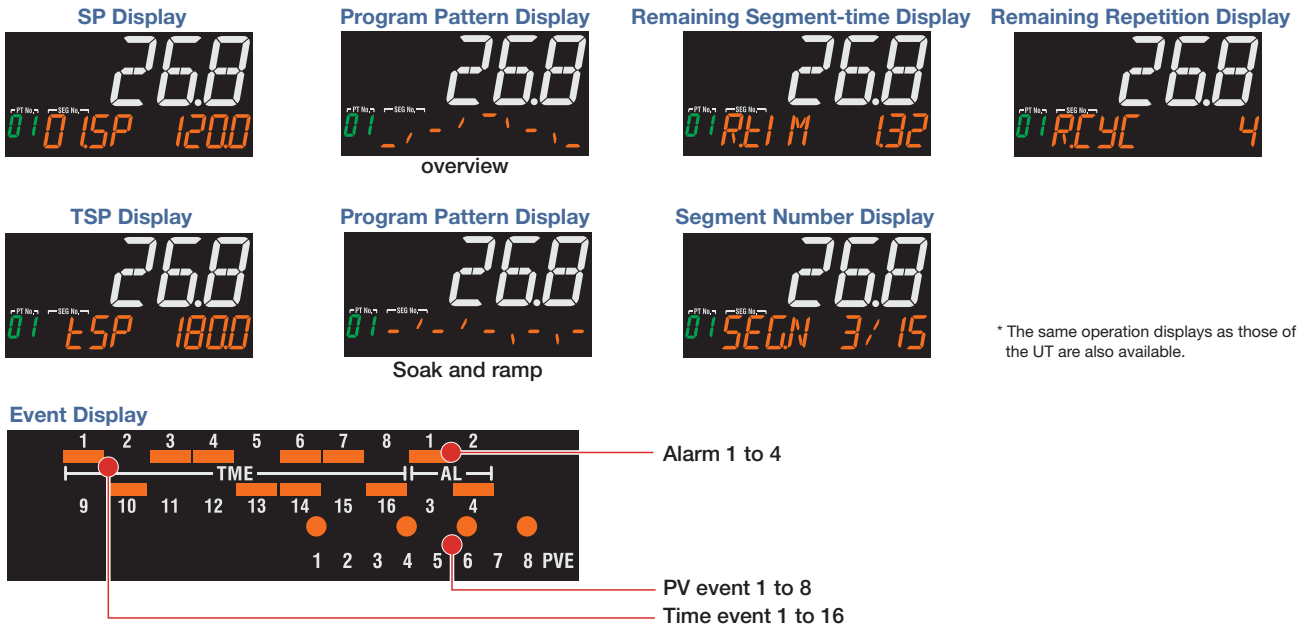

## Functions of the Program Controller

### Fast-forwarding of program operation

Use this function when checking the program pattern setting. Only times of segments and time events can be faster.

### Program pattern-2 retransmission

The controller can serve as a program pattern generator.

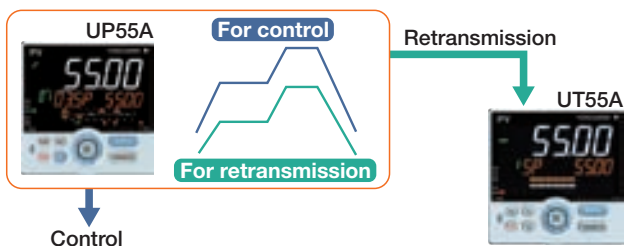

### Synchronized program operation

If the progress of the operation of one unit is faster, the program operation can be forcibly stopped by digital input when switching between segments. Thus, synchronized program operation can be performed.

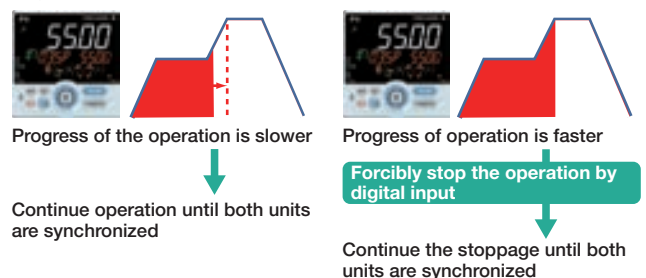







# Networking

## Communication Functions

A network function is built into the back panel of the controller to make wiring simple.



Ethernet

RS-485

Modbus (RTU/ASCII), Peer to Peer, Coordinated, PC-Link

Open Network

(PROFIBUS-DP, CC-Link, DeviceNet)



## Modbus/TCP

Modbus TCP/IP, a protocol that allows the controller to connect to any Ethernet network and have the ability to exchange data with the computers or devices on that network.

- Allows control devices to be integrated into an application simply.
- Works with any Modbus TCP/IP compliant software.
- Support for Modbus function codes 03, 06, 08 & 16.
- Gateway function allows RS-485 Modbus devices to communicate via Ethernet.
- Reduced labor costs in wiring and setup of a communications network.
- Physical layer : 10 BASE-T/100 BASE-TX
- Max. number of connection : 2

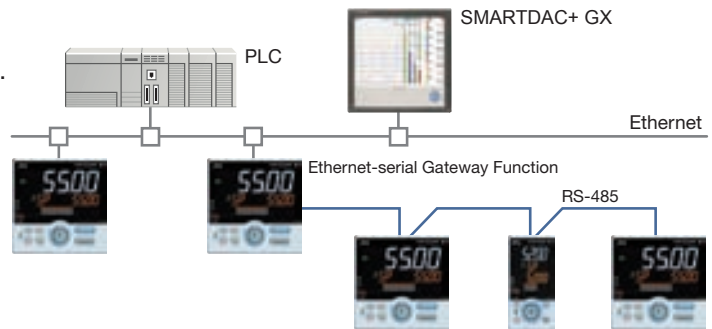

## Modbus/RTU

The data of UTAdvanced (slave units) can be displayed and saved on the DXAdvanced using the Modbus RTU function.

Modbus master

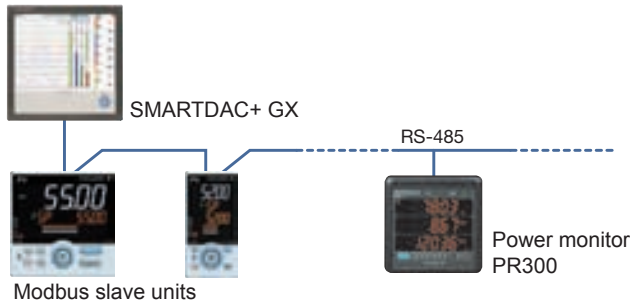

## Peer to Peer

The use of the ladder sequence program makes it possible to exchange analog data and status data between communication-capable UTs.

Example: A UT in which an input error occurs sends a signal to another UT to enable that UT switch to MAN operation, thus shifting the whole system into a safe mode. In such a case, the safety mechanism can be built into the UT Advanced and is not required in the host system.

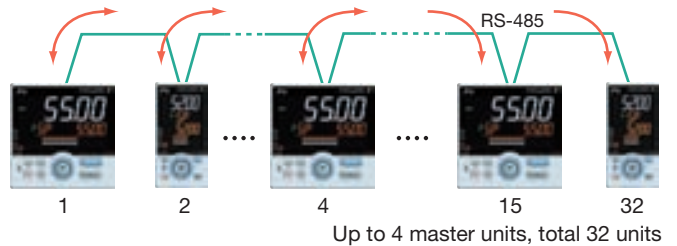

## Coordinated Operation

In coordinated operation, a single UTAdvanced controller is used as a master controller and multiple UTAdvanced or other UT digital indicating controllers as slave controllers.

The slave controllers are operated in accordance with the actions of the master controller.

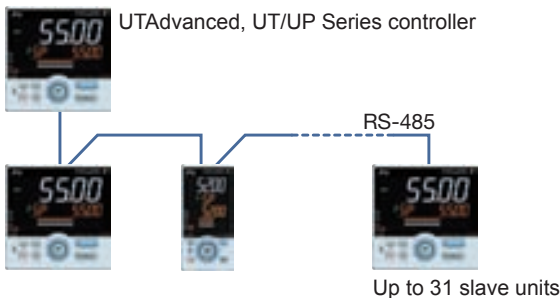

## Open Network (PROFIBUS-DP, CC-Link, DeviceNet)

Embedded open networks will provide direct connection to PLC's.

- Reads data from UTAdvanced
- Writes parameter setting value to UTAdvanced

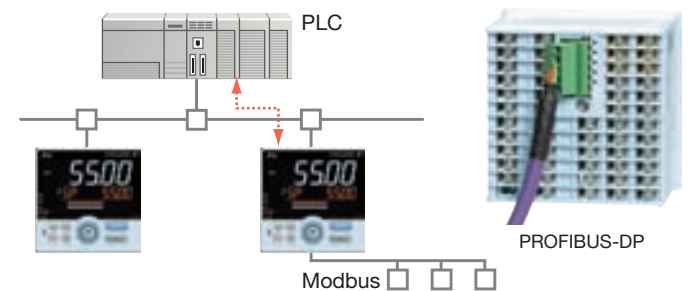

## PC-Link

A protocol used for communicating with a general-purpose personal computer, or UT link module and serial communication module of FA-M3 (range-free controller).

- FA-M3, Daqstation and DXAdvanced are registered trademark of Yokogawa Electric Corporation.
- Ethernet is a registered trademark of Xerox Corporation.
- Modbus is a registered trademark of AEG Schneider Automation Inc.
- PROFIBUS-DP is a registered trademark of PROFIBUS User Organization.
- CC-Link is a registered trademark of CC-Link Partner Association (CLPA).
- DeviceNet is a registered trademark of Open DeviceNet Vender Association, Inc.



# Product line-up

## Digital Indicating Controller UT55A / UT52A / UT35A / UT32A



Model		UT55A	UT52A	UT35A	UT32A	
Size	1/4 DIN	✓	—	✓	—	
	1/8 DIN	—	✓	—	✓	
	Depth from the panel surface (mm)	65	65	65	65	
Control Scan Period	(msec)	Choice 50/100/200	Choice 50/100/200	200	200	
Display Function	Number of PV Display Digits	5	5	5	5	
	Active Color PV Display Function	✓	✓	✓	✓	
	Guide Scroll Display Function	✓	✓	✓	✓	
	Message Display Function	✓	✓	✓	✓	
	Bar graph display (Number)	✓ (2)	✓ (2)	✓ (1)	✓ (1)	
PV Input Indication Accuracy	(% of F.S.)	0.1	0.1	0.1	0.1	
PV Input Type	TC	✓	✓	✓	✓	
	RTD (3-wire)	✓	✓	✓	✓	
	RTD (4-wire)	✓	✓	—	—	
	mV, V	✓	✓	✓	✓	
	mA	✓	✓	✓	✓	
Number of Analog Inputs	Standard (Maximum)	1 (4)	1 (2)	1	1	
Number of SPs (PIDs)	Maximum	8	8	4	4	
Number of Control Modes	Maximum	8	8	1	1	
Number of Control Types	Maximum	8	8	5	5	
Control Output	Type	Relay Contact Output, Voltage pulse output, Current output	✓	✓	✓	✓
	Algorithm	ON/OFF	✓	✓	✓	✓
		PID (Continuance, Time Proportion)	✓	✓	✓	✓
		Position proportional	✓	✓	✓	✓
		Heating / cooling	✓	✓	✓	✓
Number of Analog Outputs	Standard (Maximum)	2 (3)	2 (3)	2	2	
Number of Digital Inputs	Standard (Maximum)	3 (9)	3 (5)	2 (7)	2 (4)	
Number of Alarms		8	8	4	4	
Number of Digital Outputs	Standard (Maximum)	3 (18)	3 (5)	3 (8)	3 (5)	
Communication	RS-485 communication (Maximum)	✓ (2)	✓ (1)	✓ (1)	✓ (1)	
	Ethernet communication	✓	—	✓	—	
	Open Network (CC-Link/PROFIBUS-DP /DeviceNet)	✓	—	✓	—	
	Quick Setting Function	✓	✓	✓	✓	
Various Function	Split Computation Output Function	✓	✓	—	—	
	Ratio and Square Root Extraction Function	✓	✓	—	—	
	Remote SP Function	✓	✓	—	—	
	24 V DC Loop Power Supply Function	✓	✓	✓	✓	
	Heater Break Alarm Function	✓ (Standard type)	✓ (Standard type)	✓ (Standard type or Heating/cooling type)	✓ (Standard type or Heating/cooling type)	
Ladder Sequence Function	(Number of max. steps)	✓ (500)	✓ (500)	✓ (300)	✓ (300)	
Other Specifications	Power Supply	AC100 V to 240 V	✓	✓	✓	✓
		AC/DC 24 V	✓	✓	✓	✓
	Configuration Tool	Dust and waterproof Level of Front Panel	NEMA4*1 (IP56)	NEMA4*1 (IP56)	NEMA4*1 (IP56)	NEMA4*1 (IP56)
		Via Light-loader Communication	✓	✓	✓	✓
		Via Maintenance Port Communication	✓	✓	✓	✓
Via RS-485/Ethernet communication	✓ / ✓	✓ / —	✓ / ✓	✓ / —		

The table above includes specifications of the standard models only.

\* 1: Hose down test only.

### Input Range

Input type	
TC	K, J, T, B, S, R, N, E, L, U, W PL-2, PR20-40, W97Re3-W75Re25
RTD	JPt100, Pt100
DC Voltage	0.4 to 2.0 V, 1.0 to 5.0 V, 0.0 to 2.0 V, 0 to 10 V, -10 to 20 mV, 0 to 100 mV
DC Current	4 to 20 mA, 0 to 20 mA

## Program Controller UP55A / UP35A, Digital Indicator with Alarms UM33A



Model		UP55A	UP35A	UM33A	
<b>Size</b>	1/4 DIN	✓	✓	—	
	1/8 DIN	—	—	✓	
	Depth from the panel surface (mm)	65	65	65	
<b>Control Scan Period</b>	(msec)	Choice 100/200	200	Choice 50/100/200	
<b>Display Function</b>	Number of PV Display Digits	5	5	5	
	Active Color PV Display Function	✓	✓	✓	
	Guide Scroll Display Function	✓	✓	✓	
	Message Display Function	✓	✓	✓	
	Bar graph display (Number)	✓ (2)	✓ (1)	—	
<b>PV Input Indication Accuracy</b>	(% of F.S.)	0.1	0.1	0.1	
<b>PV Input Type</b>	TC	✓	✓	✓	
	RTD (3-wire)	✓	✓	✓	
	RTD (4-wire)	✓	—	—	
	mV, V	✓	✓	✓	
	mA	✓	✓	✓	
<b>Number of Analog Inputs</b>	Standard (Maximum)	1 (4)	1	1	
<b>Number of SPs (PIDs)</b>	Fixed	8	4	—	
<b>Number of Control Modes</b>	Maximum	5	1	—	
<b>Number of Control Types</b>	Maximum	4	4	—	
<b>Control Output</b>	Type	Relay Contact Output, Voltage pulse output, Current output	✓	—	
	Algorithm	ON/OFF	✓	✓	—
		PID (Continuance, Time Proportion)	✓	✓	—
		Position proportional	✓	✓	—
		Heating / cooling	✓	✓	—
<b>Number of Analog Outputs</b>	Standard (Maximum)	2 (3)	2	1	
<b>Number of Digital Inputs</b>	Standard (Maximum)	8 (9)	3 (8)	2	
<b>Number of Program Patterns</b>	Standard (Maximum)	30	2 (4)	—	
<b>Number of Programs</b>	Standard (Maximum)	300	20 (40)	—	
<b>Number of Segments per Pattern</b>		99	20 (40)	—	
<b>Number of PV Events</b>	(Per segment)	8	2	—	
<b>Number of Time Events</b>	(Per segment)	16	4	—	
<b>Number of Alarms</b>	Maximum	8	2	8	
<b>Number of Digital Outputs</b>	Standard (Maximum)	8 (18)	3 (8)	3 (9)	
<b>Communication</b>	RS-485 communication (Maximum)	✓ (2)	✓ (1)	✓ (1)	
	Ethernet communication	✓	✓	—	
	Open Network (CC-Link/PROFIBUS-DP /DeviceNet)	✓	✓	—	
<b>Various Function</b>	Quick Setting Function	✓	✓	✓	
	Split Computation Output Function	✓	—	✓	
	Ratio and Square Root Extraction Function	✓	—	✓ *2	
	Remote SP Function	✓	—	✓	
	24 V DC Loop Power Supply Function	—	—	✓	
	Heater Break Alarm Function	✓ (Standard type)	✓ (Standard type)	—	
<b>Ladder Sequence Function</b>	(Number of max. steps)	✓ (500)	✓ (300)	—	
<b>Other Specifications</b>	Power Supply	AC100 V to 240 V	✓	✓	
		AC/DC 24 V	✓	✓	
	Dust and waterproof Level of Front Panel		NEMA4*1 (IP56)	NEMA4*1 (IP56)	NEMA4*1 (IP56)
		Configuration Tool	Via Light-loader Communication	✓	✓
			Via Maintenance Port Communication	✓	✓
			Via RS-485/Ethernet communication	✓ / ✓	✓ / ✓

The table above includes specifications of the standard models only.

\* 1: Hose down test only.

\* 2: Square root extraction available



# Product line-up

## Digital Indicating Controller UT55A / UT52A (Standard model)



### Main Features

- Up to 4 analog inputs available
- 3 alarm independent common terminals available as standard
- Ladder sequence programs can be built
- Simple operation
- Up to 18 DOs (combinations available)
- Multiple language operation manual (Japanese, English, German, French, Spanish, Chinese, and Korean) available. Please specify the desired language when ordering.

### External Dimensions

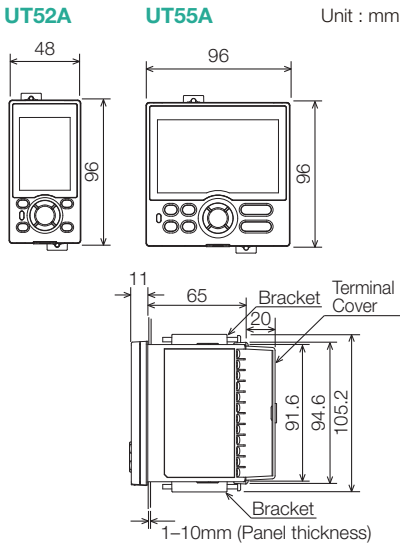

### Model and Suffix Codes

Model	Suffix code	Optional suffix code	Description
<b>UT55A</b>			Digital Indicating Controller (provided with retransmission output or 15 V DC loop power supply, 3 DIs, and 3 DOs) (Power supply: 100-240 V AC)
Basic control	-0		Standard type
	-1		Position proportional type
	-2		Heating / cooling type
Functions (* 1)	0		None
	1		Remote (1 additional aux. analog input, 6 additional DIs, 5 additional DOs, and RS-485 communication (Max.19.2 kbps, 2-wire / 4-wire) (* 2)
	2		Remote (1 additional aux. analog input, 1 additional DI, and RS-485 communication (Max.19.2 kbps, 2-wire / 4-wire) (* 2)
	3		5 additional DIs and 5 additional DOs
	4		Remote (1 additional aux. analog input and 1 additional DI)
	5		Remote (1 additional aux. analog input, 6 additional DIs, and 5 additional DOs)
	6		5 additional DIs and 15 additional DOs
Open networks	0		None
	1		RS-485 communication (Max.38.4 kbps, 2-wire / 4-wire)
	2		Ethernet communication (with serial gateway function)
	3		CC-Link communication (with Modbus master function)
	4		PROFIBUS-DP communication (with Modbus master function)
Display language (* 7)			DeviceNet communication (with Modbus master function)
		-1	English
		-2	German
		-3	French
Case color		-4	Spanish
		0	White (Light gray)
Options		1	Black (Light charcoal gray)
		-00	Always "-00"
Options		/DR	Additional direct input (TC and 3-wire / 4-wire RTD) and DC current to Remote (1 additional aux. analog input, 1 DI to be deleted (* 3))
		/LP	24 V DC loop power supply (* 4)
		/HA	Heater break alarm (* 5)
		/DC	Power supply 24 V AC / DC
		/CT	Coating (* 6)

- \* 1: When "1" or "6" is specified for the Functions code, only "0" can be specified for the Open networks code.  
 \* 2: When the /LP option is specified, the RS-485 communication is 2-wire system.  
 \* 3: When any of "1," "2," "4," "5," or "7" is specified for the Functions code, the /DR option can be specified.  
 \* 4: /LP option can be specified in the combination of Functions code (any of "0," "2," "3" or "4") and Open networks code (any of "0" or "1"). Additionally, /LP option can be specified in the combination of Functions code "1" and Open networks code "0".  
 \* 5: When "-0" is specified for the Basic control code, the /HA option can be specified.  
 \* 6: When the /CT option is specified, the UT55A does not conform to the safety standards (UL and CSA) and CE marking.  
 \* 7: English, German, French, and Spanish can be displayed as the guide display.

Model	Suffix code	Optional suffix code	Description
<b>UT52A</b>			Digital Indicating Controller (provided with retransmission output or 15 V DC loop power supply, 3 DIs, and 3 DOs) (Power supply: 100-240 V AC)
Basic control	-0		Standard type
	-1		Position proportional type
	-2		Heating / cooling type
Functions	0		None
	1		Remote (1 additional aux. analog input, 1 additional DI, and RS-485 communication (Max. 38.4 kbps, 2-wire))
	2		Remote (1 additional aux. analog input and 1 additional DI)
Open networks	0		2 additional DIs and 2 additional DOs
			None
Display language (* 5)		-1	English
		-2	German
		-3	French
		-4	Spanish
Case color		0	White (Light gray)
		1	Black (Light charcoal gray)
Options		-00	Always "-00"
		/DR	Additional direct input (TC and 3-wire / 4-wire RTD) and DC current to Remote (1 additional aux. analog input, 1 DI to be deleted. (* 1))
	/LP	24 V DC loop power supply (* 2)	
	/HA	Heater break alarm (* 3)	
	/DC	Power supply 24 V AC / DC	
	/CT	Coating (* 4)	

- \* 1: When "2" is specified for the Functions code, the /DR option can be specified.  
 \* 2: When "-0" or "-1" is specified for the Basic control code, the /LP option can be specified.  
 \* 3: When "-0" is specified for the Basic control code, the /HA option can be specified.  
 \* 4: When the /CT option is specified, the UT52A does not conform to the safety standards (UL and CSA) and CE marking.  
 \* 5: English, German, French, and Spanish can be displayed as the guide display.

### Popular Universal I/O and Auto-Tuning Function Available

#### Universal Input

Select from TC, RTD, mV / DC voltage and DC current.  
 (Direct connection : No shunt resistor required)

The input type and range is user selectable via the front panel or by using the LL50A parameter setting software.

- 0.1% Indication Accuracy
- Connect up to two 2-wire transmitters simultaneously

All instruments have a 15 V Loop Power Supply (15 V LPS) for a transmitter.

In addition, a 24 V LPS is also available simultaneously for some instruments as optional function.

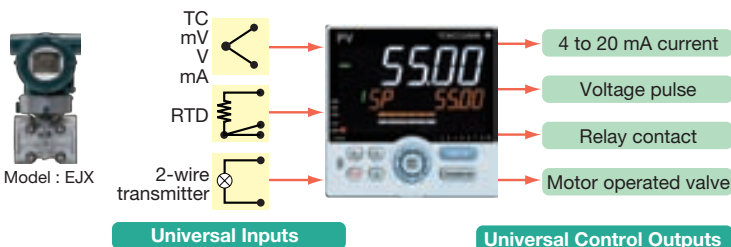

<b>Thermocouple Type</b>	K, J, T, B, S, R, N, E, L, U, W, PL-2, PR20-40, W97Re3-W75Re25
<b>RTD Type</b>	Pt100, JPt100
<b>DC Voltage Input</b>	0.4 to 2V, 1 to 5V, 0 to 2V, 0 to 10V, -10 to 20mV, 0 to 100mV
<b>DC Current Input</b>	4 to 20mA, 0 to 20mA

#### Position proportional control for Control motor

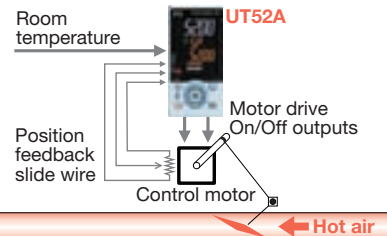

# Digital Indicating Controller UT35A / UT32A (Standard model)



## Main Features

- 4 target setpoints (PID numbers) available as standard
- 3 alarm independent common terminals available as standard
- Ladder sequence programs can be built
- Simple operation
- Up to 8 DOs (combinations available)
- Multiple language operation manual (Japanese, English, German, French, Spanish, Chinese, and Korean) available. Please specify the desired language when ordering.

## External Dimensions

UT32A      UT35A      Unit : mm

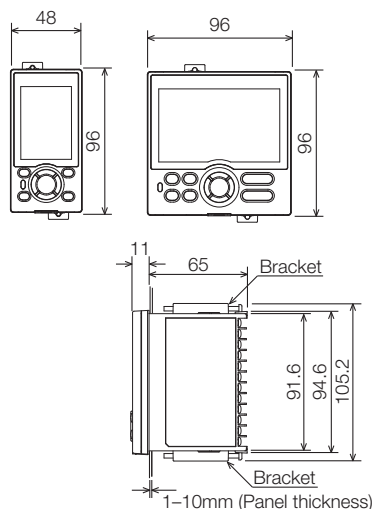

## Model and Suffix Codes

Model	Suffix code	Optional suffix code	Description
UT35A			Digital Indicating Controller (provided with retransmission output or 15 V DC loop power supply, 2 DIs, and 3 DOs) (Power supply: 100-240 V AC)
Basic control	-0		Standard type
	-1		Position proportional type
	-2		Heating / cooling type
Functions	0		None
	1		2 additional DIs and 2 additional DOs
	2		5 additional DIs and 5 additional DOs
Open networks	0		None
	1		RS-485 communication (Max.38.4 kbps, 2-wire / 4-wire)
	2		Ethernet communication (with serial gateway function)
	3		CC-Link communication (with Modbus master function)
	4		PROFIBUS-DP communication (with Modbus master function)
	5		DeviceNet communication (with Modbus master function)
Display language (*1)	-1		English
	-2		German
	-3		French
	-4		Spanish
Case color	0		White (Light gray)
	1		Black (Light charcoal gray)
		-00	Always "-00"
Options		/LP	24 V DC loop power supply (* 2)
		/HA	Heater break alarm (* 3)
		/DC	Power supply 24 V AC / DC
		/CT	Coating (* 4)

\* 1: English, German, French, and Spanish can be displayed as the guide display.  
 \* 2: The /LP option can be specified in combination with function code "0" or "1" and open network code "0" or "1."  
 \* 3: The /HA option can be specified when basic control code is "-0" or "-2."  
 \* 4: When the /CT option is specified, the UT35A does not conform to the safety standards (UL and CSA) and CE marking.

Model	Suffix code	Optional suffix code	Description
UT32A			Digital Indicating Controller (provided with retransmission output or 15 V DC loop power supply, 2 DIs, and 3 DOs) (Power supply: 100-240 V AC)
Basic control	-0		Standard type
	-1		Position proportional type
	-2		Heating / cooling type
Functions	0		None
	1		RS-485 communication (Max.38.4 kbps, 2-wire / 4-wire) (* 2)
	2		2 additional DIs and 2 additional DOs
Open networks	0		None
Display language (*1)	-1		English
	-2		German
	-3		French
	-4		Spanish
Case color	0		White (Light gray)
	1		Black (Light charcoal gray)
		-00	Always "-00"
Options		/LP	24 V DC loop power supply (* 2)
		/HA	Heater break alarm (* 3)
		/DC	Power supply 24 V AC / DC
		/CT	Coating (* 4)

\* 1: English, German, French, and Spanish can be displayed as the guide display.  
 \* 2: The /LP option can be specified in combination with basic control code "-0" or "-1" and function code "0" or "1." Furthermore, when the function code is "1," the RS-485 communication is 2-wire system.  
 \* 3: The /HA option can be specified when basic control code is "-0" or "-2."  
 \* 4: When the /CT option is specified, the UT32A does not conform to the safety standards (UL and CSA) and CE marking.

## Sold separately (Accessory)

Model Name	Model	Note
Terminal Cover	UTAP001	For UT55A/UT35A/UP55A/UP35A
	UTAP002	For UT52A/UT32A/UM33A
User's Manual (CD-ROM)	UTAP003	Contains all manuals.

## Universal Output

User selectable for Relay, Voltage Pulse and Current outputs.

- Relay output: ON/OFF control, Time-proportional PID control
- Voltage Pulse output: Time-proportional PID control
- Current output: Continuous PID control

Heating/Cooling Control has two sets of universal outputs.

- Any combinations of Relay, Pulse and Current outputs are available.

Drive a Motorized Control Valve by using Position-Proportional PID.

- The position-proportional PID control function has two sets of relay outputs for direct / reverse rotation of motorized control valve.
- The slide wire input to feed back the valve position is also available.

## Auto-Tuning (AT) Function

The following conditions can be set in order to increase the accuracy of calculating PID constants using AT .

- 1) Two types of algorithms to calculate PID constants are available for selection.  
 Normal: Fast-rising PID constant  
 Stable: Slow-rising PID constant
- 2) High and low output limits can be set individually for control output values during AT runtime.



# Product line-up

## Program Controller UP55A (Standard model)



### Main Features

- Up to 30 program patterns
- 8 PV events, 16 time events, and 8 alarms can be monitored simultaneously
- Ladder sequence programs can be built
- Simple operation
- Up to 9 DIs and 18 DOs (combinations available)
- Multiple language operation manual (Japanese, English, German, French, Spanish, Chinese, and Korean) available. Please specify the desired language when ordering.

### External Dimensions

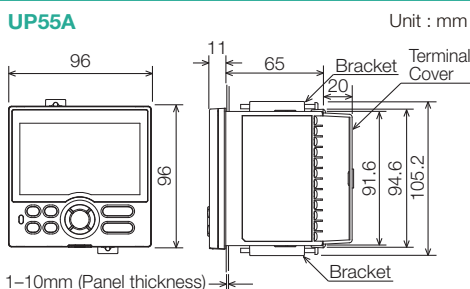

### Model and Suffix Codes

Model	Suffix code	Optional suffix code	Description
UP55A			Program Controller (provided with retransmission output or 15 V DC loop power supply, 8 DIs, and 8 DOs) (Power supply: 100-240 V AC) 30 program patterns / 300 program segments (Max. 99 segments per pattern)
Basic control	-0		Standard type
	-1		Position proportional type
	-2		Heating/cooling type
Functions (*1)	0		None
	1		Remote (1 additional aux. analog) input, 1 additional DI
	2		RS-485 communication (Max.19.2 kbps, 2-wire/4-wire)
	3		10 additional DOs
	4		3 additional aux. analog inputs, 2 DIs and 5 DOs to be deleted
Open networks	0		None
	1		RS-485 communication (Max.38.4 kbps, 2-wire/4-wire)
	2		Ethernet communication (with serial gateway function)
	3		CC-Link communication (with Modbus master function)
	4		PROFIBUS-DP communication (with Modbus master function)
Display language (*2)	-1		English
	-2		German
	-3		French
	-4		Spanish
	0		White (Light gray)
1		Black (Light charcoal gray)	
Fixed code		-00	Always "-00"
Optional suffix codes		/DR	Additional direct input (TC and 3-wire/4-wire RTD) and current input to Remote (1 additional aux. analog) input, 1 DI to be deleted (*3)
		/HA	Heater break alarm (*4)
		/DC	Power supply 24 V AC/DC
		/CT	Coating (*5)

\* 1: When "3" is specified for the Function code, only "0" can be specified for the Open network code.

\* 2: English, German, French, and Spanish can be displayed as the guide display.

\* 3: When any of "1" or "4" is specified for the Function code, the /DR option can be specified.

\* 4: When "-0" is specified for the Basic control code, the /HA option can be specified.

\* 5: When the /CT option is specified, the UP55A does not conform to the safety standards (UL and CSA) and CE marking.

## Program Controller UP35A (Standard model)



### Main Features

- Up to 4 program patterns
- 2 PV events, 4 time events, and 2 alarms can be monitored simultaneously.
- Ladder sequence programs can be built
- Simple operation
- Up to 8 DIs and 8 DOs (combinations available)
- Multiple language operation manual (Japanese, English, German, French, Spanish, Chinese, and Korean) available. Please specify the desired language when ordering.

### External Dimensions

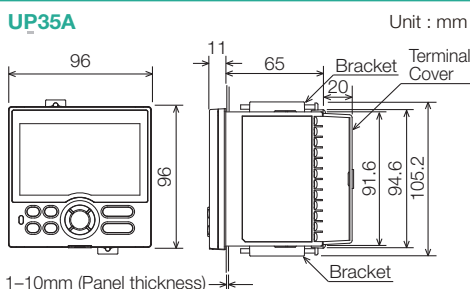

### Model and Suffix Codes

Model	Suffix code	Optional suffix code	Description
UP35A			Program Controller (provided with retransmission output or 15 V DC loop power supply, 3 DIs, and 3 DOs) (Power supply: 100-240 V AC) 2 program patterns/20 program segments (Max. 20 segments per pattern)
Basic control	-0		Standard type
	-1		Position proportional type
	-2		Heating/cooling type
Functions	0		None
	1		5 additional DIs, 5 additional DOs
Open networks	0		None
	1		RS-485 communication (Max.38.4 kbps, 2-wire/4-wire)
	2		Ethernet communication (with serial gateway function)
	3		CC-Link communication (with Modbus master function)
	4		PROFIBUS-DP communication (with Modbus master function)
Display language (*1)	-1		English
	-2		German
	-3		French
	-4		Spanish
	0		White (Light gray)
1		Black (Light charcoal gray)	
Fixed code		-00	Always "-00"
Optional suffix codes		/AP	2 additional patterns/20 additional segments
		/HA	Heater break alarm (*2)
		/DC	Power supply 24 V AC/DC
		/CT	Coating (*3)

\* 1: English, German, French, and Spanish can be displayed as the guide display.

\* 2: The /HA option can be specified when the Basic control code is "-0" or "-2."

\* 3: When the /CT option is specified, the UP35A does not conform to the safety standards (UL and CSA) and CE marking.

# Digital Indicator with Alarms UM33A (Standard model)



## Main Features

- Up to 9 alarm outputs (including one Fail)
- Input correction function (PV bias, polygonal line approximation, polygonal line bias)
- 24 VDC sensor power supply available
- Simple operation
- Multiple language operation manual (Japanese, English, German, French, Spanish, Chinese, and Korean) available. Please specify the desired language when ordering.

## External Dimensions

UM33A

Unit : mm

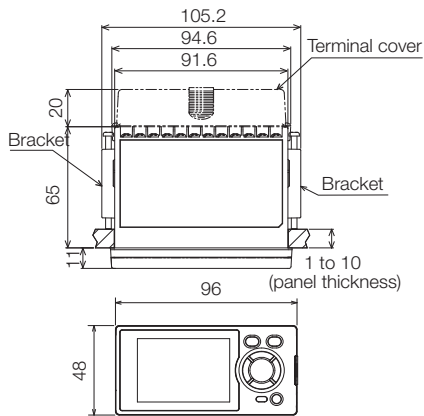

## Model and Suffix Codes

Model	Suffix code	Optional suffix code	Description
UM33A			Digital Indicator with Alarms (provided with retransmission output or 15 V DC loop power supply, 2 DIs, and 3 DOs) (Power supply: 100-240 V AC)
Basic control	-0		Standard type
Functions	0		None
	1		1 additional DO (c-contact relay), RS-485 communication (Max. 38.4 kbps, 2-wire/4-wire)
	2		1 additional DO (c-contact relay)
	3		6 additional DOs (c-contact relay; 1 point and open collector; 5 points)
Open networks	0		None
Display language (*1)	-1		English
	-2		German
	-3		French
	-4		Spanish
Case color	0		White (Light gray)
	1		Black (Light charcoal gray)
Optional suffix codes	/LP		24 V DC loop power supply (*2)
	/DC		Power supply 24 V AC/DC
	/CT		Coating (*3)

\* 1: English, German, French, and Spanish can be displayed as the guide display.

\* 2: The /LP option can be specified only when the code for Function is "0", "1" or "2". Additionally, the RS-485 communication for "1" of the Function code is 2-wire system.

\* 3: When the /CT option is specified, the UM33A does not conform to the safety standards (UL and CSA) and CE marking.

## Other Convenient Functions Available

### Parameter Setting

LL50A Parameter Setting Software (sold separately) allows for easily setting parameters.

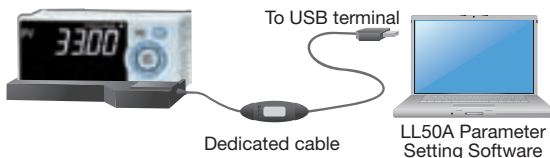

### Quick Setting Function

Minimum parameters necessary for operation can be set.

### Security Function

The password function can prevent inadvertent changes to the parameter settings. If a password is set, the password is required when moving to the Setup Parameter Setting Display. When the password is verified, can be changed to the Setup Parameter Setting Display.

### Message Function

Using the message function and turning the contact input on/off, the message registered beforehand can be displayed on PV display by interrupt.

The message is registered using LL50A Parameter Setting Software. The messages are limited to 20 alphanumeric characters. A maximum of four messages can be registered.



Operation Display



CLOSE VALVE

When the contact input is turned on, the scrolling message registered beforehand is displayed on PV Display.



# Configuration Tool

## LL50A Parameters Setting Software

### Parameter Setting/Program Pattern Creating Function

Parameters that determine controller functions can easily be set: controller model type, controller mode (single-loop control, cascade control, loop control with PV switching, etc.), universal input/output functions, setup parameters and others. It also allows you to create program patterns.

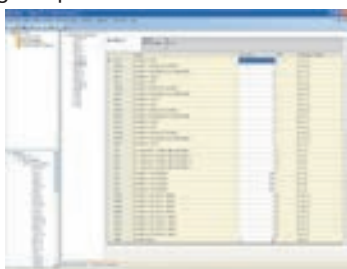

Parameters setting display

### Tuning Function

Used to tune a controller's PID parameters. Displays measured input value, target setpoint, and control output value as a trend graph on a personal computer screen, allowing PID parameter modification, AUTO/MAN switching, control output modification in manual operation, etc.

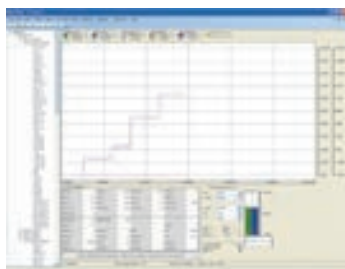

Tuning display

### Ladder Building Functions

Ladder sequence programs can be created and ladder programs can be monitored.

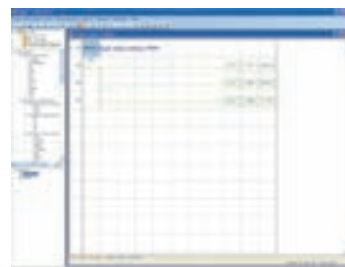

Ladder programs building display

### Network Profile Creating Function

Can be used to create an electronic device data sheet for Open Network.

### Via Bus Powered USB Cable

Can be set parameters while no power supply to controller.



### Via Ethernet Communication Connector

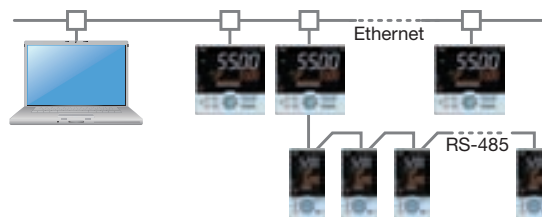

### Via Dedicated Adapter

Can be used while attached to the control panel.

- Applicable Controllers : UT75A, UT55A  
UT52A, UT35A  
UT32A, UP55A  
UP35A, UM33A
- Applicable OS : Windows XP / Vista  
Windows 7 Professional (32-bit and 64-bit versions)  
Windows 8 Pro (32-bit and 64-bit versions) (Desktop type)
- Communication method : USB 1.1



### Via RS-485 Communication Terminals



### Model and Suffix Code

Model	Suffix code	Description
LL50A	-00	Parameters Setting Software

UTAdvanced is a registered trademark of Yokogawa Electric Corporation. Microsoft, MS, and Windows are registered trademarks or trademarks of Microsoft Corporation in the United States and other countries. Other company names and product names appearing in this document are registered trademarks or trademarks of their respective holders.

A parameter conversion tool that enables GREEN series parameter data to be used with the LL50A is available and downloadable from the website below. <https://y-link.yokogawa.com>

**vigilantplant.**<sup>®</sup>

SEE  
CLEARLY

KNOW  
IN ADVANCE

ACT  
WITH AGILITY

The clear path to operational excellence

VigilantPlant is Yokogawa's automation concept for safe, reliable, and profitable plant operations. VigilantPlant aims to enable an ongoing state of Operational Excellence where plant personnel are watchful and attentive, well-informed, and ready to take actions that optimize plant and business performance.

#### YOKOGAWA ELECTRIC CORPORATION

Control Instruments Business Division/Phone: (81)-422-52-7179, Fax: (81)-422-52-6973  
E-mail: ns@cs.jp.yokogawa.com

#### YOKOGAWA CORPORATION OF AMERICA

YOKOGAWA EUROPE B.V.

YOKOGAWA ENGINEERING ASIA PTE. LTD.

Phone: 800-258-2552, Fax: (1)-770-254-0928

Phone: (31)-88-4641000, Fax: (31)-88-4641111

Phone: (65)-62419933, Fax: (65)-62412606

Sign up for our free e-mail newsletter  
[www.yokogawa.com/ns/](http://www.yokogawa.com/ns/)

Vig-RS-6E

Printed in Japan, 401(KP) [Ed : 06/b]

Subject to change without notice.  
All Rights Reserved, Copyright © 2009, Yokogawa Electric Corporation.

**YOKOGAWA**