

**Mitsubishi General-Purpose Programmable Controller**  
**Renewal Tool Base Adapter**  
 Model  
**ERNT-AQB38/-AQB35/-AQB32**  
**ERNT-AQB68/-AQB65/-AQB62**  
**ERNT-AQB58/-AQB55/-AQB52**  
**User's Manual**



*ERNT-AQB38/-AQB35/-AQB32*  
*ERNT-AQB68/-AQB65/-AQB62*  
*ERNT-AQB58/-AQB55/-AQB52*

Model	ERNT-AQB38/-AQB35/-AQB32 ERNT-AQB68/-AQB65/-AQB62 ERNT-AQB58/-AQB55/-AQB52
50EM8557-D(1401)MEE	

**MITSUBISHI ELECTRIC ENGINEERING COMPANY LIMITED**  
 HEAD OFFICE: 6-6-6 KUDAN BLDG 1-13-6, KUDANKITA CHYODA-KU, TOKYO 102-0073, JAPAN  
 NAGOYA ENGINEERING OFFICE: 1-139 SHIMOYASHIKUCHO-SHIMOHASHIKI, KASUGAI, AICHI 486-0906, JAPAN

**SAFETY PRECAUTIONS**

(Always read these precautions prior to use.)

Before using this product, please read this manual carefully and pay full attention to safety to ensure that the product is used correctly.

The precautions presented in this manual are concerned with this product only. For Programmable Controller system safety precautions, refer to the user's manual of the MELSEC-Q series CPU module to be used.

In this manual, the safety precautions are ranked as "DANGER" and "CAUTION."

**DANGER** Indicates that incorrect handling may cause hazardous conditions, resulting in death or severe injury.

**CAUTION** Indicates that incorrect handling may cause hazardous conditions, resulting in medium or minor injury and/or property damage.

Note that failure to observe the CAUTION level instructions may lead to a serious consequence according to the circumstances. Always follow the precautions of both levels because they are important to personal safety.

Please keep this manual in an easy-to-access location for future reference, and be sure to provide the manual to the end user.

**Installation Precautions**

**CAUTION**

- Use the base adapter in an environment of the general specifications defined in the MELSEC-Q series CPU module user's manual. Failure to do so could lead to electric shock, fire, malfunction or product failure or deterioration.
- Fully secure the base adapter, Q base unit and conversion adapter anchor base using the installation screws, and tighten the installation screws securely within the specified torque range. Failure to do so could cause the product to fall, resulting in damage.

**DANGER**

- Be sure to shut off all phases of the external power supply before performing installation work. Failure to do so could result in electric shock or product damage.

**Startup and Maintenance Precautions**

**DANGER**

- Be sure to shut off all phases of the external power supply before cleaning and retightening the installation screws. Failure to do so could lead to electric shock. Excessively tightened screws could result in damage, causing the product to fall, a short circuit or product malfunction.

**Disposal Precautions**

**DANGER**

- When disposing of the product, treat it as industrial waste.

**1. Overview**

This manual describes the Mitsubishi general-purpose Programmable Controller renewal tool base adapter (ERNT-AQB38, ERNT-AQB35, ERNT-AQB32, ERNT-AQB68, ERNT-AQB65, ERNT-AQB62, ERNT-AQB58, ERNT-AQB55, ERNT-AQB52). The base adapter is a product that enables MELSEC-Q series installation using the MELSEC-A series installation holes. (Additional hole machining not required) Once you have opened the packaging, verify that it contains the following products.

Product	Quantity
Base adapter	1
Q base unit installation screws (M4 x 8)	4

**2. Product Specifications**

Base Adapter Model	Specifications			Weight (g)
	MELSEC-A Series Compatible Module	MELSEC-Q Series Compatible Module	Installable Conversion Adapter Anchor Base	
ERNT-AQB38	A38B A38HB	Q312B Q38B	ERNT-AQF12 ERNT-AQF8	970
ERNT-AQB68	A68B	Q612B Q68B		930
ERNT-AQB58	A58B	Q68B	ERNT-AQF8	870
ERNT-AQB35	A35B	Q38B Q35B	ERNT-AQF8 ERNT-AQF5	795
ERNT-AQB65	A65B	Q68B Q65B Q55B		790
ERNT-AQB55	A55B	Q65B Q55B	ERNT-AQF5	655
ERNT-AQB32	A32B	Q33B	ERNT-AQF3	675
ERNT-AQB62	A62B	Q63B Q52B		650
ERNT-AQB52	A52B	Q52B		505

**3. Mounting and Installation**

**3.1 Handling Precautions**

- Do not drop or apply heavy impact to the base adapter. Doing so could result in damage.
- Fully secure the Q base unit and conversion adapter anchor base using the installation screws, and securely tighten the screws within the specified torque range. Loose screws could cause a short circuit, fire or malfunction.

Screw Location	Tightening Torque Range
Q base unit installation screw (M4 screw)	139 to 189N·cm
Conversion adapter anchor base installation screw (M4 screw)	

**3.2 Installation Environment**

For details of the installation environment, refer to the user's manual of the MELSEC-Q series CPU module to be used.

**4. Installation Dimensions**

- The width dimension is smaller than that of the MELSEC-A series.
- The base adapter installation holes (4 locations) have the same installation dimensions as those of the MELSEC-A series base unit. There is no need for additional screw hole machining on the control panel.

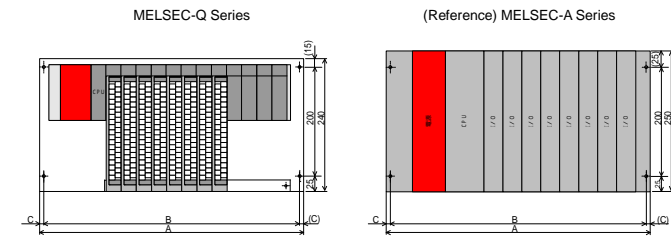

Base Adapter Model	A	B	C	MELSEC-A Series Base Unit Model	A	B	C
ERNT-AQB38	480	460	10	A38B, A38HB	480	460	10
ERNT-AQB68	466	446	10	A68B	466	446	10
ERNT-AQB58	411	391	10	A58B	411	391	10
ERNT-AQB35	382	362	10	A35B	382	362	10
ERNT-AQB65	352	332	10	A65B	352	332	10
ERNT-AQB55	297	277	10	A55B	297	277	10
ERNT-AQB32	247	227	10	A32B	247	227	10
ERNT-AQB62	238	218	10	A62B	238	218	10
ERNT-AQB52	183	163	10	A52B	183	163	10

**5. Q Base Unit and Conversion Adapter Anchor Base Installation Locations**

**5.1 ERNT-AQB38**

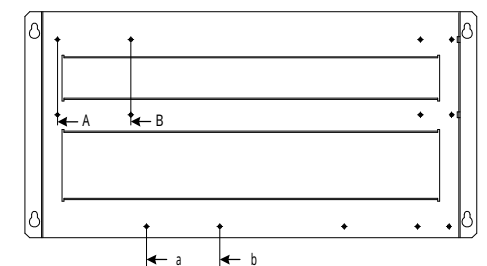

Conversion Adapter Anchor Base	ERNT-AQF12	ERNT-AQF8
Q Base Unit	A	A
Q312B	a	a
Q38B	Combination not possible	B b

Upper half : Q base unit installation location

Lower half : Conversion adapter anchor base screw tightening location

5.2 ERNT-AQB68

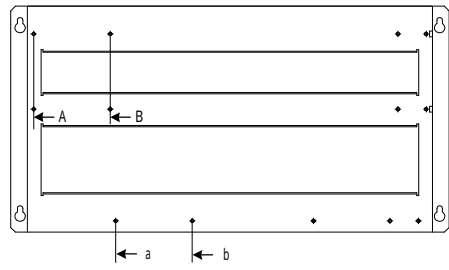

Q Base Unit	Conversion Adapter Anchor Base	ERNT-AQF12	ERNT-AQF8
Q612B		A	A
		a	a
Q68B	Combination not possible	B	b
			b

Upper half : Q base unit installation location  
 Lower half : Conversion adapter anchor base screw tightening location

5.5 ERNT-AQB65

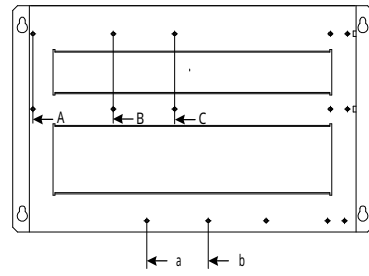

Q Base Unit	Conversion Adapter Anchor Base	ERNT-AQF8	ERNT-AQF5
Q68B		A	A
		a	a
Q65B	Combination not possible	B	b
			b
Q55B	Combination not possible	C	C
			b

Upper half : Q base unit installation location  
 Lower half : Conversion adapter anchor base screw tightening location

5.8 ERNT-AQB62

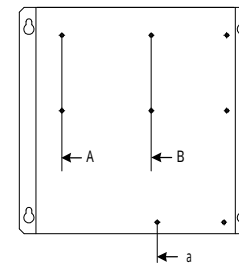

Q Base Unit	Conversion Adapter Anchor Base	ERNT-AQF3
Q63B		A
		a
Q52B		B
		a

Upper half : Q base unit installation location  
 Lower half : Conversion adapter anchor base screw tightening location

5.9 ERNT-AQB52

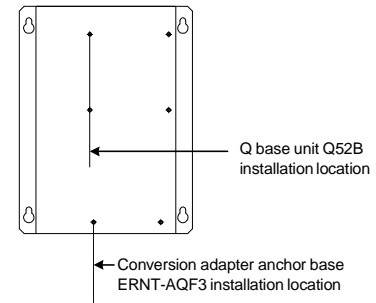

5.3 ERNT-AQB58

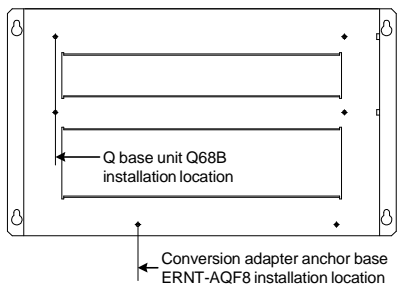

5.4 ERNT-AQB35

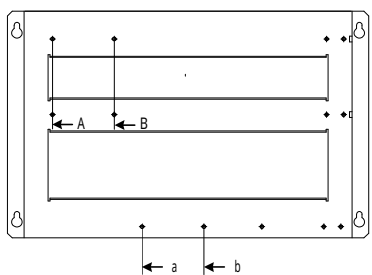

Q Base Unit	Conversion Adapter Anchor Base	ERNT-AQF8	ERNT-AQF5
Q38B		A	A
		a	a
Q35B	Combination not possible	B	b
			b

Upper half : Q base unit installation location  
 Lower half : Conversion adapter anchor base screw tightening location

5.6 ERNT-AQB55

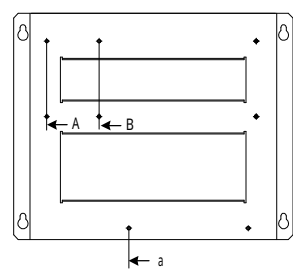

Q Base Unit	Conversion Adapter Anchor Base	ERNT-AQF5
Q65B		A
		a
Q55B		B
		a

Upper half : Q base unit installation location  
 Lower half : Conversion adapter anchor base screw tightening location

5.7 ERNT-AQB32

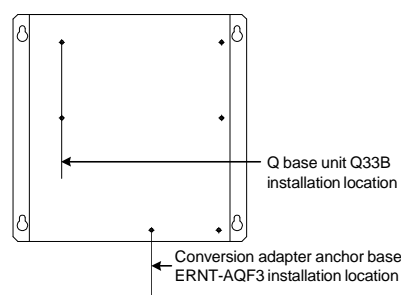

6. External Dimensions

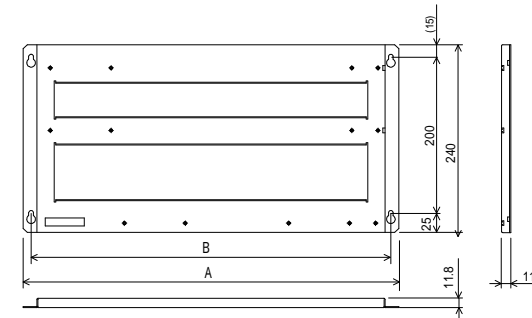

Base Adapter Model	A	B
ERNT-AQB38	480	460
ERNT-AQB68	466	446
ERNT-AQB58	411	391
ERNT-AQB35	382	362
ERNT-AQB65	352	332
ERNT-AQB55	297	277
ERNT-AQB32	247	227
ERNT-AQB62	238	218
ERNT-AQB52	183	163

Product Warranty Details

Please confirm the following product warranty details prior to product use.

Gratis Warranty Terms and Gratis Warranty Range

If any fault or defect (hereinafter referred to as "Failure") attributable to Mitsubishi Electric Engineering Company Limited (hereinafter referred to as "MEE") should occur within the gratis warranty period, MEE shall repair the product free of charge via the distributor from whom you made your purchase.

- Gratis Warranty Period**  
 The gratis warranty period of this product shall be one (1) year from the date of purchase or delivery to the designated place.  
 Note that after manufacture and shipment from MEE, the maximum distribution period shall be six (6) months, and the gratis warranty period after manufacturing shall be limited to eighteen (18) months.  
 In addition, the gratis warranty period for repaired products shall not exceed the gratis warranty period established prior to repair.
- Gratis Warranty Range**  
 The gratis warranty range shall be limited to normal use based on the usage conditions, methods and environment, etc., defined by the terms and precautions, etc., given in the instruction manual, user's manual and caution labels on the product.

Warranty Period after Discontinuation of Production

- MEE shall offer product repair services (fee applied) for seven (7) years after production of the product has been discontinued. Discontinuation of production shall be reported via distributors.
- Product supply (including spare parts) is not possible after production has been discontinued.

Exclusion of Opportunity Loss and Secondary Loss from Warranty Liability

Regardless of the gratis warranty period, MEE shall not be liable for compensation for damages arising from causes not attributable to MEE, opportunity losses or lost profits incurred by the user due to Failures of MEE products, damages or secondary damages arising from special circumstances, whether foreseen or unforeseen by MEE, compensation for accidents, compensation for damages to products other than MEE products, or compensation for other work carried out by the user.

Changes in Product Specifications

The specifications given in the catalogs, manuals and technical documents are subject to change without notice.

This document is a new publication, effective January 2014. Specifications are subject to change without notice. The standard price does not include consumption tax. Please note that consumption tax will be added at the time of purchase. This manual was printed on recycled paper.