



AutoDome Easy

VEZ Series



BOSCH

AutoDome, Bilinx, Bosch, the Bosch logo, DiBos, FastAddress and VIDOS are registered trademarks of Bosch Security Systems, inc.

The following trademarks are registered with the United States Patent and Trademark Office:

Pentium is a registered trademark of Intel Corporation

.NET, DirectX, Internet Explorer, Microsoft, Windows, Windows 2000 and Windows XP are registered trademarks of Microsoft Corporation

Due to the nature of this material, this document refers to numerous hardware and software products by their trade names. In most, if not all cases, these designations are claimed as trademarks or registered trademarks by their respective companies in the United States of America. It is not this publisher's intent to use any of these names generically. The reader is therefore cautioned to investigate all claimed trademark rights before using any of these names other than to refer to the product described.

Preface

This guide describes how to install the AutoDome Easy.

Audience

This guide is intended for qualified installation and service personnel who are familiar with the applicable national and local electrical codes.

Document Conventions

Convention	Meaning
Bold	Denotes a part, item, or assembly.
<i>Italic</i>	Denotes a reference to another paragraph, figure or table.
<u>Underline</u>	Used to emphasize a point.
courier	Denotes the actual name of an object, the exact code that should be typed or a message returned from a system.

Symbols

You may encounter these symbols within the document. Explanatory text accompanies each symbol, which provides additional information detailing the operation or highlighting safety information.



NOTICE! Notices inform you of essential but non-critical information. Read these messages carefully as any directions or instructions contained therein can help you avoid making mistakes.



CAUTION! Cautionary messages provide critical information that help you reduce the chance of losing data or damaging the system. Please heed these messages.



WARNING! Warnings highlight information, that if overlooked may cause damage to the system or result in personal injury. Take warnings seriously.



DANGER! Danger messages denote the presence of electrical equipment that may cause electric shock or electrocution. Take care when you see this symbol to avoid serious injury or death.

Customer Support and Service

If this unit needs service, contact the nearest Bosch Security Systems Service Center for authorization to return and shipping instructions.

Service Centers

USA

Phone: 800-366-2283 or 585-340-4162

Fax: 800-366-1329

Email: cctv.repair@us.bosch.com

Technical Support

Phone: 800-326-1450

Email: technical.support@us.bosch.com

CCTV Spare Parts

Phone: 800-894-5215 or 408-957-3065

Fax: 408-935-5938

Email: BoschCCTVparts@ca.slr.com

Canada

Phone: 514-738-2434

Fax: 514-738-8480

Europe, Middle East & Asia Pacific Region

Phone: 44 (0) 1495 274558

Fax: 44 (0) 1495 274280

Email: rmahelpdesk@solectron.com

For additional information, see www.boschsecurity.com

Important Safeguards

1. Read, Follow, and Retain Instructions - All safety and operating instructions should be read and followed before operating the unit. Retain instructions for future reference.
2. Heed Warnings - Adhere to all warnings on the unit and in the operating instructions.
3. Attachments - Attachments not recommended by the product manufacturer should not be used, as they may cause hazards.
4. Installation Cautions - Do not place this unit on an unstable stand, tripod, bracket, or mount. The unit may fall, causing serious injury to a person and serious damage to the unit. Use only manufacturer-recommended accessories, or those sold with the product. Mount the unit per the manufacturer's instructions. Appliance and cart combination should be moved with care. Quick stops, excessive force, or uneven surfaces may cause the appliance and cart combination to overturn.
5. Cleaning - Unplug the unit from the outlet before cleaning. Follow any instructions provided with the unit. Generally, using a damp cloth for cleaning is sufficient. Do not use liquid cleaners or aerosol cleaners.
6. Servicing - Do not attempt to service this unit yourself. Opening or removing covers may expose you to dangerous voltage or other hazards. Refer all servicing to qualified service personnel.
7. Damage Requiring Service - Unplug the unit from the main AC power source and refer servicing to qualified service personnel under the following conditions:
 - When the power supply cord or plug is damaged.
 - If liquid has been spilled or an object has fallen into the unit.
 - If the unit has been exposed to water and/or inclement weather (rain, snow, etc.).
 - If the unit does not operate normally, when following the operating instructions. Adjust only those controls specified in the operating instructions. Improper adjustment of other controls may result in damage, and require extensive work by a qualified technician to restore the unit to normal operation.
 - If the unit has been dropped or the cabinet damaged.
 - If the unit exhibits a distinct change in performance, this indicates that service is needed.
8. Replacement Parts - When replacement parts are required, the service technician should use replacement parts specified by the manufacturer or that have the same characteristics as the original part. Unauthorized substitutions may result in fire, electrical shock or other hazards.
9. Safety Check - Upon completion of servicing or repairs to the unit, ask the service technician to perform safety checks to ensure proper operating condition.
10. Power Sources - Operate the unit only from the type of power source indicated on the label. If unsure of the type of power supply to use, contact your dealer or local power company.
 - For units intended to operate from battery power, refer to the operating instructions.
 - For units intended to operate with External Power Supplies, use only the recommended approved power supplies.
 - For units intended to operate with a limited power source, this power source must comply with EN60950. Substitutions may damage the unit or cause fire or shock.
 - For units intended to operate at 24VAC, normal input voltage is 24VAC. Voltage applied to the unit's power input should not exceed 30VAC.
 User-supplied wiring, from the 24VAC supply to unit, must be in compliance with electrical codes (Class 2 power levels). Do not ground the 24VAC supply at the terminals or at the unit's power supply terminals.
11. Coax Grounding - If an outside cable system is connected to the unit, ensure that the cable system is grounded. U.S.A. models only - Section 810 of the National Electrical Code, ANSI/NFPA No.70, provides information regarding proper grounding of the mount and supporting structure, grounding of the coax to a discharge unit, size of grounding conductors, location of discharge unit, connection to grounding electrodes, and requirements for the grounding electrode.
12. Grounding - This unit may be equipped with a 3-wire grounding plug (a plug with a third pin, for grounding). This safety feature allows the plug to fit into a grounding power outlet only. If unable to insert the plug into the outlet, contact an electrician to arrange replacement of the obsolete outlet. Do not defeat the safety purpose of the grounding plug.
 - Outdoor equipment should only be connected to the unit's inputs after this unit has had its grounding plug connected to a grounded outlet or its ground terminal properly connected to a ground source.
 - The unit's input connectors must be disconnected from outdoor equipment before disconnecting the grounding plug or grounding terminal.
 - Proper safety precautions such as grounding should be followed for any outdoor device connected to this unit.
13. Lightning - For added protection during a lightning storm, or when this unit is left unattended and unused for long periods of time, unplug the unit from the wall outlet and disconnect the cable system. This will prevent damage to the unit due to lightning and power line surges.

For Indoor Product

1. Water and Moisture - Do not use this unit near water - for example, in a wet basement, in an unprotected outdoor installation or in any area classified as a wet location.
2. Object and Liquid Entry - Never push objects of any kind into this unit through openings, as they might touch dangerous voltage points or create short circuits, resulting in a fire or electrical shock. Never spill liquid of any kind on the unit.

Power Cord and Power Cord Protection - For units intended to operate with 230VAC, 50Hz, the input and output power cord must comply with the latest versions of IEC Publication 227 or IEC Publication 245.
3. Power supply cords should be routed so they are not likely to be walked on or pinched. Pay particular attention to location of cords and plugs, convenience receptacles, and the point of exit from the appliance.
4. Overloading - Do not overload outlets and extension cords; this can result in a risk of fire or electrical shock.

For Outdoor Product

Power Lines - An outdoor system should not be located in the vicinity of overhead power lines, electric lights or power circuits, or where it may contact such power lines or circuits. When installing an outdoor system, extreme care should be taken to keep from touching power lines or circuits, as this contact might be fatal. U.S.A. models only - refer to the National Electrical Code Article 820 regarding installation of CATV systems.

For Rack-mount Product

1. Ventilation - Do not place this equipment in a built-in installation or rack, unless proper ventilation is provided, or the manufacturer's instructions were followed. The equipment must not exceed its maximum operating temperature requirements.
2. Mechanical Loading - When rack-mounting the equipment, ensure that a hazardous condition is not created by uneven mechanical loading.

Safety Precautions

	CAUTION RISK OF ELECTRIC SHOCK, DO NOT OPEN!	
---	--	---

CAUTION: TO REDUCE THE RISK OF ELECTRIC SHOCK, DO NOT REMOVE COVER (OR BACK). NO USER SERVICEABLE PARTS INSIDE. REFER SERVICING TO QUALIFIED SERVICE PERSONNEL.

	This symbol indicates the presence of uninsulated "dangerous voltage" within the product's enclosure that can cause an electric shock.
---	--

	This symbol indicates the presence of important operating and maintenance (servicing) instructions in the literature accompanying the appliance.
---	--

	Installation should be performed by qualified service personnel only in accordance with the National Electrical Code or applicable local codes.
---	---

	Power Disconnect. Units with or without ON-OFF switches have power supplied to the unit whenever the power cord is inserted into the power source; however, the unit is operational only when the ON-OFF switch is in the ON position. The power cord is the main power disconnect for all units.
--	--

	Modifications Caution: Changes or modifications not expressly approved by the party responsible for compliance could void the user's authority to operate the equipment.
---	--

FCC & ICES INFORMATION

(U.S.A. and Canadian Models Only)

This device complies with part 15 of the FCC Rules. Operation is subject to the following two conditions:

- (1) This device may not cause harmful interference, and
- (2) This device must accept any interference received, including interference that may cause undesired operation.

NOTE: This equipment has been tested and found to comply with the limits for a Class A digital device, pursuant to Part 15 of the FCC Rules and ICES-003 of Industry Canada. These limits are designed to provide reasonable protection against harmful interference when the equipment is operated in a commercial environment. This equipment generates, uses and radiates radio frequency energy, and if not installed and used in accordance with the instruction manual, may cause harmful interference to radio communications. Operation of this equipment in a residential area is likely to cause harmful interference, in which case the user will be required to correct the interference at his expense.

Intentional or unintentional changes or modifications, not expressly approved by the party responsible for compliance, shall not be made. Any such changes or modifications could void the user's authority to operate the equipment. If necessary, the user should consult the dealer or an experienced radio/television technician for corrective action. The user may find the following booklet, prepared by the Federal Communications Commission, helpful: How to Identify and Resolve Radio-TV Interference Problems. This booklet is available from the U.S. Government Printing Office, Washington, DC 20402, Stock No. 004-000-00345-4.



WARNING: This is a Class A product. In a domestic environment, this product may cause radio interference, in which case, the user may be required to take adequate measures.

Sécurité

Attention : l'installation doit exclusivement être réalisée par du

	ATTENTION RISQUE D'ÉLECTROCUTION. NE PAS OUVRIR !	
ATTENTION : POUR ÉVITER TOUT RISQUE D'ÉLECTROCUTION, N'ESSAYEZ PAS DE RETIRER LE CAPOT (OU LE PANNEAU ARRIÈRE). CET APPAREIL NE CONTIENT AUCUN COMPOSANT SUSCEPTIBLE D'ÊTRE RÉPARÉ PAR L'UTILISATEUR. CONFIEZ LA RÉPARATION DE L'APPAREIL À DU PERSONNEL QUALIFIÉ.		
	Ce symbole signale que le produit renferme une « tension potentiellement dangereuse » non isolée susceptible de provoquer une électrocution.	
	Ce symbole invite l'utilisateur à consulter les instructions d'utilisation et d'entretien (dépannage) reprises dans la documentation qui accompagne l'appareil.	
	Attention: l'installation doit exclusivement être réalisée par du personnel qualifié, conformément au code national d'électricité américain (NEC) ou au code d'électricité local en vigueur.	
	Coupure de l'alimentation. Qu'ils soient pourvus ou non d'un commutateur ON/OFF, tous les appareils reçoivent de l'énergie une fois le cordon branché sur la source d'alimentation. Toutefois, l'appareil ne fonctionne réellement que lorsque le commutateur est réglé sur ON. Le débranchement du cordon d'alimentation permet de couper l'alimentation des appareils.	

Sicherheitshinweise

	VORSICHT ELEKTRISCHE SPANNUNG. NICHT ÖFFNEN!	
<p>VORSICHT: UM EINEN ELEKTRISCHEN SCHLAG ZU VERMEIDEN, IST DIE ABDECKUNG (ODER RÜCKSEITE) NICHT ZU ENTFERNEN. ES BEFINDEN SICH KEINE TEILE IN DIESEM BEREICH, DIE VOM BENUTZER GEWARTET WERDEN KÖNNEN. LASSEN SIE WARTUNGSARBEITEN NUR VON QUALIFIZIERTEM WARTUNGSPERSONAL AUSFÜHREN.</p>		



	<p>Das Symbol macht auf nicht isolierte „gefährliche Spannung“ im Gehäuse aufmerksam. Dies kann zu einem elektrischen Schlag führen.</p>
---	--

	<p>Der Benutzer sollte sich ausführlich über Anweisungen für die Bedienung und Instandhaltung (Wartung) in den begleitenden Unterlagen informieren.</p>
---	---

	<p>Achtung! Die Installation sollte nur von qualifiziertem Kundendienstpersonal gemäß jeweils zutreffender Elektrovorschriften ausgeführt werden.</p>
--	---

	<p>Unterbrechung des Netzanschlusses. Geräte mit oder ohne Netzschalter haben Spannung am Gerät anliegen, sobald der Netzstecker in die Steckdose gesteckt wird. Das Gerät ist jedoch nur betriebsbereit, wenn der Netzschalter (EIN/AUS) auf EIN steht. Wenn das Netzkabel aus der Steckdose gezogen wird, ist die Spannungszuführung zum Gerät vollkommen unterbrochen.</p>
---	---

Precauciones de Seguridad

	PRECAUCION PELIGRO DE DESCARGAS ELÉCTRICAS, NO ABRIR!	
<p>PRECAUCIÓN: PARA DISMINUIR EL RIESGO DE DESCARGA ELÉCTRICA, NO RETIRE LA CUBIERTA (NI LA PARTE POSTERIOR). NO EXISTEN PIEZAS DE RECAMBIO EN EL INTERIOR DEL EQUIPO. EL PERSONAL DE SERVICIO CUALIFICADO SE ENCARGA DE REALIZAR LAS REPARACIONES.</p>		

	<p>Este símbolo indica que existen puntos de tensión peligrosos sin aislamiento dentro de la cubierta de la unidad. Estos puntos pueden constituir un riesgo de descarga eléctrica.</p>
---	---

	<p>El usuario debe consultar las instrucciones de funcionamiento y mantenimiento (reparación) en la documentación que se suministra con el aparato.</p>
---	---

	<p>Atención: la instalación la debe realizar únicamente personal cualificado de conformidad con el National Electric Code o las normas aplicables en su país.</p>
--	---

	<p>Desconexión de la alimentación. Las unidades con o sin interruptores de encendido/apagado reciben alimentación eléctrica siempre que el cable de alimentación esté conectado a la fuente de alimentación. Sin embargo, la unidad sólo funciona cuando el interruptor está en la posición de encendido. El cable de alimentación es la principal fuente de desconexión de todas las unidades.</p>
---	---

Veiligheidsmaatregelen

	VOORZICHTIG GEVAAR VOOR ELEKTRISCHE SCHOK NIET OPENEN!	
VOORZICHTIG: OPEN DE BEHUIZING OF DE ACHTERKANT VAN HET APPARAAT NIET. ZO VERMINDERT U HET RISICO OP ELEKTRISCHE SCHOKKEN. IN HET APPARAAT BEVINDEN ZICH GEEN ONDERDELEN DIE U ZELF KUNT REPAREREN. LAAT SERVICE EN ONDERHOUD UITVOEREN DOOR GEKWALIFICEERD PERSONEEL.		
	Dit symbool geeft aan dat er binnen in het apparaat ongeïsoleerde, gevaarlijke spanning aanwezig is die mogelijk elektrische schokken kan veroorzaken.	
	De gebruiker dient de bedienings- en onderhoudsvorschriften te raadplegen in de documentatie die werd meegeleverd met het apparaat.	
	Attentie: het apparaat mag alleen door gekwalificeerd personeel worden geïnstalleerd. De installatie dient in overeenstemming met de nationale elektrische richtlijnen of de van toepassing zijnde lokale richtlijnen te worden uitgevoerd.	
	Spanning uitschakelen. Apparatuur met of zonder-aan-uitschakelaar staat onder spanning zolang de stekker is aangesloten op de wandcontactdoos. De apparatuur is uitsluitend in werking als de aan-uitschakelaar aan staat. Het netsnoer is de "hoofdschakelaar" voor alle apparatuur.	

Sicurezza

	ATTENZIONE PERICOLO DI SCOSSA ELETTRICA. NON APRIRE.	
ATTENZIONE: PER RIDURRE IL RISCHIO DI SCOSSA ELETTRICHE NON RIMUOVERE LA COPERTURA (O IL PANNELLO POSTERIORE). L'UNITÀ NON CONTIENE COMPONENTI INTERNI RIPARABILI DALL'UTENTE. PER QUALSIASI INTERVENTO, RIVOLGERSI A PERSONALE TECNICO QUALIFICATO.		
	Questo simbolo indica la presenza di "tensione pericolosa" non isolata all'interno del contenitore del prodotto. Ciò comporta un potenziale rischio di scosse elettriche.	
	Si consiglia di consultare le istruzioni operative e di manutenzione (interventi tecnici) contenute nella documentazione fornita con il dispositivo.	
	Attenzione: l'installazione deve essere effettuata esclusivamente da personale tecnico qualificato in conformità con il National Electrical Code o con le normative locali vigenti.	
	Scollegamento dell'alimentazione. Le unità dotate o sprovviste di interruttori ON-OFF vengono alimentate quando si inserisce il cavo nella presa dell'alimentazione. L'unità è tuttavia in funzione solo quando l'interruttore ON-OFF si trova nella posizione ON. Il cavo di alimentazione costituisce il dispositivo di scollegamento dell'alimentazione principale per tutte le unità.	

Medidas de Segurança

	CUIDADO RISCO DE CHOQUE ELÉCTRICO. NÃO ABRIR!	
---	--	---

CUIDADO: PARA REDUZIR O RISCO DE CHOQUE ELÉCTRICO, NÃO RETIRE A TAMPA (OU A PARTE POSTERIOR). NO INTERIOR, NÃO EXISTEM PEÇAS QUE POSSAM SER REPARADAS PELO UTILIZADOR. REMETA A ASSISTÊNCIA PARA OS TÉCNICOS QUALIFICADOS.

 Este símbolo indica a presença de "tensão perigosa" não isolada dentro da estrutura do produto, o que pode constituir risco de choque eléctrico.

 O utilizador deve consultar as instruções de funcionamento e manutenção (assistência) nos documentos que acompanham o aparelho.

 Atenção: a instalação deve ser executada apenas por técnicos qualificados da assistência, de acordo com o código eléctrico nacional ou os códigos locais aplicáveis.

 Corte de corrente. As unidades com ou sem interruptores ON-OFF (ligar/desligar) recebem corrente sempre que o fio de alimentação está introduzido na fonte de alimentação; contudo, a unidade apenas está operacional quando o interruptor ON-OFF está na posição ON. O fio de alimentação destina-se a desligar a corrente em todas as unidades.

Zasady bezpieczeństwa

	UWAGA EZPIECZEŃSTWO PORAZENIA PRĄ ELEKTRYCZNYM. NIE OTWIERAĆ!	
---	--	---

UWAGA: ZE WZGLEDU NA NIEBEZPIECZENSTWO PORAZENIA PRĄDEM NIE WOLNO OTWIERAĆ POKRYWY. W ŚRODKU NIE MA ŻADNYCH ELEMENTÓW, KTÓRE MOGA BYĆ NAPRAWIANE PRZEZ UŻYTKOWNIKA. NAPRAWĘ NALEŻY POWIERZYĆ AUTORYZOWANEMU PUNKTOWI SERWISOWEMU.

 Błyskawica ze strzałką wewnątrz trójkąta równobocznego ma zadanie zwrócić uwagę użytkownika na obecność nieizolowanego "niebezpiecznego napięcia" wewnątrz obudowy urządzenia, o wielkości stwarzającej niebezpieczeństwo porażenia prądem.

 Wykrzyknik wewnątrz trójkąta równobocznego ma za zadanie zwrócić uwagę użytkownika na ważności, związane z obsługą i konserwacją urządzenia, zamieszczone w Instrukcji obsługi.

OSTRZEŻENIE: ABY UNIKNĄĆ POŻARU LUB PORAZENIA PRĄDEM NIE WOLNO WYSTAWIAC NA DZIAŁANIE DESZCZU LUB WILGOCI URZĄDZENIA, KTÓRE NIE ZOSTAŁY ZAPROJEKTOWANE DO UŻYWKANIA SPECJALNIE NA OTWARTYM POWIETRZU.

 Uwaga: Instalacje urządzenia powinien wykonać tylko wykwalifikowany personel, zgodnie z przepisami NEClub odpowiednimi przepisami miejscowymi.

 Odlączenie zasilania. Urządzenia zarówno nie posiadające, jak i posiadające wyłączniki WL-WYL znajdują się pod napięciem, jeżeli tylko przewód zasilający jest połączony ze źródłem zasilania. Jednakże urządzenie działa tylko wtedy, gdy wyłącznik znajduje się w położeniu WL. Przewód zasilający jest głównym odłącznikiem zasilania dla wszystkich rodzajów urządzeń.

安全预防措施

	CAUTION RISK OF ELECTRIC SHOCK. DO NOT OPEN!	
<p>注意：为避免受到电击，不要拆除机盖（或后盖）。用户不得擅自维修里面的部件。有关维修事项，请咨询合格的维修人员。</p>		

	<p>此符号表示产品机壳内存在未绝缘的“危险电压”。这可能导致电击。</p>
---	--

	<p>用户应参照设备附带的操作和维护（维修）说明。</p>
---	-------------------------------

	<p>注意：安装须由合格的维修人员遵照美国国家电工标准或相关电气规则进行。</p>
---	--

	<p>断开电源。在电源线插入电源时，配备或未配备 ON-OFF 开关的设备都已通电；但设备只有在 ON-OFF 开关处于 ON 位置时才能工作。对于所有设备，电源线是断开电源的主要方式。</p>
---	---

Table of Contents

1	Unpacking	1
1.1	Parts List	1
1.2	Additional Tools Required	1
1.3	Safety Rules	2
2	Description	3
3	Installing the AutoDome Easy	3
3.1	Mounting the AutoDome Easy	3
4	Preparing the Wiring	4
4.1	Control	4
4.2	Video	4
4.3	Power	4
4.4	Alarm	5
5	Connections	5
5.1	Connecting to the Biphase	5
5.1.1	Direct Control	5
5.1.2	Daisy Chaining	6
5.2	Connecting the Video	7
5.3	Connecting the Power	7
5.4	Connecting the Alarm Input	7
6	Address (ID)	8
6.1	Setting the Address (ID)	8
7	Setting Protocol and Video Format	10
8	Installing the AutoDome Easy	11
8.1	Surface Mount	11
8.1.1	Preparing the Drywall Ceiling for Installation	11
8.1.2	Preparing the Suspension Ceiling for Installation	12
8.1.3	Installing the Base to the Mounting Plate	12
8.1.4	Powering On	13
8.1.5	Installing the Base to a Junction Box	13
9	Basic Operation	14
9.1	Keyboard Control	14
9.2	Command Structure	14
10	Program and Operation	15
10.1	Menu Navigation	15

10.2	Main Menu	15
10.3	Preset Menu	16
10.3.1	Setting and Saving Presets	16
10.3.2	Recalling a Preset Position	17
11	Creating Titles	17
12	Tour Menu	18
12.1	Setting a Tour	18
12.2	Running / Stopping a Tour	19
13	Auto Pan Menu	19
13.1	Set Auto Scans	19
13.2	Run Auto Pan	20
14	Sector Menu	20
15	Alarm Menu	21
15.1	Releasing an Alarm	21
16	Camera Setup Menu	22
16.1	Focus Control Menu	22
16.2	WB Control Menu	23
16.3	AE Control Menu	24
16.4	L/L Control Menu	26
16.5	Picture Menu	27
16.6	Initialize Camera Menu	27
17	Dome Setup Menu	28
17.1	Home Function	29
17.2	Initialize Dome Menu	30
17.3	Dome Information Menu	30
18	Keyboard Commands by Number	31
19	Troubleshooting	32
20	Preventive Maintenance	32
21	Spare Parts List	32

1 Unpacking

This equipment should be unpacked and handled with care. If an item appears to have been damaged in shipment, notify the shipper immediately.

Verify that all the parts listed in Section 1.1: *Parts List* are included. If any items are missing, notify your Bosch Security Systems Sales or Customer Service Representative.

The original packing carton is the safest container in which to transport the unit and must be used if returning the unit for service. Save it for possible future use.

1.1 Parts List

The AutoDome Easy includes the following components:

- One (1) PTZ Dome (Dome camera)
- One (1) accessory kit including (part number - 9965 300 00648)
 - One (1) Locking Torx Wrench (T-10)
 - One (1) Locking Torx Wrench (T-20)
 - Three (3) tapping screws
 - Three (3) plastic anchors
- One (1) mounting bracket
- One (1) user manual

1.2 Additional Tools Required

- No. 2 Phillips screwdriver

1.3 Safety Rules

To ensure safety, the following warnings are specified:

- The device must be installed and maintained by skilled technical personnel.
- Connect the device to a power source corresponding to the indications given on the marking label.
- Use only the attachments/accessories specified by the manufacturer.
- Unplug the device during lightning storms or when unused for long periods of time.
- Do not use the device near water.
- Do not use the device in the presence of inflammable substances.
- Do not allow children or unauthorized personnel to use the device.
- Do not block any ventilation openings.
- Keep this manual for future reference.

2 Description

The AutoDome Easy keyboard controller and camera make up the building blocks for any surveillance/security system. By using multiple keyboard controllers and multiple dome cameras, no place is too large for monitoring. Extensible and flexible architecture facilities remote control functions for a variety of external switching devices such as multiplexers and DVRs (see Figure 2.1 for sample configuration).

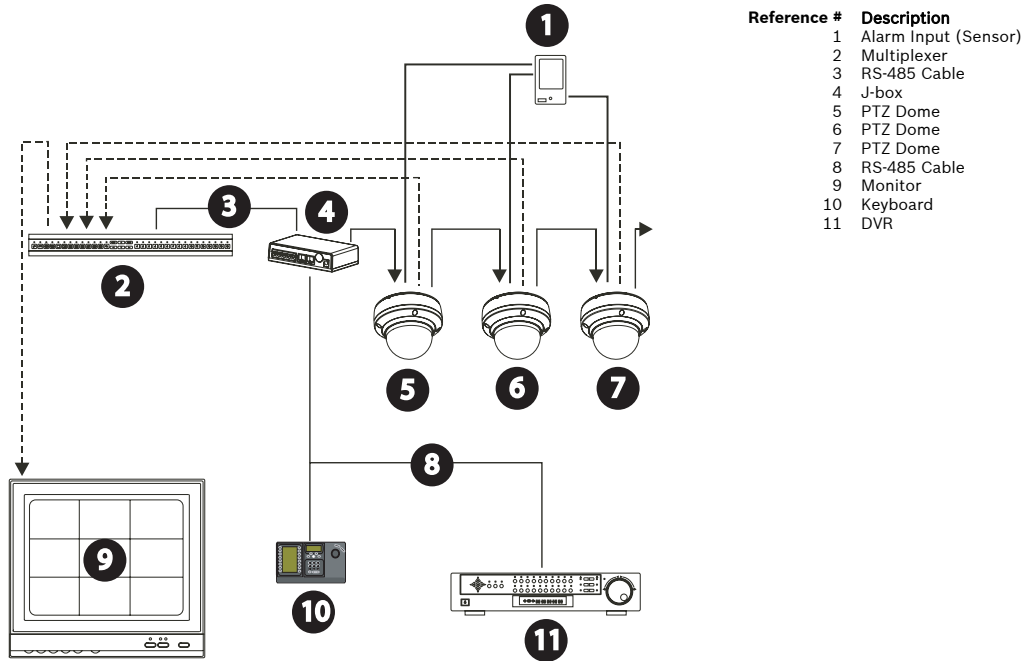

Fig. 2.1 System Configuration

3 Installing the AutoDome Easy

This chapter outlines the procedures required to install the AutoDome Easy. Installation should be made by qualified service personnel and conform to all local codes.

3.1 Mounting the AutoDome Easy

The AutoDome Easy can be surface or wall mounted. The appropriate mount should be installed before installing the AutoDome Easy. For specific directions on mounting the unit, see the manual that came with your mount.

4 Preparing the Wiring

There are four (4) types of wires required: control, video, power, and alarm. Each section provides the specifications for the recommended wire.



CAUTION! Installation should only be performed by qualified service personnel in accordance with the National Electrical Code or applicable local codes.

4.1 Control

The control wire from the head end should use a twisted-shielded pair recommended Belden 8760 or equivalent with a maximum length of 1.2 km (4000 ft).

Biphase (shielded 2-wire, half-duplex, multi-drop, 1.2 km (4000 ft.) cable limit), is the standard Bosch protocol used to send Pan/Tilt/Zoom control over 2-wire shielded twisted pair (STP). The AutoDome Easy has an internal 110 Ω termination resistor between the biphase(+) and biphase(-).

The shield connects to the Head End controller and not to the AutoDome Easy.



CAUTION! The biphase shield must be connected to the head end only.

Description	Specification
Cable Type	STP - Shielded Twisted Pair Belden 8760 recommended
Distance	1.2 km (4000 ft)
Transmission Rate	31.25 KHz
Gage	1.02 mm (18 AWG)
Internal Termination	110 Ω
Connector	Mating connector with flying leads
Voltage	4 Vp-p

4.2 Video

The video coax cable should use a shield coverage copper braid 95% and standard copper center conductor. Recommended cables are RG-59, RG-6/U, or RG-11U.

Cable Type	Maximum Distance
RG-59/U	300 m (1000 ft)
RG-6/U	450 m (1500 ft)
RG-11/U	600 m (2000 ft)
Size	O.D. between 4.6 mm (0.181 in.) and 7.9 mm (0.312 in.)
Shield	Copper braid: 95%
Central Conductor	Standard copper center
Terminal Connector	BNC

4.3 Power

The recommended power cable is a 2-conductor, 14-18 gage cable, depending on the distance. Refer to the wiring distance guide Table 4.1 on page 5.

	VA / Watts	14 AWG (2.5 mm)	16 AWG (1.5 mm)	18 AWG (1.0 mm)
24 VAC to AutoDome Easy	10 W	1130 ft(344 m)	711 ft (217 m)	448 ft (137 m)
12 VD C to AutoDome Easy	10 W	285 ft (87 m)	179 ft (55 m)	112 ft (34 m)

4.4 Alarm

The recommended optional alarm input cable is a 2-conductor, 18-22 gage cable, depending on the distance. Refer to the wiring distance guide Table 4.1 on page 5.

Wire Size		Maximum Distance	
AWG	mm	feet	meters
22	0.644	500	152.4
18	1.024	800	243.8

Table 4.1 Wiring Distance Guide

5 Connections

Follow the instructions below to terminate all connections as described.

Color	Description
Black	Biphase (+)
Brown	Biphase (-)
Red	AC24 V / DC12 V
Orange	AC24 V / DC12 V
Blue	ALARM COMMON
Violet	ALARM IN

Table 5.1 Connection Cable Description

5.1 Connecting to the Biphase

The AutoDome Easy camera can be controlled remotely by an external device or control system, such as a control keyboard, using biphase.

5.1.1 Direct Control

To connect the biphase configuration, do the following:

1. Locate the cable assembly with a two (2) pin black mating connector on one end and the brown and black flying leads on the other end.
2. Connect the biphase+ from the controller to the black lead and secure.
3. Connect the biphase- from the controller to the brown lead and secure.
4. Connect shield of the cable to the Head End controller.

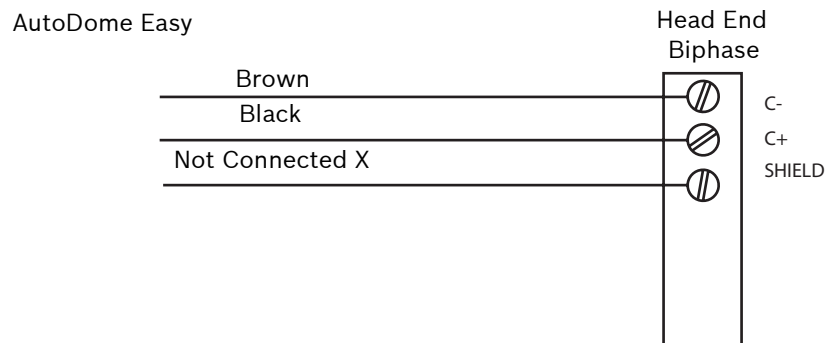

Fig. 5.1 Biphase Direct Control

5.1.2 Daisy Chaining

In a daisy chain configuration, where multiple domes are connected, the termination switch must be turned off for all but the last dome. The AutoDome Easy can be daisy chained up to a maximum of four (4) domes. To daisy chain the unit, do the following:

1. Loosen all bubbles in the daisy chain sequence except for the last one. Use the torx wrench provided to remove the four (4) tamper-resistant screws on each bubble.
2. Carefully loosen each bubble and allow it to hang from the safety tether.
3. Locate the SW601 switch and slide to the OFF position except for last dome in the chain.



NOTICE! See Section 6: *Address (ID)* to set the camera ID before replacing the bubble.

4. Locate the cable assembly on the first camera with a two (2) pin black mating connector on one end and the brown and black flying leads on the other end.
5. Connect the biphase(+) from the controller to the first camera black lead and secure.
6. Connect the biphase(-) from the controller to the brown lead on the first camera and secure.
7. Connect the biphase(+) from the first camera black lead to the second camera black lead and secure.
8. Connect the biphase(-) from the first camera brown lead to the second camera brown lead and secure.
9. Repeat steps as required for up to four (4) cameras.
10. Connect the shield of the cable to the Head End controller. You do not need to connect the shield to any AutoDome Easy.

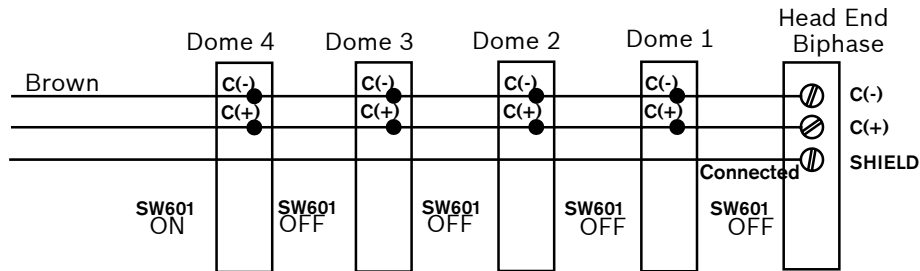

Fig. 5.2 Daisy Chain Configuration

SW601	1	Diagram
Terminated	ON	
Not Terminated	OFF	

Table 5.2 Setting the Unit for Termination

5.2 Connecting the Video

Coaxial cable terminated with BNC connectors is the most common method for transmitting composite video. To connect the video, do the following:

1. Terminate the coaxial cable from the head end system with a male BNC connector.
2. Connect the head end video cable to the yellow Video Out connector from the base of the camera.

5.3 Connecting the Power

To connect the power, do the following:



WARNING! This unit accepts 24 VAC or 12 V DC, 1 A power only. Do not connect 120 V or 230 V to this camera.

1. Locate the cable assembly with a two (2) pin mating connector on one end and the orange and red flying leads on the other end.
2. Connect one lead of the 12 V DC or 24 VAC power source to the red wire.
3. Connect one lead of the 12 V DC or 24 VAC power source to the orange wire.



NOTICE! Use certified / Listed Class 2 power supply transformer only.

5.4 Connecting the Alarm Input

The AutoDome Easy provides one (1) alarm input. This alarm input can be activated by dry contact devices, which triggers the dome camera to move to a pre-position. The default alarm state is normally open but may be programmed to be normally closed. See Section 10: *Program and Operation* for configuring alarm input. To connect the alarm input, do the following:

1. Locate the cable assembly with a two (2) pin blue mating connector on one end and the blue and violet flying leads on the other end.
2. Connect the ground of the alarm source dry contact to the blue wire (alarm common).
3. Connect the alarm out of the alarm source dry contact to the violet wire (alarm input).

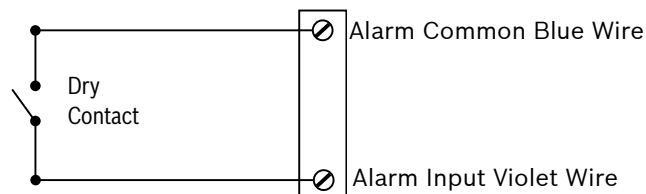

Fig. 5.3 N.O. - Normally Open Non-supervised Connections



NOTICE! All the connectors marked GND are common.

6 Address (ID)

Each AutoDome Easy camera must have a unique address (ID). When installing multiple dome cameras using a DVR, it is suggested that the dome camera address match the DVR input number (for example: Input 1 = Dome 1, Input 2 = Dome 2, etc...). Set a unique camera address (ID) using the switch selections inside the bubble.

6.1 Setting the Address (ID)

To set the unique AutoDome Easy ID address, do the following:

1. Loosen the bubble's four (4) tamper-resistant screws using the torx wrench provided.
2. Carefully lift the bubble and set it aside.
3. Locate the SW501 switch.
4. Set the switches based on Table 6.1.

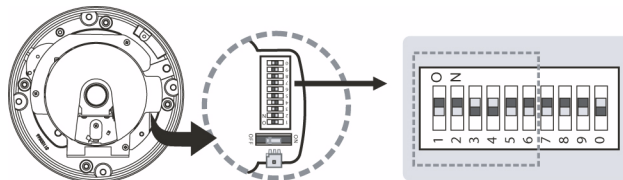

Fig. 6.1 Setting the AutoDome Easy Address (ID)

ID Address	SW1	SW2	SW3	SW4	SW5	SW6	ID Address	SW1	SW2	SW3	SW4	SW5	SW6
1	ON	OFF	OFF	OFF	OFF	OFF	33	ON	OFF	OFF	OFF	OFF	ON
2	OFF	ON	OFF	OFF	OFF	OFF	34	OFF	ON	OFF	OFF	OFF	ON
3	ON	ON	OFF	OFF	OFF	OFF	35	ON	ON	OFF	OFF	OFF	ON
4	OFF	OFF	ON	OFF	OFF	OFF	36	OFF	OFF	ON	OFF	OFF	ON
5	ON	OFF	ON	OFF	OFF	OFF	37	ON	OFF	ON	OFF	OFF	ON
6	OFF	ON	ON	OFF	OFF	OFF	38	OFF	ON	ON	OFF	OFF	ON
7	ON	ON	ON	OFF	OFF	OFF	39	ON	ON	ON	OFF	OFF	ON
8	OFF	OFF	OFF	ON	OFF	OFF	40	OFF	OFF	OFF	ON	OFF	ON
9	ON	OFF	OFF	ON	OFF	OFF	41	ON	OFF	OFF	ON	OFF	ON
10	OFF	ON	OFF	ON	OFF	OFF	42	OFF	ON	OFF	ON	OFF	ON
11	ON	ON	OFF	ON	OFF	OFF	43	ON	ON	OFF	ON	OFF	ON
12	OFF	OFF	ON	ON	OFF	OFF	44	OFF	OFF	ON	ON	OFF	ON
13	ON	OFF	ON	ON	OFF	OFF	45	ON	OFF	ON	ON	OFF	ON
14	OFF	ON	ON	ON	OFF	OFF	46	OFF	ON	ON	ON	OFF	ON
15	ON	ON	ON	ON	OFF	OFF	47	ON	ON	ON	ON	OFF	ON
16	OFF	OFF	OFF	OFF	ON	OFF	48	OFF	OFF	OFF	OFF	ON	ON
17	ON	OFF	OFF	OFF	ON	OFF	49	ON	OFF	OFF	OFF	ON	ON
18	OFF	ON	OFF	OFF	ON	OFF	50	OFF	ON	OFF	OFF	ON	ON
19	ON	ON	OFF	OFF	ON	OFF	51	ON	ON	OFF	OFF	ON	ON
20	OFF	OFF	ON	OFF	ON	OFF	52	OFF	OFF	ON	OFF	ON	ON
21	ON	OFF	ON	OFF	ON	OFF	53	ON	OFF	ON	OFF	ON	ON
22	OFF	ON	ON	OFF	ON	OFF	54	OFF	ON	ON	OFF	ON	ON
23	ON	ON	ON	OFF	ON	OFF	55	ON	ON	ON	OFF	ON	ON
24	OFF	OFF	OFF	ON	ON	OFF	56	OFF	OFF	OFF	ON	ON	ON
25	ON	OFF	OFF	ON	ON	OFF	57	ON	OFF	OFF	ON	ON	ON
26	OFF	ON	OFF	ON	ON	OFF	58	OFF	ON	OFF	ON	ON	ON
27	ON	ON	OFF	ON	ON	OFF	59	ON	ON	OFF	ON	ON	ON
28	OFF	OFF	ON	ON	ON	OFF	60	OFF	OFF	ON	ON	ON	ON
29	ON	OFF	ON	ON	ON	OFF	61	ON	OFF	ON	ON	ON	ON
30	OFF	ON	ON	ON	ON	OFF	62	OFF	ON	ON	ON	ON	ON
31	ON	ON	ON	ON	ON	OFF	63	ON	ON	ON	ON	ON	ON
32	OFF	OFF	OFF	OFF	OFF	ON							

Table 6.1 ID Settings

7 Setting Protocol and Video Format

The factory default settings for switches 8, 9, and 0 are set for the correct operation. However, if the camera is operating incorrectly, the proper configuration is the following:

- Switch 8 - set to match the appropriate video format;
NTSC (60 Hz) ON
- or -
PAL (50 Hz) OFF.
- Switches 9 and 0 - set to biphase protocol (see Table 7.1).



NOTICE! The error message: PROTOCOL IS NOT MATCHED is displayed during the power-up cycle if switches 9 and 0 are not set correctly.

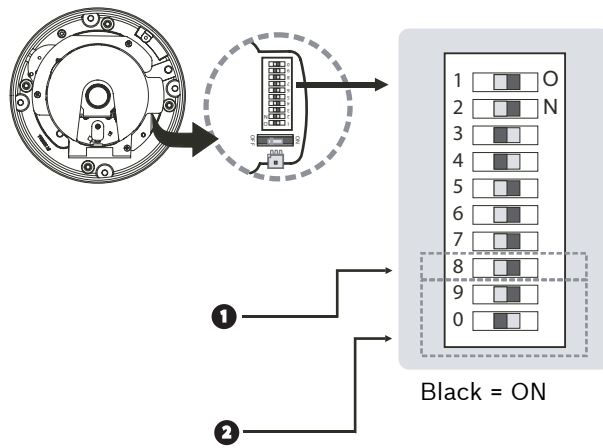

Fig. 7.1 AutoDome Easy Camera Function and Protocol Selection Switches

Reference #	Description
1	Dome Camera Function
2	PDome Camera Protocol Function

S/W No.	ON	OFF	Function
8	NTSC	PAL	NTSC/PAL

Table 7.1 Dome Camera Function

No. 9	No. 0	Protocol
ON	OFF	Biphase

Table 7.2 Dome Camera Protocol Function

8 Installing the AutoDome Easy

This chapter details how to install the AutoDome Easy for an in-ceiling, wall, or pipe mount.

8.1 Surface Mount

The mounting plate (included) is used for ceiling installation. The unit may be mounted to a hard surface or to a suspended ceiling tile.

NOTICE! The image sensors in modern CCD cameras are highly sensitive and require special care for proper performance and extended lifetime. Follow the guidelines for optimum results with your camera:



- Do not expose to direct sunlight or bright spotlights in operating and nonoperating conditions.
- Avoid bright lights in the field of view of the camera. Bright lights cause a "smearing" effect, which is visible as white lines above and below the highlight. Prolonged exposure to bright lights may cause bleaching of the sensor's color filters. This will be visible as colored spots in the picture and is irreversible.

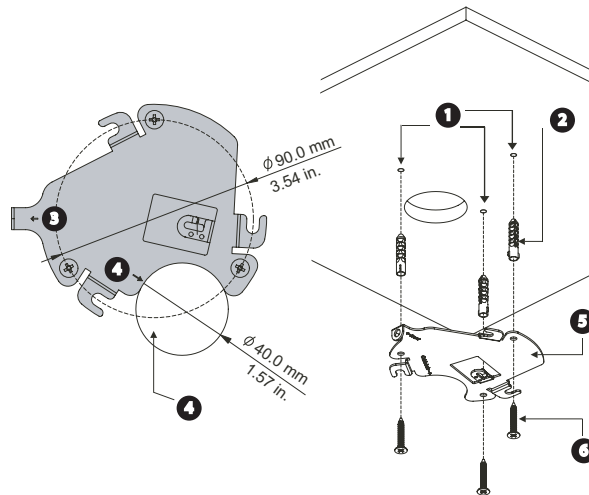

Fig. 8.1 Ceiling Mount Installation

Reference #	Description
1	Mounting Holes
2	Plastic Mounting Anchor
3	Front (Locking Tab)
4	Cable Hole (40 mm maximum)
5	Indentation
6	Mounting Bracket
7	M4 x 25 Tapping Screws

8.1.1 Preparing the Drywall Ceiling for Installation

To mount to a surface, follow the steps below:

1. Determine a proper location for the dome.
2. Use the supplied mounting bracket as a template to mark the three (3) mounting hole locations on the ceiling.
3. Locate the curved indentation (see Figure 8.1, Reference # 5) to mark the center of the hole.
4. Drill or cut the appropriate size hole required for the cables.

5. Drill the appropriate holes for the supplied anchors.
6. Insert the anchors.
7. Position the locking tab, as seen in Figure 8.1 reference #3, of the mounting plate facing the center toward the field of view for a 180 degree position.
8. Secure the mounting plate to the ceiling with the supplied screws.

8.1.2

Preparing the Suspension Ceiling for Installation

To mount to a rigid suspended ceiling, follow the steps below:



NOTICE! To avoid sagging ceiling tiles, the weight of the dome (approximately 2 lb) and all necessary wiring must be evenly supported.

1. Determine a proper location for the dome, and remove an adjacent ceiling tile.
2. Use the supplied mounting bracket as a template to mark the three (3) mounting hole locations on the ceiling.
3. Locate the curved indentation (see Figure 8.1, Reference # 5) to mark the center of the hole.
4. Drill or cut the appropriate size hole required for the cables.
5. Drill the appropriate holes for the mounting screws (not supplied).
6. Orient the locking tab, as seen in Figure 8.1 reference #3, of the mounting plate facing the center toward the field of view for a 180 degree position.
7. Secure the mounting plate to the ceiling with the appropriate screws (not supplied).

8.1.3

Installing the Base to the Mounting Plate

To install the base to a drywall or suspended ceiling using the supplied mounting plate, do the following:

1. Align the supplied mounting bracket with the cut cable hole.
2. Attach the mounting bracket to the ceiling using the supplied three (3) tapping screws.
3. Unlock the safety locking screw using the supplied Allen wrench.
4. Extract each wire through the cable hole.
5. Hang the dome camera to the mounting bracket using the safety wire.
6. Connect the prepared wiring in Section 5: *Connections* matching the colors of the wires.

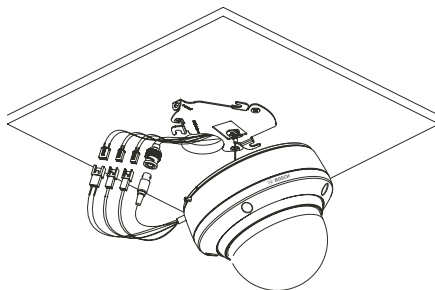

Fig. 8.2 Connecting the Cables

7. Align the dome camera with the mounting bracket.

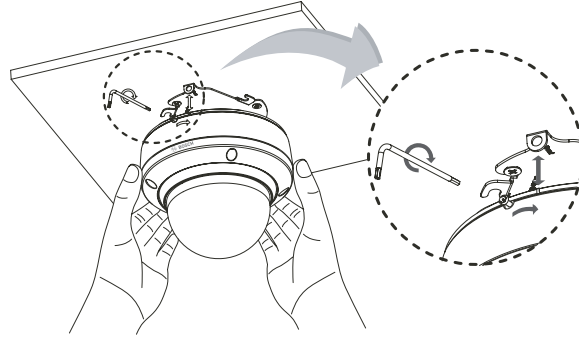

Fig. 8.3 Installing the Dome

8. Turn the dome camera to the right approximately 15 degrees.
9. Secure the safety locking screw.

8.1.4

Powering On

When AutoDome Easy's power is turned on, there is a five (5) second pause before the dome starts its *homing phase*. During the homing phase, the camera pans left and right and tilts up and down. It also adjusts the lens focus. The entire homing phase lasts approximately 40 seconds and displays the following splash screen throughout its homing phase START UP BOSCH Version 2.0.x.



NOTICE! The error message: PROTOCOL IS NOT MATCHED is displayed during the power-up cycle if switches 9 and 0 are not set correctly.

8.1.5

Installing the Base to a Junction Box

If it is not possible to drill a hole in the ceiling for wiring, it is recommended to use a junction box (not supplied). To mount a junction box, follow all standard procedures.



NOTICE! This mounting method does not require use of the supplied mounting plate.

To install the AutoDome Easy to a junction box, follow the steps below:

1. Carefully loosen the bubble by using the torx wrench provided to remove the four (4) tamper-resistant screws. Allow the bubble to hang from the safety tether.
2. Remove the appropriate two (2) (see Figure 8.4) black rubber plugs from the camera base.

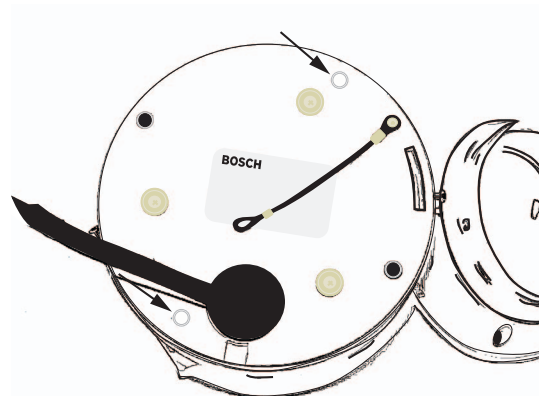

Fig. 8.4 Removing the Plugs from the Camera Base

3. Connect the prepared wiring in Section 5: *Connections* matching the colors of the wires.
4. Align the two (2) screws (not provided) with the junction box and secure the dome.
5. Re-attach the bubble.

9 Basic Operation

This section describes how to use the keyboard and details the keyboard command structure.

9.1 Keyboard Control

The following tables summarize the basic operations for a standard keyboard and the functions available to control an AutoDome Easy camera.

Typical Keyboard Features	Usage
Function Keys	Selects a specific control setting.
Number Keys	Inputs a number from 0 to 9.
Camera Key	Selects a camera number.
Enter Key	Inputs a selection.
Focus Key	Sets the lens focus or makes a menu selection in OSD mode.
Iris Key	Sets the lens iris setting or makes a menu selection in OSD mode.
Key LEDs	Indicates an active key.
LCD	Displays the current status.
Joystick	Controls a pan, tilt, and zoom AutoDome camera.

Table 9.1 Typical Keyboard Functions

Dome Operation	How to control
To Pan Side to Side	Move the joystick left or right.
To Tilt Up and Down	Move the joystick forward and back.
To Zoom In	Twist the joystick clockwise.
To Zoom Out	Twist the joystick counterclockwise.

Table 9.2 Typical Keyboard Controls for an AutoDome Easy Camera

9.2 Command Structure

Keyboard control commands are composed of a sequence of three (3) inputs with the following convention: 1) a **Function** key + 2) a **Command** number key(s) + 3) the **Enter** key.

Depending on the type of keyboard, the control function keys are labeled:

- **ON** or **AUX ON**
- **OFF** or **AUX OFF**
- **SET** or **SET SHOT**
- **SHOT** or **SHOW SHOT**

10 Program and Operation

The AutoDome Easy is programmed through the on-screen display (OSD) menus. Each on-screen display (OSD) shows a list of parameters or submenus that can be selected by the operator.

10.1 Menu Navigation

To access the **OSD** menus, open the **Main** menu by pressing **ON + 4 + 6 + ENTER**.



NOTICE! The main menu can not be accessed when an auto pan or preset tour is running. Press the joystick in any direction to stop the tour or auto pan.

Use the joystick to navigate through the menu. To navigate throughout the OSD menus, do the following:

- To scroll through the parameters, move the joystick up ↑ and down ↓.
- To edit the parameters or enter a submenu, move the joystick left ← and right →.
- To exit the submenu, move the cursor to **EXIT**, then move the joystick to the right →.

10.2 Main Menu

The **Main** menu provides access to all programmable AutoDome Easy settings. Press **ON + 4 + 6 + ENTER** to display the **Main** menu.

MAIN MENU PRESET TOUR AUTO PAN SECTOR ALARM CAMERA SETUP DOME SETUP EXIT
--

Menu	Description
Preset	Pre-selects and stores combinations of pan, tilt and zoom positions which allow a set view to be recalled. Also known as preset shot.
Tour	Accesses a sequence of preset shots combined to provide a pre-programmed tour of the area covered by an AutoDome Easy camera.
Auto Pan	Accesses a range of 1-4 for customized auto pan tours.
Sector	Breaks the total 360 degrees into eight sectors of 45 degrees each. Individual titles may be assigned to each sector.
Alarm	Accesses the alarm settings such as: input type, timeout options, and dwell time.
Camera Setup	Accesses adjustable camera settings such as: white balance, gain, sharpness, sync, backlight, and shutter.
Dome Setup	Controls miscellaneous dome operations such as: OSD, auto pivot, home function, and initialization (reset to factory defaults).
Exit	Exits the menu without saving the data.

10.3 Preset Menu

The preset menu is designed to create and edit up to 60 sequential preset titles. The preset must be saved prior to editing a title see section Section 10.3.1: *Setting and Saving Presets*.

MAIN MENU PRESET TOUR AUTO PAN SECTOR ALARM CAMERA SETUP DOME SETUP EXIT	PRESET MENU NUMBER: 01 TITLE: Scene 1 0/1234567890 1/1234567890 ** ** *===== 2/1234567890 3/1234567890 ===== 4/1234567890 5/1234567890 ===== SAVE AND EXIT EXIT W/O SAVE
---	--

Menu	Description
Number	Represents the presets which have been saved. Twisting the joystick with a preset number highlighted moves the camera to the saved preset location.
Title	Controls a 10-character scene name which is displayed when the AutoDome Easy moves to a scene (must be user defined via the Title OSD).
#/1234567890	Indicates the preset shot saved with a “*” symbol below the number.
Save and Exit	Saves the data and exits the menu.
Exit W/O Save	Exits the menu without saving the data.



NOTICE! Saving data is temporary. To save data permanently, select the **SAVE AND EXIT** command.

10.3.1 Setting and Saving Presets

The AutoDome Easy is designed to save up to 60 preset locations. Each preset location has a pan/tilt/zoom data capability which is defined by the user. To set a preset position, do the following:

1. Exit the OSD menu.
2. Move the joystick to the desired preset position.
3. Press **Set** + (1-60) + **ENTER**.
 A message, PRESET SAVING . . . is displayed on the screen.

If the user attempts to save over an existing preset shot, a confirmation message is displayed: OVERWRITE CURRENT SCENE?



NOTICE! If the message, Out of Sequence is displayed, a preset save is being attempted that is not available. All preset positions must be set in sequential order. To verify the next number in the sequence, enter the Preset menu and scroll through the saved presets. The last number displayed is the next available preset position.

10.3.2

Recalling a Preset Position

The AutoDome Easy is designed to recall up to 60 preset locations.

To recall a preset position do the following:

- ▶ Press **Shot** + (screen shot # 1-60) + **ENTER**. The AutoDome Easy displays the preset position with a user defined title in the upper left-hand corner. If the user attempts to recall a shot that has not been preset, an error, **DATA NOT PROGRAMMED** is displayed on the screen.



NOTICE! The preset position can not be accessed when an auto pan or preset tour is running. Press the joystick in any direction to stop the tour or auto pan.

11

Creating Titles

The AutoDome Easy is designed to display a user defined title for individual preset locations, preset tours, and auto pan tours. To insert a title, do the following:

1. Press **ON + 4 + 6 + ENTER** to access the main menu.
2. Select **PRESET, TOUR, or AUTO PAN**.
3. Select the appropriate number for the preset, preset tour, or auto pan to be edited.
4. Select the **TITLE: =====** field, twist the joystick. A character is displayed and the cursor starts blinking indicating it is in edit mode.
5. Twist the joystick knob to the right or left to begin scrolling through the characters. Twist the joystick right to go forward or twist the joystick knob left to go backwards.
6. Press the joystick to the right after reaching the desired letter or number. The letter stops blinking. The next sequential character is changed to a blank space, twist the joystick and repeat step 5.
7. When satisfied with the title, select **SAVE AND EXIT**. To exit without saving, select **EXIT W/O SAVE**.

12 Tour Menu

The **Tour** menu provides access to preset tours that are customized to run a sequence of user selected presets.

MAIN MENU PRESET TOUR AUTO PAN SECTOR ALARM CAMERA SETUP DOME SETUP EXIT	TOUR MENU TOUR: 1 TITLE: ===== DWELL TIME: 05 SEC 01 03 05 = = = = = = = = = = = = DELETE DATA SAVE AND EXIT EXIT W/O SAVE
---	--

Menu	Description
Tour	Accesses a sequence of preset shots combined to provide a pre-programmed tour of the area covered by an AutoDome Easy camera.
Title	Controls a 10-character scene name which is displayed when the AutoDome Easy runs the preset tour (must be user defined via the Title OSD).
Dwell Time	Allows a range of 5-99 sec. The camera pauses at each preset for the specified amount of time. Default is 5.
01 03 05 = = = = = = = = = = = =	Controls a customized sequence of preset shots which are combined to provide a pre-programmed tour of the area covered by an AutoDome Easy camera.
Delete Data	Deletes the previously saved tour.
Save and Exit	Saves the data and exits the menu.
Exit W/O Save	Exits the menu without saving the data.

12.1 Setting a Tour

The AutoDome Easy is designed to set up to four (4) customized sequences of preset shots covered by the AutoDome Easy camera. To set a tour, do the following:

1. Press **ON + 4 + 6 + ENTER** to access the main menu.
2. Select **TOUR**.
3. Select desired tour number (1-4).
4. To edit the title see Section 11: *Creating Titles*.
5. Select the **DWELL TIME** field.
6. Press the joystick right to increase the time or left to decrease the time.
7. Select the **=====** field, to set the sequence of preset shots. Twist the joystick knob. A number is displayed and the cursor starts blinking indicating it is in edit mode.
8. Twist the joystick to the right or left to begin scrolling through the saved presets. Twist the joystick right to go forward or twist the joystick left to go backwards.
9. Press the joystick to the right after reaching the desired number. The number stops blinking. The next sequential number is changed to blinking = =, twist the joystick and repeat step 8.
10. When satisfied with the preset tour, select **SAVE AND EXIT**. To exit without saving, select **EXIT W/O SAVE**.

12.2 Running / Stopping a Tour

The AutoDome Easy is designed to display a customized sequence of preset shots covered by the AutoDome Easy camera. To run a tour, do the following:

1. Press **SHOT + 2 + 0 + (pre-defined tour #) + ENTER**.
For example, to run tour **3**, press **SHOT + 2 + 0 + 3 + ENTER**.
2. To stop a tour, move the joystick in any direction.



NOTICE! A shortcut is available for tour 1. Press **ON + 8 + ENTER**.

13 Auto Pan Menu

The **Auto Pan** function is designed to pan continuously between right and left limit settings. This menu provides access to the starting point, ending point, tilt and zoom, and a customized title feature.

MAIN MENU PRESET TOUR AUTO PAN SECTOR ALARM CAMERA SETUP DOME SETUP EXIT	AUTO PAN MENU AUTO PAN: 1 TITLE: ===== START POINT: 017.0 TILT AND ZOOM 002.6 END POINT: 176.9 SAVE AND EXIT EXIT W/O SAVE
---	---

Menu	Description
Auto Pan	Accesses a range of 1-4 for customized auto pan tours.
Title	Controls a 10-character scene name which is displayed when the AutoDome Easy runs the auto pan tour (must be user defined via the Title OSD).
Start Point	Sets the left pan limit to start panning.
Tilt and Zoom	Controls the camera movement in the vertical direction and the changing of the effective focal length to allow different fields of view to fill the picture area. Zoom can be optical, where the lens is adjusted, or digital, where a portion of the view selected is magnified electronically.
End Point	Sets the right limit to stop panning.
Save and Exit	Saves the data and exits the menu.
Exit W/O Save	Exits the menu without saving the data.

13.1 Set Auto Scans

1. Press **ON + 4 + 6 + ENTER** to access the main menu.
2. Select **AUTO PAN**.
3. Select **AUTO PAN** and select the pan number (1-4).
4. To edit the title see Section 11: *Creating Titles*.
5. Select **START POINT**.
6. Press **ON + 5 + ENTER** to gain access of the **CONTROL**. When finished selecting the camera's starting point, press **OFF + 5 + ENTER**.
7. Select **TILT AND ZOOM**.
8. Press **ON + 5 + ENTER** to gain access of the **CONTROL**. When finished selecting the camera's tilt and zoom, press **OFF + 5 + ENTER**.
9. Select **END POINT**.

10. Press **ON + 5 + ENTER** to gain access of the CONTROL. When finished selecting the camera's end point, press **OFF + 5 + ENTER**.
11. When satisfied, select **SAVE AND EXIT**. To exit without saving, select **EXIT W/O SAVE**.

13.2 Run Auto Pan

The AutoDome Easy is designed to display a customized auto pan between limits. To run the auto pan feature, do the following:

1. Exit the OSD menu.
2. Press **Shot + 3 + 0 + (Auto Pan number) + ENTER**. For example, to run the auto scan for course 4, press **Shot + 3 + 0 + 4 + ENTER**. Note: This is invalid if in menu mode.



NOTICE! Two shortcuts are available for auto pan.

Press **ON + 1 + ENTER** to activate a continuous pan from 0 to 360 degrees starting at the current tilt and zoom positions.

Press **ON + 2 + ENTER** to activate auto pan 1.

14 Sector Menu

The sector function provides access to customizing individual sectors and titles. The factory default is eight (8) evenly spaced sectors with titles from SECTOR1 to SECTOR8.

MAIN MENU PRESET TOUR AUTO PAN SECTOR ALARM CAMERA SETUP DOME SETUP EXIT	SECTOR MENU SECTOR: 1 TITLE: ===== START POINT: 017.0 END POINT: 176.9 DELETE DATA SAVE AND EXIT EXIT W/O SAVE
---	---

Menu	Description
Sector	Accesses a range of 1-8 for customized sectors.
Title	Controls a 10-character scene name which is displayed when the AutoDome Easy pans in any direction (must be user defined via the Title OSD).
Start Point	Sets the left pan limit to display the sector title.
End Point	Sets the right limit to display the sector title.
Delete Data	Deletes the previously saved sectors.
Save and Exit	Saves the data and exits the menu.
Exit W/O Save	Exits the menu without saving the data.



NOTICE! Sector titles are displayed any time the camera moves and disappears three (3) seconds after the camera stops.

15 Alarm Menu

The **Alarm** menu provides access to edit the alarm options.

MAIN MENU PRESET TOUR AUTO PAN SECTOR ALARM CAMERA SETUP DOME SETUP EXIT	ALARM MENU INPUT: NO OPTION: MOMENTARY PRESET: 05 DWELL TIME SAVE AND EXIT EXIT W/O SAVE
---	--

Menu	Description	Options	Default
Input	Defines the type of physical input.	NC - Normally Closed NO - Normally Open OFF - Alarm input is disregarded	OFF
Option	Defines the mode of operation.	Time Out - Upon alarm activation, the camera moves to the defined preset and remains in alarm for the specified dwell time. When the time has expired the camera reverts back to the previous operation prior to the alarm being activated. Momentary - Upon alarm activation, the camera moves to the pre-defined preset position and remains in alarm mode until OFF + 65 + ENTER is pressed. After the alarm is acknowledged, the camera reverts back to the previous operation prior to the alarm being activated.	Time Out
Preset	Moves to the defined preset, upon alarm activation,	All saved presets are available.	1
Dwell Time	In time out mode, the camera remains in alarm mode for the specified dwell time.	Allows a range of 5-99 sec.	5
Save and Exit	Saves and exits the menu.		
Exit W/O Save	Exits the menu without saving the data.		

15.1 Releasing an Alarm

There are two modes of operation. Time out releases the alarm after the dwell time. However, time out may also be released by pressing **OFF + 6 + 5 + ENTER**. Momentary can only be released with the following sequence: press **OFF + 6 + 5 + ENTER**.

16 Camera Setup Menu

The **Camera Setup** menu provides access to lens settings that can be changed or customized.

MAIN MENU PRESET TOUR AUTO PAN SECTOR ALARM CAMERA SETUP DOME SETUP EXIT	CAMERA SETUP MENU FOCUS CONTROL WB CONTROL AE CONTROL L/L CONTROL PICTURE INITIALIZE CAMERA EXIT W/O SAVE
---	--

Menu	Description
Focus Control	Controls the focus mode and digital zoom.
WB Control	Controls the white balance mode.
AE Control	Controls the auto exposure options.
L/L Control	Controls access between changing line lock and crystal mode.
Picture	Controls the mirror and sharpness settings.
Initialize Camera	Resets to the default settings for the camera setup menu only.
Exit W/O Save	Exits the menu without saving the data.

16.1 Focus Control Menu

The **Focus Control** menu provides access for mode, focal distance, and digital zoom.

CAMERA SETUP MENU FOCUS CONTROL WB CONTROL AE CONTROL L/L CONTROL PICTURE INITIALIZE CAMERA EXIT	FOCUS CONTROL MENU MODE: MANUAL DISTANCE: 0.1M DIGITAL ZOOM: OFF SAVE AND EXIT EXIT W/O SAVE
--	---

Menu	Description	Options	Default
Mode	Selects either manual or auto focus control.	Manual - Controls the focus using the keyboard buttons. Auto - Automatically focuses the camera as the camera is moved.	Manual
Distance	Limits the focus range of the camera. The camera will not focus on any object within the specified limit.	Allows a range of 0.1, 1.0, 1.5, 2.5, 6.0 m.	0.1 m
Digital Zoom	Activates the digital imaging technology to increase the range beyond the optical zoom.	ON - Provides an additional 10x digital zoom. OFF - Turns off digital zoom.	OFF
Save and Exit	Saves the data and exits the menu.		
Exit W/O Save	Exits the menu without saving the data.		

16.2 WB Control Menu

The **WB Control** menu provides access to the white balance modes which includes auto, indoor, outdoor, and manual.

CAMERA SETUP MENU FOCUS CONTROL WB CONTROL AE CONTROL L/L CONTROL PICTURE INITIALIZE CAMERA EXIT	WB CONTROL MENU MODE: AUTO R-GAIN: B-GAIN: SAVE AND EXIT EXIT W/O SAVE
--	---

Menu	Description	Options	Default
Mode	Maintains proper color reproduction as the color temperature of a scene changes. For example, from daylight to fluorescent lighting.	Indoor - Optimizes camera color for typical indoor conditions. Outdoor - Optimizes camera color for typical outdoor conditions. Manual - Manually adjusts the camera's output color independent of the lighting used. Auto - Automatically adjusts the output color to display a natural color independent of the lighting used.	Auto
R-Gain	Adjusts the red gain to optimize the white point. Available in manual mode only.	Allows a range of 0-255.	*
B-Gain	Adjusts the blue gain to optimize the white point. Available in manual mode only.	Allows a range of 0-255.	*
Save and Exit	Saves the data and exits the menu.		
Exit W/O Save	Exits the menu without saving the data.		

*Automatically adjusts the camera to the current light level, when in manual mode.

16.3 AE Control Menu

The **AE Control** menu provides access to auto exposure options which includes modes, iris, gain, shutter, and brightness.

CAMERA SETUP MENU FOCUS CONTROL WB CONTROL AE CONTROL L/L CONTROL PICTURE INITIALIZE CAMERA EXIT	AE CONTROL MENU MODE: AUTO IRIS: GAIN: SHUTTER: BRIGHT: 30 BACK LIGHT: OFF SAVE AND EXIT EXIT W/O SAVE
--	--

Menu	Description	Options	Default
Mode	Provides gain control modes.	Auto - The camera automatically adjusts iris, gain, and shutter speeds. Brightness may be pre-defined. Shutter PRI - The camera automatically adjusts iris and gain. The shutter and brightness may be pre-defined. Iris PRI - The camera automatically adjusts the gain and shutter. The iris and brightness may be pre-defined. Manual - The camera operates in the manual mode. The iris, gain, and shutter must be pre-defined. Flickerless - The camera automatically removes flicker, when camera signal format does not coincide with the power source frequency. For example, when an NTSC camera is used with 50 Hz power.	AUTO
Iris	Controls the lens's F stop value to manually adjust for various light levels. Available with iris PRI and manual mode only.	F1.8, 2, 2.4, 2.8, 3.4, 4, 5.6, 6.8, 8, 9.6, 11, 14, 16, 19, 22, CLOSE	F2.8
Gain	Electronics that regulate the gain or amplification of the video signal. Available in manual mode only.	Allows a range of 0-30.	0
Shutter	Manually adjusts the shutter speed. Available in shutter PRI and manual mode only.	NORMAL (60 NTSC and 50 PAL), 100, 120, 250, 500, 1000, 2000, 5000, 10000	100
Bright	Reduces the camera's iris level for proper exposure.	Allows a range of 0-90.	30

Menu	Description	Options	Default
Back Light	Selectively amplifies parts of the image to compensate for large contrast differences when only a portion of the image is brightly lit (e.g. a person in a sunlit doorway).	ON, OFF	OFF
Save and Exit	Saves the data and exits the menu.		
Exit W/O Save	Exits the menu.		

Mode	Iris	Gain	Shutter	Brightness	Back Light
Auto				●	●
Shutter PRI			●	●	●
Iris PRI	●			●	●
Manual	●	●	●		●

Table 16.1 Mode Options

16.4 L/L Control Menu

The L/L Control menu provides access to the sync mode which includes external and internal.

```
CAMERA SETUP MENU
FOCUS CONTROL
WB CONTROL
AE CONTROL
L/L CONTROL
PICTURE
INITIALIZE CAMERA
EXIT
```

```
L/L CONTROL MENU
MODE: INTERNAL
PHASE:
SAVE AND EXIT
EXIT W/O SAVE
```

Menu	Description	Options	Default
Mode	Selects the sync mode.	Internal - Synchronizes camera to an internal crystal. This choice is recommended if there is noise on the power line. External - Synchronizes camera to AC power. This choice eliminates picture roll in multi-camera systems.	Internal
Phase	Optimizes the line lock mode to eliminate picture roll in multiphase power applications.	Allows a range 0-620 (PAL). Allows a range 0-519 (NTSC).	Automatically adjusts to the AC power line.
Save and Exit	Saves the data and exits the menu.		
Exit W/O Save	Exits the menu without saving the data.		

16.5 Picture Menu

The **Picture** menu provides access to miscellaneous video settings which includes mirror and sharpness.

CAMERA SETUP MENU FOCUS CONTROL WB CONTROL AE CONTROL L/L CONTROL PICTURE INITIALIZE CAMERA EXIT	PICTURE MENU MIRROR: OFF SHARPNESS: 09 SAVE AND EXIT EXIT W/O SAVE
--	--

Menu	Description	Options	Default
Mirror	Selects a mirror image.	ON, OFF	OFF
Sharpness	Adjusts the sharpness of the picture.	Allows a range of 0-15.	8
Save and Exit	Saves the data and exits the menu.		
Exit W/O Save	Exits the menu without saving the data.		

16.6 Initialize Camera Menu

The **Initialize Camera** menu allows you to reset all camera settings to the default setting. Press the joystick to the right to display the following message: CAMERA WILL BE INITIALIZED!! ARE YOU SURE?

CAMERA SETUP MENU FOCUS CONTROL WB CONTROL AE CONTROL L/L CONTROL PICTURE INITIALIZE CAMERA EXIT	CAMERA WILL BE INITIALIZED!! ARE YOU SURE? NO YES
--	--

17 Dome Setup Menu

The **Dome Setup** menu provides access to miscellaneous camera parameters which includes: language, OSD, auto pivot, home function, initialization, and dome information.

MAIN MENU PRESET TOUR AUTO PAN ALARM CAMERA SETUP DOMES SETUP EXIT	DOME SETUP MENU LANGUAGE: ENGLISH OSD DISPLAY: OFF AUTO PIVOT: ON HOME FUNCTION INITIALIZE DOME DOME INFORMATION SAVE AND EXIT EXIT W/O SAVE
--	--

Menu	Description	Options	Default
Language	Selects the language for the OSD menu.	English, Espanol, and Francais	English
OSD Display	Controls the information displayed by the OSD.	ON - Displays the dome address, sector title, and the camera position data. OFF - Displays sector titles only.	OFF
Auto Pivot	Automatically turns the AutoDome Easy camera 180 degrees when the camera tilts to its lowest position. When the camera vertically reaches 90 degrees, it stops. Release the joystick, then press down to activate the flip function.	ON, OFF	ON
Home Function	Selects the mode that the camera reverts to after a period of inactivity to the defined dwell time.		
Initialize Dome	Resets to the default settings for all menus.	YES, NO	N/A
Dome Information	Displays the firmware version number.		
Save and Exit	Saves the data and exits the menu.		
Exit W/O Save	Exits the menu without saving the data.		

17.1 Home Function

The **Home Function** menu can be set so that the camera automatically goes to preset, tour, or auto pan after the keyboard controller has been in idle for a specified amount of time. For example, if the joystick controller has not been used for 10 seconds, the camera goes to preset 1.

DOME SETUP MENU LANGUAGE: ENGLISH OSD DISPLAY: OFF AUTO PIVOT: ON HOME FUNCTION INITIALIZE DOME DOME INFORMATION SAVE AND EXIT EXIT W/O SAVE	HOME FUNCTION MENU MODE: OFF FUNCTION TYPE: FUNCTION NUMBER: DWELL TIME: SAVE AND EXIT EXIT W/O SAVE
---	--

Menu	Description	Options	Default
Mode	Disables/enables the homing function.	ON, OFF	OFF
Function Type	Reverts to the defined mode of operation.	Tour - Access a sequence of preset shots combined to provide a pre-programmed tour of the area covered by an AutoDome Easy camera. Auto Pan - Customizes auto pan tours. Preset - Pre-selects and stores a combination of pan, tilt and zoom positions which allow a set view to be recalled. Also known as preset shot.	Preset
Function Number	Represents the tour, auto pan, or presets which have been saved.	Tour - Allows a range of 1-4. Auto Pan - Allows a range of 1-4. Preset - Allows a range of 1-60.	1
Dwell Time	Indicates the period of time the keyboard controller has been in idle before activating the homing function.	Allows a range of 5-600 sec.	5 sec.
Save and Exit	Saves the data and exits the menu.		
Exit W/O Save	Exits the menu without saving the data.		

17.2 Initialize Dome Menu

The **Initialize Dome** menu resets all menus to the factory default settings. Press the joystick to the right to display the following message: ALL DATA WILL BE DELETED!! ARE YOU SURE?

```
DOME SETUP MENU
LANGUAGE: ENGLISH
OSD DISPLAY: OFF
AUTO PIVOT: ON
HOME FUNCTION
INITIALIZE DOME
DOME INFORMATION
SAVE AND EXIT
EXIT W/O SAVE
```

```
ALL DATA WILL BE DELETED!!
ARE YOU SURE?
NO
YES
```

17.3 Dome Information Menu

The **Dome Information** menu displays the firmware version.

```
DOME SETUP MENU
LANGUAGE: ENGLISH
OSD DISPLAY: OFF
AUTO PIVOT: ON
HOME FUNCTION
INITIALIZE DOME
DOME INFORMATION
SAVE AND EXIT
EXIT W/O SAVE
```

```
DOME INFORMATION
VERSION: 2.0.0
EXIT
```

18 Keyboard Commands by Number

Function Key	Comm No.	Command	Description
On/Off	1	Scan 360 degrees	Autopans from 0-360 degrees.
On/Off	2	Activates autopan 1	Autopan between defined limits.
On/Off	8	Play pre-position Tour 1	Activate/deactivate.
Off	65	Alarm acknowledge	Acknowledge alarm or deactivate physical outputs.
On	66	Displays firmware version	Displays firmware version number.
Set	"1-60"	Pre-position programming	Set ##—programs a preset view.
Shot	"1-60"	Pre-position recall	Shot ##—recall programmed preset.
Set	110	Factory P/T home position	Set—recalibrate home position.
Shot	"201-204"	Run tour	Activates preset tour 1-4.
Shot	"301-304"	Run auto pan	Activates auto pan 1-4.

19 Troubleshooting

If you experience difficulties operating your AutoDome Easy camera, refer to the following. If the guidelines do not enable you to solve the problem, contact an authorized technician.

Problem	Check
Nothing appears on the screen.	Are the power cord and line connection between the camera and monitor made properly?
The image on the screen is dim.	Is the lens dirty? If so, clean the lens with a soft, clean cloth.
The contrast on the screen is too weak.	Adjust the contrast feature of the monitor. Is the camera exposed to strong light? If so, change the camera position.
The image on the screen is flickers.	Does the camera face directly into the sun or fluorescent lighting? If so, reposition camera.
The image on the screen is distorted.	Is the power frequency set properly in sync? If the power frequency is not set correctly, the line lock synchronization mode cannot be used. Set the synchronization mode to INT.NTSC Model power frequency in LL mode: 60 Hz.

20 Preventive Maintenance

The following the preventive maintenance schedule allows detection and correction of minor faults before they become serious and cause equipment failure. Periodically perform the following:

- Inspect all connecting cables for deterioration or other damage.
- Wipe housing with a clean damp cloth. Clean P.C (LEXAN) dome/windows with an approved P.C (LEXAN) Cleaner (Novus LEXAN cleaner-plastic polish).
- Verify that all the mounting hardware is secure.

21 Spare Parts List

Command	Description
9965 300 00640	Covert liner
9965 300 00643	Wire harness assembly
9965 300 00644 Black 9965 300 00645 White	Bubble assembly with screws
www.boschsecurity.com	User manual
9965 300 00648	Accessory kit
9965 300 00649	Bubble tether
9965 300 00650	Screws for bubble tether
9965 300 00651	Mounting plate
9965 300 00652	Bubble screws torx lock
9965 300 00653	O-ring for bubble screws

Americas:

Bosch Security Systems
130 Perinton Parkway
Fairport, New York, 14450
USA
Phone +1 800 289 0096
Fax +1 585 223 9180
www.boschsecurity.us

Europe, Middle East, Asia:

Bosch Security Systems B.V.
Postbus 80002
5600 JB Eindhoven
Phone: +31 40 2577 200
Fax: +31 40 2577 202
nl.securitysystems@bosch.com
www.boschsecurity.nl
www.boschsecurity.com

www.boschsecurity.com**Asia-Pacific:**

Bosch Security Systems Pte Ltd.
38C Jalan Pemimpin
Singapore 577180
Phone +65 6319 3450
Fax +65 63139 3499
www.boschsecurity.com