

MegaPixel Network Camera

KNC-Xi210HD Installation Guide



Table of Contents

1. INTRODUCTION
2. PACKAGE CONTENTS
3. PRODUCT DESCRIPTION
4. INSTALL THE HARDWARE
5. ASSIGN AN IP ADDRESS
6. TERMINAL BLOCK CONNECTORS

1. Introduction

KNC-Xi210HD Installation Guide

This installation guide provides instructions for installing the Network Camera on your network. For all other aspects of using the product, please see the User's Manual, available on the CD included in this package, or from <http://www.ktnc.co.kr>



Installation steps

1. Check the package contents against the list below.
2. Product description
3. Install the hardware
4. Set an IP address
5. Set the admin and user ID and password, See User's Manual. instructions in further usage.

Important!

This product must be used in compliance with local laws and regulations.

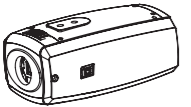
2. Package Contents

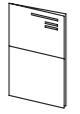
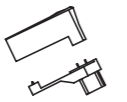
| | | |
|---|---|---|
|  |  |  |
| KNC-Xi210HD | C-Mount Adaptor ring | Software CD |
|  |  | |
| Installation Guide | Auto Iris Lens Connection Plug | |

3. Product Description

Description and function

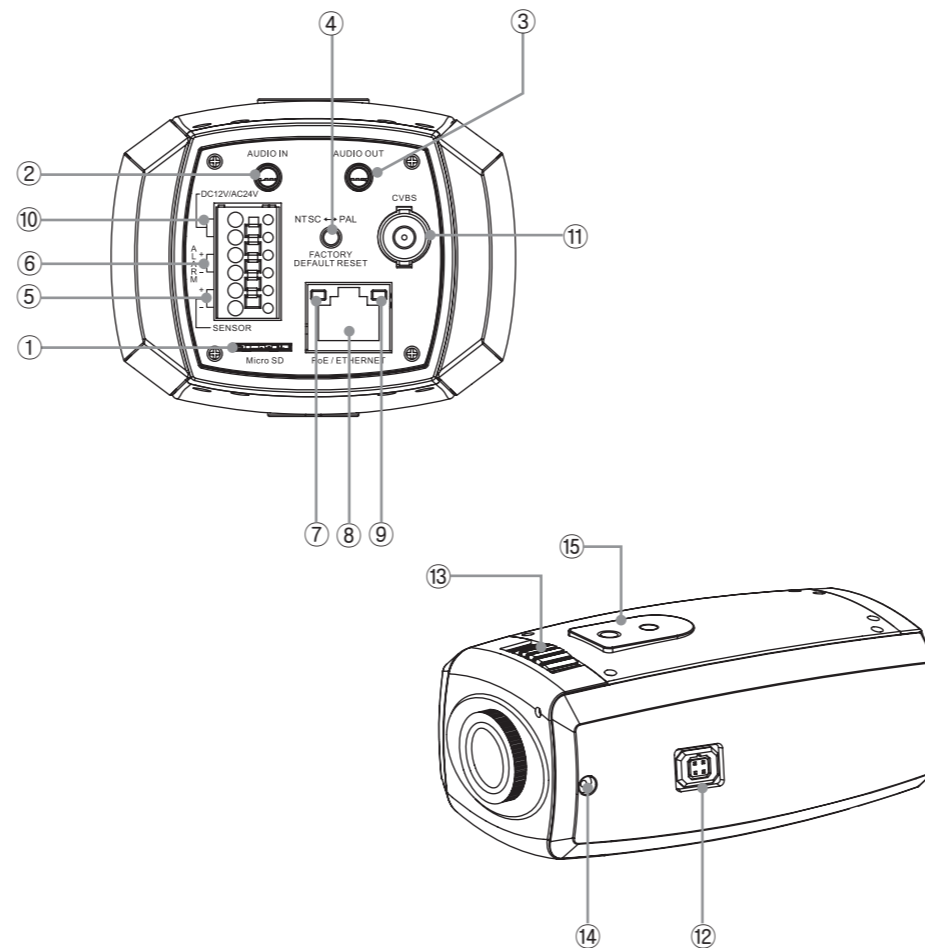

1. **Micro SD/SDHC Memory Slot** – Insert Micro SD or Micro SDHC memory card for recording videos and saving images.
 2. **Line / MIC In** – Connect 3.5mm jack from line level audio source or MIC.
 3. **Line Out** – Connect 3.5mm jack from speaker.
 4. **Reset Switch/NTSC or PAL select** – Push and hold the reset button for more than 10 second to reset the Network Camera. Push this switch to use analog video of NTSC or PAL format on installing.
 5. **Digital Input** – Connect signal from external sensor.
- CAUTION: This feature will reset all settings to the original factory default settings.**
- CAUTION: This button has two functions(factory default settings or selecting analog video).**
6. **Digital Output** – Connect signal to external alarm. (Max. current - DC 12V, 40mA)
 7. **Network LED** – Network LED indicates network connection status.
 8. **Network Connector** – The Network Camera connects to the network via a standard network cable, and automatically detects the speed of the local network segment (10BaseT/100BaseTX Ethernet).PoE Supported.
 9. **Status LED** – Status LED indicates the Network Camera operation status.
 10. **Power Input(DC12V/AC24V)** – Connect DC 12V or AC 24V power.
 11. **Service Video Connector** – For checking the view of the camera on a portable monitor when the camera is being installed.
- CAUTION : The analog video can be viewed only in 1280x1024 resolution.**
12. **Auto Iris Jack** – Connect DC Iris cable.
 13. **Back Focus Adjustment Level** – Use to adjust focus.
 14. **Focus Fixing Screw** – Use to fix back focus adjustment level.
 15. **Tripod Mounting Hole** – Use to connect standing bracket.

4. Install the hardware

KNC-Xi210HD is designed to be installed using standing bracket on the wall or ceiling.

Lens connection

Lens are sold separately. Lenses such as an auto iris lens, CS-Mount and C-Mount lens can be used.

Note:

- It is recommended that megapixel lens are used to optimize performance.
- Please keep the lens clean.
- Any foreign objects and finger marks on the lens can cause inferior image quality in low light level conditions

When using an auto iris lens

1. Please peel off about 8mm of the outer skin of the auto iris lens cable.

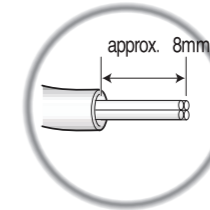

2. Please peel off about 2mm of the outer skin of the insulated conductor inside the lens cable.

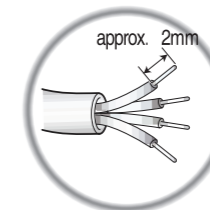

3. Please remove the cover of the auto iris connection plug and solder the lens cable to the connector pin in plug.

* PIN ASSIGNMENT OF THE LENS CONNECTOR

- DC auto iris lens
 Pin 1 : DAMP-(CTL-)
 Pin 2 : DAMP+(CTL+)
 Pin 3 : DRV+
 Pin 4 : DRV-(GND)

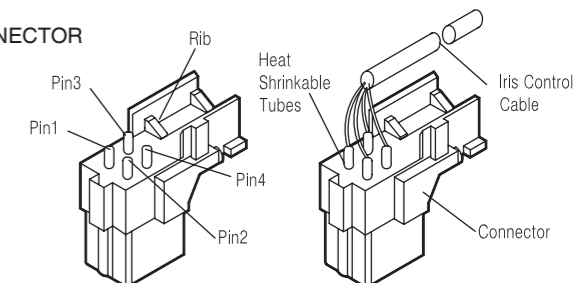

4. Please replace the auto iris lens connection plug cover and take off the CIS protection cap and then attach the auto iris to the camera by Screwing it in clockwise.
5. Please insert the connection plug that is connected to the auto iris lens Cable into the auto lens connector, which is located on the side of the Camera.

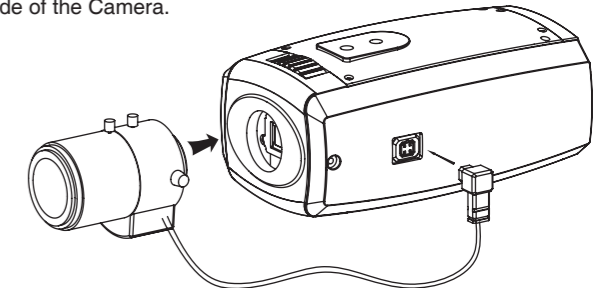

Installation of C-Mount Lens

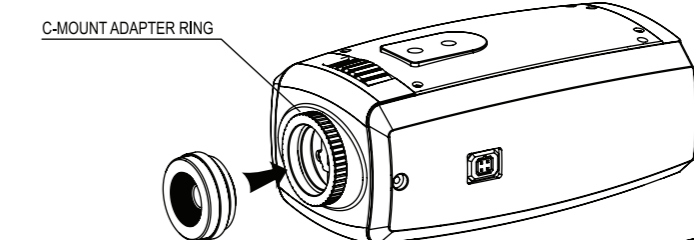

Installation of CS-Mount Lens

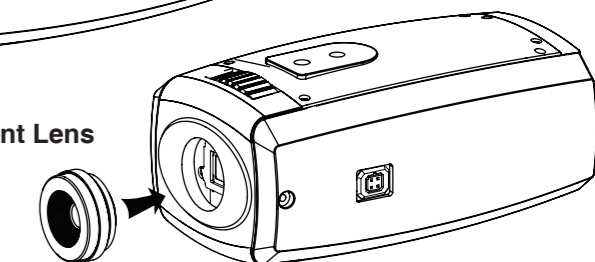

How to connect video and audio

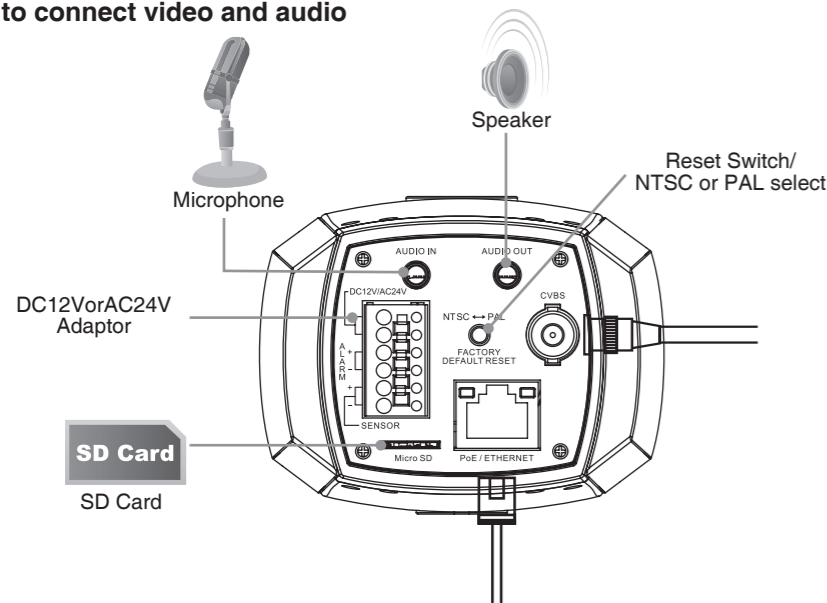

1. Optionally connect a microphone or line in mono signal to the Line in/MIC connector.
2. Optionally connect a speaker to Line out connector.
3. Optionally insert a Micro SD card to Micro SD socket.
4. Connect the camera to the network using a UTP cable (CAT.5), Power can be supplied via the network cable (PoE)
5. Connect DC 12V or AC 24V to the power terminal. This is not necessary if the Network Camera is connected to PoE hub or midspan. Caution: Do not apply DC 12V and AC 24V at the same time.
6. Check that the indicator LEDs indicates the correct conditions.
7. Connect the analog monitor to the service video connector for adjusting focus and press and quickly release the reset switch for focus assistant mode. Then you can select normal view or focus view mode using the reset switch.

CAUTION: Do not apply DC 12V and AC 24V at the same time.

6. Check that the indicator LEDs indicates the correct conditions.

7. Connect the analog monitor to the service video connector for adjusting focus and press and quickly release the reset switch for focus assistant mode. Then you can select normal view or focus view mode using the reset switch.

CAUTION: When you use focus assistant mode, "Focus View" mode is recommended for more exact focus.

CAUTION: Focus assistant mode will be automatically exited after 3 minutes for normal operation.

5. Assign an IP address

To make it accessible on the network, the Network Camera must be assigned an IP address.

Note:

- A network DHCP server is optional.
- The Network Camera has the default IP address 192.168.0.123.
- If IP assignment fails, check that there is no firewall blocking its operation and check that the Network Camera and your computer's IP is located on the same subnet.

Assign an IP address using IP Installer

IP installer automatically search and display KT&C network devices on your network. The application can also be used to manually assign a static IP address.

Note:

The computer running the IP installer must be on the same network segment (physical subnet) as the Network Camera.

1. Check that the Network Camera is connected to the network and that power has been applied.

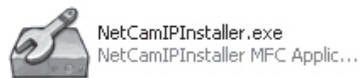

2. Start KT&C IP installer.

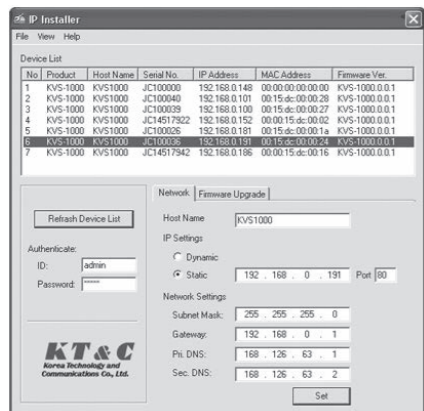

3. When the Network Camera appears in the window, select the Network Camera which needs to assign the IP address.
 - A. Refresh Device List – Rescan local network to find the Network Camera.
 - B. Authenticate – Enter the administrator ID and password.
 - C. Host Name – Enter the Host Name of the Network Camera.
 - D. IP Settings
 - i. Dynamic – Assign dynamic IP address automatically from DHCP server on your network.
 - ii. Static – Assign static IP address manually.
 - iii. Port – Enter the HTTP port the Network Camera will use. The default setting is 80. Alternatively, any port in the range 1024-65535 may be used, but check first with your system administrator before changing the default setting.
 - E. Network Settings
 - i. Subnet Mask – Specify the mask for the subnet the Network Camera located on.
 - ii. Gateway – Specify the IP address of the default router (gateway) used for connecting devices attached to different networks and network segments.
 - iii. Pri. DNS – Enter the IP address of the primary DNS server. This server provides the translation of host names to IP addresses on your network.
 - iv. Sec. DNS – Specify the IP address of the secondary DNS server. This will be used if the primary DNS server is unavailable.

4. Click "Set" button to save configuration.

Accessing the Network Camera

1. Start your browser.
2. Enter the IP address or host name of the Network Camera in the Address field of your browser.

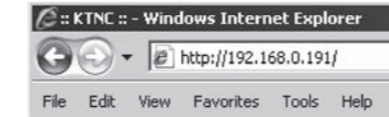

3. If you are accessing the Network Camera for the first time, you will see the following warning message as shown below.



4. Click the warning message and select "Install ActiveX Control...".



5. Click "Install" to install the KT&C Web Viewer.



6. If a Windows Security Alert pop-up appears, click "Unblock".

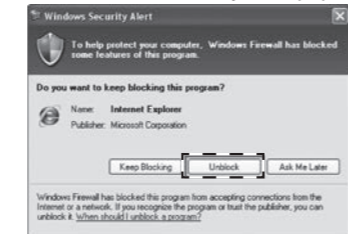

7. After installing the KT&C Web View ActiveX Control, a Login page will be displayed. Enter the user ID and password.

Note:
Default User ID and Password is [ID: admin, Password: admin]



8. The video image displays in your browser.



Note:
To view streaming video in Microsoft Internet Explorer, you must set your browser to allow the "KT&C Web Viewer" to be installed on your computer. This ActiveX component is installed the first time a video stream is accessed.

6. Terminal Block Connectors

KNC-Xi210HD is connected with external equipment as following diagram below.

Circuit diagram

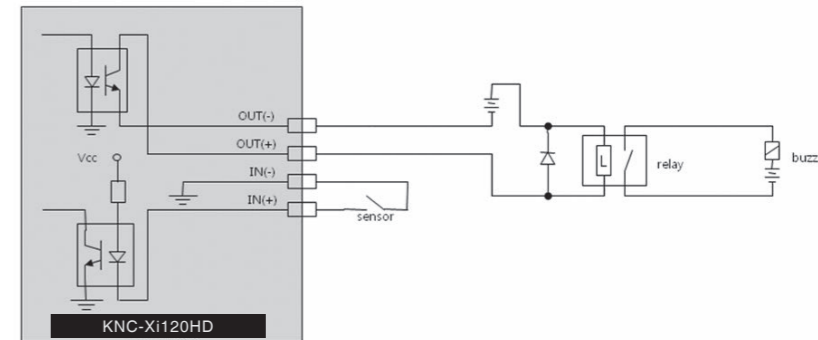

1. INPUT – Connect the external sensor e.g. PIR motion sensor. (3.3V DC pull-up built in)
 - A. ON - Short-circuit with GND.
 - B. OFF - Open

CAUTION : Digital Input must not be exposed to voltages greater than 10V DC.

2. OUT – Connect the external alarm e.g. light or buzzer.

CAUTION : If used with an external relay, a diode must be connected in parallel with the load, for protection against voltage transients.

CAUTION : Max. load = 70mA Max voltage = 12V DC.

Example of terminal connection

