

AKAI

USER'S MANUAL

Multifunction 7" TFT LCD monitor

EPV6707X

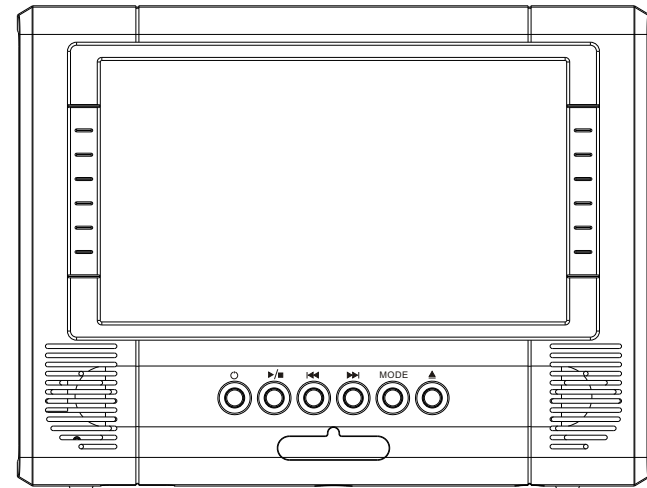

Importer AKAI Benelux Elmarc B.V.
Information : www.akai.nl



Please read these instructions completely before operating.

WARNING

Thank you for purchasing this multifunction DVD player. Please read this manual carefully before operating your player and keep it handy for future reference. It will be helpful to you if you encounter any operational problem.

WARNING: To reduce the risk of fire or electric shock, do not expose this appliance to rain or moisture. Dangerous high voltages are present inside the enclosure. Do not open the cabinet. Refer servicing to qualified personnel only.

ATTENTION: To prevent electric shock, match wide blade of plug to wide slot, and fully insert.

LASER: This Digital Versatile Disc Player employs a Laser System. To ensure proper use of this product, please read this owner's manual carefully and retain for future reference. Should the unit require maintenance, contact an authorized service location. See service procedure.

Use of controls, adjustments or the performance of procedures other than those specified may result in hazardous radiation exposure.

To prevent direct exposure to laser beam, do not try to open the enclosure.

Visible and invisible laser radiation when open and interlocks defeated.

DO NOT STARE INTO BEAM

LASER

Type: Semiconductor laser GaAIAs
Wave length: 650 nm/780nm
Output Power: 5 mW
Beam divergence: 60 degree

WARNING:

To reduce the risk of fire or electric shock, do not expose this appliance to rain or moisture.

CAUTION:

Use of controls or adjustments or performance of procedures other than those specified may result in hazardous radiation exposure.

CAUTION

RISK OF ELECTRIC SHOCK. DO NOT OPEN!

To reduce the risk of electric shock, do not remove cover (or back). No user serviceable parts are inside. Refer servicing to qualified service personnel.

MACROVISION

NOTICE:

This product incorporates copyright protection technology that is protected by method claims of certain U.S. patents and other intellectual property rights owned by Macrovision Corporation and other rights owners. Use of this copyright protection technology must be authorized by Macrovision Corporation, and is intended for home and other limited viewing uses only unless otherwise authorized by Macrovision Corporation. Reverse engineering or disassembly is prohibited. Apparatus Claims of U.S. Patent Nos. 4,631,603; 4,819,098; 4,907,093; 5,315,448 and 6,516,132 licensed for limited viewing uses only.

FCC NOTICE:

This equipment has been tested and found to comply with the limits for a Class B digital device. Pursuant with the FCC Rules, Part 15. These limits are designed to provide reasonable protection against harmful interference in a residential installation.

FCC Caution:

To assure continued compliance, (example-use only shielded interface cables when connecting to computer or peripheral devices) any changes or modifications not expressly approved by the party responsible for compliance could void the user's authority to operate this equipment.

Manufactured under license from Dolby Laboratories.

"Dolby" and the double-D symbol are trademarks of Dolby Laboratories.

WARNING	1-2
Table of Contents	3
Introduction	4
Accessories	5-6
Precautions	7-8
Parts Designation	9-12
Audio/Video Connections	13-15
Using the remote control	16
Caution	17
Basic Operation Procedures of the Player	18-23
USB 1.1 / Card Reader	24
MP3 /JPEG/MPEG4 Operation	25-26
Set Up	27
Troubleshooting.....	28-29
Specifications	30

The DVD video player (With DVD Cartridge) can play discs with the following marks.



DVDs



Mp3 Audio Cds



Structured Audio



Video Cds



Audio Cds

DVDs sold globally are typically encoded to restrict their use to specific locations. That is, a DVD assigned a specific 'Region Code' can only be played within the areas specified in that Region Code.

The DVD Region Code can usually be found on the back of the DVD's package. It is therefore important that you make sure that the DVD(s) you are buying are compatible with your DVD player.



Region 1: USA, Canada, U.S. Territories



Region 2: Japan, Europe, South Africa, Greenland and the Middle East (including Egypt)



Region 3: South East Asia (including Hong Kong, S. Korea and Taiwan)



Region 4: Australia, New Zealand, Pacific Island, Central America, Mexico, South America, and the Caribbean



Region 5: Eastern Europe (Russia and the former Soviet Union), the Indian subcontinent, Africa and Mongolia



Region 6: China



Region 7: Reserved



Region 8: Special international venues (airplanes, cruise ships, etc.)



Region 0 or All Region This designation indicates that the individual DVD can be played worldwide, i.e. in Regions 1 - 6 DVD players. However, PAL discs must be played in a PAL-compatible unit and NTSC discs must be played in an NTSC-compatible unit

Accessories

Before operating the player, please check that the following accessories are supplied with the player:

1. User's manual (this manual)



2. Remote control



3. AV cable

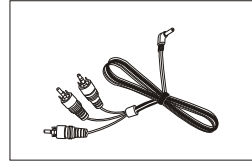

4. Cigarette lighter adapter

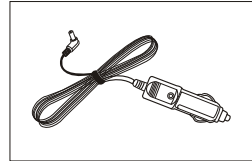

5. AC/DC 12v adapter

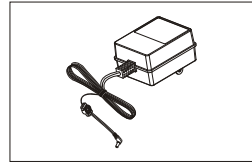

6. 2.5hr Battery

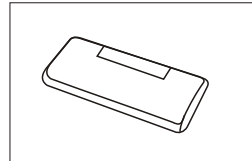

Accessories

7. Headrest mount



8. Carry bag

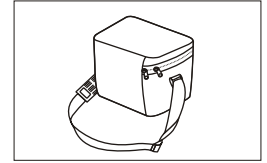

Accessories (OPTIONAL)

1. LCD monitor prop

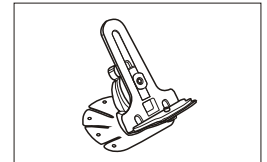

Precautions

1. The laser beam used in this player is harmful to the eyes. Do not attempt to disassemble the player. Refer servicing to qualified personnel only. This Compact Disc player is classified as a **CLASS 1 LASER** product. The **CLASS 1 LASER PRODUCT** label is located on the exterior.

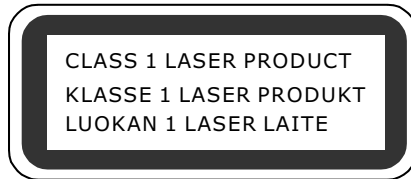

CAUTION



**Invisible laser radiation
when open and interlocks
defeated.**

Avoid exposure to beam.

The shock of impact can damage the player. Install the player where it is flat and will not fall, or be kicked or banged.

2. Should any solid object or liquid fall into the player, disconnect the AC/DC power adapter immediately, and wipe the player with a soft, dry cloth. Never use solvents such as alcohol or benzene.
3. To clean the player, wipe it with a soft, dry cloth. Never use solvents such as alcohol or benzene.
4. If thunder comes or other unusual situation happens, turn off the power and remove the plug from the outlet. Plug in after one minute.
5. In case of electrical shock, inspect the connecting cable. Never use a faulty cable.
6. Keep the original package for returning the player for service if needed.
7. Before moving the player, make sure any disc is removed from the player. Otherwise, the disc and parts of the player could be damaged.

Precautions

■ Installation for the player

1. Avoid locations where the player would be exposed to:

- Excessive dust
- Vibration
- High humidity
- Extreme high or low temperature
- Direct sunlight
- Direct heat from a heat source
- Strong magnetic field

2. Condensation-Moisture may form on the optical pickup lens when:

- The unit is moved from a cold spot to a warm spot.
- The heating system has just been turned on.
- The unit is cooled by an air conditioner.

■ AC/DC Power Adapter

1. Use this player only with the supplied AC/DC power adapter. Using with other AC/DC power adapters could damage the player.
2. Do not touch the AC/DC power adapter with wet hands. Doing so could result in an electrical shock.
3. When the player is not being used for a prolonged period of time, disconnect the AC/DC adapter from a wall outlet.
4. Do not pull the AC/DC adapter out of the wall by the cord, always removed by pulling on the adapter body.

■ Monitor

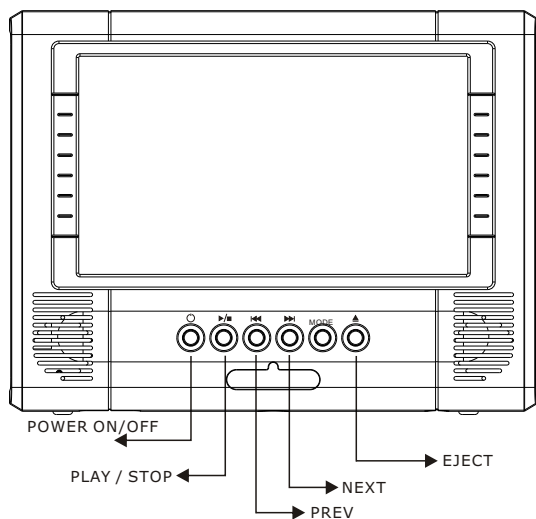

1. POWER ON/OFF: PRESS THE "ON" KEY AND WAIT 3 SEC.

2. POWER STOP: PRESS THE "OFF" KEY AND WAIT 3 SEC.

3. PLAY/STOP: PRESS THE "PLAY" KEY FOR PLAYING.
PRESS THE "STOP" KEY FOR STOP.

4. MODE: PRESS THE "MODE" KEY.
TO SWITCH PLAYER MODE.

EACH PRESS OF THE **MODE** BUTTON WILL CYCLE
THROUGH THE MODES AS FOLLOWS:

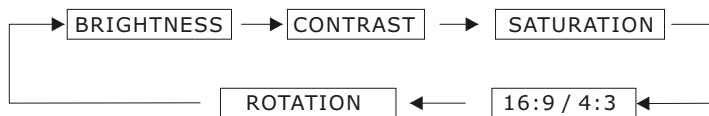

5.◀◀(PREV) AND▶▶(NEXT): THE SETTING VALUE INCREASE /
DECREASE OF SELECTED MENU ITEMS.

■ Left Side

1. USB 1.1
2. Earphone output
3. Volume
4. A/V out jack
5. Coaxial out
6. DC IN

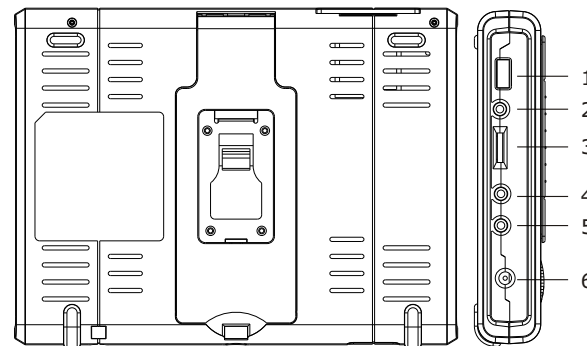

■ Right Side

1. Left & Right speaker
2. Color LCD display
3. Remote control sensor
4. Slot-In DVD Player
5. Card Reader
(SD/MS/MMC/CF Interface)

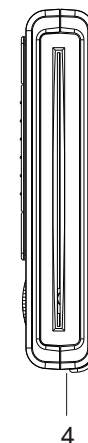
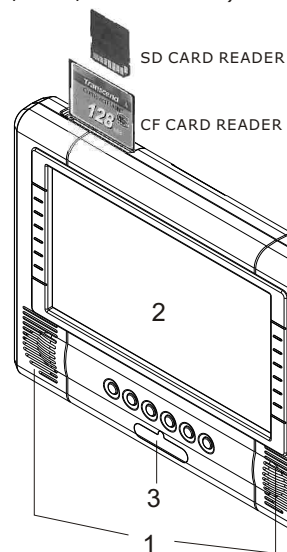
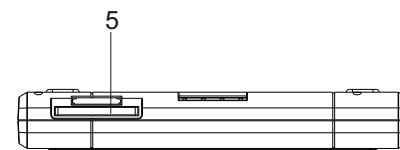

Remote control

The instructions in this page describe the functions on the Remote Control.

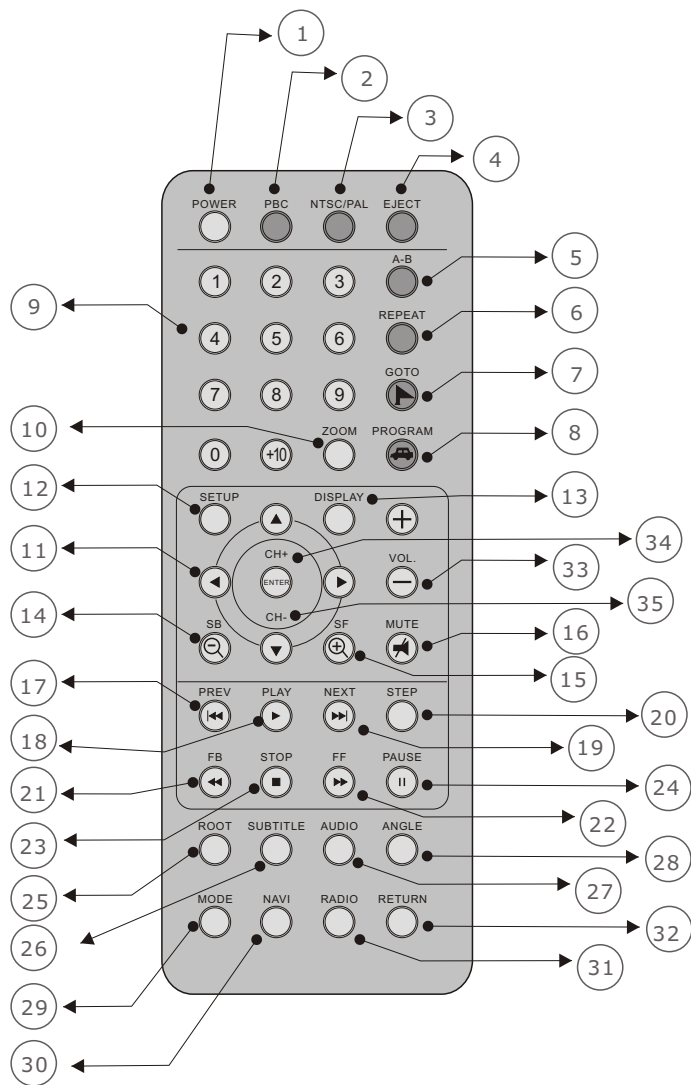

	The button on the remote	
1	POWER	Control the power ON or standby mode.
2	PBC	Playback control for VCD 2.0 format disc.
3	NTSC/PAL	NTSC, and PAL TV mode selection.
4	EJECT	To eject a disc.
5	A-B	Replaying point A to point B when selected.
6	REPEAT	Replaying 1 track or all track of disc.
7	▶ / GOTO	Jump to select chapter/ time. (▶ Keep to mould group GPS)
8	🚗 / PROGRAM	Programming the tracks playing order. (🚗 Keep to mould group GPS)
9	⓪ Ⓛ Ⓜ Ⓝ Ⓟ Ⓠ Ⓡ Ⓢ Ⓣ	Select the desired channel with the number button directly.
10	ZOOM	Enlarge the picture on screen.
11	⬆ ⬇ ⬅ ➡ ⬆	DIRECTION KEYS (UP/DOWN/LEFT/RIGHT/ENTER)
12	SETUP	System setup key.
13	DISPLAY	Using the on-screen display.
14	⏮ / SB	Play video disc backward in slow motion. (⏮ Keep to mould group GPS)
15	⏭ / SF	Play video disc forward in slow motion. (⏭ Keep to mould group GPS)
16	🔇 MUTE	Shut off all audio output.
17	⏪ PREV	Jump to previous track.
18	▶ PLAY	Start playback.
19	⏩ NEXT	Jump to next track.
20	STEP	Forward only plays one picture forward when push button.
21	⏮ FB	Fast backward key. It can choose: VCD: 2X, 4X backward speed. DVD: 2X, 4X, 8X backward speed.
22	⏭ FF	Fast forward key. It can choose: VCD: 2X, 4X forward speed. DVD: 2X, 4X, 8X forward speed.
23	■ STOP	Stop the playing function.
24	⏸ PAUSE	Only plays one picture when push button.
25	ROOT	Return to root menu.(DVD)
26	SUBTITLE	Selecting subtitles.
27	AUDIO	Language/Audio track selection; VCD: stereo, right or left. DVD: selecting a language.
28	ANGLE	Selecting the camera angle.
29	MODE	Switch player mode and AV in mode. (TV)
30	NAVI	Navigate main menu. (Keep to mould group GPS)
31	RADIO	Switch right or left audio channel (Keep to mould group TV)
32	RETURN	Return to main menu.(VCD)
33	"+" "-" VOL.	To control the volume.
34	CH+	(Keep to mould group TV)
35	CH-	(Keep to mould group TV)

■ Connecting the Player to the TV set

1. Turn OFF the Player's power first before making connections to the TV set.
2. Connect the supplied video cable to the player's video output jack (left side). (Be sure yellow cable to player's and TV's yellow jack and white cable to white jack and red cable to red jack)

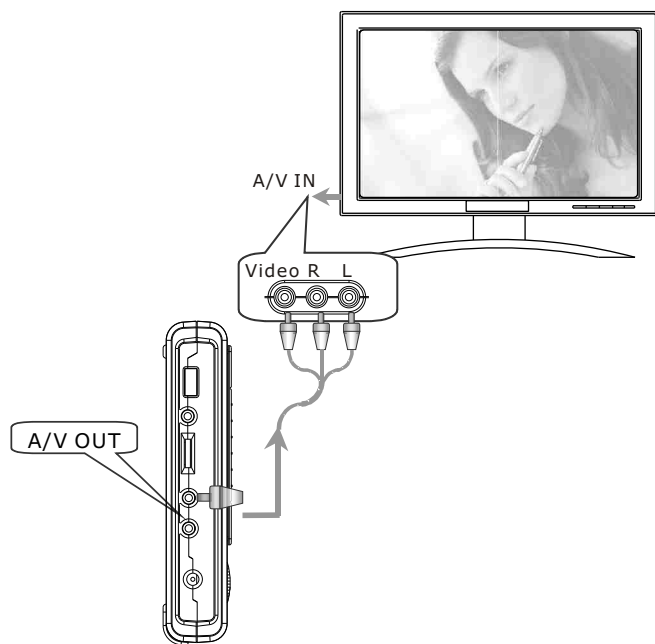

3. Before you use the player with your TV set, be sure to set the video switch to the position that matches the video system (NTSC or PAL) of your TV set. If the switch setting is wrong, the TV set will not display video properly.
4. If your TV set can switch between the two-video systems automatically, set the Video switch on the player to the auto position. In this setting the player reads the information recorded on the disc and selects the video system automatically.

■ Using the earphones on the main unit and on the panel unit

Panel unit's earphone:

1. Set the volume control to "0"
2. Connect the plug of earphones to the player's "PHONES" jack.
3. Adjust the volume control on the panel to the desired sound level.

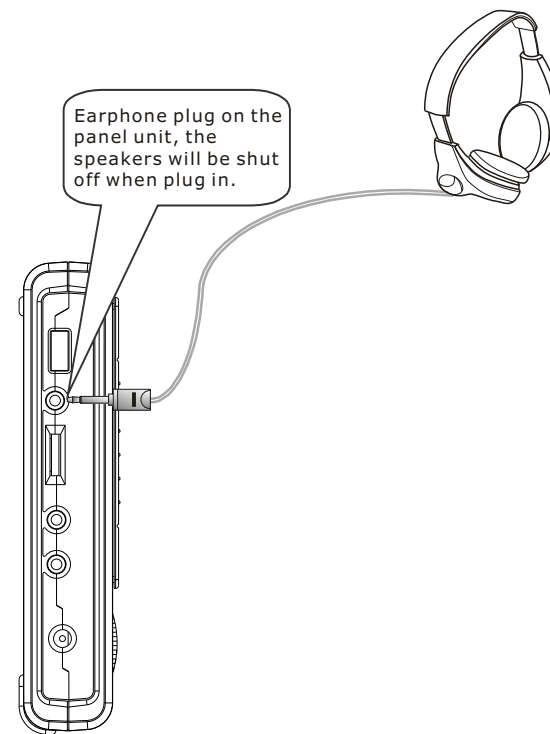

Connecting to an amplifier equipped with a Dolby AC-3

Dolby AC-3

You can still enjoy the excitement of Surround Sound even if A/V receiver does not offer Dolby Digital decoding. If your A/V receiver has a Dolby AC-3 decoded, refer to the following connection diagram.

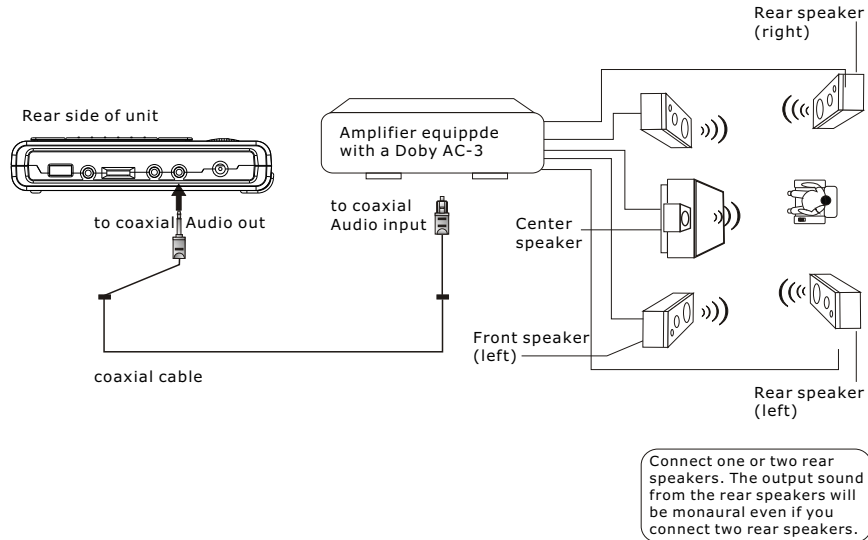

With a receiver equipped with Dolby Digital

Connect the equipment. Refer to that receiver's owner's manual and set the receiver so you can enjoy Dolby AC-3 sound.

Note

Be sure to set Digital Audio Output of this DVD player to PCM/RAW from the SETUP menu when you enjoy sounds of Dolby AC-3 using this connection.

The remote control will operate from a linear distance of approximate 5 meters and within a horizontal and vertical range of 30 degrees.

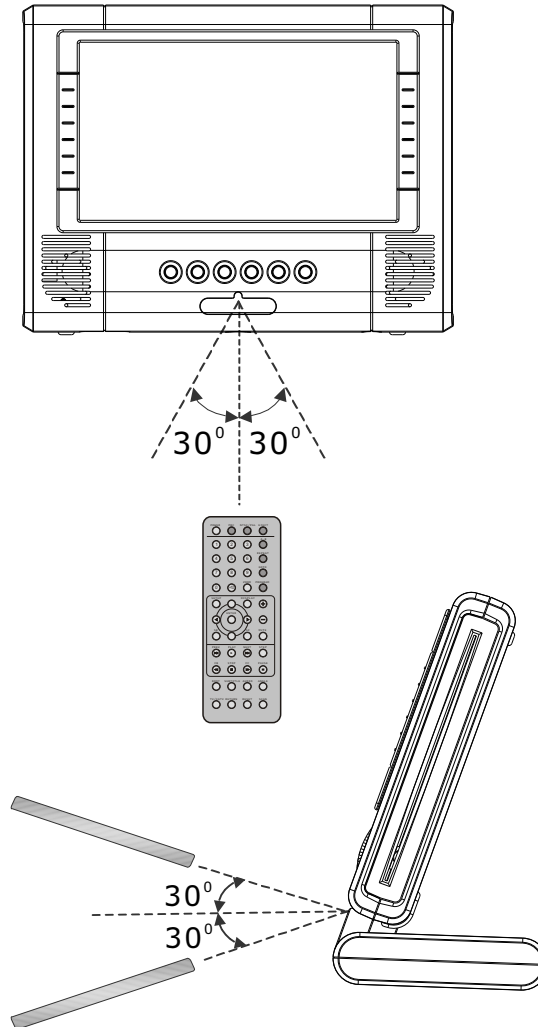

Caution

1. Use the player will be danger when you press over 18°.
2. Don't rock the machine violently.

1

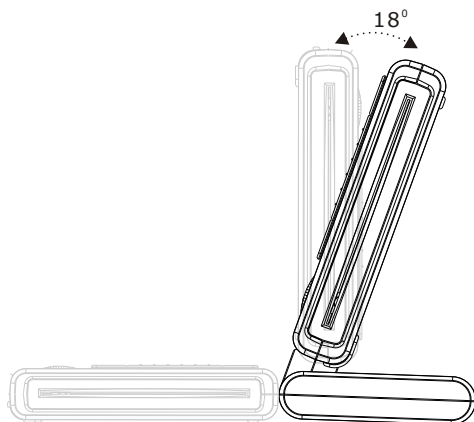

2

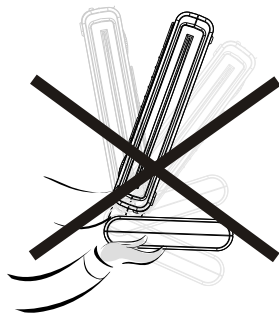

3. Don't put this battery such opposite direction.

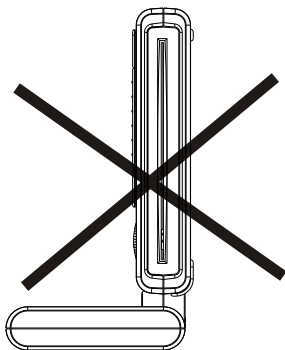

Corrosion, oxidation, battery-leakage and any other gradually acidic defect of this nature will invalidate the guarantee.

Basic Operation Procedures of the Player

This section will tell you how to play the disc.

1. Turn "POWER ON" .
2. Hold the disc facing label side.
Insert the disc, the player will suck automatically.
3. After the player recognizes the disc, the player begins to play the disc.
4. During play:
 - a. Press "PAUSE" button to freeze playing temporarily and press "PLAY (▶)" button for starting to play again.
 - b. Press "STOP (■)" button to stop playing.
 - c. Press "NEXT (▶▶)" button to jump to next track.
 - d. Press "PREV (◀◀)" button to jump to previous track.
 - e. Press "F.F. (▶▶▶)" button to play the disc in fast forward mode.
 - f. Press "F.B. (◀◀◀)" button to play the disc in fast backward mode.
5. During stop:
 - a. Press "PLAY (▶)" button to start playing disc.
 - b. Press "STOP (■)" button to stop playing.
 - c. Press "NEXT (▶▶)" button to select next track.
 - d. Press "PREV (◀◀)" button to select previous track.
6. To extract the disc, press "EJECT" button to stop the player and the disc will be ejected automatically.
7. To turn the player off.

■ Playback

Getting ready to play

Turn on the television and set the video source to connect to DVD player.

* Turn on the audio device connected to the DVD player. If no other audio amplifier connected, your TV is the audio device.

1. Turn on the power switch of the DVD player. Press power button on the remote control.
2. Load a disc with the label side front.
3. Your player should automatically play the disc. If the player does not begin to play, press button to start.

■ Stop Playback

Press ■ on the remote control or STOP on the unit

When stop is pressed during playback, the DVD player remembers the place at which playback stopped.

To resume play from the point where it stopped, just press play.

To clear the point to be resumed, press ■ stop again during stop.

■ Pause Playback

Press II on the remote during playback. Press PLAY button to resume normal playback.

■ Playing at Fast Speed

Press F.F.(▶▶) or F.B.(◀◀) button during playback.

The playback speed changes each time you press the F.F. or F.B. Button.

■ Playback in Slow Motion

Press the SLOW button (S.B. or S.F.) during playback

The playback speed becomes 1/2, 1/4, or 1/8 of the normal speed each time you press the SLOW button (S.B. or S.F.).

Note: During fast playback or slow motion playback, the sound is muted.

To resume normal playback, press PLAY.

■ Repeat Playback

Repeat a Title, Subtitle, or Track

1. Select the title, subtitle, or track you want to repeat.
2. Press the REPEAT button.

■ Repeat a Section Between Points A and B

1. During playback, press REPEAT A-B button on the remote control at the starting point of the section you want to repeat. (Point A)
2. Press REPEAT A-B button again at the ending point of the section you want to repeat. (Point B)
3. Press REPEAT A-B button again to cancel the A-B repeat function.

■ Zoom Function

Press ZOOM on the remote control during playback. The picture around the center of the screen is enlarged to 4 times. Press ZOOM again to return to normal. During zoom playback, you can press ▲▼◀▶ to move the enlarged picture.

■ Changing The Angle

Press the ANGLE button while playing back a scene recorded with multiple angles. If your DVD disc is not recorded with multiple angles, press ANGLE button will not have any effect.

■ Changing The Audio/language

Press the AUDIO button during playback, you can select different options of language and sound recording system from those included on the DVD videodisc.

■ Locating A Title, Subtitle Or Track

Press TITLE button and use number keys or ▲▼ buttons to locate your desired sections. This DVD player also allows using SKIP NEXT or PREV button repeatedly to display the requested title or track.

■ Selecting Subtitles

You can select a preferred subtitle from those included on the DVD videodisc by pressing SUBTITLE button during playback. Use arrow keys to move cursor to ON or OFF position and press SUBTITLE again to change it.

■ Step Play:

This function enables you to view frames in sequence.

1. Press the STEP button during play, a frame is displayed on the screen with no sound.
2. Press the STEP button a second time, the player displays the next frame one frame at a time in sequence.
3. Pressing the "PLAY (▶)" button during step play, normal play will resume.

■ MUTE Button:

Pressing the MUTE button will shut off the audio output

■ On Screen Display (OSD)

* Using the Display Feature (compatible with DVD, MP3/JPEG discs)

1. Loading and playing DVDs (two pages)
Press Display button once to show the first page:
"Disc Type, Title * / * (the playing title / total titles), Chapter * / * (the playing chapter / total chapters), Elapsed Time of the Disc" .
Press the button again to show the second page:
"Language * / * (the serial number of playing language / the amount of optional languages) or Off, Language Type, Audio Type, Subtitle * / * (the serial number of playing subtitle / the amount of optional subtitles) or Off, Angle * / * (the serial number of playing angle / the amount of optional angles) or Off" .
Press the button for the third time, the display menu fades out.

■ Number Buttons: (0,1,2,3,4,5,6,7,8,9,+10)

If the Time or Track number selection is larger than 10. Enter the number using the following procedure: (For example, to select number 16)

1. Press the +10 button once, then "1-" is shown on the display.
2. Press the 6 button, then "16 " is shown on the display.

■ GO TO button:

Press the GO TO button during the PBC is off will display the time XX: XX and press the "PLAY (▶)" button which indicate the assigned location to play.

■ Programmed Play:

At first, press the STOP button and then press the PROGRAM button which P XX:XX (Program No.):(Track No.) is displayed in the screen:

1. Enter the first selection/track that you want to play, you do this by pressing the corresponding number of the selection/track on the numeral pad of the Remote control.
2. For multiple selections repeat step 1 for as many selections/tracks that you desire.
3. After making all of your selections, press the "PLAY (▶)" button, the disc playing will be in the order that you selected.

■ SETUP button

Press the Setup button, the main setup menu appears.

.. When the main menu displayed, the DVD system will auto pause.

1. **SYSTEM SETUP** allows you to change SCREEN SAVER, RATING, DEFAULT. **RATING** The Rating feature is a rating limit system, like movie ratings. It works with DVD discs that have been assigned a rating. This helps you control the types of DVDs that your family watches.
..There are two rating options: NO ADULT and KID SAFE.
..Select the VIEW ALL option to cancel the rating limit.
The default setting is VIEW ALL.

*Notes: .. If the password option is locked, you cannot set the ratings limit; the rating limit doe not work when the password option unlocked.
(Default password"0000")*

2. **LANGUAGE SETUP** gives you options to change OSD LANGUAGE option , AUDIO LANG option, SUBTITLE LANG option, MENU LANG option.

The language setup options are illustrated below:

Highlight the OSD LANGUAGE option, and press the Arrow buttons to choose the OSD language you prefer.

Press Enter to confirm, and it will display OSD in that language;...

3. Highlight the AUDIO OUT option, and press the Arrow buttons to choose the audio output mode you prefer. Press Enter to confirm;
4. The video setup options are illustrated below:
BRIGHTNESS Use the Up and Down arrow button to move the scroll and adjust the brightness, **CONTRAST** Use the Up and Down arrow button to move the scroll and adjust the contrast, **HUE** Use the Up and Down arrow button to move the scroll and adjust the hue.
SATURATION Use the Up and Down arrow button to move the scroll and adjust the saturation.

- The speaker setup options are illustrated below: Use the Up and Down arrow button to move the scroll and adjust the saturation.
- The video setup options are illustrated below:
DYNAMIC RANGE: When "LINE OUT" is selected, choose this setting to adjust the line out ratio and get different effect. If adjusting to FULL, the audio signal peak value will be the minimum; while adjusting to OFF, maximum.
DUAL MONO (LEFT + RIGHT) Choose this option to setup the L and R mono output mode; There are four modes in this option: STEREO, MONO L, MONO R, and MIX MONO; It is mainly used in karaoke mode.



■ USB & CARD Device

Insert the USB Storage Device into the USB slot, or insert the memory card into the cardreader slot, the DVD player will initialize the disc and the directory (folder) will be shown. Please note the direction of the card, as the picture below; and it cannot work, when you are playing the disc..

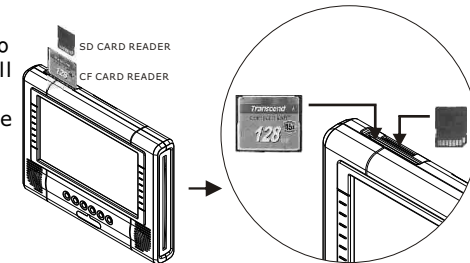

■ MENU Screen Display

When an MP3/JPEG/MP4 USB or card is inserted into the unit, the menu screen appears automatically. You can use the menu screen to change folders and files. The system plays the songs, photos or movies in the order they were burned onto the device.

■ Note:

- The USB 1.1 device is a USB host device. You can play the songs, photos or movies files that were stored in your USB storage device, It can not connect with PC.
- Support card FORMAT
 - MultiMedia Card (MMC) (Capacity up to 256MB)
 - Secure Digital Card (SD) (Capacity up to 256MB)
 - Memory Stick (MS) (Capacity up to 256MB)
 - CF Card

■ Support Format

- PHOTO Viewer
 - JPEG format
 - Resolution up to 2048*1536 pixels
 - Zoom in/out
 - Rotate
 - Slide show
- Music
 - MP3
 - Audio CD
- MPEG1 Video
 - DAT and MPG file support
 - 352*240 @ 30fps
 - MPEG1 audio layer II
- MPEG4 Video
 - MP4 and AVI file support
 - 320*240 @ 30fps
 - AAC audio
- DivX Video
 - AVI file support
 - 640*480 @ 30fps
 - MP3 audio
 - DivX 3.0 /4.0 /5.0

MP3/JPEG/MPEG4 Operation

Insert an MP3/JPEG/MP4 CD, the DVD player will initialize the disc and the directory (folder) will be shown .

■ MENU Screen Display

When an MP3/JPEG/MP4 disc is inserted into the unit, the menu screen appears automatically. You can use the menu screen to change folders and files. The system plays the songs, photos or movies in the order they were burned onto the disc.

■ Playing MP3 and JPEG discs

Place a MP3 / JPEG disc into the tray, and the player will auto search the directories saved MP3 / JPEG files. After searching, it will auto go to the first directory saved MP3 files (to the disc containing both mp3 and jpeg files; To the disc containing single type of files, it will auto go to the first directory) and play the first song in the directory ("01:" is highlighted). The screen displays as the picture below:

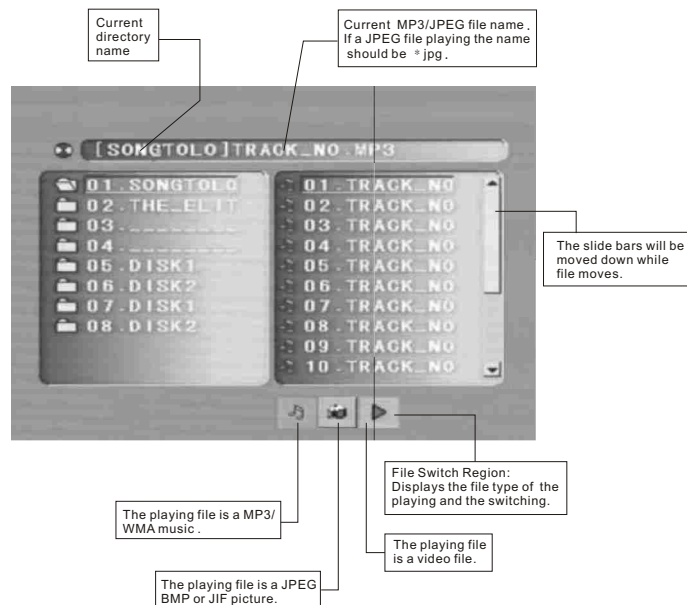

MP3/JPEG/MPEG4 Operation

■ MP3 Playback

MP3 is the abbreviation for MPEG-1 layer 3. MP3 format conforms to the International standard for MPEG-1 layer3, or in other words, the third level of sound compression. When digital sounds, (music) is compressed to MPEG-1 layer 3, a single Compact Disc (CD) can store more than 10 hours of playing time or approximately 150 song titles. The quality of MP3 sounds is similar to that of a standard CD recording.

■ Using Remote Control to select song titles

1. Put the MP3 disc into the disc compartment and close the cover, then wait for the player to complete detecting the disc.
2. Press the Number Buttons direct to select the song title desired.
3. If the song title number is below the numeral 9, then press Number Buttons 0-9.
4. If the song title number is above the numeral 10, then press +10 and the numeral desired.
5. For example: The No. 106 song title is to be selected: Press +10 button ten times, then press 6. The number desired will be shown on the screen. Press "PLAY (▶)" button to start the song title.

■ JPEG Playback

With this DVD player you can view Kodak picture CDs and JPEG pictures for viewing on the screen

Basic Playback

1. Load a Kodak picture CD or a JPEG picture CD. After few seconds, the player starts to display the menu screen automatically.
2. You can select a picture to view by pressing play key or it's corresponding number corresponding to the order of the picture. This player will begin to display the slide show from the selected picture. To stop slide show, press the STOP button.
3. Press **PAUSE** to pause the slide show.
4. Press **NEXT** and **PREVIOUS** to view the next or previous picture.
5. Press > or < key to rotate the picture by 90 degree.

■ DivX(MPEG-4) Playback

MPEG-4 is an ISO/IEC standard developed by MPEG (Moving Picture Experts Group), MPEG-4 is a very efficient digital video compression standard, which can compress MPEG-2 video into about one eighth of its original size. Most video stream medias base on this technology, such as MPEG-4, and so on. MPEG-4 is the most popular digital video technology in the video communication.

Basic Playback

1. Load a MPEG-4 CD. After few seconds, the player starts to display the menu screen automatically.
2. You can select a MPEG-4 movie to view by pressing play key or it's corresponding number corresponding to the order of the files.
3. Press **NEXT** and **PREVIOUS** to view the next or previous movie.

■ Monitor installation for the vehicle with headrest mount

- Step 1. Slide the headrest mount teeth into the end of 7" monitor back slot.
Step 2. Pull the 2 straps on the monitor mount through the top 2 loops on the back of the monitor bag.
Step 3. Wrap the 2 straps around the headrest vertically.
Step 4. Pull the 2 straps tightly and secure the monitor mount with attached TFT LCD monitor to the headrest.

Step 1.

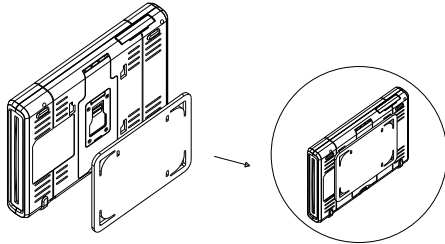

Step 2.

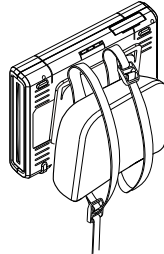

Step 3.

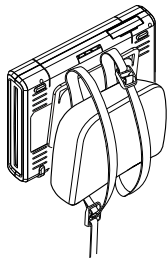

Step 4.

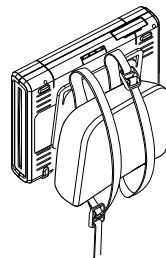

If it appears that your DVD-Video player is faulty, first consult this checklist. It may be that something simple has been overlooked. Under no circumstances should you try to repair the player yourself, as this will invalidate the warranty. Only qualified service personnel can remove the cover or service this player.

NO POWER

- . Check if the on/off button is turned on.
- . Check if power plug is properly connected.
- . Check if there is power at the AC outlet by plugging in another appliance.

NO PICTURE

- . Check if the TV is switched on.
- . Select the correct AV input on the TV.
- . Check the video connection.
- . Check if channel selector is set to AV on the TV. (See your TV manual for instructions).

DISTORTED PICTURE

- . Check the disc for fingerprints and clean with soft cloth, wiping from center to edge.
- . Sometimes a small amount of picture distortion may appear. This is not a malfunction.

COMPLETELY DISTORTED PICTURE

- . The disc is not formatted to the TV-set used (PAL/NTSC).

NO COLOUR IN PICTURE

- . The disc is not formatted to the TV-set used (PAL/NTSC).
- . Ensure DVD player is not connected through VCR.

DISC CANNOT BE PLAYED

- . Ensure the disc is label side up.
- . Clean the disc.
- . Check if the disc is defective by trying another disc.
- . Due to the reason of incapability, our MP3 function cannot read some discs.

NO SOUND

- . Check audio connections.
- . If using a HiFi amplifier, try another sound source.
- . Check that DTS is selected in the Audio Menu if a DTS disc is played.
- . Ensure that there is a DTS decoder connected when selecting DTS.

NO RETURN TO START-UP SCREEN WHEN DISC IS REMOVED

- . Check to see if the program requires another disc to be loaded.
- . Reset by unplugging the player from the power, then connect the power again.

THE PLAYER DOES NOT RESPOND TO THE REMOTE CONTROL

- . Aim the remote control directly at the sensor on the front of the player.
- . Avoid all obstacles, which may interfere with the signal path.
- . Inspect or replace the batteries.

NO AUDIO AT DIGITAL OUTPUT

- . Check the digital connections.
- . Check the Digital Out menu to make sure that the digital output is correctly set.
- . Check if the audio format of the selected audio language matches your receiver capabilities.

BUTTONS DO NOT WORK

- Unplug the player from power outlet and reconnect after a few seconds.

Before calling for service, it is advisable to refer to the troubleshooting table below:

Symptoms	Possible causes	Remedies
No color LCD display	Main power switch is "OFF"	Switch the Main power to "ON"
No startup logo of DVD Player	DVD Player's power switch did not "ON"	Switch the Main power and Player's power to "ON"
No sound from the color LCD speakers	Color LCD's volume control is in the minimum position	Turn the volume up
Low Battery indicator is on	Battery charge is low	Connect the DC adapter to charge the battery
Disc cannot be played	Disc is loaded incorrectly	Disc is loaded incorrectly
	Disc is dirty	Clean the disc
	Disc is scratched or warped	Replace the disc
Nothing is displayed on the TV screen	Video cable is disconnected	Connect the cable firmly
	Input selector on the TV set is set improperly	Adjust the TV set input selector so that the TV received video signals from DVD player
Sound is not heard from the speakers	Audio cable is disconnected	Connect the cable firmly
	Input selector on the amplifier is set improperly	Set the selector properly

THIS PRODUCT COMPLIES WITH DHHS RULES 21 SUBCHAPTER J PARTS 1040-10 AND 1040-11 AT DATE OF MANUFACTURE.

Manufactured under license from Dolby Laboratories. "Dolby" and the double-D symbol are trademarks of Dolby Laboratories. Confidential Unpublished Works. ©1992-1997 Dolby Laboratories, Inc. All rights reserved.

Apparatus Claims of U.S. Patent Nos. 4,631,603; 4,819,098; 4,907,093; 5,315,448 and 6,516,132 licensed for limited viewing uses only

This device complies with part 15 of the FCC Rules. Operation is subject to the following two conditions : (1) This device may not cause harmful interference, and (2) this device must accept any interference received, including interference that may cause undesired operation.

Software License
All software that is supplied as part of this equipment is protected by copyright laws and international copyright treaties, as well as other intellectual property laws and treaties. This software is licensed, not sold and is intended for use on this device only.

Items	Specifications
Dimension	208mm(W) x158mm(D) x 30mm(H)
Weight	800g (with DVD)
LCD Screen (16:9)* Model : VDA730D / VDA730D-1	7" 16:9 WIDE-TYPE TFT DISPLAY RESOLUTION 1440(H) x 234(V) Response time 30ms View angle (U/D/L/R) 40°/55°/60°/60°
Disc Physical Format	8/12cm DVD, VCD, CD
Video System	NTSC / PAL
Video Decompression	MPEG-2 (ISO / IEC-13818), MPEG-1, JPEG, MP3 / CDDA
Video Output	Composite
Audio Output	2-Channel Stereo Analog Audio out / coaxial out
Power Consumption	<15 Watt (Charge Mode <30 watt)
IR Remote Control	38KHZ
Effective Range	5 meters
No. Of keys	48
Battery	CR2025 x 1.3V
Operation Condition	5°C ~ +50°C, 15% ~ 85%RH
CardReader support the following types of Flash Memory Cards	-CompactFlash Card (Capacity up to 256MB) -MultiMedia Card (MMC) (Capacity up to 256MB) -Secure Digital Card (SD) (Capacity up to 256MB) -Memory Stick (MS) (Capacity up to 256MB)



This symbol on the product or in the instructions means that your electrical and electronic equipment should be disposed at the end of its life separately from your household waste. There are separate collection systems for recycling in the EU.

For more information, please contact the local authority or your retailer where you purchased the product.