



# Dehumidifiers

**Owner's Manual**

AHG20

## SAFETY PRECAUTIONS

When using this dehumidifier, always follow basic safety precautions, including the following:

- Use this appliance only for its intended purpose as described in this Owner's Manual.
  - **This dehumidifier must be properly installed and grounded as described in this manual before it is used.**
  - **Never operate this dehumidifier in an area that is likely to accumulate standing water.** If this condition develops, for your safety disconnect the power supply before stepping into the water.
  - Never unplug your dehumidifier by pulling on the power cord. Always grip plug firmly and pull straight out from the receptacle.
  - **Repair or replace immediately all electric service cords** that have become frayed or otherwise damaged. Do not use a cord that shows cracks or abrasion damage along its length or at either the plug or connector end.
  - Turn the humidity control to **OFF** and unplug your dehumidifier before making any repairs or cleaning.
- NOTE:** We strongly recommend that any servicing be performed by a qualified individual.
- For your safety, do not store or use combustible materials, gasoline or other flammable vapors or liquids in the vicinity of this or any other appliance.



**READ AND FOLLOW THIS SAFETY INFORMATION CAREFULLY.**  
**SAVE THESE INSTRUCTIONS**

# IMPORTANT SAFETY INFORMATION. READ ALL INSTRUCTIONS BEFORE USING.

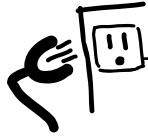

## HOW TO CONNECT ELECTRICITY

*Do not, under any circumstances, cut or remove the third (ground) prong from the power cord. For personal safety, this appliance must be properly grounded.*

The power cord of this appliance is equipped with a 3-prong (grounding) plug which mates with a standard 3-prong (grounding) wall outlet to minimize the possibility of electric shock hazard from this appliance.

Have the wall outlet and circuit checked by a qualified electrician to make sure the outlet is properly grounded.

Where a 2-prong wall outlet is encountered, it is your personal responsibility and obligation to have it replaced with a properly grounded 3-prong wall outlet.

The dehumidifier should always be plugged into its own individual electrical outlet which has a voltage rating that matches the rating plate.

This provides the best performance and also prevents overloading house wiring circuits which could cause a fire hazard from overheated wires.

## **⚠ WARNING!**



## USE OF EXTENSION CORDS

*Because of potential safety hazards under certain conditions, we strongly recommend against the use of an extension cord.*

However, if you must use an extension cord, it is absolutely necessary that it be a UL-listed, 14 gauge, 3-wire grounding type appliance extension cord having a grounding type plug and outlet and that the electrical rating of the cord be 15 amperes (minimum) and 125 volts.



## USE OF ADAPTER PLUGS

*Because of potential safety hazards under certain conditions, we strongly recommend against the use of an adapter plug.*

However, if you must use an adapter, where local codes permit, a **temporary connection** may be made to a properly grounded 2-prong wall outlet by use of a UL-listed adapter available at most local hardware stores.

The larger slot in the adapter must be aligned with the larger slot in the wall outlet to provide proper polarity in the connection of the power cord.

When disconnecting the power cord from the adapter, always hold the adapter in place with one hand while pulling the power cord plug with the other hand. If this is not done, the adapter ground terminal is very likely to break with repeated use.

If the adapter ground terminal breaks, **DO NOT USE** the dehumidifier until a proper ground has been established.

*Attaching the adapter ground terminal to a wall outlet cover screw does not ground the appliance unless the cover screw is metal, and not insulated, and the wall outlet is grounded through the house wiring. You should have the circuit checked by a qualified electrician to make sure the outlet is properly grounded.*



**READ AND FOLLOW THIS SAFETY INFORMATION CAREFULLY.**

**SAVE THESE INSTRUCTIONS**

# GE & You, A Service Partnership.



## IMPORTANT!

Fill out the Consumer Product Registration Card.

### Two easy ways to register your appliance!

- Through the internet at [www.geappliances.com](http://www.geappliances.com)
- Complete and mail the enclosed Product Registration Card



## FOR YOUR RECORDS

Write the model and serial numbers here:

# \_\_\_\_\_

# \_\_\_\_\_

You can find them on a label on the back of the dehumidifier behind the bucket.

### Staple sales slip or cancelled check here.

Proof of the original purchase date is needed to obtain service under the warranty.

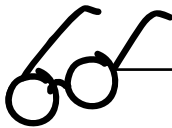

## READ THIS MANUAL

Inside you will find many helpful hints on how to use and maintain your dehumidifier properly. Just a little preventive care on your part can save you a great deal of time and money over the life of your dehumidifier.



## IF YOU NEED SERVICE

You'll find many answers to common problems in the *Before You Call For Service* section. If you review our chart of *Troubleshooting Tips* first, you may not need to call for service at all.

If you do need service, you can relax knowing help is only a phone call away. A list of toll-free customer service numbers is included in the back section. Or, you can always call the GE Answer Center® at 800.626.2000, 24 hours a day, 7 days a week.

**OR**

Visit our Website at: [www.geappliances.com](http://www.geappliances.com)

## Safety Information

Safety Precautions	..... Front Cover, 2
How to Connect Electricity	..... 2
Use of Extension Cords	..... 2
Use of Adapter Plugs	..... 2

## Operating Instructions

Controls	..... 4
Location	..... 4
Removing Collected Water	..... 5
Cleaning the Air Filter	..... 5

## Troubleshooting Tips

Before You Call For Service	..... 6
-----------------------------	---------

## Customer Service

Warranty	..... 7
Service Telephone Numbers	..... Back Cover

Safety Instructions

Operating Instructions

Troubleshooting Tips

Customer Service

## About the controls and features of the dehumidifier.

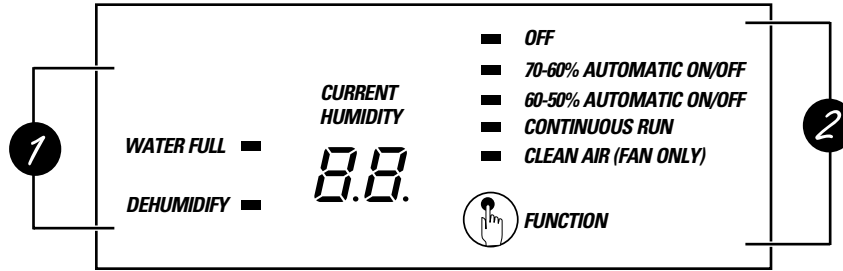

### Controls

**1 WATER FULL Indicator**  
Blinks when the bucket is full or not in place.

#### **DEHUMIDIFY Indicator**

Lights when the compressor (dehumidifying function) is on.

#### **CURRENT HUMIDITY Display**

Shows the ambient humidity. The range displayed is 39-95%. If the current humidity is below 39%, it will still show 39.

#### **Auto Defrost Feature**

When frost builds up on the cooling coils, the compressor will cycle off until the frost disappears. The fan continues to run.

**2 FUNCTION**  
When you first plug in the dehumidifier, it goes through a self-test. When the **OFF** light comes on, keep pressing the **FUNCTION** pad to make your selection.

#### **70-60% AUTOMATIC ON/OFF**

The dehumidifier runs when the humidity in the room exceeds 70%. The compressor stops but the fan will run when the humidity is below 60%.

#### **60-50% AUTOMATIC ON/OFF**

Same as above, but at 60% and 50%.

#### **CONTINUOUS RUN**

Continuously dehumidifies until bucket is full or humidity is below 35%.

#### **CLEAN AIR (FAN ONLY)**

The compressor is off, but the fan runs.

### Choosing a Location

- The dehumidifier must be operated in an enclosed area to be most effective.
- Close all doors, windows and other outside openings to the room.

Place the dehumidifier in a location that does not restrict air flow into the rear coil or out the front grille.

A dehumidifier operating in a basement will have little or no effect in drying an adjacent enclosed storage area, such as a closet, unless there is adequate circulation of air in and out of the area.

### Air Direction

Make sure the louvers are open before starting the unit.

The louvers can be adjusted to blow air upward or straight out.

It is normal for the surrounding air to become slightly warmer as the dehumidifier operates. This warming effect further reduces the relative humidity of the surrounding air.

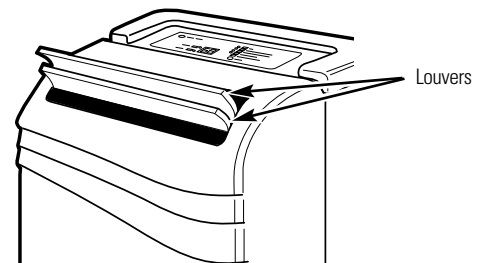

## Removing Collected Water

There are 2 ways to remove collected water:

- 1 **Use the bucket.** When the bucket is full, the **WATER FULL** indicator blinks and the unit beeps 3 times and stops. Wait a few minutes before removing the bucket to allow the water to stop dripping.

**To remove:** Tilt the bucket forward then lift carefully. After emptying, clean and replace it.

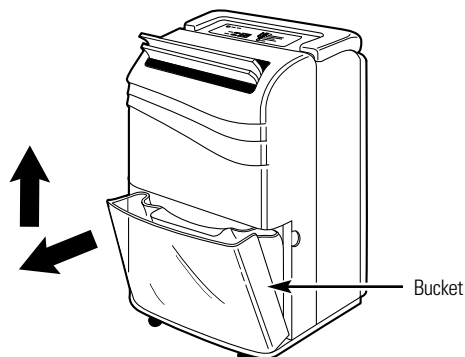

- 2 **Use a hose.** Water can be automatically emptied into a drain by attaching a length of thin-wall rubber or plastic tubing with an inside diameter of 1/2 inch. Use a screwdriver to remove the knockout at the back. Attach the tubing to the connector through the hole. The tubing should lead to the drain with no sharp bends.

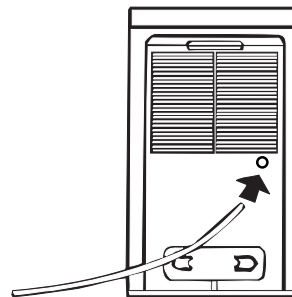

## Cleaning the Grille and Case

Turn the dehumidifier off and remove the plug from the wall outlet before cleaning.

Use water and a mild detergent to clean the inlet and outlet grilles. Do not use bleach or abrasives.

## Air filter

**NOTE:** The charcoal filter has been packed separately, in the bucket, in the front of the unit. Remove the wrap and insert it in the filter frame with the darker surface up.

The air filter is on the back of the dehumidifier. It should be checked and cleaned at least every 2 to 3 weeks or more often if necessary.

**To remove:** Turn the dehumidifier off and lift out the filter on the back of the unit.

Vacuum the nylon filter or wash with water. Make sure it is dry before replacing it.

The charcoal filter should be replaced every 3 to 6 months or when the inside surface has changed from white to a dark color.

Call 800-626-2002 to order a replacement.

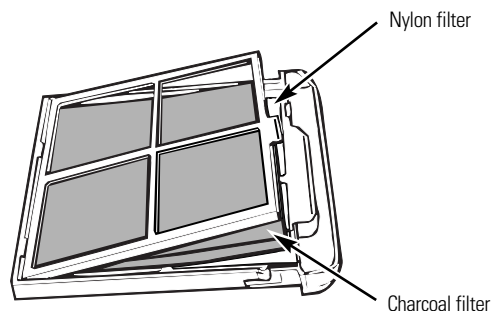

## Before you call for service...



### Troubleshooting Tips

Save time and money! Review the chart below first and you may not need to call for service.

<b>Problem</b>	<b>Possible Causes</b>	<b>What To Do</b>
<b>Dehumidifier does not start</b>	<b>The dehumidifier is unplugged.</b>	<ul style="list-style-type: none"> <li>• Make sure the dehumidifier plug is pushed completely into the outlet.</li> </ul>
	<b>The fuse is blown/circuit breaker is tripped.</b>	<ul style="list-style-type: none"> <li>• Check the house fuse/circuit breaker box and replace the fuse or reset the breaker.</li> </ul>
	<b>The bucket is full.</b>	<ul style="list-style-type: none"> <li>• The dehumidifier automatically turns off when this occurs. Empty the bucket.</li> </ul>
<b>Dehumidifier does not dry the air as it should</b>	<b>Did not allow enough time to remove the moisture.</b>	<ul style="list-style-type: none"> <li>• When first installed, allow at least 3 or 4 days to maintain the desired dryness.</li> </ul>
	<b>Airflow is restricted.</b>	<ul style="list-style-type: none"> <li>• Make sure there are no curtains, blinds or furniture blocking the front or back of the dehumidifier.</li> <li>• Clean the filter.</li> </ul>
	<b>The control may not be set correctly.</b>	<ul style="list-style-type: none"> <li>• Choose a lower humidity range or <b>CONTINUOUS RUN</b>.</li> </ul>
	<b>Doors and windows may not be closed tightly.</b>	<ul style="list-style-type: none"> <li>• Check that all doors, windows and other openings are securely closed.</li> </ul>
	<b>Clothes dryer may be blowing moisture-laden air into the room.</b>	<ul style="list-style-type: none"> <li>• Install the dehumidifier away from the dryer. The dryer should be vented to the outside.</li> </ul>
	<b>Room temperature is too low.</b>	<ul style="list-style-type: none"> <li>• The unit will not operate satisfactorily if the room temperature is below 60°F.</li> </ul>
<b>Dehumidifier runs too much</b>	<b>Area to be dehumidified is too large.</b>	<ul style="list-style-type: none"> <li>• Check with your dealer to see if the capacity is adequate.</li> </ul>
	<b>Doors and windows are open.</b>	<ul style="list-style-type: none"> <li>• Close all doors and windows to the outside.</li> </ul>
<b>Frost appears on the coils or bucket</b>	<b>Dehumidifier has been recently turned on or room temperature is below 60°F.</b>	<ul style="list-style-type: none"> <li>• This is normal. Frost will usually disappear within 60 minutes.</li> </ul>
<b>Fan noise</b>	<b>Air is moving through the dehumidifier.</b>	<ul style="list-style-type: none"> <li>• This is normal.</li> </ul>
<b>Water on floor</b>	<b>Connection may be loose.</b>	<ul style="list-style-type: none"> <li>• Check the hose if one is attached.</li> </ul>

# Dehumidifier Warranty



All warranty service provided by our Factory Service Centers, or an authorized Customer Care® technician. For service, call 800-GE-CARES.

<b>For The Period Of:</b>	<b>GE Will Replace:</b>
<b>One Year</b> From the date of the original purchase	<b>Any part</b> of the dehumidifier which fails due to a defect in materials or workmanship. During this <b>full one-year warranty</b> , GE will also provide, <b>free of charge</b> , all labor and in-home service to replace the defective part.
<b>Five Years</b> From the date of the original purchase	<b>Any part of the sealed system</b> (the compressor, condenser, dehumidifying coil and all connecting tubing) if it should fail due to a defect in materials or workmanship. During this <b>five-year warranty</b> , GE will also provide, <b>free of charge</b> , all labor and in-home service to repair or replace any part of the sealed system.

## What GE Will Not Cover:

- Service trips to your home to teach you how to use the product.
- Improper installation. If you have an installation problem, or if the dehumidifier is of improper dehumidifying capacity, contact your dealer or installer. You are responsible for providing adequate electrical, plumbing and other connecting facilities.
- Failure of the product resulting from modifications to the product or due to unreasonable use including failure to provide reasonable and necessary maintenance.
- In commercial locations labor necessary to move the unit to a location where it is accessible for service by an individual technician.
- Replacement of house fuses or resetting of circuit breakers.
- Failure due to corrosion on models not corrosion-protected.
- Damage to the product caused by improper power supply voltage, accident, fire, floods or acts of God.
- Incidental or consequential damage to personal property caused by possible defects with this dehumidifier.

*This warranty is extended to the original purchaser and any succeeding owner for products purchased for home use within the USA. In Alaska, the warranty excludes the cost of shipping or service calls to your home.*

*Some states do not allow the exclusion or limitation of incidental or consequential damages. This warranty gives you specific legal rights, and you may also have other rights which vary from state to state. To know what your legal rights are, consult your local or state consumer affairs office or your state's Attorney General.*

**Warrantor: General Electric Company, Louisville, KY 40225**



## Service Telephone Numbers.



### GE Answer Center® 800.626.2000

The GE Answer Center® is open 24 hours a day, 7 days a week.

**OR**

Visit our Website at: [www.geappliances.com](http://www.geappliances.com)



### In-Home Repair Service 800-GE-CARES (800-432-2737)

Expert GE repair service is only a phone call away.



### Special Needs Service 800.626.2000

#### 800-TDD-GEAC (800-833-4322)

GE offers, free of charge, a brochure to assist in planning a barrier-free kitchen for persons with limited mobility.



### Service Contracts 800-626-2224

Purchase a GE service contract while your warranty is still in effect and you'll receive a substantial discount. GE Consumer Service will still be there after your warranty expires.

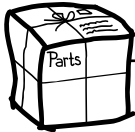

### Parts and Accessories 800-626-2002

Individuals qualified to service their own appliances can have parts or accessories sent directly to their homes (VISA, MasterCard and Discover cards are accepted).

**Instructions contained in this manual cover procedures to be performed by any user. Other servicing generally should be referred to qualified service personnel. Caution must be exercised, since improper servicing may cause unsafe operation.**



### Service Satisfaction

If you are not satisfied with the service you receive from GE:

**First**, contact the people who serviced your appliance.

**Next**, if you are still not pleased, write all the details—including your phone number—to:

Manager, Customer Relations  
 GE Appliances  
 Appliance Park  
 Louisville, KY 40225