

1250 ✓ DOMINATOR



Air rifle | Carabine à air comprimé | Carabina de aire comprimido



Universal-Guns.ru

OPERATION INSTRUCTIONS
MODE D'EMPLOI
MANUAL DE INSTRUCCIONES

1250 ✓ DOMINATOR



CAUTION | ATTENTION | ATENCIÓN

For sale to persons over 18 years of age. For your own safety and that of others, read the user's manual carefully before shooting the air gun for the first time. Both sellers and buyers must respect the regulations on use and ownership of air rifles.

En vente libre aux personnes âgées de plus de 18 ans. Pour votre sécurité et celle d'autrui, lisez attentivement et intégralement la notice d'emploi avant d'utiliser l'arme pour la première fois. Les vendeurs, tout comme les acheteurs, ont l'obligation de respecter les normes relatives à l'utilisation et à la possession carabine à air comprimé.

De venta libre a mayores de 18 años. Para su propia seguridad y para la de los demás, lea íntegra y detenidamente las instrucciones de uso antes de disparar el arma por primera vez. Tanto los vendedores como los compradores tienen la obligación de respetar las normas relativas al uso y posesión de carabinas de aire comprimido.

CONTENTS
CONTENU
CONTENIDO

1



Description
Designation
Designación

2



Operation
Emploi
Reglaje

3



Care
Entretien
Mantenimiento

4



Safety instructions
Consignes de
sécurité
Instrucciones de
seguridad

1.1



1250 DOMINATOR

EN

⚠ WARNING: Not a toy. Adult supervision required. Misuse or careless use may cause serious injury or death. May be dangerous up to 625 yards, or 571 meters.

YOU AND OTHERS WITH YOU SHOULD ALWAYS WEAR SHOOTING GLASSES TO PROTECT YOUR EYES. READ ALL INSTRUCTIONS BEFORE USING. BUYER AND USER HAVE THE DUTY TO OBEY ALL LAWS REGARDING THE USE AND OWNERSHIP OF THIS AIRGUN.

THIS AIRGUN IS INTENDED FOR USE BY THOSE 16 YEARS OF AGE OR OLDER.

⚠ WARNING: Lead pellets. Do not inhale dust or put pellets in mouth. Wash hands after handling. This product contains lead, a chemical known to the State of California to cause cancer and birth defects (or other reproductive harm.)

⚠ WARNING: Never leave a loaded gun unattended! Always store your gun unloaded. Engage the safety and make sure the magazine is empty. Keep your gun **out of reach** of children and persons who aren't familiar with it. Store pellets and air cylinders in a separate location in order to prevent use by unskilled or unauthorized persons.

1.2 | THE PARTS OF YOUR NEW AIR RIFLE

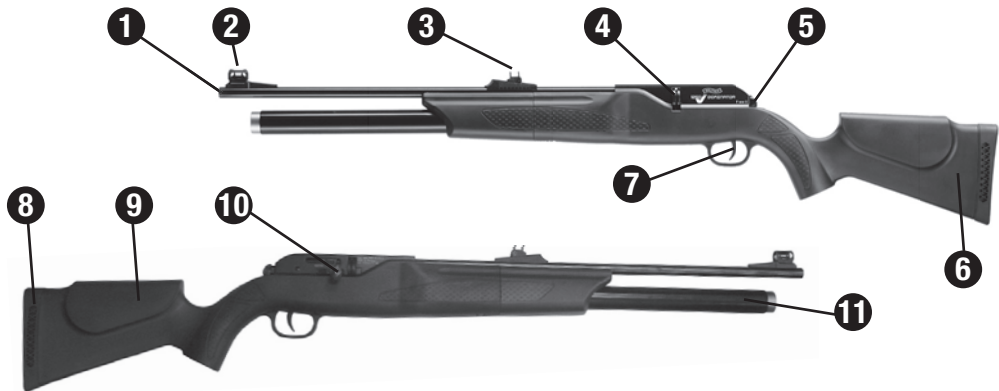

- | | | | |
|----------|-----------------|-----------|-------------------------|
| 1 | Muzzle | 7 | Trigger |
| 2 | Front sight | 8 | Stock end pad |
| 3 | Rear sight | 9 | Cheek piece |
| 4 | Rotary magazine | 10 | Bolt lever |
| 5 | Safety | 11 | Compressed air cylinder |
| 6 | Stock | | |

If you memorize the names of the different parts of your new rifle, it will help you to more easily understand the usage instructions. Read this manual carefully to gain full enjoyment from your new airgun.

2.1 | HANDLING THE SAFETY

After each shot, the airgun will automatically have the safety in place.

- To set the safety manually, pull the safety back, as shown in illustration 1.a, until it is in position (the red mark is hidden). The safety is not "ON SAFE" unless it is pulled all the way back and the RED mark is hidden. The air rifle will not fire when "ON SAFE". Even when the safety is "ON SAFE", you should continue to handle the air rifle safely. Do not ever point the air rifle at any person. Do not ever point the air rifle at anything you do not intend to shoot.
- Handle the airgun only with the safety in place. Always point the barrel of the airgun in a safe direction.

- The rifle is fitted with a double safety system. To deactivate it, you must:
 1. press the fixing lever down and
 2. push the safety button forward (illustration 1.b)The red mark is visible and the airgun is ready for shooting (illustration 1.c).

⚠ WARNING: Keep the air rifle in the "ON SAFE" (S) position until you are actually ready to shoot. Then push the safety to the "FIRE" (F) position.



Illustration 1.a safety activated

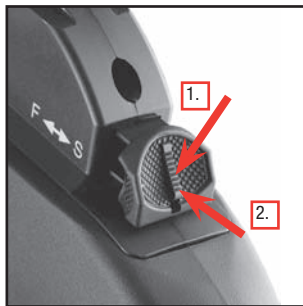

Illustration 1.b



Illustration 1.c ready for shooting

2.2



HANDLING THE COMPRESSED AIR CYLINDER

Note: To guarantee good operation, make sure you use only Walther accessories.

Insert the new compressed air cylinder into the forearm first (Fig. 2.a) and screw it tight. The airgun is now under pressure. To test whether the cylinder has been screwed in correctly, make sure the airgun is not loaded and shoot in a safe direction. If the airgun doesn't fire, check the items in Section 4 "Problems".

CAUTION: The airgun remains under pressure even after removal of the compressed air cylinder.

CAUTION: To release all the pressure, unscrew the compressed air cylinder, remove the rotary magazine and shoot in a safe direction until the airgun can no longer fire.



Fig. 2.a



Fig. 2.b

Filling procedure

The compressed air cylinder can be refilled at any time, even if it is not yet empty. When filling, observe the provisions of the TRG (technical regulations relating to pressurized gas). The maximum permissible filling pressure of 300 bars must not be exceeded under any circumstances. Observe applicable national statutory regulations for refilling. Cylinders which are leaky or otherwise unsafe must not be refilled. Empty them in a safe manner. Screw the adapter onto the refill cylinder and tighten it. Then screw the compressed air cylinder onto the adapter and tighten it securely. Open the cylinder valve for approx. 5 seconds and then close it. Remove the cylinder and screw it back onto the airgun. Compressed air cylinders must never be used or stored above maximum pressure.

WARNING: Never try to use force when inserting a compressed air cylinder.

WARNING: Do not store compressed air cylinders at temperatures above 50°C (122 °C).

CAUTION: When you pierce a compressed air cylinder, make sure the airgun is in "ON SAFE" and that the barrel is pointing in a safe direction.

CAUTION: The air used must comply with DIN 3188 (breathing air).

2.3 | LOADING THE ROTARY MAGAZINE

- Put the airgun "ON SAFE" (see chap. 2.1 "Handling the safety").
- Pull back the bolt lever of the rotary magazine retainer slide (see the sequence in illustration 4.a).
- Remove the drum from the airgun (illustration 4.b).
- Load the drum magazine by inserting diabolo pellets in its holes (illustration 3.a).
The diabolo pellets are held in place by an o-ring that traps them.
- Your new airgun has been tested for faults with all the pellets described in the accessories section. Pellets with a maximum total length of 10 mm may be loaded.
- Do not use previously fired or damaged pellets.
- Do not use pointed pellets.

2.4 | LOADING THE RIFLE

- Put the airgun „ON SAFE“ (see chap. 2.1 "Handling the safety").
- Pull back the bolt lever of the rotary magazine retainer slide (see the sequence in illustration 4.a).
- Place the drum in the airgun (illustration 4.b).
- Push the retainer of the drum.
- Push the bolt lever forward and lower it.

WARNING: A diabolo pellet is automatically loaded in the barrel during the locking process.

WARNING: Do not use steel pellets, darts or similar unsuitable ammunition.

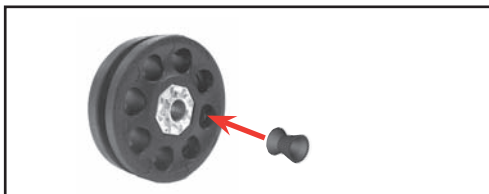

Illustration 3.a

WARNING: Do not put your hand in front of the barrel. Do not put your finger on the trigger.
Caution: Always point the barrel of the airgun in a safe direction. Do not point the airgun at people or animals.

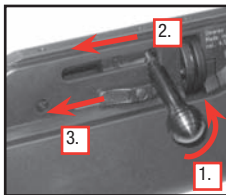

Illustration 4.a

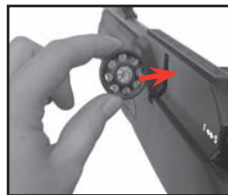

Illustration 4.b

2.5 | UNLOADING THE RIFLE

- Put the airgun „ON SAFE“ as described (see chap. 2.1 "Handling the safety").
- Pull back the bolt lever and then the rotary magazine retainer slide (illustration 4.a) to be able to remove the rotary magazine.
- Remove the rotary magazine (illustration 4.b).
- If there is a pellet in the barrel, remove it with a cleaning brush or proceed as described in chapter "Jams".
- Do not try to shoot a used pellet. It might damage the rotary magazine and the barrel.
- Remove the pellets from the rotary magazine by pressing with a thin, blunt object.
- Make sure the airgun is completely unloaded.
- Put the empty rotary magazine back into the airgun.
- Push the bolt lever forward.
- Push the rotary magazine retainer slide forward.

- Hold the airgun pointing in a safe direction.
- Put the safety "OFF SAFE" and uncock by pulling the trigger and making a blank shot.
- Then engage back the safety.

⚠ WARNING: When removing any pellet from the barrel with a cleaning brush, place the rifle horizontally (see chapter "Jams"). Do not hold the airgun in a vertical position, as the pellet could fall into the mechanism and cause damage.

⚠ WARNING: Never use sharp metal objects to remove pellets from the rotary magazine or the airgun. Any damage to the rotary magazine or the barrel could cause faulty operation.

2.6 | POINT AND SHOOT SAFELY

Make sure the airgun's safety is „ON SAFE“. Insert a compressed air cylinder and load the airgun as described. Make sure that your target is safe before shooting.

⚠ CAUTION: Inspect backstop for wear before and after each use. Discontinue use if backstop shows signs of failure or causes ricochet. Always place backstop in a location that is safe should the backstop fail. Think of what you might hit if you miss the target.

⚠ WARNING: Make sure that the airgun always points in a safe direction. Never point at people or animals. Always handle the airgun as if it were loaded and ready to fire.

⚠ WARNING: Due to this airgun's high shooting capacity, take particular care and caution in choosing a safe target. Only choose targets that cannot be pierced and that do not have a hard surface that can cause ricochets. Never shoot at liquid surfaces.

REPEATING (LOADING PROCESS)

After loading the airgun as described, make sure that the target, the pellet trap and the surrounding area are safe. With each cycling of the bolt lever the magazine rotates one position. Lift the bolt lever, pull rearward and then push forward to its original position (illustration 5.a). Disengage the safety as previously described. Your airgun is ready to fire now.



Illustration 5.a

FIRING CAPACITY

The capacity of the compressed air cylinder and thus the number of remaining shots can be read off the integrated pressure gauge. When the pressure falls to about 40 bars (28-joule and 40-joule variants), refill the cylinder (see chap. 2.2 "Handling the compressed air cylinder").

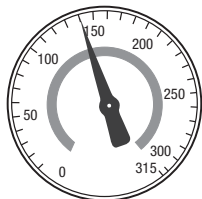

28-joule and 40-joule variants

2.7 | ADJUSTING THE TRIGGER TRAVEL

Activate the safety (put „ON SAFE“).

Unload the airgun as described in point 2.5 "Unloading the rifle".

Adjust your customized trigger travel by using a screwdriver to give a slight turn to the screw on the trigger (illustration 6.a).



Illustration 6.a

2.8 | JAMS

CAUTION: Shooting with insufficient pressure can cause a diabolo pellet to lodge in the barrel.

- Remove the magazine first, then insert a new compressed air cylinder, close the bolt lever and shoot without the rotary magazine into a SAFE TARGET..
- The blocked pellet will fire.
- If this procedure fails to resolve the problem, remove the magazine and carefully press out the blocked pellet with a cleaning brush (cleaning rod) (see illustration 7.a).

WARNING: A jam is a dangerous situation.

WARNING: If the airgun fails to shoot, never assume that there is no ammunition left in the drum rotary magazine.

WARNING: When removing any pellet from the barrel with a cleaning brush, place the rifle horizontally. Do not hold the airgun in a vertical position, as the pellet could fall into the mechanism and cause damage.

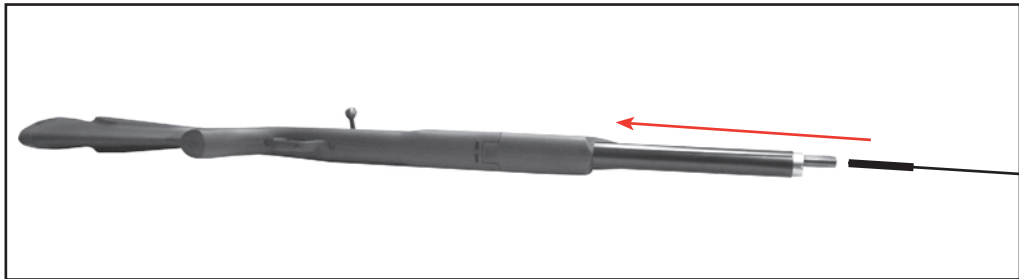

Illustration 7.a

2.9 | ADJUSTING THE SIGHT

Aim at a SAFE target:

Hold the airgun so that the rear sight is lined up with the front sight at the same time. The front sight should be exactly in the center of the notch of the rear sight. Next raise the airgun so that the lower part of the bull's eye meets the front sight. The upper part of the rear sight, the upper part of the front sight and the lower part of the target should be in line (illustration 8.a, sight image). The point of impact can be adjusted as follows. The rifle is adjusted by the factory to shoot from a distance of 10 m.

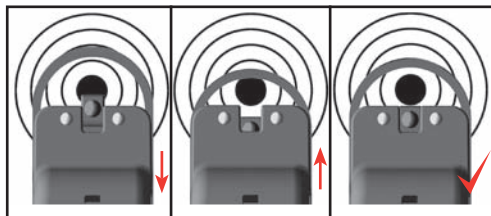

Illustration 8.a too high too low right

To **adjust the elevation** of the sight, move the sight by slightly loosening the screw (illustration 8.b).

With excessively high shots:

Move the sight back.

With excessively low shots:

Move the sight forward.

Then retighten the screw.

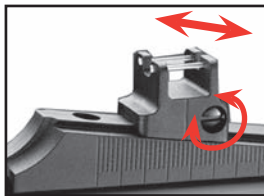

Illustration 8.b

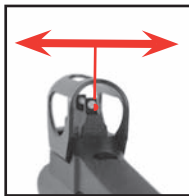

Illustration 8.c

To **adjust the windage** of the sight, it is necessary to move the front sight (Illustration 8.c):

If the airgun shoots to the right:

Move the front sight to the right.

If the airgun shoots to the left:

Move the front sight to the left.

2.10 | STORAGE

Always store the airgun with the ammunition removed and the safety on (ON SAFE). Carefully check that there is no ammunition in the barrel and remove the pellets from the rotary magazine. Before storing it, also remove the compressed air cylinder.

Keep the airgun out of the reach of children and users not familiarized with its use. Store the airgun separately from the pellets and the compressed air cylinder. Always check to make sure the airgun is unloaded when getting it from storage or from another person.

3 | CARE

If you maintain and care for your airgun properly, you will be able to enjoy its use for many years.

Clean the exterior metal parts of the airgun. Use a soft cloth slightly dampened with special oil for airguns. To guarantee lasting operation, apply 2 or 3 drops of RWS Spring Cylinder Oil in the feeder and also in the airgun through the **empty** magazine (see illustration 9.a). Lubricate the rubber ring on the rotary magazine at regular intervals.

Never use cleaning pellets, as they can damage the airgun.



WARNING:

Never leave the airgun loaded.



WARNING:

Do not try to clean the airgun without applying the safety first, removing the compressed air cylinder and the rotary magazine, and making sure there is no pellet in the barrel



Illustration 9.a

4



SAFETY INSTRUCTIONS

		Possible causes						
Problems		Safety activated (ON SAFE)	Cylinder is empty	Dirty barrel	Cylinder not correctly screwed on	High temperatures	Unsuitable ammunition	Pellets incorrectly loaded
The airgun doesn't shoot			●	●		●	●	●
Faulty shooting direction		●	●		●		●	●
Low shooting speed			●	●		●	●	●

INSTRUCTIONS ON THE USE OF COMPRESSED AIR CYLINDERS

Sometimes the performance of an airgun is adversely affected by special factors. Among these conditions we find usage, maintenance and storage at certain temperatures higher or lower than normal outdoors from 60-70° F (15 to 21 °C).

High temperatures can create a pressure in the compressed air cylinder and the airgun itself which considerably exceeds the normal operating pressure. This excessive pressure might prevent firing and cause permanent damage to the airgun. Maximum temperature of storage or operation should never exceed 122° F (50 °C).

Compressed air cylinders which are leaky, damaged or more than 10 years old should be emptied in a safe manner and not used or filled again. Ten years after the manufacturing date, the compressed air cylinder must be tested at the owner's expense or replaced. The manufacturing date is recorded on the cylinder.

The air used must comply with DIN 3188 (breathing air). The maximum operating pressure of the compressed air cylinder (300 bars) must never be exceeded.



WARNING:

Shooting with insufficient pressure can cause a pellet to lodge in the barrel. See the instructions on jams.

MODIFICATIONS IN THE AIRGUN



WARNING:

The different components of this airgun have been designed and manufactured to guarantee optimal function and performance at all times. Any modification in the design or adjustment in the performance may cause malfunction, and with it, the airgun could become unsafe. The warranty shall not be applicable if the rifle has been modified.

SERVICE FOR WALTHER 1250 DOMINATOR

WARNING: An airgun that malfunctions may be dangerous. Therefore, you should store it in a safe place so no one uses it before it is repaired. It is complicated to repair an airgun on your own. In addition, incorrect assembly can lead to dangerous malfunctions.

WARRANTY FOR WALTHER 1250 DOMINATOR

ONE YEAR LIMITED WARRANTY

This product is warranted to the retail consumer for one (1) year from date of purchase against defects in material and workmanship and is not transferable.

WHAT IS COVERED

Replacement parts and labor.

WHAT IS NOT COVERED

Shipping charges to Umarex USA for defective product and damages caused by abuse or failure to perform normal maintenance as well as any other expense. Consequential damages, or incidental expenses, including damage to property. Some states do not allow the exclusion or limitation of incidental or consequential damages, so the above limitation or exclusion may not apply to you.

WARRANTY CLAIMS

Warranty Claims and Repair for U.S. and Canadian customers only. Call Umarex USA (479)-646-4210 and ask for the Service Department. If it is determined a return is necessary, you will be issued a Return Authorization Number.

Write this number boldly on the box and return the product prepaid to Umarex USA.

Your name, address, phone number and a note explaining the defect found must be included in the package. A copy of the original purchase receipt must accompany the return. Include a check made to Umarex USA in the amount of \$21.95 to cover shipping and handling.

IMPLIED WARRANTIES

Any implied warranties, including the implied warranties of merchantability and fitness for a particular purpose, are limited in duration to 1 year from date of retail purchase. **SOME STATES DO NOT ALLOW LIMITATIONS ON HOW LONG AN IMPLIED WARRANTY LASTS, SO THE ABOVE LIMITATIONS MAY NOT APPLY TO YOU. TO THE EXTENT ANY PROVISION OF THIS WARRANTY IS PROHIBITED BY FEDERAL STATE, OR MUNICIPAL LAW WHICH CANNOT BE PREEMPTED, IT SHALL NOT BE APPLICABLE. THIS WARRANTY GIVES YOU SPECIFIC LEGAL RIGHTS, AND YOU MAY ALSO HAVE OTHER RIGHTS WHICH VARY FROM STATE TO STATE AND COUNTRY TO COUNTRY.**



WARNING:

Make sure the rifle is examined and repaired only by authorized, specialized personnel or by a gunsmith.



IMPORTANT:

Before transporting your gun, make sure the safety is „ON SAFE“ and the air cylinder has been removed.

SAFE GUN HANDLING

You should be familiar with the safe and proper handling of your airgun. Because your new airgun has a high shooting capacity, careful attention is advised. Regarding the basic rules to shoot safely, consider every contact you have with your airgun as part of its handling.

- Deactivate the airgun safety only when you are ready to shoot, and when you are done, activate it again immediately.
- Always handle the airgun as if it were loaded.
- Always apply the safety before loading, to ensure that no involuntary shots are made. Only put your finger on the trigger and pull it when you are going to shoot.
- Use only ammunition and compressed air cylinders designed for this airgun.
- Always keep the barrel of the rifle pointed in a safe direction.
- Keep in mind the maximum range of the pellet (approximately 625 yards, or 571 meters).
- Never transport the airgun when it is loaded. Only load it when you intend to shoot it.
- Never point the airgun at people or animals. Avoid shots where the ammunition could ricochet. Do not aim at hard, smooth objects or water. Pellets could ricochet.
- Before shooting, make sure the target and your surroundings are secure.
- Always confirm that the airgun is not loaded and that the safety is on when you carry it or give it to another person.
- Make sure the area toward which you are pointing the airgun is safe, including if you were to trip or the airgun were to fall.
- For safety reasons, wear protective glasses when you shoot.
- Always store the airgun unloaded, with the safety on. Keep the ammunition and the compressed air cylinder out of reach of unauthorized persons (those who have not been instructed on its use, children, persons under 18). Store ammunition separately.
- Give this airgun along with usage instructions only to those over 18, and make sure that they are as familiar as possible with its handling. In Germany an Airguns Possession Card (WBK) is required for versions above 7.5 joules muzzle energy.
- Any modification or repair of the airgun should be carried out by Umarex USA or their authorized repair facilities.
- Never leave the airgun loaded if it is out of your reach.
- Unload the airgun before giving it to someone else.

TECHNICAL DATA

	28 joules	40 joules
Caliber	4.5 mm (.177)	5.5 mm (0.22)
Magazine capacity	8 shots	
Length	40.94 in	
Weight	91.71 oz, 5.73 lbs.	
Muzzle speed (energy)	Up to 1200 fps	Up to 1000fps
Barrel length	23.62 in	
Action	compressed air	
Safety	Automatic	

CAUTION: Umarex USA air guns are made according to the regulations of the PTB (Physikalisch-Technischer Bundesanstalt) federal institute, German federal law, the regulations established in the CIP center and the broad experience in arms manufacture of Umarex USA.

Therefore, we assume no liability if our products fail to meet the corresponding legal regulations when exported, or if the purchaser or owner might have legal difficulties or consequences in this respect.

ACCESSORIES FOR WALTHER 1250 DOMINATOR



Rotary clips

pack of 2 pcs.,
also suitable for pointed pellets

Item No. 465.102



Silencer / Compensator

Simple bolt-fixing assembly. Reduces
detonation at muzzle when shooting.
(Consult the corresponding legislation).

Silencer	Item No. 465.105
Compensator	Item No. 465.106



Picatinny Rail

easy to assemble to existing system

Item No. 2.1525



Steel compressed air cylinder 300 bar

267 cm, 930 g,
with pressure gauge
and Quick-Fill adapter

Item No. 465.108

1250 ✓ DOMINATOR



WALTHER

Distributed by / Distribué par:

UMAREXUSA®

www.UmarexUSA.com

6007 South 29th Street

Fort Smith, AR 72908

Phone: 479-646-4210

Fax: 479-646-4206

8.465.84.01 | 11-07