

Friedrich®



(D40 / D50 Only)

Installation & Operation Guide

DEHUMIDIFIER MODELS

115 Volts • D30 • D40 • D50

Register Your Dehumidifier

Model information can be found on the name plate on the rear of the unit behind the condensate bucket.

To register your dehumidifier, complete and mail the enclosed registration card. or register on-line at www.friedrich.com (USA only). For your future convenience, record the model information here.

MODEL NUMBER

SERIAL NUMBER

PURCHASE DATE

Safety Precautions.....3

Operating Instructions.....5

Installation Instructions.....8

Care and Maintenance9

Troubleshooting Tips..... 10

Warranty.....Back cover

Customer Assistance NumbersBack cover



READ THIS MANUAL

Inside you will find many helpful hints on how to use and maintain your dehumidifier properly. Just a little preventive care on your part can save you a great deal of time and money over the life of your dehumidifier.

You'll find many answers to common problems in the chart of Troubleshooting Tips. If you review our chart of Troubleshooting Tips first, you may not need to call for service at all.



PRECAUTION

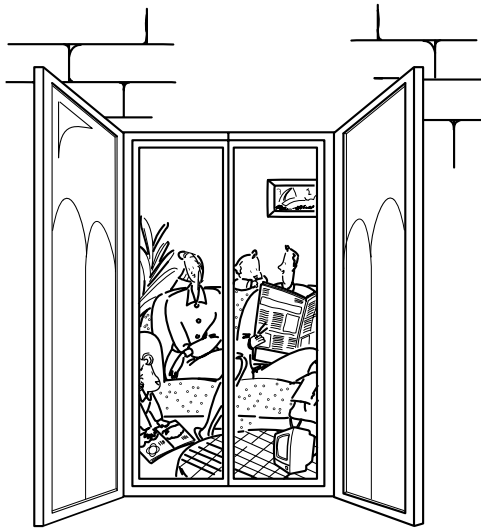

- Contact an Authorized Service Center for repair or maintenance of this unit.
- The dehumidifier is not intended for use by young children or invalids without supervision.
- Young children should be supervised to ensure that they do not play with the dehumidifier.





Safety Precautions

Read all instruction before using.

- To prevent property damage or injury to the user or others, the following instructions must be followed.
- Incorrect operation due to ignoring instructions will cause harm or damage; the seriousness is classified by the following indications.

	WARNING	This symbol indicates the possibility of death or serious injury.
	CAUTION	This symbol indicates the possibility of injury or damage to properties only.

- Meanings of symbols used in this manual are as shown below.

	Never do this.
	Always do this.

WARNING

Complete all grounding and installation requirements as described on page 5.

- It could cause electrical shock or fire.

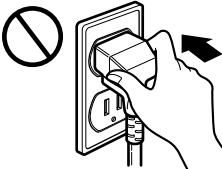

Disconnect power cord from receptacle before servicing or cleaning.

- It could cause electrical shock or fire.

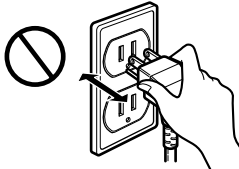

Do not use flammable fluids, solvents, abrasive cleaners, or strong detergents to clean the dehumidifier.

- It could cause fire or product damage hazard.



Do not plug the dehumidifier in until the outside of unit is completely dry.

- It could cause electrical shock and personal injury hazard.

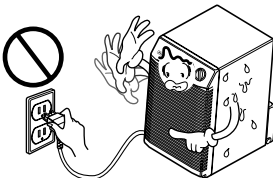

Do not use the water collected in the bucket for drinking purposes.

- It is not sanitary and could cause illness or personal injury hazard.

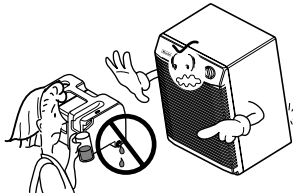

Do not clean the dehumidifier while it is plugged in.

- It may cause electrical shock.

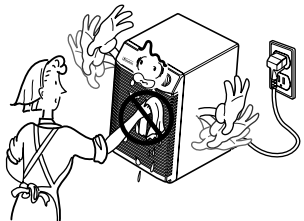

CAUTION

Be sure to block the wheels to prevent unit from falling when installed on a table or shelf.

- It may damage the dehumidifier or cause other damage or injury.

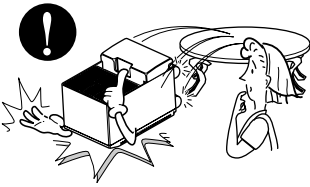

Be sure to replace bucket properly after emptying to prevent water from collecting on the floor.

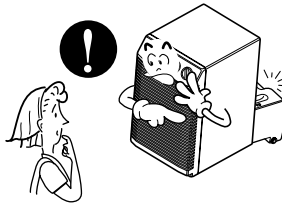

Make sure the dehumidifier is the correct size for the area you want to dehumidify.

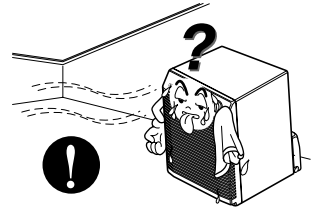

Do not operate switches with wet hands.

- It may cause electrical shock.

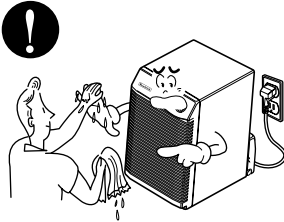

Install the dehumidifier properly on a floor, table, or shelf that is level and strong enough to support it with a full bucket of water.

- It should withstand around 90 lbs (40kg) of weight.

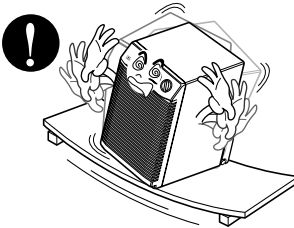

Do not install dehumidifier in an area where temperatures will fall below 65°F (18°C.)

- Low temperatures could cause coils to frost and unit may not start.

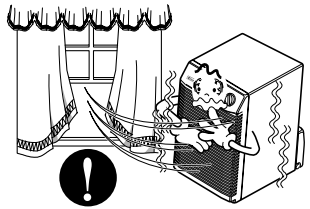

Close all doors, windows and other outside openings to the room.

- The dehumidifier must be operated in an enclosed area to be most effective.

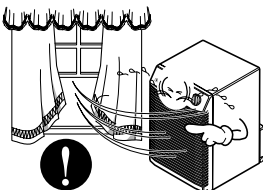

Do not put a pet or house plant where it will be exposed to direct air flow.

- This may injure the pet or plant.

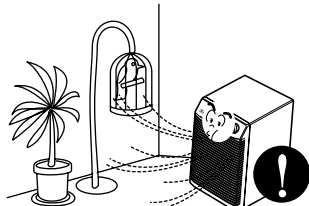

Operating Instructions

Features

This section contains captioned illustrations of your dehumidifier. Use the drawings to become familiar with all parts and features and what they look like.

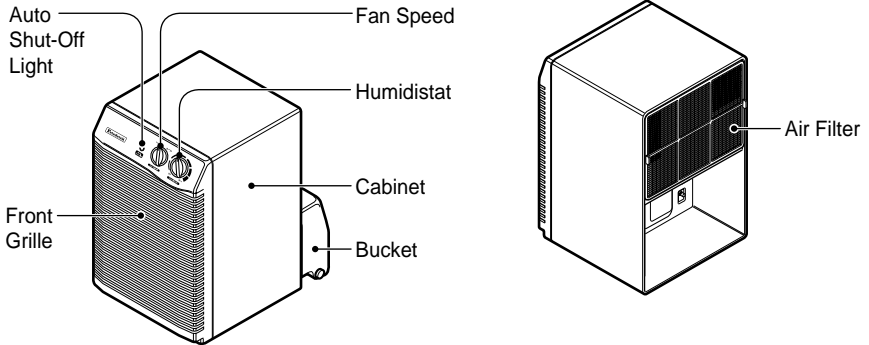

Electrical requirements

OBSERVE ALL LOCAL CODES AND ORDINANCES. DO NOT, UNDER ANY CIRCUMSTANCES, REMOVE THE POWER SUPPLY CORD GROUND PRONG.

Electrical ground is required on this appliance.

A 115-volt 60 Hz, AC only, 15A fused and properly grounded electrical supply is required. A time delay fuse or time delay circuit breaker is required.

Use a dedicated circuit, serving only this appliance. Do not use an extension cord.

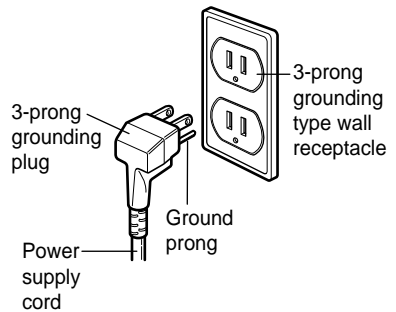

Recommended grounding method

For your personal safety, this appliance must be grounded. This appliance has a power supply cord with a 3-prong grounding plug. To minimize possible shock hazard, the cord must be plugged into a mating grounding type wall receptacle, grounded in accordance with the latest edition of the National Electrical Code (ANSI/NFPA 70) and all local codes and ordinances. If a mating wall receptacle is not available, it is the personal responsibility and obligation of the customer to have a properly grounded 3-prong wall receptacle installed by a qualified electrician.

Operating your dehumidifier

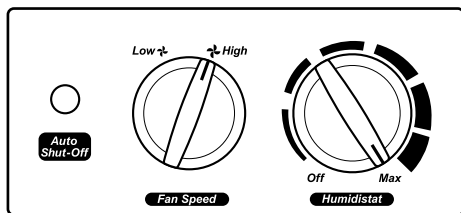
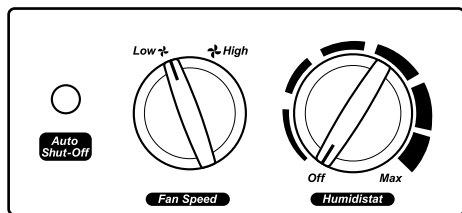

Control

Your dehumidifier has a control panel containing an indicator and two controls — Auto Shut-Off, Fan Speed, and Humidistat.

Auto Shut-Off --- This lamp glows when the bucket is full or is missing.

Fan Speed --- This controls the speed of the airflow.

Humidistat --- This controls the moisture in the room.

Unit operation

1. Turn the Humidistat to **Off**. Plug the power supply cord into an electrical outlet.
2. The Humidistat can be set anywhere between **Off** and **Max** for normal operation. If you need more dehumidification, turn the Humidistat toward **Max**. If you need less dehumidification, turn the Humidistat toward **Off**.
3. Turn the Humidistat to **Off** to stop the unit.
4. If you want to control the speed of air flow, turn the Fan Speed toward **Low** or **High**.

NOTE: The Fan and compressor will not operate for about two minutes to protect the compressor when you turn the unit off and immediately back on.

De-icer control (invisible)

The Defrost Control senses frost build-up on the evaporator coil and automatically shuts off the compressor. The fan continues to run, drawing air across the coil, and melting the frost. When the coil is defrosted, the compressor automatically restarts, and dehumidifying resumes.

NOTE: Do not operate the dehumidifier at temperature below 65°F (18°C.) If your dehumidifier runs when the temperature and humidity conditions of room are low, frost can form on its evaporator coil. This interferes with proper operation. Therefore, dehumidifying performance may be reduced.

Automatic shut off

The dehumidifier will turn off automatically when the bucket is full, removed or not replaced in the proper position.

The bucket must be replaced in the proper position for the dehumidifier to work. The light will be on and the dehumidifier will not run if the bucket is not in the proper position.

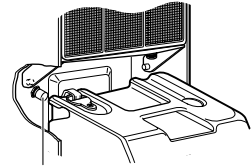

Water level control switch

Disposing of collected water (3 methods)

1. Empty the bucket manually.

When the bucket is full, pull out and empty it into a large sink or tub and then replace it properly.

NOTE: The bucket must be positioned properly making sure slots on the back of bucket are positioned correctly.

NOTE: Do not overtighten the hose when connecting it to the bucket. Use a rubber washer and tighten by hand firmly without stripping the plastic threads.

2. Place the dehumidifier directly over drain.

The bucket has a threaded hose connection which can be left open. Drill a 1/4" (6.4 mm) hole in the center of the hose connection. Once opened, the hose connection will continually drain water from the bucket.

NOTE: The nozzle cannot be fixed after puncture. Use an ordinary garden hose cap to reclose if necessary.

3. Attach a length of garden hose to the threaded bucket drain hose connection to carry water to the drain.

When being attached to the bucket drain hose connection, be sure the hose doesn't kink or bend. It should lie flat from the dehumidifier to the drain.

NOTE: The hose attachment will accept a standard garden hose filling. You can attach a screw-on cap to use the bucket without a hose.

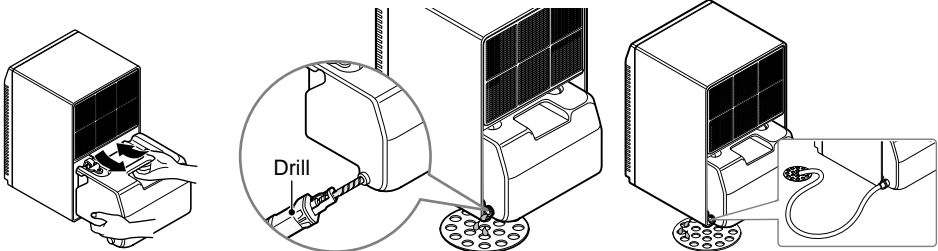

Installation Instructions

Installing the dehumidifier properly

1. Allow at least 12 inches of space on all sides of the unit for good air circulation.
2. Install your dehumidifier on a floor, table, or shelf. When installing the dehumidifier on a table or shelf, make sure the table or shelf is strong enough to support the weight of the dehumidifier with a full bucket. Do not sit or stand on the dehumidifier.
NOTE: The height of a table or shelf might provide a better position from which to handle the bucket and help prevent icing of the coils due to colder air near the floor (such as in a basement.)
3. Lift the bucket and place it in the dehumidifier, making sure the slots on both sides of the bucket are positioned correctly.
4. Rollers let you move the dehumidifier easily.

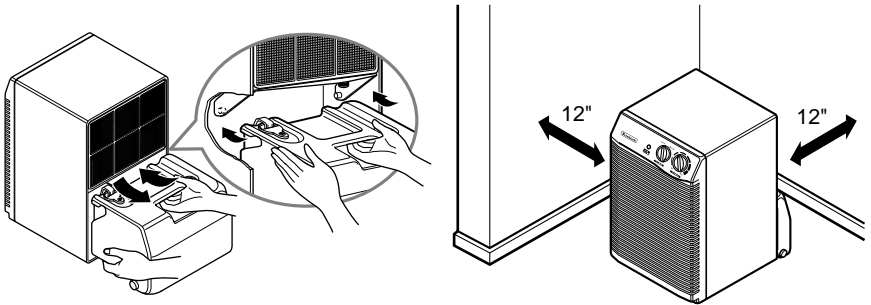

Choosing the proper location for your dehumidifier

- Use the dehumidifier in a basement to help prevent moisture damage.
- Use the dehumidifier in laundry drying, bathing, and dishwashing areas which have excessive moisture.
- Use the dehumidifier to prevent moisture damage anywhere books are stored.

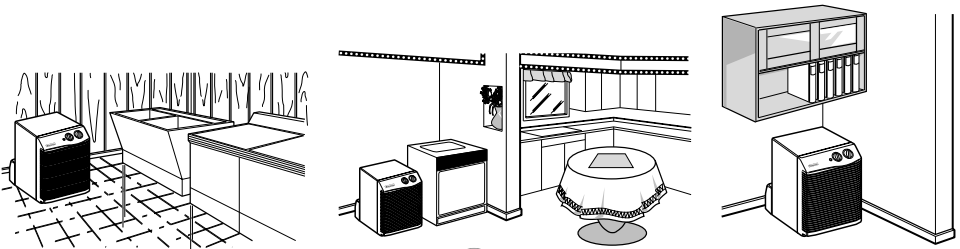

Care and Maintenance

Your dehumidifier is designed to serve you year-round. It needs practically no attention. However, you should check your dehumidifier and inspect the coils annually.

You may want an Authorized Service Center to perform this annual checkup. (Cost of the inspection is the owner's responsibility.)

OR

If you are familiar with electrical appliances and their functions, listed below are instructions which would allow you to perform the inspection and maintenance for yourself.

Cleaning the front grille and case

Clean the front grille and the cabinet with a soft cloth, warm water, and a mild detergent.

Do not use bleach or abrasives.

Cleaning the air filter

1-1. First, flex the filter at the lower right corner. Second, slide the upper right side to the left. Then, release all of the tabs and remove the filter.

1-2. Wash air filter with warm water and a mild detergent. Rinse and dry it.
Replace dry air filter.

Cleaning the coil

2-1. Remove air filter from the cabinet (see step 1 above).

2-2. Brush the coil gently like arrow in the figure, if necessary, with warm water and a mild detergent. Rinse and dry them thoroughly.

Be careful not to spray the coil with a water hose.

Be careful! Sharp edges!

⚠ WARNING

Electrical Shock Hazard

- Disconnect power supply cord from receptacle before performing any maintenance.
- Be careful when cleaning the coils. Fins are sharp.

Failure to follow the above precautions could result in electrical shock or personal injury.

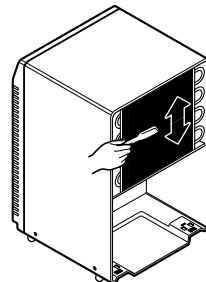
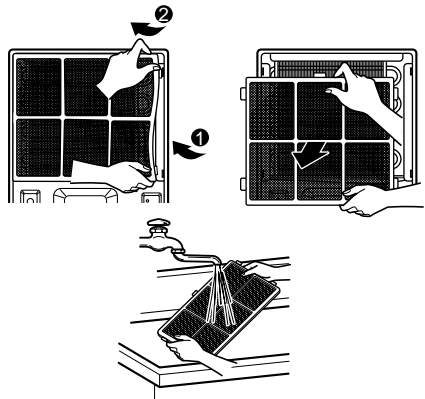
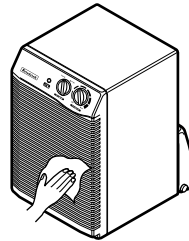

Troubleshooting Tips

Before you call for service, review this list. It may save time and money.

The list includes common occurrences that are not the result of defective workmanship or materials in this appliance.

FIND YOUR PROBLEM HERE	POSSIBLE CAUSES	WHAT TO DO
DEHUMIDIFIER DOES NOT OPERATE	Plug is disconnected from outlet.	Push plug firmly into wall outlet.
	The fuse is blown/circuit breaker is tripped.	Check the house fuse/circuit breaker box and replace fuse or reset the breaker.
	The dryness level you selected has been reached.	Dehumidifier automatically shuts off when the selected amount of moisture has been removed from the air. If you want to remove more moisture, turn the Humidistat to Max . After the dehumidifier starts, reset the control to the desired setting.
	The Auto Shut-Off light is on.	Dehumidifier automatically shuts off when the bucket is full. Empty the bucket and replace.
	Dehumidifier is not turned on.	Turn on the Humidistat.
DEHUMIDIFIER RUNS TOO MUCH	Humidistat is set too high.	Turn the Humidistat to a lower setting. Close all windows or doors to outside.
	Windows or doors near dehumidifier are open to outdoors.	Check with your dealer to see if capacity is adequate.
	Area to be dehumidified is too large.	Front grille may be dirty.
	Air movement through dehumidifier is blocked.	Use a soft cloth, warm water, and a mild detergent to clean the grille. Dehumidifier's coils on the back of unit may be dirty. Clean the soil on the coils on the back of the unit. Dehumidifier must be placed in a space that does not restrict air flowing into the rear coil or out of the front grille. Dehumidifier will not turn off if Humidistat is at Max .
	Humidistat is set at Max .	Frost will usually disappear within 60 minutes.
FROST APPEARS ON COILS	Room temperature is too low. Room temperature is below 65°F (18°C.)	
FAN NOISE	Air is moving through the dehumidifier.	This is a normal sound.

**DEHUMIDIFIER DOES NOT
DRY THE AIR AS IT SHOULD**

Dehumidifier has been installed or restarted recently.	<ul style="list-style-type: none">• The more moisture in the room air, the longer it takes for the room air to become dry.
Airflow is restricted.	<ul style="list-style-type: none">• Make sure there are no curtains, blinds, or furniture blocking the front or back of the dehumidifier.
The control may not be set high enough.	<ul style="list-style-type: none">• Turn the knob to a higher number.
Doors and windows may not be closed tightly.	<ul style="list-style-type: none">• Check that all doors, windows, and other openings are securely close.
Clothes dryer may be blowing moisture-laden air into the room.	<ul style="list-style-type: none">• Install the dehumidifier away from the dryer. Dryer should be vented to the outside.
Room temperature is too low.	<ul style="list-style-type: none">• The unit will not effectively operate satisfactorily if the room temperature is below 65°F (18°C.)



FRIEDRICH AIR CONDITIONING CO.INC.

Post Office Box 1540 ¥ San antonio, Texas 78295-1540
4200 N. Pan Am Expressway ¥ San Antonio, Texas 78218-5212
(210) 357-4400 ¥ FAX (210) 357-4480
Visit us on the Internet at www.friedrich.com

**DEHUMIDIFIERS
LIMITED WARRANTY**

FIRST YEAR

ANY PART: If any part supplied by FRIEDRICH fails because of a defect in workmanship or material within twelve months from date of original purchase, FRIEDRICH will repair the product at no charge, provided the product is transported to a Friedrich Authorized Service Center for repair. ALL transportation charges are the sole responsibility of the owner. This remedy is expressly agreed to be the exclusive remedy within twelve months from the date of the original purchase.

SECOND THROUGH FIFTH YEAR

SEALED REFRIGERANT SYSTEM: If the Sealed Refrigeration System (defined for this purpose as the compressor, condenser coil, dehumidifying coil, capillary, filter drier, and all interconnecting tubing) supplied by FRIEDRICH in your dehumidifier fails because of a defect in workmanship or material within sixty months from date of purchase, FRIEDRICH will pay a labor allowance and parts necessary to repair the Sealed Refrigeration System; **PROVIDED** FRIEDRICH will not pay the cost of diagnosis of the problem, removal, freight charges, and transportation of the dehumidifier to and from the Service Agency, and the reinstallation charges associated with repair of the Sealed Refrigeration System. All such cost will be the sole responsibility of the owner. This remedy is expressly agreed to be the exclusive remedy within sixty months from the date of the original purchase.

APPLICABILITY AND LIMITATIONS: This warranty is applicable only to units retained within the Fifty States of the U.S.A., District of Columbia, and Canada. This warranty is not applicable to:

1. Air filters or fuses.
2. Products on which the model and serial numbers have been removed.
3. Products which have defects or damage which results from improper installation, wiring, electrical current characteristics, or maintenance; or caused by accident, misuse or abuse, fire, flood, alterations and/or misapplication of the product and/or units installed in a corrosive atmosphere, default or delay in performance caused by war, government restrictions or restraints, strikes, material shortages beyond the control of FRIEDRICH, or acts of God.

OBTAINING WARRANTY PERFORMANCE: Service will be provided by the FRIEDRICH Authorized Dealer or Service Organization in your area. They are listed in the Yellow Pages. If assistance is required in obtaining warranty performance, write to: Room Air Conditioner Service Manager, Friedrich Air Conditioning Co., P.O. Box 1540, San Antonio, TX 78295-1540.

LIMITATIONS: THIS WARRANTY IS GIVEN IN LIEU OF ALL OTHER WARRANTIES. Anything in the warranty notwithstanding, ANY IMPLIED WARRANTIES OF FITNESS FOR PARTICULAR PURPOSE AND/OR MERCHANTABILITY SHALL BE LIMITED TO THE DURATION OF THIS EXPRESS WARRANTY. MANUFACTURER EXPRESSLY DISCLAIMS AND EXCLUDES ANY LIABILITY FOR CONSEQUENTIAL OR INCIDENTAL DAMAGE FOR BREACH OF ANY EXPRESSED OR IMPLIED WARRANTY.

NOTE: Some states do not allow limitations on how long an implied warranty lasts, or do not allow the limitation or exclusion of consequential or incidental damages, so the foregoing exclusions and limitations may not apply to you.

OTHER: This warranty gives you specific legal rights, and you may also have other rights which vary from state to state.

PROOF OF PURCHASE: Owner must provide proof of purchase in order to receive any warranty related services.

All service calls for explaining the operation of this product will be the sole responsibility of the consumer.

All warranty service must be provided by an **Authorized FRIEDRICH Service Agency**, unless authorized by FRIEDRICH prior to repairs being made.

Revised (01/02)