

DAEWOO

DEHUMIDIFIER

USE & CARE MANUAL

MODEL #: DHC-250
DHC-400
DHC-600



Please read carefully and thoroughly this manual before operating the unit.
If you still have any difficulties or problems, consult your dealer for help or **DAEWOO** ELECTRONICS.
Please keep this manual well.

W1

CONTENTS

FUNCTIONS.....	1
SAFETY NOTES.....	1
NAMES OF PARTS.....	2
CONTROL PANEL.....	2
TECHNICAL SPECIFICATIONS.....	3
INSTALLATION.....	3
OPERATING INSTRUCTIONS.....	4
OPERATION.....	4
MAINTENANCE	5
TROUBLE SHOOTING.....	7



ATTENTION

Before you use your **DE-HUMIDIFIER**, please read this instruction manual carefully.

FUNCTIONS

1. Helps prevent mould on clothing, etc-open cupboards, doors and drawers before turning the dehumidifier on.
2. Helps prevent condensation on ceiling, walls, glazing-to obtain best results refrain from opening and closing the windows.
3. Dehumidifying is effective on moisture sensitive items like musical instruments, cameras, computers, etc.
4. Takes away the dampness from bookshelves and closets - open the door of the closet and put the dehumidifier close to the door for it to operate effectively.

SAFETY NOTES

1. Do not connect unit to any AC electrical socket that is damaged.
2. Ensure removable covers and containers are correctly fitted before switching on unit.
3. Always switch off at the socket-outlet when not in use and before unplugging.
4. Do not use in the following locations:
 - I. Next to source of heat e.g. a radiator or heater, tumble dryer etc.
 - II. An area where oil or water is likely to splash.
 - III. An area exposed to direct sunlight.
 - IV. Near a bath, shower or a swimming pool.
 - V. In a greenhouse.
5. Never insert your finger or other foreign objects into grills or openings. Take special care to warn children of these dangers.
6. Always store the unit upright in order to maintain the compressor in a proper working condition. Leave the unit upright for at least 24 hours before operating.
7. Always unplug the unit before cleaning.
8. Do not cover the unit.
9. Do not spray insecticides or any other flammable sprays on the machine.
10. Do not spray water on the dehumidifier.
11. There are no user serviceable parts, should the unit or supply cord of this appliance become damaged, the unit must be returned to the manufacturer or service agent.
12. Empty the water tank before moving the dehumidifier.
13. The unit is fitted with an auto defrosting operation and starts when the evaporator generates frost. This function ensures continuous running when the temperature is down to 13°C.

NAMES OF PARTS

Control Panel

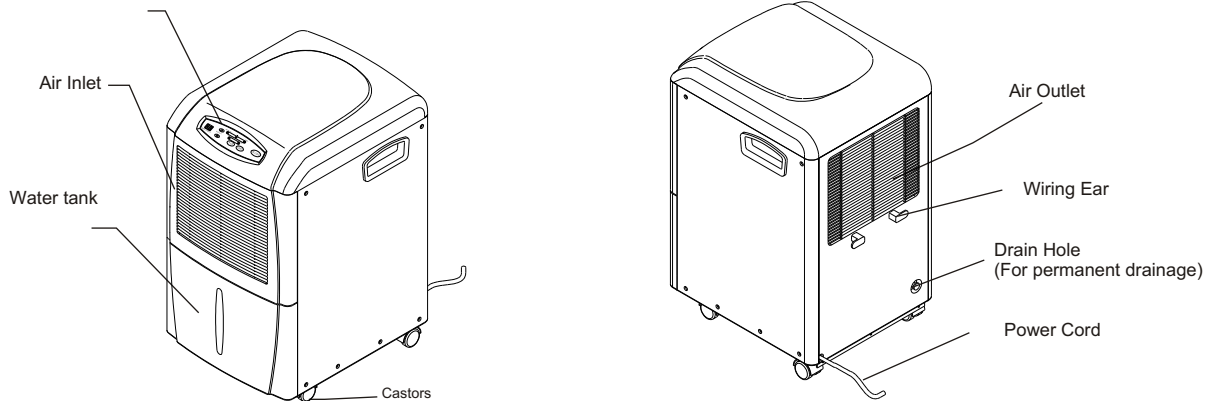

CONTROL PANEL

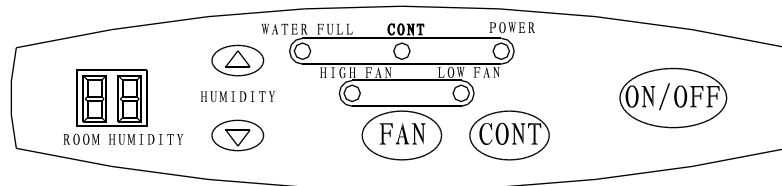

- ❶ **ON/OFF Button:** When the unit is connected to the power(initial power), the POWER indicator will flash slowly. Press the ON/OFF button at this time, the unit will directly go into DEHUMIDIFYING operation with the original factory humidity setting(60%RH). Press the ON/OFF button again, the unit will stop operation.
- ❷ **CONT Button:** When the unit is in operation, press the CONT Button will go into CONTINUOUS DEHUMIDIFYING mode.
- ❸ **FAN Button:** By pressing the FAN button, the fan speed will change in sequence below: HIGH FAN-----LOW FAN-----HIGH FAN.
- ❹ **POWER indicator:** At the first time to connect to the power, it flashes slowly The POWER indicator lights when the unit is turned on, and dark when the unit is turned off.
- ❺ **CONT indicator:** Lights when the unit is on CONTINUOUS DEHUMIDIFYING mode.
- ❻ **WATER FULL indicator:** Lights when the bucket is full, and the unit stops operating.
- ❼ **HUMIDITY \triangle Button:** When the unit is in operation, the setting humidity will go up by pressing this button every time, the range of adjustment is from 35%RH to 80% RH.
- ❽ **HUMIDITY ∇ Button:** When the unit is in operation, the setting humidity will come down by pressing this button every time, the range of adjustment is from 80%RH to 35%RH.
- ❾ **HIGH FAN indicator:** Lights up when HIGH FAN speed is selected.
- ❿ **LOW FAN indicator:** Lights up when LOW FAN speed is selected.

TECHNICAL SPECIFICATIONS

Model	DHC-250	DHC-400	DHC-600
Dehumidifying capacity	12L/d(25pints/d)	21L/d(45pints/d)	28L/d(60pints/d)
Power supply	115V~ 60Hz		
Current	3.9A	4.5A	6.3A
Power consumption	350W	510W	730W
Working Environment	13~35°C		
	25% RH and above		
Water tank volume	8L(17pints)		
Net weight	53LBS		55LBS
Dimension	W(13.8") x H(25") x D(16.7"), INCH		

※ Capacity will vary according to actual room ambient temperature and humidity conditions.

INSTALLATION

Install the mobile dehumidifier in a flat and spacious location where the air outlets will not be covered up. Do not install underneath desks or inside cupboards as this will restrict the air flow.

Maintain a clearance of at least 20cm front and rear to maintain correct air-flow of unit.

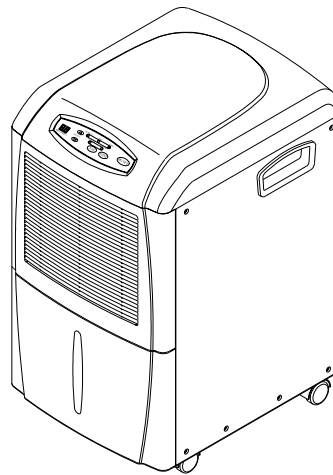





OPERATING INSTRUCTIONS

Operating Conditions:

- This unit is designed to operate with a working environment between 13°C and 35°C.
- If the unit has been switched off and needs to be switched on again quickly, allow approximately three minutes for the correct operation to resume.
- Do not connect the dehumidifier to a multiple socket outlet, which is also being used for other electrical appliances.
- Select a suitable location, making sure you have easy access to an electrical outlet.
- Plug the unit into a 115V~ 60Hz electrical socket-outlet with earth connection.
- Make sure the Water Tank is correctly fitted otherwise the unit will not operate properly.

Turning the unit “ON” or “OFF”

1. Plug the cord to the proper power requirement. The computer system of the unit will have a self-check. If it is normal, the POWER indicator flashes at 0.5Hz. Press ON/OFF button now, the unit will start operating under DEHUMIDIFYING mode with 60% setting humidity. Press the HUMIDITY  or  button will change setting humidity.
2. Press the CONTINUE button will go into continues dehumidifying mode, and this time the HUMIDITY  and  button are disable.
3. Press the ON/OFF button to turn off the unit. (You do not need to unplug the power cord except when the unit will not be in use for a long period of time.)

OPERATION

Water Tank

- Water will drain into the tank. When the tank is full and the unit stops operating, the Water Full indicator light will flash.
- Do not remove the water tank whilst the machine is still working or just stopping. This might cause some water to drip.
- To empty the water tank, remove the tank as shown, empty the water and replace the tank back in the unit. Ensure components of water tank are correctly positioned.
- The machine will re-start when the water tank is restored in its correct position.

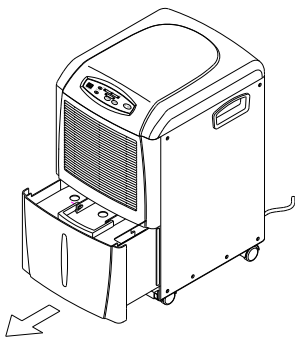

1. Drag out the bucket a little.

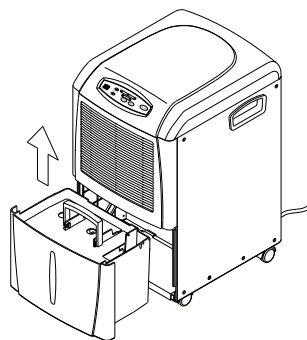

2. Hold the two sides of the bucket with even strength, and pull it out from the unit.

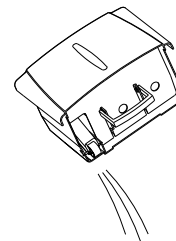

3. Pour the water out.

Continuous drainage

- On the rear of the unit, remove the drain plug carefully (see picture below).
- Push the hose onto the connector located inside of the hole.
- The hose should go down smoothly without bends or kinks.
- Place the end of the hose into a suitable drainage facility.

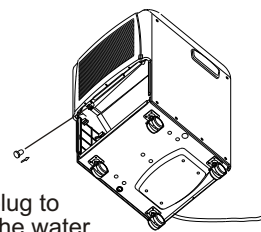
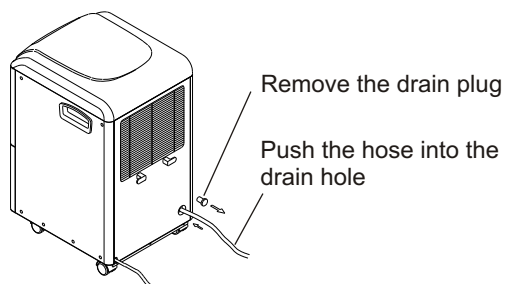

Note: Make sure the drain plug is completely inserted.

MAINTENANCE

Important:

- Be sure to unplug the unit before cleaning.
- Do not use petrol, thinners or other chemical agents to clean the unit as this may damage the unit.
- Do not wash the unit directly under a tap or hose. The electrical components inside may be damaged and the unit become unsafe as a result.

Air filter

Clean the air filter at least once every two weeks to prevent impaired performance of the unit.

Removal

Pull the water tank out as shown (Figure A), and pull the Air Filter down as shown (Figure B).

Cleaning

Wash the air filter with clean water, and then carefully dry.

Replacement

Install the cleaned Filter following Figure C, and replace the water tank in the unit.

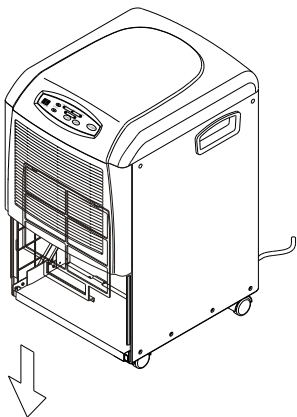

Fig. A

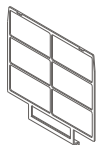

Fig. B

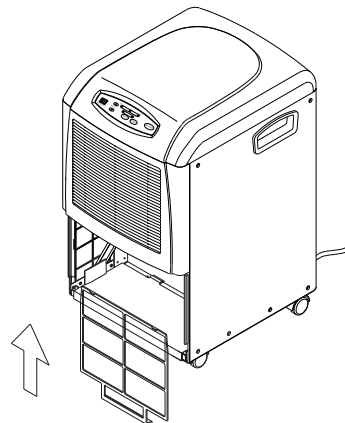

Fig. C

Unit enclosure

Use a soft, clean cloth to wipe the surface. Do not use water as this may cause an electrical fault or shock hazard.

Water tank

Wash the tank using warm water (about 40°C) with neutral detergent. Rinse and allow to dry. Replace tank when dry.

TROUBLE SHOOTING

BEFORE CONTACTING THE MANUFACTURER OR HIS AGENT, PLEASE CHECK THE FOLLOWING POSSIBILITIES.

PROBLEM	POSSIBLE CAUSE	CORRECTIVE ACTION
Unit fails to operate	1. Power “off”	Switch power “on”
	2. Power cord “unplugged”	Restore power cord
	3. Water tank not fitted correctly	Re-position water tank
	4. Water tank is “full”	Empty water tank
	5. Defrosting	After defrosting, the unit will dehumidifying again.
Performance decreased	1. Blocked air filter	Wash nylon filter
	2. Room windows and doors open	Close room windows and doors
	3. Obstacles in air outlet or air inlet	Remove obstacles
Unit noisy	1. Unstable setting of unit	Reposition unit
	2. Blocked filter	Wash nylon filter

Limited Warranty

DAEWOO

DAEWOO ELECTRONICS AMERICA, INC. warrants the following Dehumidifier to be free from defective material and workmanship and agrees to remedy any such defect or to furnish a new part (at the Company's option) in exchange for any part of any unit of its manufacture which under normal installation, use and service disclosed such defect, provided the unit is delivered by the owner to store or dealer where purchased or Daewoo authorized service center. To establish and receive warranty service at our store, dealer or our authorized service center, a sales receipt or bill of sales is required for proof of purchase.

This warranty does not extend to any of our electronic products which have been subjected to misuse, neglect, accident, incorrect wiring not our own, improper installation, unauthorized modification, or to use in violation of instructions furnished by us, nor units which have been repaired or altered outside of our factory, nor to cases where the serial number thereof has been removed, defaced, or changed.

This warranty is in lieu of all warranties expressed or implied and no representative or person is authorized to assume for us any other liability in connection with the sales of our electronic products.

Over the counter exchange for units that are initially defective. Initial defective is described as when the dealer opens the unit and finds that it is inoperative or an individual customer opening a new unit and finding that it is initially defective. This unit may be returned to the factory by the dealer for exchange. Under no circumstances will an individual customer be permitted to return defective unit directly to factory. Exchange must be directly with the dealer. When this unit is returned to dealer, a copy of the purchase evidence stating the date of purchase is to be put in the individual box for dealer's further control with the factory.

<u>MODEL</u>	<u>PARTS</u>	<u>LABOR</u>	<u>COMPRESSOR</u>
DHC-250			
DHC-400	1 year	1 year	5 years
DHC-600			

Note: The warranty service center list is constantly changing with the addition of our current qualified service centers. If there is inadequate or no local service facility, subject individual customer will call DAEWOO on the toll free number **1-800-DAEWOO8(1-800-323-9668)** to be provided with further informations.