



MS75

750mm Electric Built-in Oven
USER MANUAL

Euromaid

price, quality, performance

Contents

NOTE: Some sections throughout this manual may not be relevant to your oven as it is also used for other countries outside Australia

Conditions of use	3
Safety precautions	3
Other important safety information	3
Warnings for use of grill and oven	4
Disposal of packaging	4
Close-up view	5
Using your oven touch control panel	6
Cooking functions.....	8
Operating instructions for 3 key touch digital timer (E.G.O Basic Timer)	10
How to keep Your Oven in Shape	14
Practical Cooking Advice	18
Safety Is A Good Habit To Get Into	21
Installation	22
Technical Specifications	24

Congratulations on choosing our appliance, which you will find is dependable and easy to use.

We recommend that you read the instructions in this Manual carefully before use for the best performance and to extend the life of your appliance, as it will provide you with all the instructions you require to ensure its safe installation, use and maintenance. Always keep this Manual close to hand since you may need to refer to it in the future.

Thank you.

Conditions of use

This appliance is intended to be used for domestic use, not commercial use.

Safety precautions

- This appliance is not intended for use by persons (including children) with reduced physical, sensory or mental capabilities, or lack of experience and knowledge, unless they have been given supervision or instruction concerning use of the appliance by a person responsible for their safety.
- Warning – ensure that no downward pressure is applied to the oven door when open. In particular, DO NOT ALLOW a child to climb on to open oven door
- Warning - accessible parts can become hot during use, especially the oven door. To avoid burns, young children MUST BE KEPT AWAY.
- Young children should be supervised to ensure they do not play with this appliance.
- During use this appliance becomes hot. Care should be taken to avoid touching hot external and internal surfaces when in use. Use oven gloves.
- Install oven, shelving and fittings in accordance with this Manual.
- Ensure all specified vents, openings and air spaces are not blocked.
- To ensure your safety, all electric appliances should only be installed or serviced by qualified persons. If the supply cord is damaged, it must be replaced a service agent or similarly qualified person in order to avoid a hazard.
- Do not store flammable materials in the appliance or near this appliance.
- Do not modify this appliance.
- Appliance must be installed according to current laws and regulations by qualified tradesmen/Installers.

The Manufacturers and Importers / Distributors and Retailers shall not be liable to any legal liability, personal injury and property damage due to incorrect operation or incorrect Installation.

Other important safety information



This appliance must not be used as a space heater.



According to the electrical safety regulations the appliance equipment must be properly earthed.



Do not obstruct the ventilation slots on front.



Do not use corrosive cleaners e.g. oven cleaners that contain caustic soda.



Do not remove any labels or use abrasive/corrosive cleaners on.

Warnings for use of grill and oven

Grill warnings

- DO NOT cover the grill tray wire rack with foil.
- Trim excess fat from fatty meats, such as pork and lamb.
- Fat left on a grill tray is a fire hazard! Keep grill clean and turn off grill immediately.

Oven warnings

- DO NOT push down or apply any weight on open oven door.
- DO NOT place dishes on open door of oven
- DO NOT line oven with foil or place anything on the bottom of the oven while baking to avoid permanent damage, as trapped heat will crack or craze the enamel floor of the oven cavity liner.
- Use of olive oil and other poly-unsaturated oils (vegetable oils) when roasting uncovered food can leave deposits inside the oven which may be difficult to remove.

Disposal of packaging

Please recycle the cardboard, and also any polystyrene packaging where possible.

Close-up view

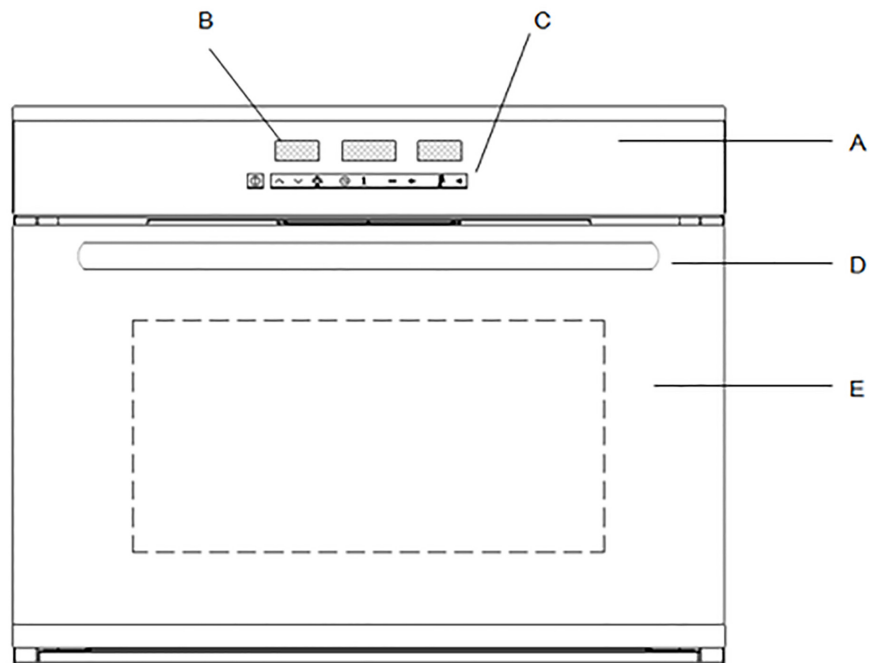

- A. Control Panel
- B. LED Display
- C. Touch Control Pad
- D. Handle
- E. Glass Oven Door

Using your oven touch control panel

Key operation:

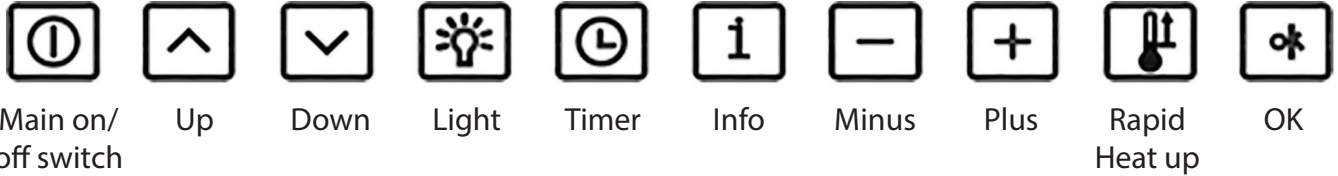

Time of Day / Minute Minder / Cooking time / End of time setting

- 1) When oven is connected to set Time of Day: press / to adjust the time before you switch the on/off key .
- 2) Minute Minder : press / to set the cooking time, press to start cooking. The Minute Minder count down starts to 0:00 (min:sec). The display shows the symbol and the remaining time is displayed continuously.
- 3) Cooking time : press / to set the cooking time 00:00 (hour: min), press to start cooking.
- 4) End of cooking time : after user sets the cooking time , press the key to set the end of cooking time. The oven starts as soon as the start time reaches.

For example: The time is 12:00 now, user sets the cooking time to 0:30(hour: min), then press to set the end of time to 12:40. The oven starts to cook at 12:10, and the display shows the remaining time of cooking.

Function setting



- 1) Press the key to switch on the oven. User can select the different cooking modes by pressing the key /.
- 2) Temperature can be set by the key / after the cooking mode is selected. Once the cooking mode and the temperature is fixed, press the key to start cooking.

Rapid heat-up

When the setting temperature exceeds 100 degrees and the pre-heat function hasn't been finished, user can press the key to start the rapid heat-up mode.

Using your oven touch control panel

Configuration setting

Press the "Info" key  for 5 seconds to set the mode. Then press the "Info" again to select Mode 1, Mode 2, Mode 3, Mode 4, Mode 5, Mode 6. Once selecting the mode, user can press / to select option 1, 2 or 3.

Mode	Description	Option 1	Option 2	Option 3
Mode 1	Time display	Display always	Display when oven is working	
Mode 2	"Beep" sound after the time count down	Short	Medium	Long
Mode 3	Duration of time setting	Short	Medium	Long
Mode 4	Cooling fan working time after oven finishes cooking	Short	Medium	Long
Mode 5	Display brightness	Dark	Medium	Bright
Mode 6	"Beep" sound when selecting the function mode	No	Yes	

After user finish the selection of "Info" mode, press the key  to confirm.

Cooking mode symbol

The sequence of cooking modes displayed in the screen as below:

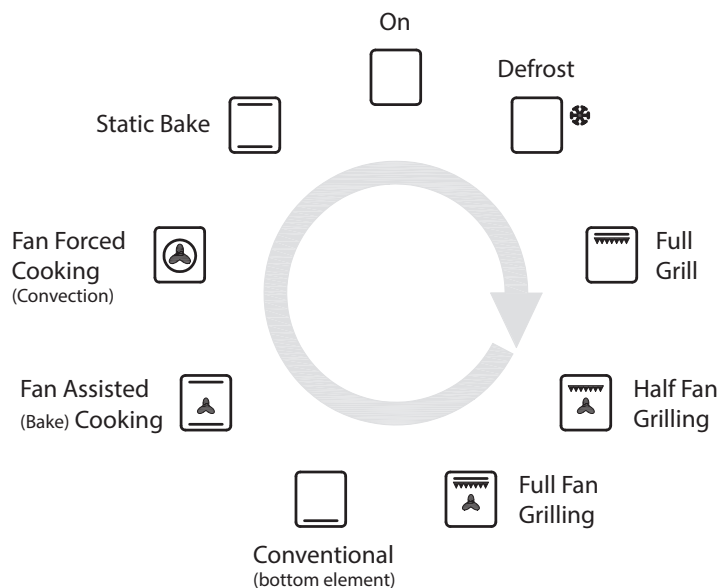

Child-safety lock

Press the  button for 5 sec after you switch off the oven

Cooking functions

Functions differ depending on the model of your oven.

Oven light

When the selector knob is in any position other than the "0" position, the oven light comes on.

Attention: The first time you use the oven we recommend that you set the thermostat on the highest setting and leave the oven on for about a half an hour with nothing in it. Then, open the oven door and let the room air. The odour that is often detected during this initial use is due to the evaporation of substances used to protect the oven during storage and until it is installed.

Defrost

Select this function to thaw more delicate foods. In this mode you use only the cold air circulation.

The thermostat light

This indicates that the oven is heating up. When the light goes out, the required temperature has been reached. When the light alternately comes on and goes out, it means that the thermostat is working properly to maintain the oven temperature.

Full grill

Important: do not the thermostat knob (C) to over 200°C. During grilling, keep the oven door closed. Both of the heating elements of the grill are activated. For more intensive grilling, select this function.

Fan forced (convection) Mode

Set the thermostat knob (C) between 50°C and 250°C. The circular heating element and the fan will come on. Since the heat remains constant and uniform throughout the oven, the air cooks and browns food uniformly over its entire surface. With this mode, you can also cook various dishes at the same time, as long as their respective cooking temperatures are the same. A maximum of 2 rack levels can be used at the same time. This cooking mode is ideal for au gratin dishes or those which require an extended cooking time.

Moreover, the excellent heat distribution makes it possible to use lower temperatures when cooking roasts. This results in less loss of juices, meat which is more tender and a decrease in the loss of weight for the roast. The ventilated mode is especially suited for cooking fish, which can be prepared with the addition of a limited amount of condiments, thus maintaining their flavour and appearance. The ventilated mode can also be used to thaw white or red meat, fish and bread by setting the temperature to 80°C-100°C.

Conventional (Bottom element)

Set the thermostat knob (C) between 50°C and 250°C. By turning the knob to this position. The oven light and lower heating element come on.

This position is recommended for finishing the cooking of food (in baking trays) which is already superficially well-cooked but still soft inside.

Cooking functions

Functions differ depending on the model of your oven.

Static Bake Mode

Set the thermostat knob (c) between 50°C and 250°C.

The outer heating elements at both the top and the bottom of the oven will come on. The heat is distributed uniformly from top to the bottom. The convection mode is recommended for preparing meat-based dishes featuring of liquids. It still remains the best cooking mode for dry pastries and fruit in general. When cooking in convection mode, only use one dripping-pan or cooking rack at a time, otherwise the heat distribution will be uneven. Select from among the various rack heights based on whether the dish needs more or less heat from the top or bottom.

Fan Assisted (Bake) Mode

Set the thermostat knob (c) between 50°C and 250°C.

The outer heating elements at both the top and the bottom of the oven are activated, as well as the fan. Based on the convection model, This combination of features increases the effectiveness of the thermal radiation of the heating elements through forced air circulation of the air throughout the oven. This helps prevent foods from burning on the surface, allowing the heat to penetrate into the food.

Half Fan Grill

Important: do not set thermostat knob (C) to over 200°C. During grilling, keep the oven door closed. All grill components and fan work. In this setting, the central heating elements of the top work. This combination of features compulsory in the air in the oven for the entire cycle of increased non-direct heating elements heat radiation effect. This will allow the heat to penetrate the internal food, and avoid food surface from being charred.

Full Fan Grill

Important: do not the thermostat knob (C) to over 200°C. During grilling, keep the oven door closed. Both of the heating elements of the grill are activated, as well as the fan and all grill components. This combination of features increases the effectiveness of the thermal radiation of the heating elements through forced air circulation of the air throughout the oven. This helps prevent foods from burning on the surface, allowing the heat to penetrate into the food.

Grill

Important: do not set thermostat knob (C) to over 200°C. During grilling, keep the oven door closed. Food is cooked in the grill by the downward thermal rays produced by an incandescent electric heating element. The high, direct grill temperature immediately browns meat, thus stopping juice dispersion and keeping meat more tender. The grill is particularly recommended for cooking dishes requiring a high superficial temperature.

Gentle pastry oven







Set the thermostat knob (C) between 50°C and 250°C. The lower heating element and the fan come on. This setting is ideal when cooking delicate foods, especially pastries that need to rise, because the heat rising from the bottom facilitates leavening. Please note that with this feature it takes a rather long time to reach higher temperatures in the oven. Therefore, if high temperatures are needed, we recommend that you use the "Conventional" setting.

Operating instructions for 3 key touch digital timer (E.G.O. Basic Timer)

1.0 Generally

The E.G.O Basic-Timer is specially designed for Built in Ovens and Free Standing Cookers. This Basic Timer is operated applying EGO Touch Control Technology.

2.0 Overview of functions and symbols:

	MINUTE MINDER
	COOKING TIME (PYROLYSIS DURATION)
	END of COOKING TIME (END of PYROLYSIS DURATION if applicable)
	TIME of DAY
	CHILD LOCK
	COOKING POT
Auto	AUTOMATIC Mode
Man	MANUAL Mode
P	PYROSYSIS Mode (Option)
L1,L2,L3	ACOUSTIC SIGNAL
23:59	7-Segment Display
99:00	Maximum adjustable MINUTE MINDER
23:59	Maximum adjustable COOKING TIME
h:min	Display hour : minutes
min:sec	Display minutes : seconds

2.1 MANUAL Mode

The EGO Timer remains in MANUAL Mode if no COOKING TIME or END of COOKING TIME is selected. The relay contact is closed and the symbol Man is displayed. The TIME of DAY is shown on the 7-segment display unless the MINDER is active.

2.2 AUTOMATIC Mode

If a COOKING TIME or a END of COOKING TIME is selected the switches to AUTOMATIC Mode. The relay contact is closed during the set COOKING TIME. The symbol Auto is displayed until the COOKING TIME or the END of COOKING TIME has expired.

3.0 Programmer Touch Control

3.1 Touchpad Display and Layout

The Programmer Touch Control has three Conductive Touch Keys

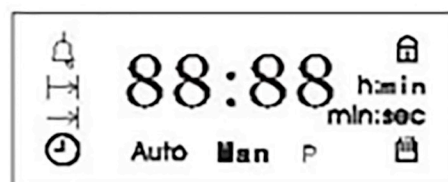

Touchpad SET (-):

Conductive key fitted into Touchpad position 1 or 2

Touchpad SELECT:

Conductive key fitted into Touchpad position 3

Touchpad SET (+):

Conductive key fitted into Touchpad position 4 or 5

3.2 Touchpad SET (+) and SET (-)

Touching SET (+) or SET (-) pad momentarily: touching pads momentarily increases res. Decreases time by one minute (or the volume of the ACOUSTIC SIGNAL by one step).

Touching SET (+) or SET (-) pad momentarily: permanent touching increases res. Decreases the speed of time setting automatically.

Operating instructions for 3 key touch digital timer (E.G.O. Basic Timer)

3.3 Touchpad SELECT

Using Touchpad SELECT allows to step through the sequences of function.

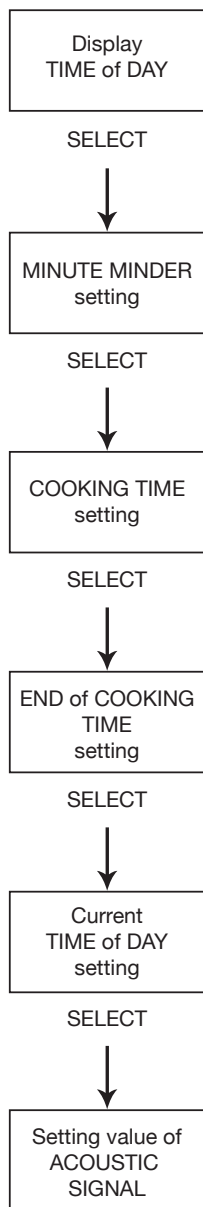

Touching Touchpad SELECT momentarily, the next following function is chosen.

Touching Touchpad SELECT permanently causes no automatic change. Touching Touchpad SELECT for more than 10 seconds an ACOUSTIC SIGNAL according chapter 5.2 occurs and the SELECT mode terminates automatically.

3.4 Touchpads SET(+) and SET(-)

Within 5 seconds after selection of a function, the time or the signal volume can be set with Touchpad SET (+) or SET (-).

4.0 Functions

4.1 Start of a function

5 seconds after setting, a set time or volume is accepted and the chosen function starts automatically. The display shows the current TIME of DAY, except the MINUTE MINDER is active. In this case the display shows the remaining time of the MINUTE MINDER.

4.2 Power ON / initial operation

Safety advice:

Line voltage 230V at the conductive keys! Do not touch without insulation.

Use correct insulation, that the user can not touch the conductive keys directly.

After connecting the unit to the mains, the display shows the default TIME of DAY 12:00 h:min flashing. In order to avoid the heaters to automatically switch on after a power failure, the relay contact opens as soon as power returns. Touching any pad the relay contact closes and the display shows the default time 12:00 h:min permanently.

The colon and the symbol ☺ continue to flash. It is possible now to set the current TIME of DAY as described in chapter 4.3.2

4.3 TIME of DAY

4.3.1 Select TIME of DAY mode

Step through the sequences of function with Touchpad SELECT as described in chapter 3.3 until the symbol flashes.

4.3.2 Set TIME of DAY

Set TIME of DAY by SET (+) or SET (-) as described in chapter 3.4

Display : 0.....24h

Format : h:min

4.4 Set ACOUSTIC SIGNAL volume

Step through the sequences of function until the display shows the chosen ACOUSTIC SIGNAL L1,L2 or L3. The signal volume can be increased resp. Decreased with Touchpad SET (+) or SET (-). The acoustical feedback sounds in the selected volume.

ACOUSTICAL SIGNAL volume

L1 = low

L2 = medium

L3 = loud

Operating instructions for 3 key touch digital timer (E.G.O. Basic Timer)

4.5 Minute Minder

4.5.1 Set MINUTE MINDER

Selection as described in chapter 3.3. until the symbol MINUTE MINDER  is flashing. The MINUTE MINDER can be set with Touchpad SET (+) or SET (-) acc. Chapter 3.4 up to a maximum of 99:00 min:sec

4.5.2 MINUTE MINDER runs down

5 seconds after setting the MINUTE MINDER count down starts in steps of seconds to 0:00 min:sec. The display shows the symbol MINUTE MINDER . The remaining time is displayed continuously. While setting other functions the MINUTE MINDER counts down covertly.

4.5.3 Modifying / Deleting MINUTE MINDER

The remaining time can be changed anytime by using Touchpad SET (+) or SET (-). The countdown is deleted by setting to 0:00 min:sec.

4.5.4 MINUTE MINDER has expired

The MINUTE MINDER time has expired once the MINUTE MINDER time has reached 0:00 min:sec. The symbol MINUTE MINDER  flashes. An ACOUSTIC SIGNAL according chapter 5.2 occurs.

After touching any Touchpad. The MINUTE MINDER mode terminates automatically. The display shows the current TIME of DAY. The ACOUSTIC SIGNAL and the MINUTE MINDER symbol  are switched off.

4.6 COOKING TIME

4.6.1 Set COOKING TIME

Selection as described in chapter 3.3. until the symbol COOKING TIME  is flashing. The COOKING TIME can be set with Touchpad SET (+) or SET (-) acc. Chapter 3.4. The maximum COOKING TIME is 23:59 h:min.

4.6.2 COOKING TIME runs down

5seconds after setting the MANUAL mode changes to the AUTOMATIC mode. The display shows the symbol COOKING POT  and the current TIME of DAY, except the MINUTE MINDER is active. The COOKING TIME counts down covertly in steps of minutes.

4.6.3 Modifying / Deleting COOKING TIME

Selection /Setting as described in chapter 3.3. until the symbol COOKING TIME  is flashing. The COOKING TIME can be changed with Touchpad SET(+) or SET (-) acc. Chapter 3.4. resp. can be deleted by setting it to 0:00 h:min.

4.6.4 COOKING TIME has expired

Once the COOKING TIME has expired, an ACOUSTIC SIGNAL acc. To chapter 5.2 occurs. The relay contact opens and the display shows 0:00 h:min. the symbol Man flashes.

After 7 min. at the latest or after touching any of the Touchpads the ACOUSTIC SIGNAL stops. The symbol Man flashes further on.

Touching SELECT again, causes a change to the MANUAL mode. The symbol Man is displayed continuously, the relay contact closes and the current TIME of DAY is displayed except the MINUTE MINDER is active.

4.7 END of COOKING TIME

4.7.1 Set END of COOKING TIME

Selection as described in chapter 3.3. until the symbol END of COOKING TIME  is flashing. The END of COOKING TIME can be set with Touchpad SET (+) or SET (-) acc. Chapter 3.4. The display shows the current TIME of DAY plus the set COOKING TIME. The END of COOKING TIME can be set with Touchpad SET(+) or SET(-) acc. Chapter 3.4. The COOKING TIME can be modified according chapter 4.7.3. The latest END of COOKING TIME is limited to the current TIME of DAY plus 23:59 h:min.

4.7.2 END of COOKING TIME runs down

5 seconds after setting, the MANUAL mode changes to the AUTOMATIC mode. The display shows the symbol COOKING POT  and the current TIME of DAY, except the MINUTE MINDER is active.

4.7.3 Modifying / Deleting END of COOKING TIME

Selection as described in chapter 3.3. until the symbol END of COOKING TIME  is flashing. The END of COOKING TIME can be modified with Touchpad SET (+) or SET (-) acc. Chapter 3.4

If END of COOKING TIME is set without setting a COOKING TIME first, the END of COOKING TIME can be deleted by counting back by SET (-) until it equals current TIME of DAY.

If both, an END of COOKING TIME plus a COOKING TIME have been set, the END of COOKING TIME can be deleted acc. Chapter 4.6.3 (deleting COOKING TIME).

END of COOKING TIME has expired

See chapter 4.6.4

Operating instructions for 3 key touch digital timer (E.G.O. Basic Timer)

4.8 Delayed COOKING

The relay contact automatically closes upon the calculated START TIME and opens after END of COOKING TIME is reached.

Calculation of START TIME as below:

Example 1:

Current TIME of DAY 10:00 h:min	Selected COOKING TIME 1:15 h:min	Selected END of COOKING TIME 12:15 h:min
---------------------------------------	---	--

Calculation of START TIME:
END of COOKING TIME minus COOKING TIME =
12:15 h:min – 1:15 h:min = 11:00 h:min

Example 2:

Current TIME of DAY 10:00 h:min	Selected COOKING TIME 1:15 h:min	Selected END of COOKING TIME 11:15 h:min
---------------------------------------	---	--

Calculation of START TIME:
END of COOKING TIME minus COOKING TIME =
11:15 h:min – 1:15 h:min = 10:00 h:min



Example 2 shows that the earliest END of COOKING TIME equals to current TIME of DAY (in this case 10:00 h:min) plus COOKING TIME (in the case 1:15 h:min). Therefore in this case the earliest End of COOKING TIME is 11:15 h:min.

COOKING TIME starts as soon as the START TIME is reached. The relay is closed and the symbol COOKING POT  is displayed.

4.8.1 Set DELAYED COOKING

1. Set desired COOKING TIME
acc. Chapter 4.6.1
2. Set desired END of COOKING TIME
acc. Chapter 4.7.1

4.8.2 DELAYED COOKING runs down

The relay contact is opened and the symbol COOKING POT  is off until START TIME is reached. COOKING TIME starts as soon as the START TIME is reached. The relay is closed and the symbol COOKING POT  is displayed.

4.8.3 Modifying / Deleting DELAYED COOKING

Modifying / Deleting of COOKING TIME
see chapter 4.6.3

Modifying / Deleting of END of COOKING TIME
see chapter 4.7.3.

4.8.4 DELAYED COOKING has expired

See chapter 4.6.4 (COOKING TIME has expired).

4.9 Child Lock

To avoid unwanted selection, setting resp. change of functions, the unit disposes a CHILD LOCK function.

4.9.1 Activation of CHILD LOCK

The CHILD LOCK function can be activated while TIME of DAY is displayed in MANUAL mode, regardless whether a COOKING TIME or an END of COOKING TIME runs down in AUTOMATIC mode.

CHILD LOCK function is activated by touching SET (+) for a minimum of 5 seconds until the CHILD LOCK symbol  is displayed. From this moment on all other functions are locked.

Exception: If a function, e.g. COOKING TIME has expired, the ACOUSTIC SIGNAL can be terminated by touching any Touchpad, although the CHILD LOCK is active.

Touching any of the Touchpads while CHILD LOCK is activated causes an ACOUSTIC SIGNAL acc. Chapter 5.2 and the CHILD LOCK symbol flashes for two seconds.

4.9.2 Deactivation of CHILD

CHILD LOCK function is deactivated by touching Touchpad SET (+) again for a minimum of 5 seconds until the CHILD LOCK symbol  switches off. From this moment on all functions are selectable again.

4.9.3 CHILD LOCK in MANUAL Mode

Activating the CHILD LOCK in MANUAL mode completely locks the appliance by switching off the relay contact. The symbol Man is switched off. After deactivation according chapter 4.9.2, the symbol Man is displayed again and the relay contact closes.

4.9.4 Power failure while CHILD LOCK is activated:

The child lock remains activated after a power failure. Before renewing the settings, the CHILD LOCK has to be deactivated. See 4.9.2.

How to keep Your Oven in Shape

This appliance is for household use only, don't use it outdoors!

Important: Before cleaning your oven, or performing maintenance, disconnect it from the power supply.

To extend the life of your oven, it must be cleaned frequently, keeping in mind that:

- Do not use steam equipment to clean the appliance.
- To protect against the risk of electrical shock, do not immerse the unit, cord or plug in water or other liquid or sprinkle water to clean the appliance!
- Don't clean the appliance when it still hot! The inside and external surface of the oven should preferably be cleaned by damp cloth when it is cooled down.
- Wash all accessories in hot sudsy water or in a dishwasher, wipe dry with a paper or cloth towel.
- If you use your oven for an extended period of time, condensation may form. Dry it using a soft cloth.
- There is a rubber seal surrounding the oven opening which guarantees its perfect functioning. Check the condition of this seal on a regular basis. If necessary, clean it and avoid using abrasive products or objects to do so. Should it become damaged, please contact your nearest After-sales Service Centre. We recommend you avoid using the oven until it has been repaired.
- Never line the oven bottom with aluminium foil, as the consequent accumulation of heat could compromise the cooking and even damage the enamel.
- Clear the glass door using damp cloth and dry it with a soft cloth. Do not use harsh abrasive cleaners or sharp metal scrapers to clean the oven door glass since they can scratch the surface, which may result in shattering of the glass.

Replacing the Lamp in the Oven

- Cut off the supply of power to the oven by turning off the omni-polar switch connecting it to the mains, or by removing the plug if it is accessible; Avoids appearing the electric shock;
- Unscrew the glass cover attached to the lamp holder;
- Unscrew the lamp and replace it with another high-temperature lamp (300) with the following characteristics:

- Voltage: AC220V-240V
- Wattage: 15W
- Socket: E 14

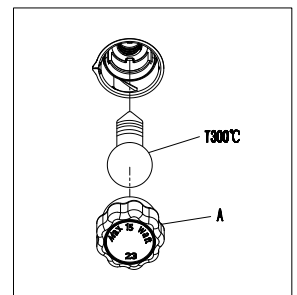

- Remount the glass cover and reconnect the appliance to the power supply.

WARNING: Ensure that the appliance is switched off before replacing the lamp to avoid the possibility of electric shock.

WARNING: Do not operate appliance with damaged cord or plug or after the appliance malfunctions, or has been damaged in any manner, return appliance to the nearest Authorized Service Center for examination. Repair, or adjustment!

How to keep Your Oven in Shape

Important: The following maintenance should be performed by Authorized Service Center or similarly qualified persons in order to avoid a hazard!

Fitting on a power supply cable

Opening the terminal board:

- Using a screwdriver, prise on the side tabs of the terminal board cover;
- Pull open the cover of the terminal board

To install the cable, proceed as follows:

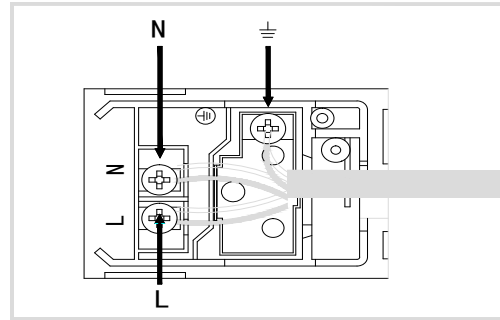
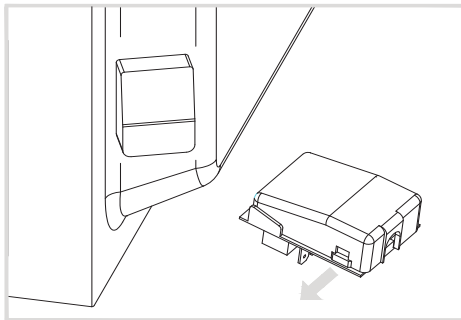

- Remove the wire clamp screw and the three contact screws L-N
- Fasten the wires beneath the screwheads using the following color scheme; Blue / Black (N) Brown / Red (L), Yellow-Green
- Fasten the supply cable in place with the clamp and close the cover of the terminal board.

Connecting the supply cable to the mains

Install a standardized plug corresponding to the load indicated on the data plate. When connecting the cable directly to the mains, install an omnipolar circuit-breaker with a minimum contact opening of 3 mm between the appliance and the mains. The omnipolar circuit breaker should be sized according to the load and should comply with current regulations (the earth wire should not be interrupted by circuit breaker).

The supply cable should be positioned so that it does not reach a temperature of more than 50 with respect to the room temperature, anywhere along its length.

Before making the connection, check that:

- the electrical safety of this appliance can only be guaranteed if the cooker is correctly and efficiently earthed, ways ensure that the earthing is efficient; if you have any doubts call in a qualified technician to check the system. The manufacturer declines all responsibility for damage resulting from a system which has not been earthed.
- Before plugging the appliance into the mains, check that the specifications indicated on the data plate (on the appliance and/or packaging) correspond to those of the electrical mains system of your home.
- Check that the electrical capacity of the system and sockets will support the maximum power of the appliance, as indicated on the data plate. If you have any doubts, call in a qualified technician.
- If the socket and appliance plug are not compatible, have the socket replaced with a suitable model by a qualified technician. The latter, in particular, will also have to ensure that the cross section of the socket cables are suitable for the power absorbed by the appliance. The use of adapters, multiple sockets and/or extensions, is not recommended. If their use cannot be avoided, remember to use only single or multiple adapters and extensions which comply with current safety regulations. In these cases, never exceed the maximum current capacity indicated on the single adapter or extension and the maximum power indicated on the multiple adapter. The plug and socket must be easily accessible.

WARNING: It is essential to use specific soft wire or specific groupware bought from the manufacturer or maintenance department to replace if the electrical soft wire has been broken.

How to keep Your Oven in Shape

Useful Notes For Cooking

In the following table, some indicative hints for cooking:

Faults	Causes	Remedies
The upper crust is dark and the lower part too pale	Not enough heat from the bottom	Use the natural convection position Use deeper cake tins Lower the temperature Put the cake on a lower shelf
The lower part is dark and the upper crust too pale	Excessive heat from the bottom	Use the natural convection position Use lower side tins Lower the temperature
The outside is too cooked and the inside not cooked enough	Too high temperature	Lower the temperature and increase the cooking time
The outside is too dry even though of the right color	Too low temperature	Increase the temperature and reduce the cooking time.



This product must not be disposed together with the domestic waste. This product has to be disposed at an authorized place for recycling of electrical and electronic appliances.

By collecting and recycling waste, you help save natural resources, and make sure the product is disposed in an environmental friendly and healthy way.

Warnings

During operation, the oven glass door and adjacent parts of the appliance become hot. Make sure, therefore, that children do not touch the appliance.

This appliance is not intended for use by persons (including children) with reduced physical, sensory or mental capabilities or lack of experience and knowledge, unless they have been given supervision or instruction concerning use of the appliance by a person responsible for their safety.

Children should be supervised to ensure that they do not play with the appliance.

How to keep Your Oven in Shape

Disassembling/assembling the oven door

To make it easier to clean the inside of your oven, the oven door can be removed, by proceeding as follows (fig. 1-2):

- Open the door completely and lift the 2 levers "B" (fig.1);
- Now, shutting the door slightly, you can lift it out by pulling out the hooks "A" as shown in figure 2.

To reassemble the door:

- With the door in a vertical position, insert the two hooks "A" into the slots;
- Ensure that seat "D" is hooked perfectly onto the edge of the slot (move the oven door backwards and forward slightly);
- Keep the oven door open fully, unhook the 2 levers "B" downwards and then shut the door again.

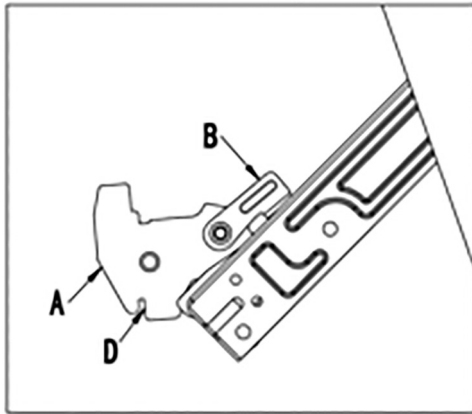

Fig. 1

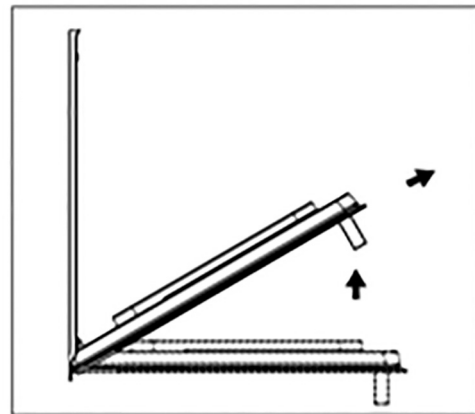

Fig. 2

Practical Cooking Advice

Preheating

If the oven must be preheated (generally this is the case when cooking leavened foods) use the “Fan forced mode” in order to save on energy.

Once the food has been placed in the oven. The most appropriate cooking mode can then be selected.

Using the grill

The Multifunction oven offers you three different grilling modes.

Use the “Half or Half fan grill” setting for grilling in perfect mode small portions like toasted sandwiches, hotdogs, etc., to perfection.

The “ Full grill” position is the best for grilling foods rapidly. For a better distribution of heat, not only to brown the surface but also to cook the bottom part, select “Full Fan Grill” function.

This mode can also be used for browning foods at the end of the cooking process.

Important: always use the grill with the oven door closed. This will allow you both to attain excellent results and to save energy

When using any of the three grilling modes , it is recommended that the thermostat knob be turned to the 175°C, as it is the most efficient way to use the grill (which utilizes infrared rays).

If necessary, however, the thermostat can be set to lower temperatures by simply turning the knob to the desired setting.

When utilizing the grill, place the rack at the lower levels (see cooking table). To catch grease or fat and prevent smoke, place a dripping-pan at the bottom rack level.

Baking pastries

When baking pastries, always place them in the oven after it has been preheated. Make sure you wait until the oven has been preheated thoroughly (the red thermostat indicator light will turn off). Do not open the door while the pastry is cooking in order to prevent it from dropping.

Batters must not be too runny, as this will result in prolonged cooking times.

In general

Problem	Remedy
Pastry is too dry	Increase the temperature by 10°C and reduce the cooking time.
Pastry dropped	Use less liquid or lower the temperature by 10°C
Pastry is too dark on top	Place it on a lower rack, lower the temperature, and increase the cooking time.
Cooked well on the inside but sticky on the outside	Use less liquid, lower the temperature, and increase the cooking time.
The pastry sticks to the pan	Grease the pan well and sprinkle it with a dusting of flour.
I used more than one level and they are not all at the same cooking point	Use a lower temperature setting. It is not necessary to remove the food from all the racks at the same time.

Practical Cooking Advice

Cooking Pizza

For best results when cooking pizza use the “Ventilation mode”:

- Preheat the oven for at least 10 minutes;
- Use a light aluminium pizza pan, placing it on the broiler supplied with the oven. If the dripping-pan is used, this will extend the cooking time, making it difficult to get a crispy crust;
- Do not open the oven door frequently while the pizza is cooking;
- If the pizza has a lot of toppings (three or four), it is recommended that the mozzarella cheese be placed on top halfway through the cooking process;

Cooking Fish and Meat

Meat must weigh at least 1 Kg in order to prevent it from drying out. When cooking white meat, fowl and fish, use low temperature settings (150°C-220°C). For red meat that should be well done on the outside while tender and juicy in the inside, it is a good idea to start with a high temperature setting (200°C-220°C) for a short time, then turn the oven down afterwards. In general, the larger the roast, the lower the temperature setting. Place the meat on the centre of the rack and place the dripping pan beneath it to catch the fat.

Make sure that the rack is inserted so that it is in the centre of the oven. If you would like to increase the amount of heat from below, use the low rack heights. For savory roasts (especially duck and wild game), dress the meat with lard or bacon on the top.

Grilling

Type of dish	Cooking time (minutes)	Position of shell
Chops (0.5 kg)	25	3rd guide rail
Sausages	15	2nd guide rail
Grilled chicken (1 kg)	60	1st guide rail
Veal on the spit (0.6 kg)	60	-
Chicken on the spit (1 kg)	60	-

Cooking times may vary according to the nature of the foods, their homogeneity and their volume. When cooking a certain food for the first time, it is advisable to choose the lowest values in the cooking time range given in the table and then increase them if necessary.

The 1st guide rail is understood as being the lowest position.

Practical Cooking Advice

NOTE: The table below, temperatures and cooking times, should be referred to purely as GUIDES only. Cook Books and their Recipes should be referred to for detailed requirements of temperature settings and cooking times.

TIP: As all ovens are manufactured and perform differently we recommend when using your new oven or trying new recipes to reduce both the recommended temperature and cooking time by at least 10 percent to get use to your oven and make necessary modifications to get the best results from your new oven.

Static Oven Cooking

Pastries and cakes	Temperature (°C)	Cooking time (Minutes)
Fruit pie	130	60-70
Meringues	130	30-40
Sponge cake	150	20-30
Angel cake	160	40-50
Madeira cake	160	40-50
Chocolate cake	170	30-40
Flat sweet loaf	170	40-50
Puffs	200	15-20
Flaky pastry biscuits	200	15-20
Mille feuilles	200	15-20
Short pastry	200	15-20

Meat	Temperature (°C)	Cooking time (minutes)
Braised beef (1-1.5 kg)	160	60-75
Leg of lamb (1.5kg)	160	75
Chicken(1-1.5 kg)	180	60-75

Fish	Temperature (°C)	Cooking time (Minutes)
Fish	200	15-25

Safety Is A Good Habit To Get Into

- This appliance is designed for non-professional, household use and its functions must not be changed.
- The electrical system of this appliance may be used safely only when it is correctly connected to an efficient earthing system in compliance with the safety standards currently in effect.
- The manufacturer will not be held liable for any damages that might arise out of incorrect installation or improper, incorrect or unreasonable use of the appliance.

The following items are potentially dangerous, and, therefore, appropriate measures must be taken to prevent children and the disabled from coming into contact with them:

- Controls and the appliance in general;
- Packaging (bags, polystyrene, nails, etc.);
- The appliance immediately after use of the oven or grill due to the heat generated;
- The appliance when no longer in use (potentially dangerous parts must be made safe).

Avoid the following:

- Touching the appliance with wet parts of the body;
- Using the appliance when barefoot;
- Pulling on the appliance or the supply cord to unplug it from the electrical outlet;
- Obstructing the ventilation or heat dissipation slots;
- Allowing power supply cords for small appliances to come into contact with the hot parts of the appliance;
- Exposing the appliance to atmospheric agents (rain, sun);
- Using the oven for storage purposes;
- Using flammable liquids near the appliance;
- Using adaptors, multiple sockets and/or extension cords;
- Attempting to install or repair the appliance without the assistance of qualified personnel.

WARNING: Accessible parts will become hot when in use. To avoid burns and scalds children should be kept away

During use the appliance becomes hot, Care should be taken to avoid touching heating elements inside the oven.

Qualified personnel must be contacted in the following cases:

- Installation (following the manufacture's instructions);
- When in doubt about operating the appliance;
- Replacing the electrical outlet when it is not compatible with the plug for the appliance.

Service Centres authorized by the manufacturer must be contacted in the following cases:

- If in doubt about the soundness of the appliance after removing it from the packaging;
- If the power supply cord has been damaged or needs to be replaced;
- If the appliance breaks down or functions poorly; ask for original spare parts.

It is a good idea to do the following:

- Only use the appliance to cook food, nothing else;
 - Check the soundness of the appliance after it has been unpacked;
 - Disconnect the appliance from the electrical mains if it is not functioning properly and before cleaning or performing maintenance;
 - When the appliance is not used for an extended period of time, cut off the supply of power and close the gas cock (if present);
 - Use cooking gloves to place cookware in the oven or when removing it;
 - Always grasp the oven door in the centre because the ends may be hot due to the escape of hot air;
 - Make sure that the control knobs are on the "o" setting when the appliance is not in use;
 - Cut the power supply chord after disconnecting it from the mains when you decide not to use the appliance any longer.
- The manufacturer may not be held responsible for any damage due to: incorrect installation, improper, incorrect and irrational use.

Installation

Important: the power supply to the appliance must be cut off before any adjustments or maintenance work is done on it.

Installation of Built-in Ovens

To ensure the proper working order of the built-in appliance, the kitchen unit must be of a suitable size.

The sizes of the unit for installing the cooker under a worktop or in a column unit are shown in figure.

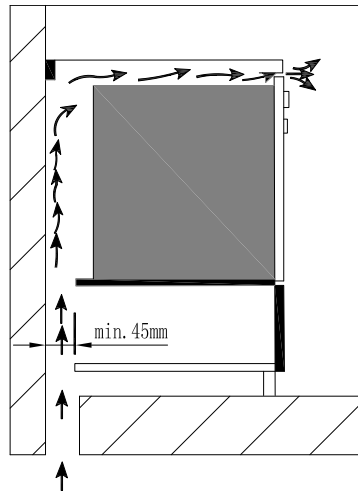

o provide adequate ventilation, there must be appropriate ventilation openings in the front bottom and the top part of 200 cm² , and an exhaust opening on the bottom of an least 200 cm² , and an exhaust opening of at least 60 cm² .

The unit panels next to the cooker must be heat resistant. In the case of veneered wood units, glues must be resistant to a temperature of 120°C.

In accordance with safety standards, once the appliance has been mounted, there must be no possible contact with electrical parts. Any protective parts must be secured so that they can only be removed with the use of tools.

o

Installation

Fastening the oven

Insert the appliance into the compartment; open the oven door and fasten the oven to the cabinet using the four screws "A", remembering to place the special spacers provided between the hole and the screw itself.

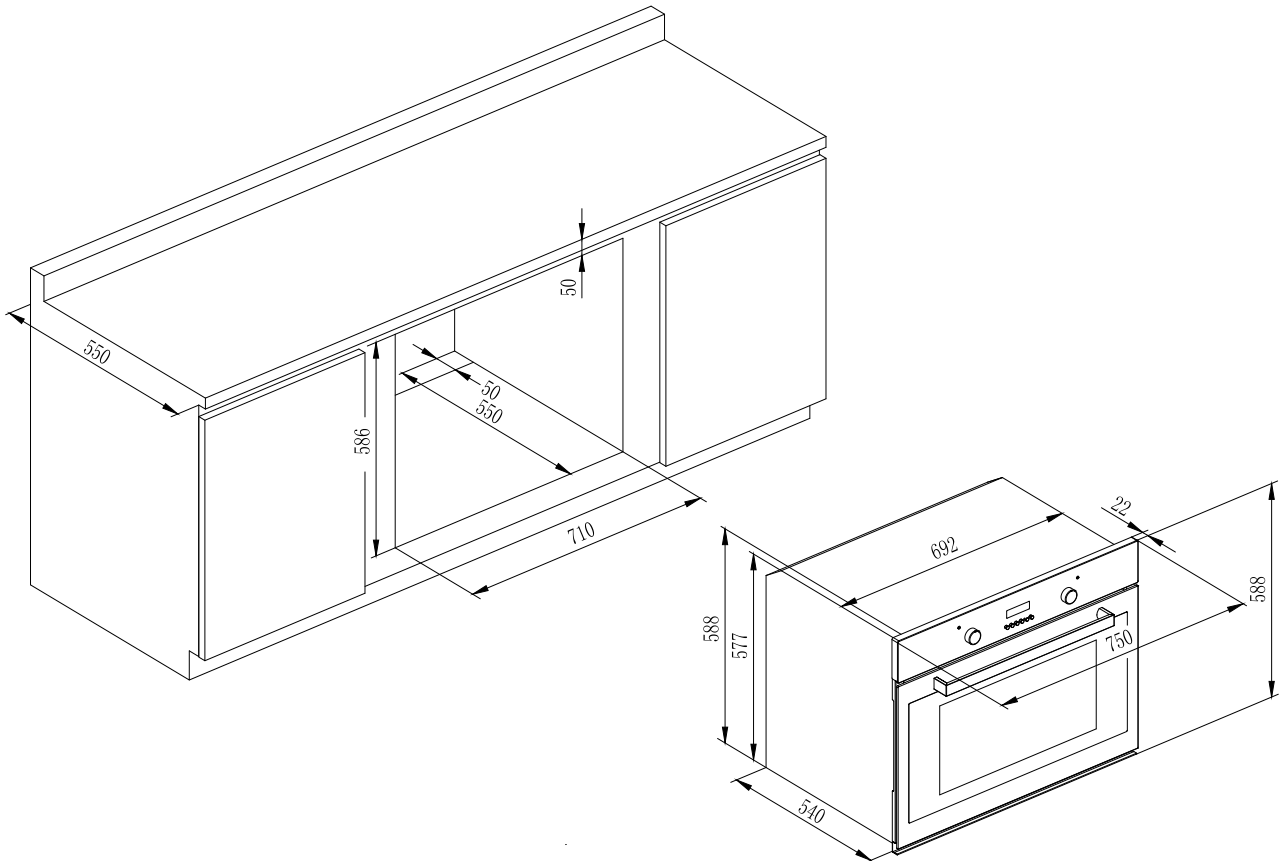

Electric connection

Cookers with a three-pole power supply cable are designed to operate with alternated current at the supply frequency and voltage indicated on the data plate (at the bottom of the oven dashboard). The earthing conductor of the cable is the yellow-green conductor.

Connecting the power supply cable to the mains

The appliance must be directly connected to the mains using an omnipolar circuit-breaker with a minimum contact opening of 3 mm installed between the appliance and the mains, suitable for the load indicated and complying with current directives (the earthing wire must not be interrupted by the circuit-breaker).

The power supply cable must be positioned so that it does not exceed 50°C more than room temperature at any point of its length.

Before making the connection check that:

- the limiter valve and the home system can support the appliance load (see data plate);
- the power supply system has an efficient earthing connection which complies with the provisions of current regulations;
- the socket or omnipolar circuit-breaker is easily accessible once the cooker has been installed.

NOTE: do not use reducers, adaptors or shunts as they could cause overheating and burns.

Technical Specifications

Oven (Net) Capacity

Electric oven	68 litres
---------------	-----------

Internal Oven Dimensions

Width	54 cm
Depth	38 cm
Height	33 cm

Powers absorbed in accordance with models

Oven lower heating el. 1300 Watt	Half grill heating el. 2000 Watt	Syncromotor 4 Watt
Oven upper heating el. 1050 Watt	Full grill heating el. 1050 +2000 Watt	Shaded motor (back) 25 Watt
Oven light 15 Watt	Rear Circular heating el. 2800 Watt	Shaded motor (top) 15 Watt

Power Requirements

Voltage end frequency	220-240V/50Hz
Power supply Max	3400W (240V) - 2800W (220V)