

Register your product and get support at
www.philips.com/welcome

MCM2050



EN User manual

PHILIPS

Contents

1 Important	4	7 Product information	17
Know these safety symbols	4	Specifications	17
Hearing Safety	5	USB playability information	18
		RDS program types	18
		Supported MP3 disc formats	19
2 Your micro system	6	8 Troubleshooting	20
Introduction	6		
What's in the box	6	9 Notice	21
Overview of the main unit	7		
Overview of the remote control	8		
3 Get started	9		
Placement	9		
Connect FM antenna	9		
Prepare the remote control	9		
Connect power	10		
Set clock	10		
Turn on	10		
Store FM radio stations automatically	11		
4 Play	12		
Play disc	12		
Play from USB	12		
Play options	12		
Adjust sound	13		
Display different information	13		
5 Listen to FM radio	14		
Tune to FM radio stations	14		
Program FM radio stations automatically	14		
Program FM radio stations manually	14		
Select a preset radio station	14		
Show RDS information	14		
Select stereo/mono broadcast	15		
6 Other features	16		
Set the alarm timer	16		
Set the sleep timer	16		
Play from external audio device	16		
Listen through the headphone	16		

1 Important

- Read these instructions.
- Follow all instructions.
- Do not block any ventilation openings. Install in accordance with the manufacturer's instructions.
- Do not install near any heat sources such as radiators, heat registers, stoves, or other apparatus (including amplifiers) that produce heat.
- Protect the power cord from being walked on or pinched, particularly at plugs, convenience receptacles, and the point where they exit from the unit.
- Only use attachments/accessories specified by the manufacturer.
- Unplug this unit during lightning storms or when unused for long periods of time.
- Refer all servicing to qualified service personnel. Servicing is required when the unit has been damaged in any way, such as power-supply cord or plug is damaged, liquid has been spilled or objects have fallen into the apparatus, the unit has been exposed to rain or moisture, does not operate normally, or has been dropped.
- The unit shall not be exposed to dripping or splashing.
- Do not place any sources of danger on the unit (e.g. liquid filled objects, lighted candles).
- Battery usage CAUTION – To prevent battery leakage which may result in bodily injury, property damage, or damage to the remote control:
 - Install all batteries correctly, + and - as marked on the remote control.
 - Do not mix batteries (old and new or carbon and alkaline, etc.).
 - Remove batteries when the remote control is not used for a long time.
- Where the plug of the Direct Plug-in Adapter is used as the disconnect device, the disconnect device shall remain readily operable.

Know these safety symbols



This 'bolt of lightning' indicates uninsulated material within your unit may cause an electrical shock. For the safety of everyone in your household, please do not remove product covering.

The 'exclamation point' calls attention to features for which you should read the enclosed literature closely to prevent operating and maintenance problems.

WARNING: To reduce the risk of fire or electric shock, this apparatus should not be exposed to rain or moisture and objects filled with liquids, such as vases, should not be placed on this apparatus.

CAUTION: To prevent electric shock, match wide blade of plug to wide slot, fully insert.

Warning

- Never remove the casing of this apparatus.
- Never lubricate any part of this apparatus.
- Never place this apparatus on other electrical equipment.
- Keep this apparatus away from direct sunlight, naked flames or heat.
- Never look into the laser beam inside this apparatus.
- Ensure that you always have easy access to the power cord, plug or adaptor to disconnect this apparatus from the power.

Hearing Safety

Danger

- To avoid hearing damage, limit the time you use the headphones at high volume and set the volume to a safe level. The louder the volume, the shorter is the safe listening time.

Be sure to observe the following guidelines when using your headphones.

- Listen at reasonable volumes for reasonable periods of time.
- Be careful not to adjust the volume continuously upwards as your hearing adapts.
- Do not turn up the volume so high that you can't hear what's around you.
- You should use caution or temporarily discontinue use in potentially hazardous situations.
- Excessive sound pressure from earphones and headphones can cause hearing loss.

Caution

- Use of controls or adjustments or performance of procedures other than herein may result in hazardous radiation exposure or other unsafe operation.

2 Your micro system

Congratulations on your purchase, and welcome to Philips! To fully benefit from the support that Philips offers, register your product at www.philips.com/welcome.

Introduction

With this unit, you can:

- enjoy audio from discs, USB devices, and other external devices
- listen to FM radio stations

You can enrich sound output with these sound effects:

- Digital Sound Control (DSC)
- Dynamic Bass Boost (DBB)

The unit supports these media formats:



What's in the box

Check and identify the contents of your package:

- Main unit
- Remote control
- Power adapter
- 1 x MP3 link cable
- Mounting kit (2 dowels and 2 screws)
- FM antenna
- User manual
- Quick start guide
- Wall mounting instructions





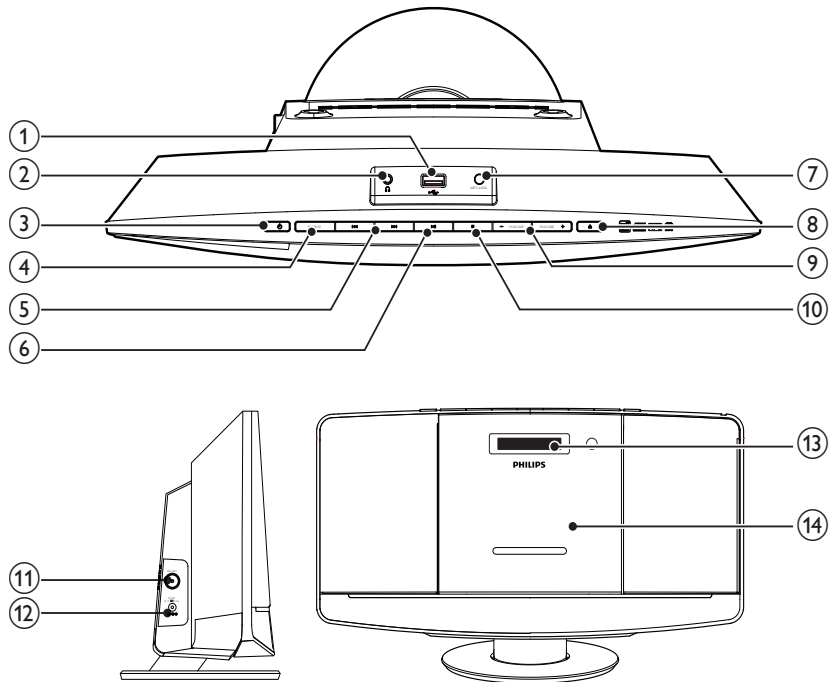

If you contact Philips, you will be asked for the model and serial number of this apparatus. The model number and serial number are on the bottom of the apparatus. Write the numbers here:

Model No. _____

Serial No. _____

Overview of the main unit



- | | |
|--|---|
| <p>① </p> <ul style="list-style-type: none"> • Connect USB device. <p>② </p> <ul style="list-style-type: none"> • Headphone socket. <p>③ </p> <ul style="list-style-type: none"> • Turn the unit on/off. • Switch to standby mode. <p>④ SOURCE</p> <ul style="list-style-type: none"> • Select a source: CD, FM, USB, or MP3 LINK. <p>⑤ </p> <ul style="list-style-type: none"> • Skip to the previous/next track. • Search within a track/disc. • Tune to radio stations. • Adjust time. <p>⑥ </p> <ul style="list-style-type: none"> • Start/pause play. | <p>⑦ MP3-LINK</p> <ul style="list-style-type: none"> • Connect an external audio device. <p>⑧ </p> <ul style="list-style-type: none"> • Open/close the disc tray. <p>⑨ VOLUME + / -</p> <ul style="list-style-type: none"> • Adjust volume. <p>⑩ </p> <ul style="list-style-type: none"> • Stop play or erase a program. <p>⑪ FM ANT</p> <ul style="list-style-type: none"> • Improve FM reception. <p>⑫ DC IN</p> <ul style="list-style-type: none"> • Connect power. <p>⑬ Display panel</p> <ul style="list-style-type: none"> • Show play information. <p>⑭ Disc tray</p> |
|--|---|

Overview of the remote control

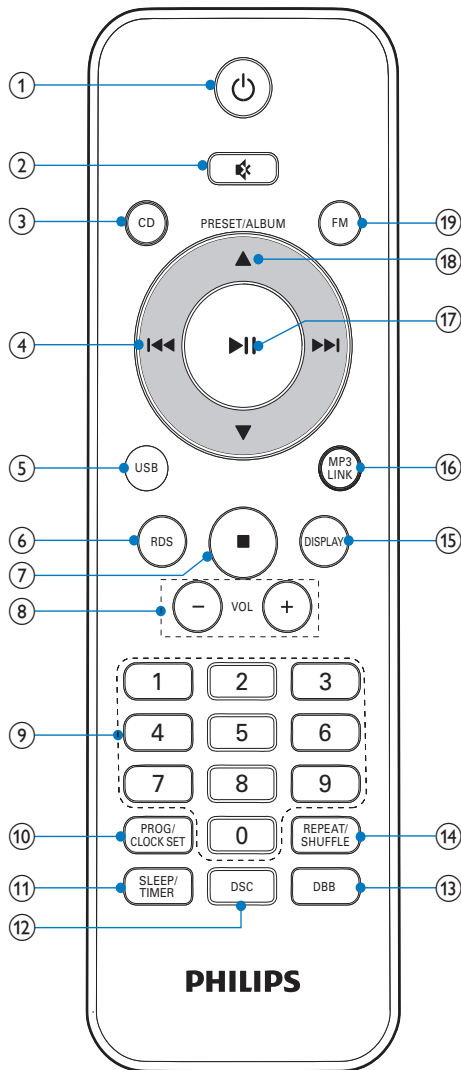

- ① Turn the unit on/off.
 • Switch to standby mode.
- ② Mute/restore sound.

- ③ **CD**
 • Select CD source.
- ④ Skip to the previous/next track.
 • Search within a track/disc.
 • Tune to radio stations.
 • Adjust time.
- ⑤ **USB**
 • Select USB source.
- ⑥ **RDS**
 • For selected FM radio stations: display RDS information.
- ⑦ Stop play or erase a program.
- ⑧ **VOL +/-**
 • Adjust volume.
- ⑨ **Numeric Keypad 0 - 9**
 • Select a track from a disc directly.
 • Select a preset radio station.
- ⑩ **PROG/CLOCK SET**
 • Program tracks.
 • Program radio stations.
 • Set time.
- ⑪ **SLEEP/TIMER**
 • Set sleep/alarm timer.
- ⑫ **DSC**
 • Select a preset sound setting.
- ⑬ **DBB**
 • Turn dynamic bass enhancement on or off.
- ⑭ **REPEAT/SHUFFLE**
 • Play a track or all tracks repeatedly.
 • Play tracks randomly.
- ⑮ **DISPLAY**
 • Show current information.
- ⑯ **MP3 LINK**
 • Select MP3 link source.
- ⑰ Start/pause play.
- ⑱ Select a preset radio station.
 • Skip to previous/next album.
- ⑲ **FM**
 • Select FM tuner source.

3 Get started

! Caution

- Use of controls or adjustments or performance of procedures other than herein may result in hazardous radiation exposure or other unsafe operation.

Always follow the instructions in this chapter in sequence.

Placement

You can place the unit on a flat surface or mount the unit on a wall.

Mount on a wall

See the wall mounting instructions included in the package.

Connect FM antenna

* Tip

- For optimal reception, fully extend and adjust the position of the antenna.

Connect the supplied FM antenna to the **FM ANT** socket on the main unit.

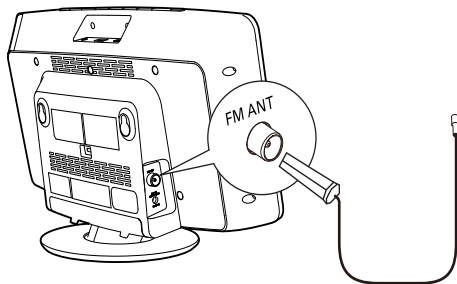

Prepare the remote control

! Caution

- Risk of explosion! Keep batteries away from heat, sunshine or fire. Never discard batteries in fire.
- Risk of decreased battery life! Never mix different brands or types of batteries.
- Risk of product damage! When the remote control is not used for long periods, remove the batteries.

To install the remote control battery:

- 1 Open the battery compartment.
- 2 Insert 2 AAA batteries with correct polarity (+/-) as indicated.
- 3 Close the battery compartment.

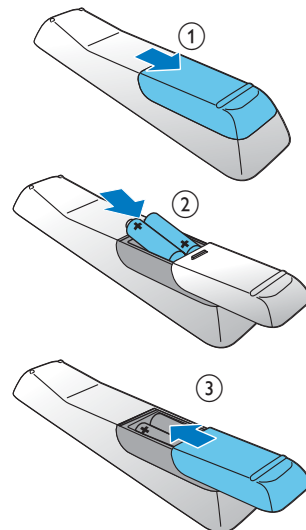

Connect power

! Caution

- Risk of product damage! Ensure that the power supply voltage corresponds to the voltage printed on the back or the underside of the unit.
- Risk of electric shock! When you unplug the AC power cord, always pull the plug from the socket. Never pull the cord.
- Before connecting the AC adapter, ensure that you have completed all other connections.

≡ Note

- The type plate is located at the back of the main unit.

Connect the power adapter to:

- the **DC IN** socket on the main unit.
- the wall socket.

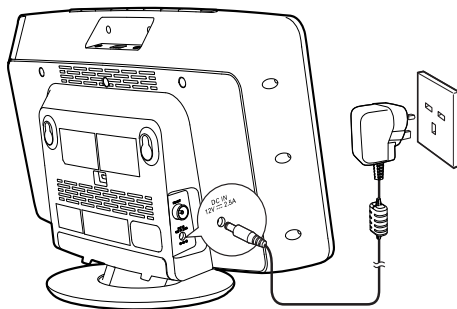

Set clock

- 1** In standby mode, press and hold **CLOCK SET** on the remote control for two seconds.
↳ **[SET CLOCK]** (set clock) scrolls on the display.
- 2** Press **CLOCK SET** again.
↳ The 12/24 hour format blinks.

- 3** Press **◀▶** repeatedly to select hour format.
- 4** Press **CLOCK SET** to confirm.
↳ The hour digits blink.
- 5** Repeat steps 3-4 to set the hour.
- 6** Repeat steps 3-4 to set the minute.
- 7** Repeat steps 3-4 to select whether to synchronize time of this unit with RDS stations.
 - **[NO SYNC CLOCK]**: time synchronization is deactivated.
 - **[SYNC RDS CLOCK]**: the unit synchronizes time from the RDS stations automatically.

≡ Note

- The accuracy of the transmitted time depends on the RDS station that transmits the time signal.
- If no button is pressed in 90 seconds, the unit exits clock setting mode automatically.

Turn on

Press **⏻**.

- ↳ The unit switches to the last selected source.

≡ Note

- To select a source, press **SOURCE** repeatedly or the source selection buttons on the remote control.

Switch to standby mode

Press **⏻** again to switch the unit to standby mode.

- ↳ The clock (if set) appears on the display panel.

Store FM radio stations automatically

When the unit turns to FM tuner mode, and no radio stations are stored, [AUTO INSTALL - PRESS PLAY, STOP CANCEL] (to auto install, press ►||; to cancel, press ■) is displayed.

Press and hold ►|| for 3 seconds to start full scan.

- ↳ The unit automatically stores FM radio stations with sufficient signal strength and then broadcasts the first preset station.



Tip

- To exit storing mode, press ◊ or ■.

4 Play

Play disc

- 1 Press **▲** to open the disc compartment.
- 2 Insert a disc with the printed side facing up.
- 3 Press **▲** to close the disc compartment.
- 4 Press **CD** on the remote control to select the disc source.
 - ↳ **[Reading]** (reading) blinks for a moment, then CD starts playing automatically. If not, press **▶||**.

Play from USB

Note

- Make sure that the USB device contains playable audio content.

- 1 Insert the USB device into the  socket.

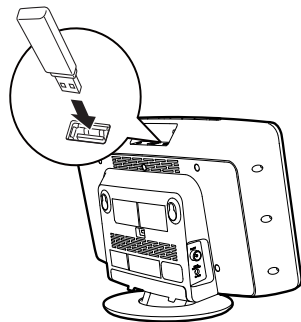





- 2 Press **USB** on the remote control to select the USB source.
 - ↳ The files play automatically. If not, press **▶||**.

Play options

Pause/resume play

During play, press **▶||** to pause/resume play.

Repeat/shuffle play

- 1 During play, press **REPEAT/SHUFFLE** repeatedly to select:
 -  : play the current track repeatedly.
 -  (for MP3/WMA only): play all tracks in this album repeatedly.
 -  : play all tracks repeatedly.
 -  : play all tracks randomly.
- 2 To resume normal play, press **REPEAT/SHUFFLE** repeatedly until the above icon disappears.

Skip to a track

For CD:

Press **◀◀ / ▶▶** to select another track.

For MP3 disc and USB:

- 1 Press **▲ / ▼** to select an album or a folder.
- 2 Press **◀◀ / ▶▶** to select a track/file.

Tip

- To select a track directly, you can also press a key on the numerical keypad.

Search within a track

- 1 During play, press and hold **◀◀ / ▶▶**.
- 2 Release to resume normal play.

Program tracks

You can program a maximum of 20 tracks.

- 1** In CD/USB mode, press **■** to stop playback, then press **PROG** to activate the programming mode.
↳ **[PROG]** (program) is displayed.
- 2** For MP3/WMA tracks, press **▲ / ▼** to select an album.
- 3** Press **◀◀ / ▶▶** to select a track, then press **PROG** to confirm.
- 4** Repeat steps 2 to 3 to program more tracks.
- 5** Press **▶▶** to play the programmed tracks.
↳ During play, **[PROG]** (program) is displayed.
 - To erase the program, when playback is stopped, press **■**.

Adjust sound

During play, you can adjust volume and select sound effects.

Function	Action
To increase/decrease volume	Press VOL +/- .
To mute/restore sound	Press ⏏ .
To turn dynamic bass enhancement on/off	Press DBB .
To select a sound effect: [POP] (pop) [JAZZ] (jazz) [CLASSIC] (classic) [ROCK] (rock) [FLAT] (flat)	Press DSC repeatedly.

Display different information

During play, press **DISPLAY** repeatedly to view time and different play information.

5 Listen to FM radio

Tune to FM radio stations

Note

- Position the antenna as far as possible from TV, VCR, or other radiation source.
- Ensure that you have connected and fully extended the supplied FM antenna.

- 1 Press **FM** to select FM tuner mode.
 - 2 Press and hold **◀▶** for 3 seconds.
 - ↳ **[SEARCH]** (search) is displayed.
 - ↳ The unit tunes to an FM station with strong reception automatically.
 - 3 Repeat step 2 to tune to more stations.
- To tune to a weak station:**
Press **◀▶** repeatedly until you find optimal reception.

Program FM radio stations automatically

Note

- You can program a maximum of 20 preset FM radio stations.

- In FM tuner mode, press and hold **PROG** for 3 seconds.
- ↳ **[AUTO]** (auto) is displayed.
 - ↳ The unit stores all the FM radio stations automatically and then broadcasts the first preset radio station.

Program FM radio stations manually

- 1 In tuner mode, tune to an FM radio station.
- 2 Press **PROG** to activate programming mode.
 - ↳ **[PROG]** (program) blinks.
- 3 Press **▲ / ▼** repeatedly to select a channel number.
- 4 Press **PROG** again to confirm.
- 5 Repeat steps 1-4 to store other FM stations.

Note

- To remove a pre-stored station, store another station in its place.

Select a preset radio station

In tuner mode, press **▲ / ▼** or the numeric buttons to select a preset number.

Show RDS information

RDS (Radio Data System) is a service that allows FM stations to show additional information. If you tune to an RDS station, an RDS icon is displayed.

- 1 Tune to an RDS station.
- 2 Press **RDS** repeatedly to scroll through the following information (if available):
 - ↳ Program service
 - ↳ Program type such as **[NEWS]** (news), **[SPORT]** (sport), **[POP M]** (pop music)...
 - ↳ Radio text message
 - ↳ Time

Select stereo/mono broadcast

 Note

- Stereo broadcast is the default setting for tuner mode.
- For stations with weak signals: to improve the reception, change to monaural sound.

In FM tuner mode, press ►|| to switch between mono and stereo broadcast.

6 Other features

Set the alarm timer

This unit can be used as an alarm timer. You can select disc, FM tuner, or USB as alarm source.

Note

- Make sure that you have set the clock correctly.

- 1 In standby mode, press and hold **TIMER** until **[SET TIMER]** (set timer) scrolls on the display.
- 2 Press **TIMER**.
↳ **[SELECT SOURCE]** (select source) scrolls on the display.
- 3 Press **SOURCE** repeatedly or the source selection buttons on the remote control to select a source: disc, FM tuner, or USB.
- 4 Press **TIMER** to confirm.
↳ The hour digits blink.
- 5 Press **◀▶** repeatedly to set the hour.
- 6 Press **TIMER** to confirm.
↳ The minute digits blink.
- 7 Repeat steps 5-6 to set the minute.

Note

- If no button is pressed in 90 seconds, the unit exits timer setting mode automatically.

To activate or deactivate the alarm timer,

In standby mode, press **TIMER** repeatedly to activate or deactivate the alarm.

- ↳  appears when the timer is activated.

Tip

- If CD/USB source is selected, but no disc is inserted or no USB connected, the unit switches to the tuner source automatically.

Set the sleep timer

Note

- Make sure that you have set the clock correctly.

When the unit is turned on, press **SLEEP** repeatedly to select the sleep timer period (in minutes).

- ↳ When sleep timer is activated, **zZ** is displayed.

Tip

- To deactivate the sleep timer, press **SLEEP** repeatedly until **[OFF]** (off) is displayed.

Play from external audio device

With this unit, you can play audio from an external audio device like MP3 player.

- 1 Connect the supplied MP3 Link cable to
 - the **MP3-LINK** socket.
 - the audio output socket of an external device.
- 2 Press **USB/MP3 LINK** repeatedly to select MP3 link mode.
- 3 Start to play the external device (see the device's user manual).

Listen through the headphone

Plug a headphone into the  socket on the unit.

7 Product information

Note

- Product information is subject to change without prior notice.

Specifications

Amplifier

Rated Output Power	2 X 10 W RMS
Frequency Response	80 Hz - 16 kHz, \pm 3 dB
Signal to Noise Ratio	\geq 60 dB
MP3 Link Input	0.5V RMS 20 kohm

Disc

Laser Type	Semiconductor
Disc Diameter	12 cm/8 cm
Support Disc	CD-DA, CD-R, CD-RW, MP3-CD, WMA-CD
Audio DAC	24 Bits/44.1 kHz
Total Harmonic Distortion	<1.5 % (1 kHz)
Frequency Response	60 Hz - 16 kHz
S/N Ratio	>55 dBA

Tuner (FM)

Tuning range	87.5 - 108 MHz
Tuning grid	50 KHz
Sensitivity	
- Mono, 26dB S/N Ratio	<22 dBf
- Stereo, 46dB S/N Ratio	>43 dBf
Search selectivity	>28 dBf
Total harmonic distortion	<3%
Signal to noise ratio	>50 dB
Number of presets	20

General information

AC power	Model: AS300-120-AI250; Input: 100 - 240V ~, 50/60 Hz, 1.1 A; Output: 12V=2.5 A
Operation Power Consumption	15 W
Standby Power Consumption	\leq 1 W
Dimensions	
- Main Unit (W x H x D)	400 x 235 x 98 mm
Weight	
- With Packing	3.5 kg
- Main Unit	2.1 kg

USB playability information

Compatible USB devices:

- USB flash memory (USB1.1)
- USB flash players (USB1.1)
- memory cards (requires an additional card reader to work with this unit)

Supported formats:

- USB or memory file format: FAT12, FAT16, FAT32 (sector size: 512 bytes)
- MP3 bit rate (data rate): 32-320 Kbps and variable bit rate
- WMA v9 or earlier
- Directory nesting up to a maximum of 8 levels
- Number of albums/ folders: maximum 99
- Number of tracks/titles: maximum 999
- ID3 tag v2.0 or later
- File name in Unicode UTF8 (maximum length: 16 bytes)

Unsupported formats:

- Empty albums: an empty album is an album that does not contain MP3/ WMA files, and is not be shown in the display.
- Unsupported file formats are skipped. For example, Word documents (.doc) or MP3 files with extension .dlf are ignored and not played.
- AAC, WAV, PCM audio files
- DRM protected WMA files (.wav, .m4a, .m4p, .mp4, .aac)
- WMA files in Lossless format

RDS program types

NO TYPE	No RDS programme type
NEWS	News services
AFFAIRS	Politics and current affairs
INFO	Special information programs
SPORT	Sports
EDUCATE	Education and advanced training
DRAMA	Radio plays and literature
CULTURE	Culture, religion and society
SCIENCE	Science
VARIED	Entertainment programs
POP M	Pop music
ROCK M	Rock music
MOR M	Light music
LIGHT M	Light classical music
CLASSICS	Classical music
OTHER M	Special music programs
WEATHER	Weather
FINANCE	Finance
CHILDREN	Children's programs
SOCIAL	Social Affairs
RELIGION	Religion
PHONE IN	Phone In
TRAVEL	Travel
LEISURE	Leisure
JAZZ	Jazz Music
COUNTRY	Country Music
NATION M	National Music
OLDIES	Oldies Music
FOLK M	Folk Music
DOCUMENT	Documentary
TES	Alarm Test
ALARM	Alarm

Supported MP3 disc formats

- ISO9660, Joliet
- Maximum title number: 999 (depending on file name length)
- Maximum album number: 99
- Supported sampling frequencies: 32 kHz, 44.1 kHz, 48 kHz
- Supported Bit-rates: 32~320 (kbps), variable bit rates

8 Troubleshooting

Warning

- Never remove the casing of this apparatus.

To keep the warranty valid, never try to repair the system yourself.

If you encounter problems when using this apparatus, check the following points before requesting service. If the problem remains unsolved, go to the Philips web site (www.philips.com/welcome). When you contact Philips, ensure that the apparatus is nearby and the model number and serial number are available.

No power

- Ensure that the AC power cord of the unit is connected properly.
- Ensure that there is power at the AC outlet.
- As a power-saving feature, the system switches off automatically 15 minutes after track play reaches the end and no control is operated.

No sound or poor sound

- Adjust the volume.
- Disconnect the headphones.

No response from the unit

- Disconnect and reconnect the AC power plug, then turn on the unit again.

Remote control does not work

- Before you press any function button, first select the correct source with the remote control instead of the main unit.
- Reduce the distance between the remote control and the unit.
- Insert the battery with its polarities (+/- signs) aligned as indicated.
- Replace the battery.
- Aim the remote control directly at the sensor on the front of the unit.

No disc detected

- Insert a disc.
- Check if the disc is inserted upside down.

- Wait until the moisture condensation at the lens has cleared.
- Replace or clean the disc.
- Use a finalized CD or correct format disc.

Cannot display some files in USB device

- The number of folders or files in the USB device has exceeded a certain limit. This phenomenon is not a malfunction.
- The formats of these files are not supported.

USB device not supported

- The USB device is incompatible with the unit. Try another one.

Poor radio reception

- Increase the distance between the unit and your TV or VCR.
- Fully extend the FM antenna.

Timer does not work

- Set the clock correctly.
- Switch on the timer:

Clock/timer setting erased

- Power has been interrupted or the power cord has been disconnected.
- Reset the clock/timer:

9 Notice

Any changes or modifications made to this device that are not expressly approved by Philips Consumer Lifestyle may void the user's authority to operate the equipment.



This product complies with the radio interference requirements of the European Community.

This product complies with the requirements of the following directives and guidelines: 2004/108/EC + 2006/95/EC



Your product is designed and manufactured with high quality materials and components, which can be recycled and reused.



When this crossed-out wheeled bin symbol is attached to a product it means that the product is covered by the European Directive 2002/96/EC.

Please inform yourself about the local separate collection system for electrical and electronic products.

Please act according to your local rules and do not dispose of your old products with your normal household waste. Correct disposal of your old product helps to prevent potential negative consequences for the environment and human health.



Your product contains batteries covered by the European Directive 2006/66/EC, which

cannot be disposed with normal household waste. Please inform yourself about the local rules on separate collection of batteries because correct disposal helps to prevent negative consequences for the environmental and human health.

Environmental information

All unnecessary packaging has been omitted. We have tried to make the packaging easy to separate into three materials: cardboard (box), polystyrene foam (buffer) and polyethylene (bags, protective foam sheet.)

Your system consists of materials which can be recycled and reused if disassembled by a specialized company. Please observe the local regulations regarding the disposal of packaging materials, exhausted batteries and old equipment.



**Be responsible
Respect copyrights**

The making of unauthorized copies of copy-protected material, including computer programs, files, broadcasts and sound recordings, may be an infringement of copyrights and constitute a criminal offence. This equipment should not be used for such purposes.

This apparatus includes this label:





© 2011 Koninklijke Philips Electronics N.V.
All rights reserved.
MCM2050_05_UM_V1.2

