

*it all
starts
with a
vision*

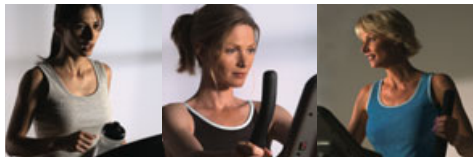

VISION  FITNESS®

500 South CP Avenue • P.O. Box 280 • Lake Mills, WI 53551
toll free 800.335.4340 • phone 920.648.4090 • fax 920.648.3373
www.visionfitness.com

©2006 Vision Fitness. All Rights Reserved. 11.06
AG18.47PRD
REV1

Assembly Guide

VISION  FITNESS®

E3700HRT
COMMERCIAL FITNESS BIKES

TOOLS & PARTS INCLUDED

5mm T-Shaped Wrench

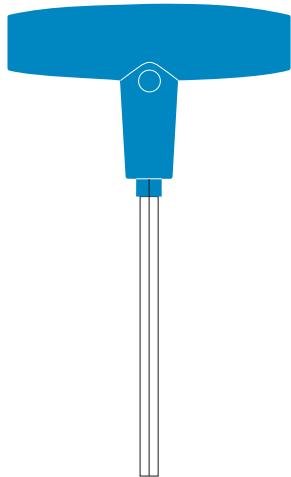

1.5mm Pedal Wrench

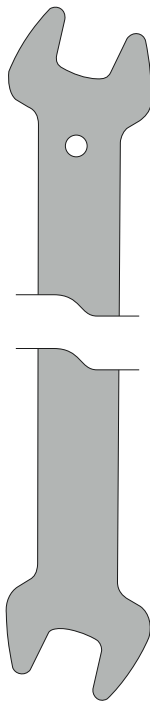

Screwdriver



PARTS BOX

Console Mast Cover
Accessory Tray
Water Bottle
Color-coded Hardware Bags
Owner's Guide
Assembly Guide
Warranty Card
Heart Rate Chest Strap

HARDWARE INCLUDED

ORANGE BAG

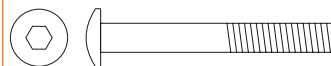

M8x6.5L Bolt
Quantity: 2



M8 x 20L Bolt
Quantity: 2



M8 Lock Washer
Quantity: 4

PINK BAG



M8 x 20L Bolt
Quantity: 4

BLUE BAG



M8 x 1.5L Bolt
Quantity: 7



M8 Lock Washer
Quantity: 6

Assembly Guide

E3700HRT COMMERCIAL FITNESS BIKE

To avoid possible damage to this Fitness Bike, please follow these assembly steps in the correct order. Before proceeding, find your new Fitness Bike's serial number located on the front axle tube, and enter here:

Refer to this number when calling for service, and enter this serial number on your Warranty Card and in your own records. Be sure to read your Owner's Guide before using your new Fitness Bike. If any parts, hardware or tools are missing, please call 1.800.335.4348, Extension 12

NOTE: It is recommended that you apply grease to the threads of each bolt and screw as you assemble your Fitness Bike to prevent loosening and noise. Also, during each assembly step, ensure that ALL screws and bolts are in place and partially threaded in before completely tightening any ONE screw or bolt.

STEP 1 ORANGE BAG

- Install the rear foot with four lock washers (M8), two inside bolts (M8x6.5L), and two outside bolts (M8x20L). Tighten with the 5mm T-shaped wrench.

STEP 2 BLUE BAG

- Slide the console mast boot onto the console mast.
- Unfold the wire harness located in the console mast frame bracket. Connect it to the wire tie coming from the bottom of the console mast. Pull the wire tie and wire harness up through the top of the console mast while simultaneously sliding the mast into the frame bracket.
- Secure the mast to the frame using six lock washers (M8) and six bolts (M8x1.5L). Tighten with the 5mm T-shaped wrench. Place the seventh bolt (M8x1.5L) in the rear of the frame bracket and tighten until snug.
- Slide the console mast boot down and set it in place on the side cover.
- Remove the nuts (M8) from the bottom of the seat. Attach the seat to the seat post with the nuts you just removed. Tighten with the 15mm wrench.

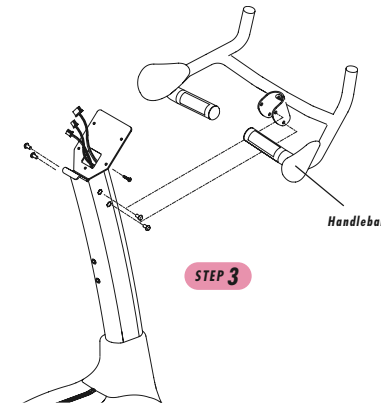
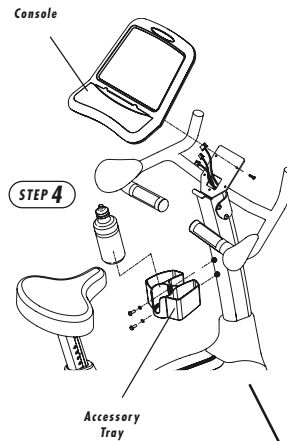
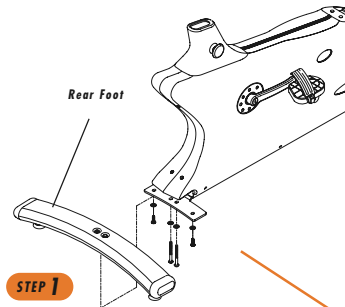

STEP 3 PINK BAG

- Feed the heart rate wires of the handlebar through the small hole located in the front of the console mast. Pull these wires up through the hole at the top of the console mast. Attach the handlebar to the console mast using four bolts (M8x20L). Tighten with the 5mm T-shaped wrench.

STEP 4 CONSOLE

- Remove the four mounting bolts from the back of the console with the screwdriver. Plug in the wire harness and the two heart rate wires to the back of the console. Attach the console to the console mast with the four bolts removed earlier in this step.
- Remove the battery cover on the backside of the console. Plug in the 9-volt battery. Reattach the battery cover.
- With the screwdriver, remove the two bolts located half way up the console mast. Attach the accessory tray to the console mast with the two bolts.

