

RS3697BL

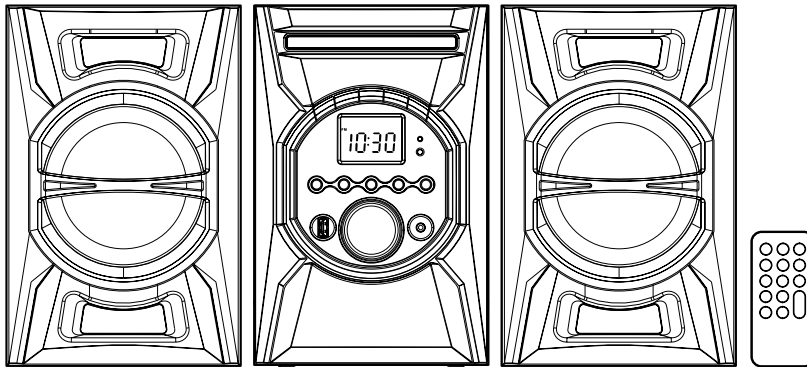

English (EN)

Español (E)

Français (F)



Scan for more user manual details

Lea para obtener más detalles sobre el manual del usuario

Scanner pour détails supplémentaires indiqués dans le manuel d'utilisation

CAUTION
INVISIBLE LASER RADIATION
WHEN OPEN AND INTERLOCKS DEFEATED.
AVOID EXPOSURE TO BEAM.

PRECAUCIÓN
RADIACIÓN LÁSER INVISIBLE EN CASO DE
APERTURA Y DESBLOQUEO DE CIERRE.
EVITE CUALQUIER EXPOSICIÓN AL RAYO.

MISE EN GARDE
RADIATION LASER INVISIBLE, SI L'APPAREIL
EST OUVERT ET SI LE DISPOSITIF DE
VERROUILLAGE EST NEUTRALISÉ.ÉVITER
L'EXPOSITION AU FAISCEAU LASER.

CLASS 1 LASER PRODUCT
PRODUCTO LÁSER CLASE 1
APPAREIL À LASER DE CLASSE 1



This product contains a low power laser device.

Este producto contiene un dispositivo láser de baja potencia.

Cet appareil contient un dispositif à laser de faible puissance.



Double insulation when servicing use only identical replacement parts.

Doble aislamiento. Al reparar sólo use piezas idénticas de repuesto.

Double isolation; en cas de réparation, utilisez seulement des pièces de rechange identiques

It's important to read this User Manual prior to using your new product for the first time.

Es importante leer este manual antes de usar por vez primera su equipo.

Il est important de lire ce manuel d'utilisation avant l'utilisation initiale de ce nouveau produit.

SAFETY PRECAUTIONS



WARNING:

- TO PREVENT FIRE OR SHOCK HAZARD, DO NOT EXPOSE THE UNIT TO RAIN OR MOISTURE.
- TO AVOID ELECTRICAL SHOCK, DO NOT OPEN THE CABINET. REFER SERVICING TO QUALIFIED PERSONNEL ONLY.
- THE APPARATUS SHALL NOT BE EXPOSED TO DRIPPING OR SPLASHING AND THAT NO OBJECTS FILLED WITH LIQUID, SUCH AS VASES, SHALL BE PLACED ON THE APPARATUS.

FCC STATEMENTS

This device complies with Part 15 of the FCC Rules. Operation is subject to the following two conditions: (1) This device may not cause harmful interference, and (2) This device must accept any interference received, including interference that may cause undesired operation.

This equipment has been tested and found to comply with the limits for a Class B digital device, pursuant to Part 15 of the FCC Rules. These limits are designed to provide reasonable protection against harmful interference in a residential installation. This equipment generates, uses and can radiate radio frequency energy and, if not installed and used in accordance with the instructions, may cause harmful interference to radio communications. However, there is no guarantee that interference will not occur in a particular installation. If this equipment does cause harmful interference to radio or television reception, which can be determined by turning the equipment off and on, the user is encouraged to try to correct the interference by one or more of the following measures:

- Reorient or relocate the receiving antenna.
- Increase the separation between the equipment and receiver.
- Connect the equipment into an outlet on a circuit different from that to which the receiver is connected.
- Consult the dealer or an experienced radio/TV technician for help.

WARNING: Changes or modifications not expressly approved by the party responsible for compliance could void the user's authority to operate the equipment.

For Customers in Canada

This device complies with Industry Canada License-exempt RSS-210. Operation is subject to the following two conditions: (1) this device may not cause interference, and (2) this device must accept any interference, including interference that may cause undesired operation of the device.

This apparatus complies with the Class B limits for radio noise emission set out in radio interference regulations.

CAN ICES-3 (B) / NMB-3 (B)

Warnings:

- The AC power plug is used as disconnect device and it should remain readily operable during intended use. In order to disconnect the apparatus from the mains completely, the AC power plug should be disconnected from the mains socket outlet completely.
- The mains plug of apparatus should not be obstructed OR should be easily accessed during intended use.
- Minimum 10 cm (4 inches) distances around the apparatus for sufficient ventilations.
- The ventilation should not be impeded by covering the ventilation openings with items such as newspaper, tablecloths, curtains, etc.
- No naked flame sources such as lighted candles should be placed on the apparatus.

 The lightning flash with arrowhead symbol, within an equilateral triangle, is intended to alert the user to the presence of uninsulated "dangerous voltage" within the product's enclosure that may be of sufficient magnitude to constitute a risk of electric shock to persons.

 The exclamation point within an equilateral triangle is intended to alert the user to the presence of important operating and maintenance (servicing) instructions in the literature accompanying the appliance.

On Safety

As the laser beam used in this compact disc player could be harmful to the eyes, do not attempt to disassemble the casing. Refer servicing to qualified personnel only.

- Do not put any foreign objects in the disc compartment. If you do so, the laser beam interlock may be defeated allowing the laser to remain on when the lid is opened.
- Should any objects or liquids fall into the unit, disconnect the power supply and have the unit checked by qualified personnel before any further operation.

On Operation

Since the CD system offers a wide dynamic range, the peaks of the high level inputs are recorded with high fidelity, and the noise level is very low. Do not turn up the volume while listening to a part of the disc with no audio signals or very low level inputs. If you do so, the speakers may be damaged when the peak level of the sound is played. The lens of the laser should be kept clean. Do not touch the lens. If you do so, the lens may be damaged and the unit will not operate correctly.

On Use

Never use the unit where it would be subject to:

- Heat sources such as radiators or air ducts.
- Direct sunlight.
- Excessive dust.
- Moisture or rain.
- Mechanical vibration or shock.
- Uneven surface.
- Do not place any heavy objects on top of the unit.
- When the unit is used with an AC power plug, do not wrap the unit in a cloth, blanket, etc. If you do so, the temperature inside and outside the unit may rise considerably, resulting in malfunctioning of the unit.
- If the unit is brought directly from a cold to a warm location, or is placed in a very damp room, the moisture may condense on the lens inside the unit. Should this occur, the unit will not operate. In this case, remove the disc and leave the unit in a warm place for several hours until the moisture evaporates.
- For the unit to operate at its best, it should not be subject to temperatures below 41°F (5°C) or above 95°F (35°C).

Additional safety information

- Apparatus shall not be exposed to dripping or splashing and no objects filled with liquids, such as vases, shall be placed on the apparatus.
- Always leave sufficient space around the product for ventilation. Do not place product in or on a bed, rug, in a bookcase or cabinet that may prevent air flow through vent openings.
- Do not place lighted candles, cigarettes, cigars, etc. on the product.
- Connect power plug only to AC power source as marked on the product.
- Care should be taken so that objects do not fall into the product.
- Do not attempt to disassemble the cabinet. This product does not contain customer serviceable components.

EN

IMPORTANT SAFETY INSTRUCTIONS

1. Read these instructions.
2. Keep these instructions.
3. Heed all warnings.
4. Follow all instructions.
5. Do not use this apparatus near water.
6. Clean only with dry cloth.
7. Do not block any ventilation openings. Install in accordance with the manufacturer's instructions.
8. Do not install near any heat sources such as radiators, heat registers, stoves, or other apparatus (including amplifiers) that produce heat.
9. Do not defeat the safety purpose of the polarized or grounding-type plug. A polarized plug has two blades with one wider than the other. A grounding type plug has two blades and a third grounding prong. The wide blade or the third prong are provided for your safety. If the provided plug does not fit into your outlet, consult an electrician for replacement of the obsolete outlet.
10. Protect the power plug from being walked on or pinched particularly at plugs, convenience receptacles, and the point where they exit from the apparatus.
11. Only use attachments/accessories specified by the manufacturer.
12. Use only with a cart, stand, tripod, bracket, or table specified by the manufacturer, or sold with the apparatus. When a cart is used, use caution when moving the cart/apparatus combination to avoid injury from tip-over.

Portable Cart Warning
13. Unplug this apparatus during lightening storms or when unused for a long period of time.
14. Refer all servicing to qualified service personnel. Servicing is required when the apparatus has been damaged in any way, such as the power-supply cord or plug is damaged, liquid has spilled or objects have fallen into the apparatus, the apparatus has been exposed to rain or moisture, does not operate normally, or has been dropped.

LOCATION OF CONTROLS

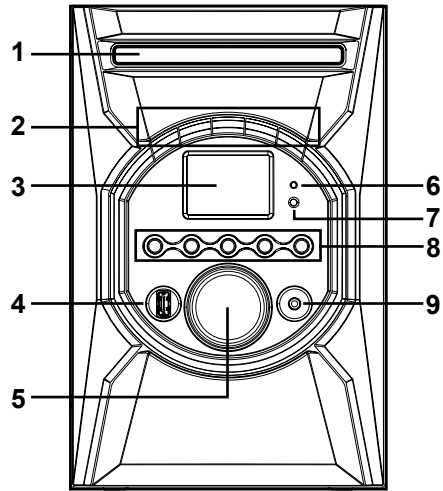

EN

- | | |
|-----------------------|-------------------------|
| 1. CD Door | 5. VOLUME control |
| 2. ◀◀ / TUNE - button | 6. Bluetooth® indicator |
| ▶▶ / TUNE + button | 7. Remote sensor |
| ▶▶ PLAY/PAIR button | 8. ⏻ STANDBY/ON button |
| ■ STOP button | ☀ / PRESET EQ button |
| ▲ OPEN / CLOSE button | ↺ / MEM.UP button |
| 3. LCD DISPLAY | ⌚ PROG/MEM button |
| 4. USB port | 📺 SOURCE button |
| (for charging only) | 9. Line in jack |

REMOTE CONTROL

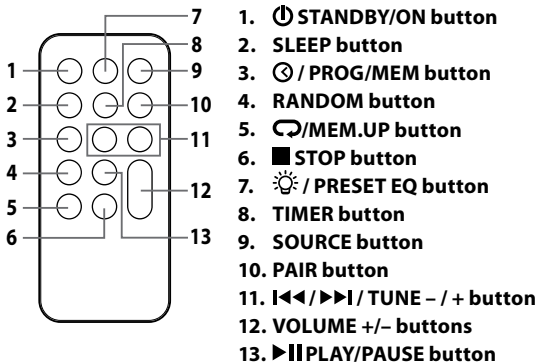

1. ⏻ STANDBY/ON button
2. SLEEP button
3. ⌚ / PROG/MEM button
4. RANDOM button
5. ↺/MEM.UP button
6. ■ STOP button
7. ☀ / PRESET EQ button
8. TIMER button
9. SOURCE button
10. PAIR button
11. ◀◀/▶▶ / TUNE - / + button
12. VOLUME +/- buttons
13. ▶▶|| PLAY/PAUSE button

BATTERY REPLACEMENT

When the battery becomes weak, the operating distance of the remote control is greatly reduced and you will need to replace it.

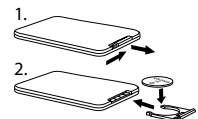
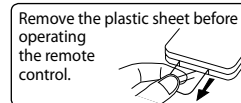

NOTE : If the remote control is not going to be used for a long time, remove the battery to avoid damage caused by battery leakage corrosion.

WARNING : Do not dispose of battery in fire; battery may explode or leak.

Batteries should not be exposed to excessive heat such as sunshine, fire or the like.

CAUTION : Danger of explosion if battery is incorrectly replaced. Replace only with the same or equivalent type.

⚠ WARNING DO NOT INGEST BATTERY. CHEMICAL BURN HAZARD.

The remote control supplied with this product contains a coin/button cell battery. If the coin/button cell battery is swallowed, it can cause severe internal burns in just 2 hours and can lead to death.

Keep new and used batteries away from children. If the battery compartment does not close securely, stop using the product and keep it away from children.

If you think batteries might have been swallowed or placed inside any part of the body, seek immediate medical attention.

SYSTEM CONNECTIONS

SPEAKER CONNECTIONS

Connect the speakers to the R terminal and the L terminal.

NOTE : Connecting speakers other than the speakers supplied with the unit may damage the unit.

CAUTIONS:

- Ensure that the power supply in your house complies with that indicated on the identification sticker located on the back of your unit. (AC 120V ~ 60Hz)
- If you are not going to use the unit for a long time, disconnect the AC power plug from the wall outlet.
- This unit is designed for continuous use. Switching off the unit to standby mode does not disconnect it from the power supply. To completely isolate the equipment, remove the plug from the wall outlet as some components remain connected to the electrical supply.
- **To prevent electrical shock, match wide blade of plug to wide slot of wall outlet, then fully insert.**

EN

CHARGE YOUR SMARTPHONE/TABLET

You can charge your smartphone/tablet through the USB socket with a USB cable (not supplied).

Connect a USB cable (not supplied) to the USB socket on the front of the unit and the dock connector on your smartphone/tablet.

LINE IN CONNECTION

You can connect audio devices such as your CD player or MP3 player to the unit via the LINE IN jack. To do this, connect an audio cable from the line out or headphone out jack of the other audio device to the LINE IN jack on the front of unit. Press the **SOURCE** button to switch to AUX mode.

Note : We recommend you unplug the device from the LINE IN jack when not in use.

CLOCK SETTING

Setting the clock can only be done in STANDBY mode.

- If the unit is plugged in with the supplied AC adapter and the unit is in standby mode.
1. Press and hold the **Ⓞ/PROG/MEM** button until the hour digits blink.
 2. Press the **◀▶** button to adjust the desired hours and press the **Ⓞ/PROG/MEM** button once to confirm, then the minute digits blink.
 3. Press the **◀▶** button to adjust the desired minutes and press the **Ⓞ/PROG/MEM** button once to start clock.

LISTENING TO THE RADIO

Press the **SOURCE** button to switch to TUNER mode.

Searching for a Station Automatically

- Press and hold the **◀▶** button until the tuner starts searching for a station, then release. After tuning in a station, the search stops.

Presetting Stations

1. Tune in to a desired station. Press the **Ⓞ/PROG/MEM** button.
2. The preset number will blink and the "MEM" indicator will be shown on the display.
3. Press the **Ⓞ/MEM.UP** button to select the preset number.
4. Press the **Ⓞ/PROG/MEM** button again to store it in memory.

Tuning in to a Preset Station

Press the **Ⓞ/MEM.UP** button to select a preset number.

Note : Do not connect the FM antenna to an outside antenna.

When the reception is good, the "STEREO" icon will appear on the display.

PLAYBACK VIA BLUETOOTH® ENABLED DEVICES

INITIAL DEVICE PAIRING AND CONNECTION

In order to pair and connect your Bluetooth® device for the first time:

1. Press the **SOURCE** button to Bluetooth® mode and "b ƚ" is shown on the display. The Bluetooth® indicator light glows blue and flashes which means the unit is in Bluetooth® mode and ready to pair.
2. Turn on the Bluetooth® device you wish to pair and connect.
3. Press and hold the **PAIR** button on the remote control for 3 seconds. The Bluetooth® indicator light will start flashing rapidly which means it is pairing.
4. On your Bluetooth® enabled device, search for the "RS3697BL" in the list of discovered devices and select it. It may take the unit and Bluetooth® enabled device a few seconds to pair.
5. When the Bluetooth® indicator glows a solid blue, the unit and the Bluetooth® enabled device are now paired and connected.
6. You can now enjoy audio from the unit.

Notes : If your Bluetooth device (e.g. Smart phone etc.) needs the PIN code while pairing, please enter 4-digit number: 0000.

The unit can only be connected to one Bluetooth® device at a time.

EN

RECONNECTING A BLUETOOTH® ENABLED DEVICE

Bluetooth® enabled devices must be reconnected when the device has been turned off or the unit has been turned off.

1. Turn on the Bluetooth® device that has already been paired with the unit.
2. Press the **SOURCE** button to Bluetooth® mode and "b ƚ" is shown on the display. The Bluetooth® indicator light glows blue and starts flashing rapidly, and it auto searches for the last paired Bluetooth® device in memory.
3. Depending on your Bluetooth® device, your device may automatically connect to the unit. If the device does not automatically connect to the unit, press and hold the **PAIR** button on the remote control for 3 seconds until the Bluetooth® indicator light starts flashing rapidly, then search for the "RS3697BL" in its list of your Bluetooth® devices and select it.
4. Once the Bluetooth® indicator turns a solid blue, the Bluetooth® enabled device is paired and connected.
5. You can now enjoy audio from the unit.

PAIR AND CONNECT WITH ANOTHER NEW DEVICE

In order to pair the unit to a new device, you must first disconnect the currently paired and connected Bluetooth® device from the unit.

1. On the currently paired and connected Bluetooth® device, select the "RS3697BL" from the list of currently paired and connected devices, and disconnect it. Please refer to your Bluetooth® enabled device User's Guide for direction on how to disconnect a device. Or turn off the Bluetooth® device.
2. Follow the Initial device pairing and connection instructions above.

CD PLAYBACK

1. Press the **OPEN/CLOSE** button to open the CD door. Place a disc in the center with the label side up and then press the **OPEN/CLOSE** button to close the CD door.
2. Press the **SOURCE** button to CD mode. "CD" appears and "-" blinks on the display. Then the total track no. is shown on the display.
3. Press the **▶|| PLAY/PAUSE** button to start playing.

REPEAT PLAYBACK

Repeat Current Track

Press the **◀/MEM.UP** button until "REP" blinks on the display. The current track will be played repeatedly.

Repeat the Entire CD

Press the **◀/MEM.UP** button until "REP ALL" stops blinking and remains on. All tracks will be played repeatedly.

Cancel Playback Mode

Press the **◀/MEM.UP** button until "REP" disappears.

RANDOM PLAYBACK

All tracks on the disc can be played in random order (Using the remote control only).

Random Playback

Press the **RANDOM** button on the remote control until "r" is shown on the display. All tracks will be played randomly. To cancel, press the **RANDOM** button on the remote control until "r" disappears.

PROGRAMMABLE CD PLAYBACK

A program of up to 20 tracks can be set to play in a preset order.

1. In CD stop mode, press the **Ⓞ/PROG/MEM** button and the "MEM" & "P 0 1" will blink on the display.
2. Press the **◀◀** or **▶▶** button to select the desired track and press the **Ⓞ/PROG/MEM** button to store the track in memory. To start playback, press the **▶▶PLAY/PAUSE** button.

EN

PRESET EQ

This system has four different equalizer settings to adjust the levels of bass and treble.

During playback, press the **PRESET EQ** button to select a desired music mode. Each time the **PRESET EQ** button is pressed, the music mode will be changed to the next one as follows: **0FF** → **r 0c (ROCK)** → **P 0 P** → **CLR (CLASSIC)**

TIMER SETTING

The timer function will turn the unit on at a preset time.

To set timer

1. In standby mode, press and hold the **TIMER** button on the remote control until the hour indicator blinks.
2. Press the **◀◀** / **▶▶** button to adjust the desired hours and press the **TIMER** button once to confirm, then the minute digits blink.
3. Press the **◀◀** / **▶▶** button to adjust the desired minutes and press the **TIMER** button once to confirm, then the TUNER indicator blinks.
4. Press the **◀◀** / **▶▶** button to choose whether the unit will wake up to "CD" or "RADIO" when the timer reaches the preset time, then press the **TIMER** button once to confirm.
5. Press the **◀◀** / **▶▶** button to adjust the volume, then press the **TIMER** button once to confirm.
 - For RADIO alarm, first tune in to a desired station.
 - For CD alarm, first press the CD button to CD mode and insert one CD into the unit.

To cancel, press the **TIMER** button on the remote control twice and the CD or RADIO indicator goes out.

SLEEP TIMER SETTING

The sleep timer automatically turns the unit off at a certain time.

1. While the unit is on, press the **SLEEP** button on the remote control and "90" appears on the display.
2. Press the **SLEEP** button repeatedly to select the desired sleep time as below:
0FF → **90** → **80** → **70** → **60** → **50** → **40** → **30** → **20** → **10**
3. After setting a desired sleep time, the "**SLEEP_zZZ**" appears on the display.
4. The unit will automatically turn off once it reaches the sleep time.
 - To clear the preset sleep time press the **SLEEP** button on the remote control to select "0FF" and the "**SLEEP_zZZ**" disappears on the display.

ILLUMINATED SPEAKERS

When the unit turns on, the speakers will light up with multi-color LEDs and interact with the music. Press and hold the **☾** button on the unit or remote control to turn the lights on/off.

LIMITED WARRANTY

AVC MULTIMEDIA (“AVC”) makes the following limited warranty. This limited warranty extends to the original consumer purchaser and is limited to non-commercial use of the product.

One Year Parts & Labor Warranty

AVC products purchased in the United States are warranted to be free from defects in materials or workmanship for a period of one year from the date of their original retail purchase. If the unit fails to conform to this warranty, we will service the product using new or refurbished parts and products, at **AVC’s** sole discretion.

During a period of one year from the effective warranty date, **AVC** will provide, when needed, service labor to repair a manufacturing defect at its designated Service Center. To obtain warranty service in the United States, you must first call our **Customer Support Center at 1-800-506-5746, during the hours listed in the box below.** The determination of service will be made by **AVC** Customer Support. **PLEASE DO NOT RETURN YOUR UNIT TO AVC WITHOUT PRIOR AUTHORIZATION.** New or remanufactured replacements for defective parts or products will be used for repairs by **AVC** at its designated Service Center for one year from the effective warranty date. Such replacement parts or products are warranted for an additional one year from the date of repair or replacement. The Customer will be required to ship the unit to the Service Center indicated at the time Customer Support is contacted to make the necessary repairs. The customer is responsible for all transportation charges to the service facility.

EN

Packaging and Shipping Instruction

When you send the product to the **AVC** service facility you must use the original carton box and packing material or an equivalent as designated by **AVC**.

Your Responsibility

- (1) You must retain the original sale receipt to provide proof of purchase.
- (2) These warranties are effective only if the product is purchased and operated in the U.S.A. or Canada.
- (3) Warranties extend only to defects in material or workmanship, and do not extend to any product or parts which have been lost or discarded, or damage to product or parts caused by misuse, accident, improper operation or maintenance, or use in violation of instructions provided with the product, or to product which has been altered or modified without authorization of **AVC**, or to products or parts thereof which have had the serial number removed or changed.

Out of Warranty

In the event your product requires repair after the limited warranty period has expired, please contact our Customer Support Center at **1-800-506-5746 or www.RCAav.com**

**Hours: Monday–Thursday: 9am–7pm, Friday: 9am–5pm,
Saturday: 9am–NOON Eastern time.**

Important: You are responsible for any transportation, shipping or insurance relative to the return of product to our Product Returns Center.

All warranties implied by state law, including the implied warranties of merchantability and fitness for a particular purpose, are expressly limited to the duration of the limited warranties set forth above. With the exception of any warranties implied by state law as hereby limited, the foregoing warranty is exclusive and in lieu of all other warranties, guarantees, agreements and similar obligations of manufacturer or seller with respect to the repair or replacement of any parts. In no event shall **AVC** be liable for consequential or incidental damages.

No person, agent, distributor, dealer or company is authorized to change, modify or extend the terms of these warranties in any manner whatsoever. The time within action must be commenced to enforce any obligation of **AVC** arising under the warranty or under any statute, or law of the United States or any state thereof, is hereby limited to one year from the date of purchase. This limitation does not apply to implied warranties arising under state law.

This warranty gives you specific legal rights and you may also have other rights, which may vary, from state to state. Some states do not allow limitation on how long an implied warranty lasts, when an action may be brought, or the exclusion or limitation of incidental or consequential damages, so the above provisions may not apply to you. For more information on other products and services, please visit our web site at **www.RCAav.com**

Important: Also keep your “Bill of Sale” as proof of purchase.

Model no Product name

Type of set Serial no

Invoice no Date purchased

Dealer name

FOR SERVICE AND REPAIR, PLEASE VISIT **www.RCAav.com**

Specifications and external appearance are subject to change without notice.

EN - 7