

The logo features the word "HIKVISION" in a bold, white, italicized sans-serif font. It is set against a red background that is a horizontal bar with a white diagonal line on the left side, creating a stylized, dynamic shape.

***HIKVISION***

**E Series Speed Dome  
User Manual**

UD.6L0201D1426A01

Thank you for purchasing our product. If there is any question or request, please do not hesitate to contact the dealer.

This manual is applicable to **E Series Speed Domes**.

This manual may contain several technically inaccurate points or printing errors, and the content is subject to change without notice. The updates will be added into the new version of this manual. We will readily improve or update the products or procedures described in the manual.

#### DISCLAIMER STATEMENT

“Underwriters Laboratories Inc. (“UL”) has not tested the performance or reliability of the security or signaling aspects of this product. UL has only tested for fire, shock or casualty hazards as outlined in UL’s Standard(s) for Safety, UL60950-1. UL Certification does not cover the performance or reliability of the security or signaling aspects of this product. UL MAKES NO REPRESENTATIONS, WARRANTIES OR CERTIFICATIONS WHATSOEVER REGARDING THE PERFORMANCE OR RELIABILITY OF ANY SECURITY OR SIGNALING RELATED FUNCTIONS OF THIS PRODUCT.

## Regulatory Information

### FCC Information

**FCC compliance:** This equipment has been tested and found to comply with the limits for a digital device, pursuant to part 15 of the FCC Rules. These limits are designed to provide reasonable protection against harmful interference when the equipment is operated in a commercial environment. This equipment generates, uses, and can radiate radio frequency energy and, if not installed and used in accordance with the instruction manual, may cause harmful interference to radio communications. Operation of this equipment in a residential area is likely to cause harmful interference in which case the user will be required to correct the interference at his own expense.

### FCC Conditions

This device complies with part 15 of the FCC Rules. Operation is subject to the following two conditions:

1. This device may not cause harmful interference.
2. This device must accept any interference received, including interference that may cause undesired operation.

### EU Conformity Statement



This product and - if applicable - the supplied accessories too are marked with "CE" and comply therefore with the applicable harmonized European standards listed under the Low Voltage Directive 2006/95/EC, the EMC Directive 2004/108/EC, the RoHS Directive 2011/65/EU.



2012/19/EU (WEEE directive): Products marked with this symbol cannot be disposed of as unsorted municipal waste in the European Union. For proper recycling, return this product to your local supplier upon the purchase of equivalent new equipment, or dispose of it at designated collection points. For more information see: [www.recyclethis.info](http://www.recyclethis.info).



2006/66/EC (battery directive): This product contains a battery that cannot be disposed of as unsorted municipal waste in the European Union. See the product documentation for specific battery information. The battery is marked with this symbol, which may include lettering to indicate cadmium (Cd), lead (Pb), or mercury (Hg). For proper recycling, return the battery to your supplier or to a designated collection point. For more information see: [www.recyclethis.info](http://www.recyclethis.info).



0301001040724



## Safety Instruction

These instructions are intended to ensure that the user can use the product correctly to avoid danger or property loss.

The precaution measure is divided into 'Warnings' and 'Cautions':

**Warnings:** Serious injury or death may be caused if any of these warnings are neglected.

**Cautions:** Injury or equipment damage may be caused if any of these cautions are neglected.

	
<b>Warnings</b> Follow these safeguards to prevent serious injury or death.	<b>Cautions</b> Follow these precautions to prevent potential injury or material damage.



### Warnings:

- Please adopt the power adapter which can meet the safety extra low voltage (SELV) standard. Refer to the specification manual for the standard of power adapter and the power consumption cannot be less than the required value.
- Do not connect several devices to one power adapter as an adapter overload may cause over-heating and can be a fire hazard.
- When the product is installed on a wall or ceiling, the device should be firmly fixed.
- To reduce the risk of fire or electrical shock, do not expose the indoor used product to rain or moisture.
- This installation should be made by a qualified service person and should conform to all the local codes.
- Please install blackouts equipment into the power supply circuit for convenient supply interruption.
- If the product does not work properly, please contact your dealer or the nearest service center. Never attempt to disassemble the product yourself. (We shall not assume any responsibility for problems caused by unauthorized repair or maintenance.)

**Cautions:**

- Make sure the power supply voltage is correct before using the product.
- Do not drop the product or subject it to physical shock. Do not install the product on vibratory surface or places.
- Do not expose it to high electromagnetic radiating environment.
- Do not aim the lens at the strong light such as sun or incandescent lamp. The strong light can cause fatal damage to the product.
- The sensor may be burned out by a laser beam, so when any laser equipment is being used, make sure that the surface of the sensor not be exposed to the laser beam.
- Do not place the dome in extremely hot, cold, dusty or damp locations, otherwise fire or electrical shock will occur. Refer to the Specification for the details of operating temperature.
- To avoid heat accumulation, good ventilation is required for a proper operating environment.
- While shipping, the product should be packed in its original packing.
- Please use the provided glove when open up the product cover. Do not touch the product cover with fingers directly, because the acidic sweat of the fingers may erode the surface coating of the product cover.
- Please use a soft and dry cloth when clean inside and outside surfaces of the product cover. Do not use alkaline detergents.
- Improper use or replacement of the battery may result in hazard of explosion. Please use the manufacturer recommended battery type.

# Table of Contents

<b>Chapter 1</b>	<b>Overview .....</b>	<b>6</b>
1.1	Description .....	6
1.2	Functions .....	6
<b>Chapter 2</b>	<b>Getting Started .....</b>	<b>9</b>
2.1	Power-up Action .....	9
2.2	Basic Operations .....	10
2.3	System-defined Presets .....	10
2.4	On-screen Displays .....	11
<b>Chapter 3</b>	<b>Menu Operation .....</b>	<b>12</b>
3.1	Accessing and Operating the Menu .....	12
3.2	Configuring System Information .....	13
3.2.1	Checking System Information .....	13
3.2.2	Configuring System Parameters .....	14
3.3	Configuring Image Parameters .....	19
3.3.1	Configuring Camera Parameters .....	19
3.3.2	Configuring Privacy Mask .....	24
3.4	Configuring PTZ Control Parameters .....	25
3.4.1	Configuring PTZ Parameters .....	26
3.4.2	Configuring Presets .....	28
3.4.3	Configuring Patrols .....	29
3.4.4	Configuring Patterns .....	30
3.4.5	Configuring Time Tasks .....	32
3.4.6	Configuring Zone .....	34
3.4.7	Clearing PTZ Control Settings .....	35
3.5	Others .....	36
3.5.1	Configuring Dome Authentication .....	36
3.5.2	Restoring Default Dome Settings .....	37
3.5.3	Restoring Default Camera Settings .....	38
3.5.4	Rebooting the Dome .....	38
<b>Appendix</b>	<b>.....</b>	<b>39</b>
Appendix 1	Lightning & Surge Protection .....	39
Appendix 2	RS485 Bus Connection .....	40
Appendix 3	24VAC Wire Gauge & Transmission Distance .....	43
Appendix 4	Table of Wire Gauge Standards .....	44

# Chapter 1 Overview

## 1.1 Description

Integrated with the built-in pan/tilt unit, the E series speed dome features highly sensitive response and reliable performance. The speed dome can be adopted in various surveillance fields with its full-integral functions and features, such as corridor, large venue, meeting room, station, neighborhoods, etc.

## 1.2 Functions



The functions vary according to the different models of the speed dome.

- **Coaxial Control**

The speed dome with a specified DVR or controller can be sent the control signals via coaxial cable (BNC cable).

- **Limit Stops**

The dome can be programmed to move within the limit stops (left/right, up/down).

- **Self-adaptive Protocol**

While using RS485 control, the speed dome is compatible with PELCO-D, PELCO-P and PRIVATE-Code, etc., and is capable of being self-adaptive to these protocols without selecting protocol by DIP switch settings. While using coaxial control, the speed dome is self-adaptive to PELCO-D and PRIVATE-Code protocols.

- **Keyboard Control**

The pan/tilt movement and zoom actions of dome can be controlled by the control keyboard, DVR, matrix, etc.

- **Scan Modes**

The dome provides 5 scan modes: auto scan, tilt scan, frame scan, random scan and panorama scan.

- **Preset Freezing**

This feature freezes the scene on the monitor when the dome is moving to a preset. This allows for smooth transition from one preset scene to another. It also guarantees that masked area will not be revealed when the dome is moving to a preset.

- **Presets**

A preset is a predefined image position. When the preset is called, the dome will automatically move to the defined position. The presets can be added, modified, deleted and called.

- **Label Display**

The on-screen label of the preset title, PT display, zoom, and time can be displayed on the monitor.

- **Auto Flips**

In manual tracking mode, when a target object goes directly beneath the dome, the video will automatically flips 180 degrees in horizontal direction to maintain continuity of tracking. This

function can also be realized by auto mirror image depending on different camera models.

- **Privacy Mask**

This function allows you to block or mask certain area of a scene, for preventing the personal privacy from recording or live viewing. A masked area will move with pan and tilt functions and automatically adjust in size as the lens zooms telephoto and wide.

- **3D Positioning**

In the client software, use the left key of mouse to click on the desired position in the video image and drag a rectangle area in the lower right direction, then the dome system will move the position to the center and allow the rectangle area to zoom in. Use the left key of mouse to drag a rectangle area in the upper left direction to move the position to the center and allow the rectangle area to zoom out.

- **Proportional Pan/Tilt**

Proportional pan/tilt automatically reduces or increases the pan and tilt speeds according to the amount of zoom. At telephoto zoom settings, the pan and tilt speeds will be slower than at wide zoom settings. This keeps the image from moving too fast on the live view image when there is a large amount of zoom.

- **Auto Focus**

The auto focus enables the camera to focus automatically to maintain clear video images.

- **Day/Night Auto Switch**

The speed domes deliver color images during the day. And as light diminishes at night, the speed domes switch to night mode and deliver black and white images with high quality.

- **Slow Shutter**

In slow shutter mode, the shutter speed will automatically slowdown in low illumination conditions to maintain clear video images by extending the exposure time. The feature can be enabled or disabled.

- **Backlight Compensation (BLC)**

If you focus on an object against strong backlight, the object will be too dark to be seen clearly. The BLC (Backlight Compensation) function can compensate light to the object in the front to make it clear, but this causes the over-exposure of the background where the light is strong.

- **Wide Dynamic Range (WDR)**

The wide dynamic range (WDR) function helps the camera provide clear images even under back light circumstances. When there are both very bright and very dark areas simultaneously in the field of view, WDR balances the brightness level of the whole image and provide clear images with details.

- **White Balance (WB)**

White balance can remove the unrealistic color casts. White balance is the white rendition function of the camera to adjust the color temperature according to the environment automatically.

- **Patrol**

A patrol is a memorized series of pre-defined preset function. The scanning speed between two presets and the dwell time at the preset are programmable.

- **Pattern**

A pattern is a memorized series of pan, tilt, zoom, and preset functions. By default the focus and iris are in auto status during the pattern is being memorized.

- **Power Off Memory**



The dome supports the power off memory capability with the predefined resume time. It allows the dome to resume its previous position after power is restored.

- **Time Task**

A time task is a preconfigured action that can be performed automatically at a specific date and time. The programmable actions include: pan scan, random scan, patrol 1-8, pattern 1-4, preset 1-8, frame scan, panorama scan, tilt scan, day, night, and none.

- **Park Action**

This feature allows the dome to start a predefined action automatically after a period of inactivity.

## Chapter 2 Getting Started

### 2.1 Power-up Action

After the speed dome is power-on, it will perform a series of self-test actions. It runs the pan checking firstly, then the tilt checking and the camera checking at last. After the power-up actions, the system information will be displayed for 2 minutes on the live view screen as shown below.

	DS-XXXXX-XX
SN	XXXXXXXX
ADDRESS	0
COM FORMAT	2400,8,1
PROTOCOL	SELF ADAPTIVE
VERSION	X.XX
HARDVERSION	X.XX
BUILD DATE	XX XX XX

Figure 2-1 System Information

Table 2-1 Descriptions of the System Information

System Info	Description
SN	The serial No. of the speed dome, which is unique.
ADDRESS	The default communication address of the speed dome.
COM Format	The communication settings of the speed dome, including baudrate (2400 by default), data bit (8 by default) and stop bit (1 by default)
PROTOCOL	It is for the communication with other devices.
FIRMWARE	The version of the firmware.
HARDWARE	The version of the hardware.
BUILD DATE	The date when the program of the software is compiled.



- You have to configure the address and the baudrate for the speed dome the same as those in the control devices.
- The speed dome is self-adaptive to the PELCO-D, PELCO-P, PRIVATE-Code, VICON, and KALATEL-312 protocols.

## 2.2 Basic Operations

You can operate the speed dome using a control device, including the control keyboard, DVR, DVS, etc. In this manual, accessing the speed dome via the web browser will be taken as an example.

### Panning and tilting:

Click the direction buttons to control the pan and tilt movement of the speed dome.

### Zooming:

Click the **ZOOM+** and **ZOOM-** buttons to control the zooming.

### Focusing:

Click the **FOCUS+** and **FOCUS-** buttons to adjust the focus.

### Iris:

Click the **IRIS+** and **IRIS-** buttons to adjust the iris.

## 2.3 System-defined Presets

### Purpose:

The section lists the system-defined presets with special functions. These presets cannot be edited but can be only called through a control device, e.g. a DVS or web browser. To call the system-defined presets remotely, you can choose the preset number from the list in the PTZ control panel. Please refer to table below for details.

For instance, preset 99 is the “Start auto scan”. If you call the preset 99, the speed dome starts auto scan function.

Table 2-2 System-defined Presets

Preset NO.	Function	Preset NO.	Function
33	Auto-flip	93	Set manual limit stops
34	Return to home position	94	Remote reboot
35	Patrol 1	95	Access main menu
36	Patrol 2	96	Stop scanning
37	Patrol 3	97	Start random scanning
38	Patrol 4	98	Start frame scanning
39	IR cut filter in	99	Start auto scanning
40	IR cut filter out	100	Start tilt scanning
41	Pattern 1	101	Start panorama scanning
42	Pattern 2	102	Patrol 5
43	Pattern 3	103	Patrol 6
44	Pattern 4	104	Patrol 7
46	Enable fast patrol	105	Patrol 8
92	Enable limit stops		



For Manchester code control protocol, the system-defined presets with special functions are shown as below:

Table 1-1 System-defined Presets of Manchester Code Control Protocol

Set Preset NO.	Function	Call Preset NO.	Function
65	Remote reboot	67	Auto-flip
66	Access main menu	70	Run Pattern 1
69	Stop recording pattern	71	Run Pattern 2
70	Record Pattern 1	72	Run Pattern 3
71	Record Pattern 2		
72	Record Pattern 3		

## 2.4 On-screen Displays

The speed dome supports following on-screen displays:

**Zoom Show:** Identifies the amount of magnification. The format is ZXXX. XXX is the zoom amount.

**PT Show:** Displays panning and tilting direction, with the format of NEXXX/TXXX. The NE followed with XXX indicates the degrees in north east direction, while the T followed with XXX indicates the degrees in tilt position.

**Time Show:** Displayed as Day/Month/Year/Day of Week/Hour/Minute. It supports 24-hour time system.

**Preset Show:** After you call the configured preset, the preset number is displayed if the lens moves to the certain place where you've set a preset for.

**Zone Show:** Display the zone title.

**Address Show:** Display the address of the speed dome.

**Error Rate Show:** Display the error rate of the speed dome.

**Fan and Heat show:** Display the heat information of the speed dome.

## Chapter 3 Menu Operation



- The operation interface of the different speed domes may differ. Please refer to the actual operation interface.
- You can click the left and right direction buttons in the PTZ control panel via the web browser of the DVR to enter the next page or return to the previous page of the submenu if more than one page is available.

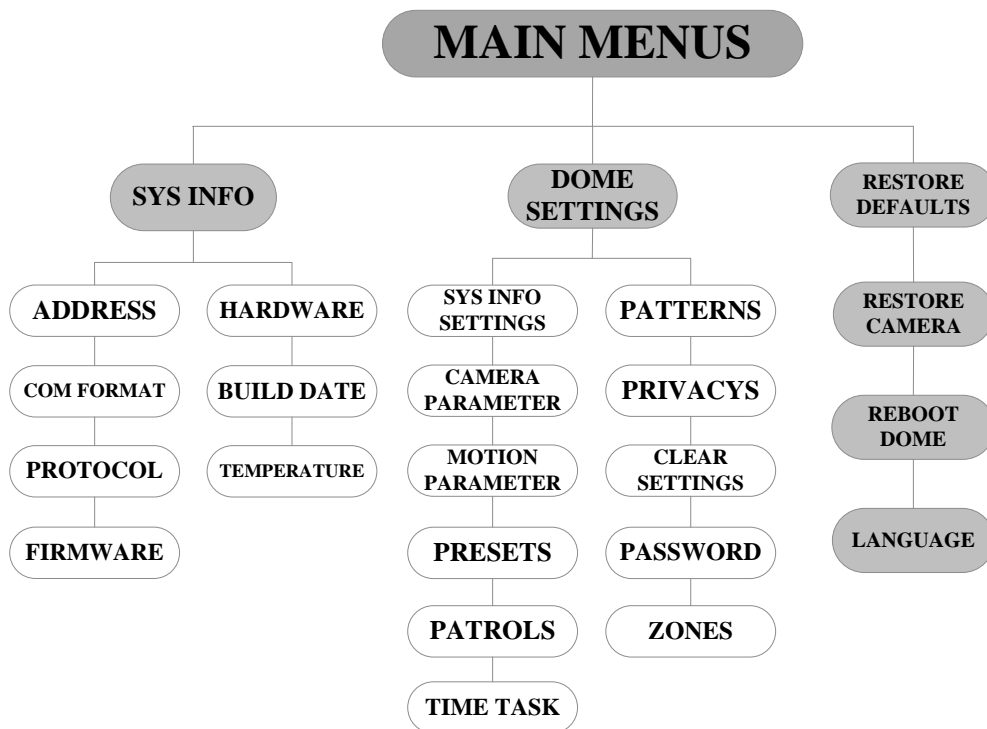

Figure 3-1 Main Menu

### Before you start:

You can operate the speed dome using the on-screen display menu remotely by connecting to a DVR or a DVS (encoder).

### Examples of entering speed dome menu are listed as follows:

- Enter the menu by pressing buttons: **PTZ -> REC -> 9 -> 5** on the front panel of the DVR.
- Enter the menu by pressing buttons: **CALL -> 9 -> 5 -> ENTER** on the keyboard.
- Enter the menu via the web browser of a DVR/DVS.

Menu operations via the web browser of a DVR will be taken as an example in this chapter.

## 3.1 Accessing and Operating the Menu

### To enter the main menu:

#### Steps:

1. Connect the video and RS-485 cables of speed dome to a DVR.

2. Visit the DVR via the web browser.
3. View the live video of the speed dome.
4. For PELCO-P/D and other private PTZ protocols, call preset 95 from the preset list in the PTZ control panel of the DVR.
5. For some other protocols, e.g. Manchester code control protocol, call preset 66 to access the menu. Please refer to Table 2-3 for details.

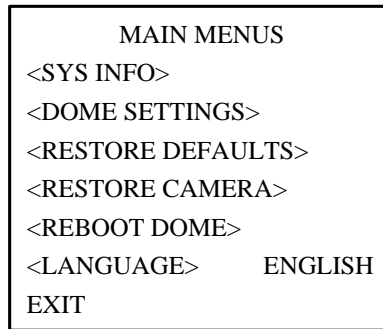

Figure 3-2 Main Menu

**To move the cursor and operate the menu:**

- Move the cursor up/down: On the live view page of the web browser, click up/down direction buttons or **FOCUS +** and **FOCUS -** buttons in the PTZ control panel to move the cursor up and down.
- Enter/Exit: On the live view page of the web browser, click **IRIS+** to enter a submenu; move the cursor to **Exit** and click **IRIS+** to exit.

**To change the value of a parameter:****Steps:**

1. Move the cursor to the target item and click **IRIS+** button. You can see the shape of cursor changes.
2. Click the up/down or left/right buttons in the PTZ control panel to choose the value from the selectable value list.
3. Press **IRIS+** to confirm the change or click **IRIS-** to cancel and restore the original value. You can see the shape of cursor changes again.

## 3.2 Configuring System Information

### 3.2.1 Checking System Information

**Purpose:**

System information menu displays the current system information of the speed dome, including model, address, protocol, etc. The information shown on this submenu is similar to the system information shown after the power-up action. Please refer to *Section 2.1* for more details.

Enter the system information display menu:

**MAIN MENUS > SYS INFO**

SYS INFO		SYS INFO	
DS-XXXXX-X		TEMPERATURE	38
ADDRESS	0		
COM FORMAT	2400,8,1		
PROTOCOL	SELF ADAPTIVE		
VERSION	1.00		
HARDVERSION	1.00		
BUILD DATE	13 04 01		
BACK	EXIT	BACK	EXIT

Figure 3-3 System Information



- Information on this menu cannot be edited.
- The temperature refers to the internal temperature of the speed dome.

**3.2.2 Configuring System Parameters****Purpose:**

You can check and also edit the system information of software address, baud rate, system time, etc. on the system information settings menu.

**MAIN MENUS > DOME SETTINGS > SYS INFO SETTINGS**

SYS INFO SETTINGS		SYS INFO SETTINGS		SYS INFO SETTINGS	
SOFT ADDRESS	1	ZERO ANGLE		PROTOCOL STATUS SET	OFF
SOFT ADDR ACTIVE	OFF	DISPLAY SETTINGS		PROTOCOL SET	AUTO MATCH
SOFT BAUD	2400	IR PARAMETER		485CHECK SET	AUTO
SOFT BAUD ACTIVE	OFF	FAN CONTROL	N/A	POWER MEMORY	180S
BROADCAST ADDRESS	ON	EIS FUNCTION	OFF	NEAR FOCUS LEVEL	1
PELCO CHECKSUM	ON	EIS LEVEL	N/A	COAXITRON ACTIVE	ON
SYS TIME		PRESET DFOCUS	OFF		
BACK	EXIT	BACK	EXIT	BACK	EXIT

Figure 3-4 System Information Settings



You can click the left and right direction buttons in the PTZ control panel via the web browser of the encoder to enter the next page and return to the previous page of the submenu if more than one page is available.

- **Dome address settings**

**To Set the Soft Address of the Speed Dome**

If the **SOFT ADDR ACTIVE** is set as **ON**, the soft address is the valid address for connecting the speed dome. The selectable soft address range is from 1 to 255;

If the **SOFT ADDR ACTIVE** is set as **OFF**, the hard address set by the DIP switch is the valid address of the speed dome.



- Before you set the soft address of the speed dome, you need to confirm that it is within the control range of the control device (e.g. the DVR).
- After you enable/disable the soft address, the speed dome will reboot automatically to activate the settings.

### To Set the Broadcast Address of the Speed Dome

When the **BROADCAST ADDRESS** is set to **ON**, the control device with address 0 is capable of controlling all domes connected to it.

### ● Soft Baud Rate Settings

If the **SOFT BAUD ACTIVE** is set as **ON**, the soft baud rate is the valid baud rate for the speed dome, with 2400, 4800, 9600 and 19200 selectable.

If the **SOFT BAUD ACTIVE** is set as **OFF**, the baud rate should be set by the DIP switch.



After you enable/disable the soft baud rate, the speed dome will reboot automatically to activate the settings.

### ● PELCO Checksum

The PELCO CHECKSUM is used for Pelco-P and Pelco-D protocols. If the video turns to slack or uncontrollable, you can set the **PELCO CHECKSUM** as **ON** to improve the video quality.

### ● System Time Configuration

#### Steps:

- (1) Move the cursor to **SYS TIME** using the direction buttons and click **IRIS+** to enter.
- (2) Click the left/right direction buttons to position the cursor on the specific item (year/month/day or hour/minute/second) of which you want to change the value.
- (3) Click the up/down direction buttons to increase/decrease the value.
- (4) Click **IRIS+** button to confirm the settings and exit.

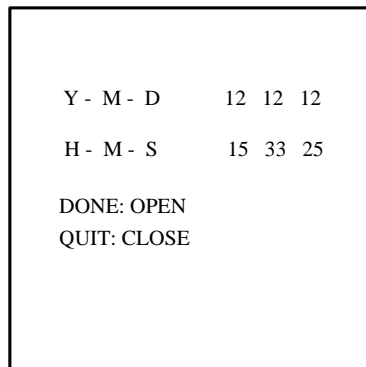

Figure 3-5 Set the System Time



## ● Zero Angle (Initial Position) Configuration

### **Purpose:**

You can define the initial position of the speed dome on the **ZERO ANGLE** submenu.

### **Steps:**

- (1) Move the cursor to **ZERO ANGLE** using the direction buttons and click **IRIS+** to enter.
- (2) Click the left/right/up/down direction buttons to adjust the monitor angle of the speed dome.
- (3) Click **IRIS+** button to confirm the settings and exit.

## ● Display Settings

### **Purpose:**

You can enable or disable the on-screen display of PTZ movements, alarms, time, presets, zone, address, error rate, and fan/heat show, etc.

### **Steps:**

- (1) Move the cursor to **DISPLAY SETTINGS** using the direction buttons and click **IRIS+** to enter.
- (2) Move the cursor to the target item and click **IRIS+** and click up/down direction buttons to choose each display mode as **ON** or **OFF**, and define each display time as 2 seconds, 5 seconds or 10 seconds.
- (3) Click **IRIS+** button to confirm the settings.



If you enable the OSD for both **ZOOM** and **PT**, while calling a preset, the preset No. will be displayed on the screen till the preset scene passes.

DISPLAY SETTINGS		DISPLAY SETTINGS	
ZOOM SHOW	2	FAN AND HEAT SHOW	OFF
PT SHOW	2		
TIME SHOW	ON		
PRESET SHOW	ON		
ZONE SHOW	ON		
ADDRESS SHOW	ON		
ERROR RATE SHOW	ON		
BACK	EXIT	BACK	EXIT

Figure 3-6 Display Settings

The speed dome shows the viewing direction when you manually control it to rotate.

Table 1-2 Viewing Direction Display

Display	N	NE	E	SE	S	SW	W	NW
Indication	North	Northeast	East	Southeast	South	Southwest	West	Northwest



The north direction refers to the zero angle (initial position).

## ● IR Parameter Configuration



The IR parameters setting is supported by IR speed domes only.

**Purpose:**

You can configure the IR parameters including the IR sensitivity, n/m LED current, reference height, reference zoom, and LED control, fan control, switch delay, heat control, and IR correction, etc.

Enter the LED parameter submenu:

**MAIN MENU > DOME SETTINGS > SYS INFO SETTINGS > IR PARAMETER**

IR PARAMETER		IR PARAMETER	
IR SENSITIVITY	MEDIUM	FAN CONTROL	TEMP
N/M LED CURRENT	8	SWITCH DELAY(SEC)	8
FAR LED CURRENT	8	HEAT CONTROL	TEMP
REFERENCE HEIGHT	4	IR CORRECTION	N/A
REFERENCE ZOOM	5		
LED CONTROL	CLOSE		
BACK	EXIT	BACK	EXIT

Figure 3-7 IR Parameter

- ◆ Set the sensitivity of the IR LED.  
You can set the **IR SENSITIVITY** to **HIGH**, **MEDIUM**, or **LOW**.
- ◆ Set the electricity level of the IR LED.  
The **N/M LED CURRENT** and the **FAR LED CURRENT** refer to the electricity level of the near/middle IR LED and far IR LED correspondingly. You can set the near/far LED current and the far LED current to **1~10**.
- ◆ IR LED switching settings
  - **REFERENCE HEIGHT.**  
Reference height refers to the mounting height of the speed dome. This value is for switching between near/medium-distance IR LED and far-distance IR LED.
  - **REFERENCE ZOOM.**  
When the actual zooming rate is larger than the reference zoom, it will switch to the far-distance IR LED; when it's smaller than the reference zoom, it will switch to the near/medium-distance IR LED.
  - **LED CONTROL.**  
LED control can be set to **ALL ON** (enable all the IR LED), **FAR ON** (enable far-distance IR LED), **NEAR ON** (enable near/medium-distance IR LED), **AUTO** (enable IR LED automatically according to the environment illumination), **ICR** (adjust the IR LED working mode according to the ICR), and **CLOSE** (disable IR LED).
- ◆ IR LED switch delay  
The **SWITCH DELAY (SEC)** refers to the delay time between the switch of far-distance IR LED and N/M-distance IR LED.
- ◆ Fan and heat settings

- **FAN CONTROL** is for adjusting the temperature of the speed dome's circuit board. You can set it to **ON** (normally on), **OFF** (normally off) or **TEM** (change according to the temperature).
- **HEAT CONTROL** is also to control the temperature of the speed dome in severe cold surveillance environments, which can be set as **ON** (normally on), **OFF** (normally off) or **TEM** (change according to the temperature).

#### ◆ IR correction settings

This parameter is to correct the focus problems caused by the IR light. You can turn **IR CORRECTION ON** or **OFF**.



IR correction settings vary according to the different camera models.

#### ● Fan Parameter Configuration

You can set the **FAN CONTROL** as **TEMP** (controlled by the temperature), **ON** or **OFF**.

#### ● EIS (Electronic Image Stabilization) Configuration

You can set the **EIS FUNCTION** as **ON** or **OFF**; and set the **EIS LEVEL** as 0-3.



The selectable EIS level varies according to the different camera models.

#### ● Preset Direct Focus

You can set the preset direct focus function **ON/OFF** on **PRESET DFOCUS** submenu.

#### ● Protocol and RS-485 settings

- Select the protocol.

Choose the protocol on **PROTO SET** submenu. You can configure it as **AUTO MATCH**, **PELCO-P**, **PELCO-D**, **HIKVISION**, **KALATEL** or **VICON**. When you choose **AUTO MATCH**, it is protocol self-adaptive.

- Set the protocol status.

Set the **PROTOCOL STATUS SET** as **ON** to enable the user-defined protocol.

- Enable the RS-485 configuration diagnosis.

You can set **485CHECK SET** as **ON** or **AUTO** for automatic RS-485 configuration diagnosis. If the configuration is incorrect, an alert will be received; if you set the value as **AUTO**, it will automatically stop the diagnosis when no errors exist.

#### ● Power Memory Settings

The dome can resume its previous PTZ status or actions after it restarted from a power-off. You can set the power memory to 10S, 30S, 60S, 180S, and 300S.

#### ● Near Focus Level

When the Focus Limit is set as **Auto**, you can configure the value of the Near Focus Level to adjust

minimum focus distance. The level can be set as 0, 1 and 2.

### ● Coaxitron Settings

The Coaxitron transmission function can be enabled to transmit the RS485 signal along with the video signal via the BNC cable. If the connected encoding device supports the Coaxitron transmission as well, the RS485 cable will not be necessary.

## 3.3 Configuring Image Parameters

### 3.3.1 Configuring Camera Parameters

#### **Purpose:**

You can set the camera parameters including focus, shutter speed, iris, etc.

Enter the camera parameters settings menu:

**MAIN MENU > DOME SETTINGS > CAMERA PARAMETER**

CAMERA		CAMERA	
FOCUS	AF	BLC/WDR	OFF
ZOOM LIMIT	22	BLC LEVEL	N/A
ZOOM SPEED	HIGH	AE MODE	AUTO
SLOW SHUTTER	ON	IRIS	10
IRCUT FILTER	AUTO	SHUTTER	50
D/N LEVEL	1	GAIN	N/A
SHARPNESS	8	EXPOSURE COMP	7
BACK	EXIT	BACK	EXIT
CAMERA		CAMERA	
WHITE BALANCE	AUTO	WIDE LIMIT	2.0
RED	210	CHROMA SUPPRESS	1
BLUE	150	SATURATION	1
IMAGE FLIP	OFF	CONTRAST	OFF
FOCUS LIMIT	1M	HLC	ON
INIT LENS	OFF	HR MODE	OFF
NOISE REDUCE	LOW	GAIN LIMIT	15
BACK	EXIT	BACK	EXIT

Figure 3-8 Camera Settings

**Task 1:** Configure the focus settings.

- Setting the focus mode

#### **Steps:**

- (1) Move the cursor to **FOCUS** using the direction buttons and click **IRIS+** to enter.
- (2) Click up/down direction buttons to set the focus mode to **AF**, **MF** or **HAF**.

**AF** (Auto-focus): The lens remains in focus during PTZ movements.

**MF** (Manual Focus): You need to adjust the focus with **Focus+** and **Focus-** buttons manually.

**HAF** (Half-auto Focus): The speed dome focuses automatically only once after panning, tilting and zooming.

(3) Click **IRIS+** button to save the settings.

- Setting the focus limit

**Purpose:**

This function is used to limit the minimum focus distance. You can configure the focus limit longer when the target is at a distance, to avoid the speed dome focusing on the objects close to it; or configure the focus limit shorter when the target is near the speed dome, and avoid it focuses on the objects father.

You can set **FOCUS LIMIT** to **1CM**, **30CM**, **1M**, **3M**, **5M** and **AUTO** to make sure that the speed dome focuses on the target.



The focus limit value varies according to the models of speed dome.

**Task 2:** Configure the zoom settings.

- Setting the zoom limit

**Purpose:**

Zoom limit is a user-defined limitation of the zoom amount (Zoom amount=optical zoom× digital zoom). If you set the zoom limit to the minimum value, the digital zoom will be invalid and the optical zoom will reach the maximum value; if you set the zoom limit smaller, the digital zoom will be enabled.

**Steps:**

- (1) Move the cursor to **ZOOM LIMIT** using the direction buttons and click **IRIS+** to enter.
- (2) Click up/down direction buttons to choose the limit from 22, 44, 88, 176, and 352.
- (3) Click **IRIS+** button to confirm.



If you set the **ZOOM LIMIT** as the minimum value 22, the digital zoom function will be disabled, and the optical zoom function is at its maximum value.

- Configure the zoom speed.

**Purpose:**

You can define the speed at which the lens changes from full wide zoom to the optical zoom.

**Steps:**

- (1) Move the cursor to **ZOOM SPEED** using the direction buttons and click **IRIS+** to enter.
- (2) Click up/down direction buttons to choose the speed from **HIGH** (default), **MEDUIM** and **LOW**.
- (3) Click **IRIS+** button to confirm.

**Task 3:** Configure the Day/Night mode.

There are two parameters available for day/night mode configuration.

- (1) IR cut filter. It can be set as **AUTO**, **DAY** or **NIGHT**.

**AUTO:** The speed dome is capable of automatically switching from Black and White mode

(NIGHT) and Color mode (DAY) regarding to the lightening conditions. It is the default mode.

**NIGHT (B/W):** You can switch the IR cut filter into Black and White mode to increase then lens sensitivity in low light conditions

**DAY (Color):** You can switch it to DAY mode in normal lighting conditions.



- You can set the **IRCUT FILTER** value on this menu, and you can call preset 39 to set the IR cut filter mode to **DAY** mode and call preset 40 to set it as **NIGHT** mode.
- The IRCUT FILTER value cannot be configured unless the IR light is turned off.

(2) D/N level. The D/N level is the light level for auto D/N mode switch. As a dividing line, IR cut filter switches between DAY and NIGHT when the light condition reaches the user-defined D/N level. Three levels are selectable: **HIGH**, **MID** (default) and **LOW**.



D/N level configuration varies according to the different camera models. Some models don't support user-defined D/N level.

**Task 4:** Configure the sharpness level.

The sharpness function can increase the gain of the image and sharpen the edges in the picture to enhance the picture details. You can set the **SHARPNESS** level from 0 to 15.

**Task 5:** Configure the BLC and WDR.

There are two parameters available for BLC and WDR configuration on this menu.

- (1) **BLC/WDR.** You can set the value as **ON** or **OFF** to enable or disable the functions.
- (2) **BLC LEVEL.** You can manually adjust the backlight compensation level.



BLC level configuration varies according to the different camera models. Some models don't support user-defined BLC level.

**Task 6:** Configuring the iris, gain and shutter speed

- **Set the AE Mode**

**Purpose:**

AE mode defines the priority of iris, shutter and gain while the speed dome adjusting the brightness of the live view. You can change the mode on **AE MODE** submenu.

**AUTO:** Auto iris, auto shutter and auto gain. The speed dome adjusts the values automatically responding to the lighting conditions. It is the default mode.

**HAUTO:** Half-auto mode allows you to adjust the iris manually while the camera is actually adjusting the exposure automatically. **HAUTO** mode will switch to **AUTO** mode automatically if there's no iris adjustment within 20 seconds, or when the lighting changes in the environment.

**IRIS:** User-defined iris value, auto shutter and auto gain. It is the iris-priority mode. Please define the iris value according to related content in this section if you choose **IRIS** mode.

**SHUTTER:** User-defined shutter speed, auto iris and auto gain. It is the shutter-priority mode. Please define the shutter speed according to related content in this section if you choose **SHUTTER** mode.

**MANUAL:** User-defined iris, gain and shutter. Please define the iris value, gain value and shutter speed according to related content in this section if you choose **MANUAL** mode.

### ● Set the Iris Value

The **IRIS** value measures the amount of light entering to the lens. You can set the iris value from 0 to 17 in response to the changing light conditions.



Iris is fully closed at value 0 and fully open at value 17.

### ● Set the Gain

1. Gain value. The value of gain indicates the amplification degree of the original image signal. You can set the value from 0 to 15.

2. Gain limit. The higher gain value you set, the more noises will appear in the image. You can set the maximum user configurable gain value from 0 to 15 to limit the gain range and control the noises in the image.



You need to change the **IRCUT FILTER** as **DAY** or **NIGHT** mode, and set the **AE MODE** as **MANUAL** before you adjust the gain value.

### ● Set the Shutter

#### **Purpose:**

The speed of the electronic shutter controls the amount of light entering to the lens in a unit of time (a second). You can manually configure the shutter speed for the speed dome, and you can also enable the slow shutter function for low lighting circumstances.

(1) Shutter speed. The larger you set the **SHUTTER** value (the faster the shutter speed is), the fewer the amount of entering light per second is, and the darker the image is. You can set the value as 1, 2, 4, 8, 15, 30, 50, 125, 180, 250, 500, 1000, 2000, 4000 or 10000.



The value of X indicates that the shutter speed is 1/X second. If you set the **SHUTTER** value bigger (shutter speed is faster), the amount of entering light per second is fewer, and the image is darker.

(2) Slow shutter. Set **SLOW SHUTTER** as **ON**, the shutter speed can automatically slow down to extend exposure time under low lighting circumstances to obtain clearer image.

#### **Task 7:** Configure exposure compensation.

You can set the **EXPOSURE COMP** value from 0 to 14. The default value is 7. You can adjust this value to increase the brightness of the image.

#### **Task 8:** Configure white balance.

You can set **WHITE BALANCE** mode as **AUTO**, **INDOOR**, **OUTDOOR**, **SELFDEF** (self-defined), **ATW** (auto-tracking) and **HAUTO** (half-auto).

**AUTO:**

In Auto mode, the dome retains color balance automatically according to the current color temperature.

**INDOOR, OUTDOOR:**

These two modes are for indoor use and outdoor use respectively.

**SELFDEF:**

In this mode, you can adjust the color temperature manually to meet your own demand.



In **SELFDEF** mode, you need to adjust the **RED** and **BLUE** values manually.

**ATW:**

In auto-tracking mode, white balance is continuously being adjusted in real-time according to the color temperature of the scene illumination.

**HAUTO:**

Selecting this mode, the viewed image retains color balance automatically according to the current color temperature.

**Task 9:** Configure the image flip.

If you turn the **IMAGE FLIP** function on, the image will be flipped diagonally along its central axis, shown as the mirror reflection of the image.

**Task 10:** Configure the INIT LENS.

You can turn **INIT LENS** on to trigger a spontaneous lens initiation to ensure the normal operation.

**Task 11:** Configure the noise reduction.

To reduce the image noise, you can set the **NOISE REDUCE** to LOW, HIGH, MIDDLE, and OFF.

**Task 12:** Configure the image quality.● **Wide Limit**

Set the wide limit ON can limit the minimum zoom of the lens.



The wide limit function is supported by certain camera model series.

● **Chroma Suppress**

Set the Chroma suppress to **ON** can suppress the color noise so as to get the clear and high-quality image in the low luminance environment.



The Chroma Suppress function is supported by certain camera model series.

● **Saturation**

Saturation indicates the brightness of the color. The higher the saturation, the brighter the color is.





The saturation function is supported by certain camera model series.

- **Contrast**

Contrast is the degree of difference between the darker and lighter parts of the image.



The contrast function is supported by certain camera model series.

- **HLC**

Set the **HLC** to **ON** can brighten the darker area and weaken the highlight area of the image.



The HLC function is supported by certain camera model series.

- **HR Mode**

Set the **HR MODE** as **ON** to adjust the resolution higher. Switch it **OFF** to disable the function, which can avoid cross color of the image.

### 3.3.2 Configuring Privacy Mask

**Purpose:**

Privacy mask enables you to cover certain areas on the live video from being live viewed and recorded. The masked areas can move with the panning/tilting movements and automatically adjust the size as the lens zooming in/out.

**Steps:**

1. Move the cursor to enter the privacy mask configuration submenu:

**MAIN MENUS > DOME SETTINGS > PRIVACYS**

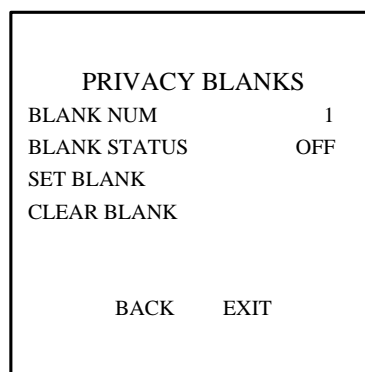

Figure 3-9 Privacy Mask Configuration Menu

2. Choose the privacy mask number:

**Steps:**

- (1) Move the cursor to **BLANK NUM** and click **IRIS+** to enter the editing mode.
- (2) Click the up and down direction buttons to select a mask number for configuration.
- (3) Click **IRIS+** again to confirm and exit the editing mode.



The configurable privacy mask number varies according to the camera models.

- Configure the position and size of the privacy mask.

**Steps:**

- Move the cursor to **SET BLANK** and click **IRIS+** button to enter the editing mode as shown in the following figure. You can see a privacy mask on the live window.

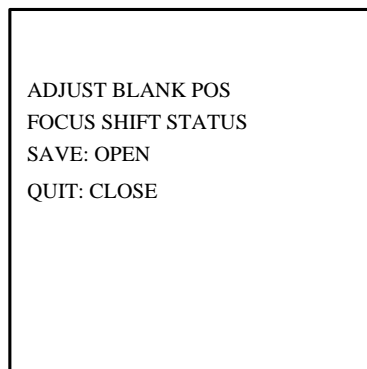

Figure 3-10 Set the Privacy Mask

- You can see *ADJUST BLANK POS* message on the screen. Click the direction buttons to adjust the position of the privacy mask to the designed scene.
- Click **FOCUS+** button, and you can see *ADJUST BLANK SIZE* message on the screen. Click the up/down buttons to increase/decrease the height of the mask and click right/left buttons to increase/decrease the width of the mask. Click **IRIS+** button to save the settings and return to the previous menu and you can see the mask turn to gray.
- To modify the configured mask, click **IRIS+** button to enter the **SET BLANK** menu and click **IRIS+** button again to modify.



The tilt range for configuring the privacy masks is from 0° to 70°.

- Enable or disable the privacy mask function.

Move the cursor to **BLANK STATUS**. Click **IRIS+** button to enter the editing mode and click the up and down direction buttons to set it **ON** or **OFF**.



If no privacy mask has been configured, you cannot set the status as **ON**.

- Delete the privacy mask.

You can enter the **DELE BLANK** menu to delete the current privacy mask.

## 3.4 Configuring PTZ Control Parameters

**Purpose:**

You can configure panning, tilting and zooming movements, and configure PTZ control functions

including presets, patrols, patterns, etc. for the speed dome.

### 3.4.1 Configuring PTZ Parameters

Enter PTZ configuration menu:

**MAIN MENU > DOME SETTINGS > MOTION PARAMETER**

MOTION		MOTION	
AUTO FLIP	ON	PRESET SPEED	4
PROPORTIONAL PAN	ON	LIMIT STOP	OFF
PARK TIME	5	SETTING STOPS	
PARK ACT	NONE	CLEAR STOPS	
SCAN SPEED	28	ELEVATION SET	ON
IMAGE FREEZE	OFF		
DOME SPEED	6		
BACK	EXIT	BACK	EXIT

Figure 3-11 PTZ Configuration

#### ● Auto-flip

In manual tracking mode, when a target object goes directly beneath the speed dome, the speed dome automatically rotates 180 degrees horizontally for tracking.



**AUTO-FLIP** is set as **ON** for this speed dome by default and it's not user-definable.

#### ● Proportional Panning

When the speed dome is zooming in/out, you can enable the proportional panning function to automatically reduce or increase the panning and tilting speed according to the zooming amount. This function enables the speed dome to trace the object at a proper speed when the speed dome is zooming and the monitored scene is narrowed (zoom in) or enlarged (zoom out).

You can set **PROPORTIONAL PAN** as **ON** or **OFF** to enable/disable the function.



This function is enabled automatically while setting the patterns.

#### ● Park time and actions

##### **Purpose:**

This feature allows the speed dome to start a predefined action (park action: scan, preset, pattern, etc.) automatically after a period of inactivity (park time).

You can set **PARK TIME** from 5 to 720 seconds and set the park action (**PARK ACT**) as preset 1-8, pattern 1-4, patrol 1-8, pan scan, tilt scan, random scan, frame scan, panoramic scan, day mode, night mode or none.



If no control signal is received after the park time under the following circumstances, no park actions will be performed: in the process of performing dome actions by calling special presets; or in the process of performing external alarm linkage actions.

### ● Image freeze

This feature enables the live view to switch directly from the current scene to another scene that is defined by a preset, without showing the middle areas between these two scenes. It reduces the use of bandwidth in a digital network system and it also provides privacy protection for the middle areas.

You can set **IMAGE FREEZE** as **ON** or **OFF** to enable or disable this function.



The function varies according to the different camera models.

### ● PTZ speed

#### **Purpose:**

You can define the speed of the dome movements.

- (1) **DOME SPEED:** The manual movement speed of the dome can be set from level 1 to 10.
- (2) **SCAN SPEED:** The scan speed defines the scan degree per second of pan scan, tilt scan, frame scan, random scan and panoramic scan. The scan speed is adjustable from level 1 to level 40 and the higher the level is, the faster the scan speed is.
- (3) **PRESET SPEED:** The speed of calling a preset can be set from level 1 to 8. The higher level corresponds to the faster speed to call a preset.

### ● Limit stops

#### **Purpose:**

The limit stops are user-configurable stops which limit the panning and tilting area of the speed dome. There are left, right, up and down limit stops to define an area.

#### **Steps:**

1. Move the cursor to **LIMIT STOPS** and click **FOCUS+** to set it **ON** to enable this feature. Click **IRIS+** to confirm the new settings.
2. Move the cursor to **SETTING LIMIT STOPS** and click **IRIS+**. You will see the message *SET LEFT LIMIT* on the screen.
3. Click the direction buttons in the PTZ panel to configure the left limit stop. Click **IRIS+** to confirm the new settings.
4. Follow the prompts to configure the right, up and down limit stops on the menu.



The new limit stops will overwrite the existed ones by default.

5. You can clear the defined limit stops. Click **IRIS+** to enter **CLEAR STOPS** and click **IRIS+** again to clear the stops.

### ● Elevation set

You can set **ELEVATION SET** as **ON** to increase the elevation angle range of the speed dome or set it as **OFF** to disable the function.



The range of the elevation angle is 0-90° by default and it changes to -2°-90° when the **ELEVATION SET** is set as **ON**.

## 3.4.2 Configuring Presets

### **Purpose:**

A preset is a user-defined monitoring position/point. You can simply call the preset number to change the monitor scene to the defined position.

### **Steps:**

1. Move the cursor to enter preset configuration submenu:

**MAIN MENU > DOME SETTINGS > PRESETS**

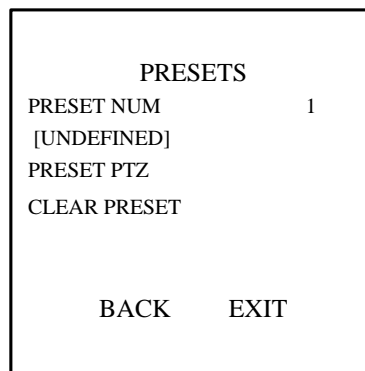

Figure 3-12 Preset Configuration Menu

2. Choose the preset number:

Move the cursor to **PRESET NUM** and click **IRIS+** to enter. Click the up and down buttons to choose the preset number which needs to be edited. If the preset has been defined, the preset label will be listed under the number; if it has not been defined, you will see the information **UNDEFINED** under the number.



- There are up to 255 presets can be set for the speed dome.
  - The system-defined presets will be displayed on this submenu and they are not editable.
3. Set the preset position.  
Move the cursor to **PRESET PTZ** and click **IRIS+** to edit the preset position. Use the direction buttons to move the speed dome to find the desired scene/position, and then press **IRIS+** to confirm the settings and return to the previous menu, or press **IRIS-** to cancel.



The preset position settings will be restricted by the limit stops if they are defined.

4. Call the presets.

You can select the preset number from the drop-down preset list in the control panel of the encoder through a web browser, and click the arrow to call a user-defined or system-defined preset.

5. Clear the preset settings.

Move the cursor to **CLEAR PRESET** and click **IRIS+** to clear the settings of the current preset.

### 3.4.3 Configuring Patrols

**Purpose:**

A patrol is a scanning track specified by a group of user-defined presets. You can call a patrol to scan the scenes automatically among the user-defined presets in sequence.

**Steps:**

1. Move the cursor to enter patrol configuration submenu:

**MAIN MENU > DOME SETTINGS > PATROLS**

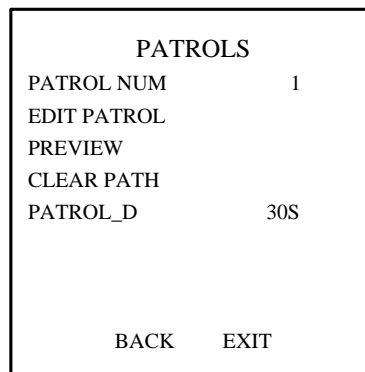

Figure 3-13 Patrol Configuration Menu

2. Choose the patrol number.

**Steps:**

(1) Move the cursor to **PATROLS NUM** and click **IRIS+** to enter edit mode.

(2) Click the up and down direction buttons to select the number of the patrol which is to be configured.

(3) Click **IRIS+** again to confirm the settings and exit edit mode of this column.



Up to 8 patrols can be configured.

3. Edit the patrol.

**Steps:**

(1) Move the cursor to **EDIT PATROL** and click **IRIS+** to enter edit mode.

NUM	PRESET	DWELL	SPEED
1	0	6	30
2	0	6	30
3	0	6	30
4	0	6	30
5	0	6	30
6	0	6	30
7	0	6	30
DONE: OPEN		QUIT:CLOSE	

Figure 3-14 Edit the Patrol

- (2) Click up/down direction buttons to choose the number and locate the preset to be edited.
- (3) Click left/right direction buttons to position the cursor to the column of **PRESET**, **DWELL** and **SPEED**. You can click the up/down direction buttons to set the value of preset number, dwell time and patrol speed.



The presets you set for a patrol should be the ones that have been pre-defined by users. The dwell time (0-30 seconds selectable) is the time that the speed dome stays on a certain preset; the patrol speed (level 1-40 selectable) is the scanning speed the speed dome switching between the presets.

- (4) Follow the above steps to define the other presets for the selected patrol. You can configure up to 32 presets in sequence for a patrol. Press **IRIS+** to save the new settings or press **IRIS-** to cancel and return to the previous menu.
4. Preview the patrol.  
Move the cursor to **PREVIEW** and click **IRIS+** to preview the current patrol. You can click **IRIS+** again to stop the preview.
5. Call the defined patrol.  
You can call the special presets to call the defined patrol. E.g. call preset 35 to call patrol 1. Please refer to *Section 2.3* to find the corresponding preset number for each patrol.
6. Delete a patrol.  
You can move the cursor to **CLEAR PATH** and click **IRIS+** to delete the current patrol.
7. Define the dwell time when running the fast patrol.  
If you call the No.46 preset to enable the fast patrol, the speed dome will run the patrol automatically according to the route consists of the configured preset 1 to preset 32. And you can set the Patrol\_D time switches from one preset to the other. 5S, 10S, 20S, 30S, and 60S are selectable.

### 3.4.4 Configuring Patterns

#### **Purpose:**

A pattern is a memorized, repeatable series of pan, tilt, zoom and preset movements that can be recalled by a command or automatically performed by a configured function (alarm, park, time task,

and power-up).

**Steps:**

1. Move the cursor to enter the **PATTERNS** submenu:

**MAIN MENU > DOME SETTINGS > PATTERNS**

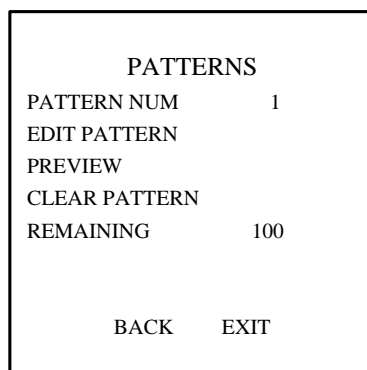

Figure 3-15 Pattern Configuration Menu

2. Choose the pattern number.

**Steps:**

- (1) Move the cursor to **PATTERN NUM** and click **IRIS+** to enter edit mode.
- (2) Click the up/down direction buttons to select the number of the pattern which is to be configured.
- (3) Click **IRIS+** again to confirm the settings.



Up to 4 patterns can be configured.

3. Edit the pattern.

**Steps:**

- (1) Move the cursor to **EDIT PATTERN** and click **IRIS+** to enter edit mode.

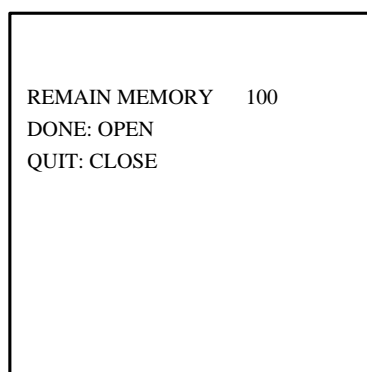

Figure 3-16 Edit the Pattern

- (2) Click the PTZ control buttons and direction buttons to operate the speed dome to draw a movement path, including pan scan, tilt scan, zoom in, zoom out, etc. The speed dome can automatically memorize the path you operated as a pattern.
- (3) Click **IRIS+** again to save the pattern and exit edit mode.





- **REMAIN MEMORY** indicates the remaining memory of the speed dome for configuring the patterns. When it reaches 0, no more patterns can be configured. You can also see the remaining memory shown under **PATTERNS** menu as *REMAINING*.
  - The pan/tilt movements and the lens operations cannot be memorized simultaneously.
4. Preview the pattern.  
Enter the **PREVIEW** menu to preview the current pattern.
  5. Call the defined pattern.  
You can call the special presets to call the defined pattern. E.g. call preset 41 to call pattern 1. Please refer to *Section 2.2* to find the corresponding preset number for each pattern.
  6. Delete the patterns.  
To Delete a Chosen Pattern  
Click **IRIS+** to enter **EIDT PATTERN** and you can see *DEL PATH ABOVE*. Click **IRIS+** to delete the pattern.



If you delete the current pattern, the following pattern will also be deleted. E.g., if pattern 2 is deleted, pattern 3 and pattern 4 will be deleted as well.

To Clear All the Patterns

Enter **CLEAR PATTERN** menu and click **IRIS+** to delete all the defined patterns.

### 3.4.5 Configuring Time Tasks

**Purpose:**

A time task is a preconfigured action that can be performed automatically at a specific date and time.

**Steps:**

1. Move the cursor to enter the **TIME TASK** submenu:  
**MAIN MENU > DOME SETTINGS > TIME TASK**

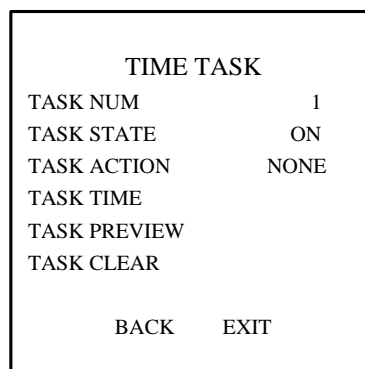

Figure 3-17 Time Task Configuration Menu

2. Choose the task number.

**Steps:**

- (1) Move the cursor to **TASK NUM** and click **IRIS+** to enter edit mode.
- (2) Click the up/down direction buttons to select the number of the task which is to be configured.
- (3) Click **IRIS+** again to confirm the settings and exit the edit mode.



Up to 8 time tasks can be configured.

3. Set the task status.

**Steps:**

- (1) Move the cursor to **TASK STATE** and click **IRIS+** to enter edit mode.
- (2) Click the up/down direction buttons to set the task status to **ON**.
- (3) Click **IRIS+** again to confirm the settings and exit edit mode of this column.



If the task action and task time have not been configured, you cannot set the status as **ON**.

4. Configure the task action.

**Steps:**

- (1) Move the cursor to **TASK ACTION** and click the **IRIS+** to enter edit mode.
- (2) Click the up and down direction buttons to select the task action from preset 1-8, pattern 1-4, patrol 1-8, pan scan, tilt scan, random scan, frame scan, panoramic scan, day mode, night mode, zero calibrate and none.
- (3) Click **IRIS+** again to confirm the settings and exit edit mode of this column.

5. Set the task time.

**Steps:**

- (1) Move the cursor to **TASK TIME** and click **IRIS+** to enter edit mode.
- (2) Click the left and right direction buttons to position the cursor to **WEEK, START (H-M)** and **END (H-M)**.
- (3) Click the up and down direction buttons to set the start time and end time to run the time task.
- (4) Click **IRIS+** to confirm the settings and exit.



The weekday can be set to be from **Monday** to **Sunday** or **Whole Week**; the **H** refers to Hour and the **M** refers to Minute.

WEEK	WHOLE WEEK
START(H-M)	00 00
END(H-M)	00 00
DONE: OPEN	
QUIT: CLOSE	

Figure 3-18 Set the Task Time

## 6. Delete the task.

Move the cursor to **TASK CLEAR**, click **IRIS+** to delete the time and action of the current task, and click **IRIS+** again to confirm the settings and exit.

### 3.4.6 Configuring Zone

**Purpose:**

A zone is a panning and tilting area defined by the left/right and up/down limit stops. You can configure the zones on **ZONES** submenu. You can define a zone when the targeted surveillance scene is limited.

**Steps:**

## 1. Move the cursor to enter the zone configuration submenu:

**MAIN MENU > DOME SETTINGS > ZONES**

ZONES	
ZONE NUM	1
[UNDEFINED ]	
EDIT ZONE	
ZONE STATUS	ON
SCAN STATUS	ON
CLEAR ZONE	
BACK	EXIT

Figure 3-19 Zone Configuration

## 2. Choose the zone number:

- (1) Move the cursor to **ZONE NUM** and click **IRIS+** button to enter the edit mode.
- (2) Click the up and down buttons to select the zone number to be configured.
- (3) Click **IRIS+** again to confirm the settings and exit edit mode of this column.



Up to 8 zones can be configured.

## 3. Configure the zone area.

**Steps:**

- (1) Move the cursor to **EDIT ZONE** and click **IRIS+** button to enter the edit mode.
  - (2) You can see *SET LEFT LIMIT* on the screen. Click the direction buttons to set the left limit stop.
  - (3) Follow the prompts on the screen to set the right limit, up limit and down limit.
  - (4) Click **IRIS+** button to save the settings and exit.
4. Set the zone status and scan status.

**ZONE STATUS:** The zone status just indicates the current status of the zone.

**SCAN STATUS:** You can set the scan status to **ON/OFF** to enable/disable the scanning in the zone.



**ZONE STATUS** is not editable. After you edited the zone, it will switch to **ON** automatically; if you delete the zone, the **ZONE STATUS** will switch to **OFF**.

5. Clear the zone settings.

Move the cursor to **CLEAR ZONE**, click **IRIS+** to clear all the settings of the current zone, and click **IRIS+** again to confirm the settings and exit.

### 3.4.7 Clearing PTZ Control Settings

**Purpose:**

You can clear all user-defined PTZ control settings, including presets, patrols, patterns, zones and time tasks. You can also clear privacy masks on this menu.

**Steps:**

1. Enter the **CLEAR SETTINGS** menu:

**MAIN MENU > DOME SETTINGS > CLEAR SETTINGS**

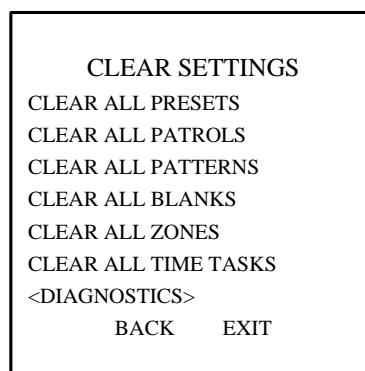

Figure 3-20 Clear Dome Settings

2. Move the cursor to each item, e.g., **CLEAR ALL PATTERNS**, and click **IRIS+** to enter the corresponding submenu. Click **IRIS+** again to confirm the settings and exit.  
On **DIAGNOSTICS** submenu, you can see the self-diagnostics information of the speed dome. For more details, please refer to the table below.

DIAGNOSTICS		DIAGNOSTICS	
HIGH TEMP	0	PAN LOST	0
HIGHEST TEMP	47 °C	TILT LOST	0
LOW TEMP	0	CAMERA LOST	0
LOWEST TEMP	23 °C		
VIDEO LOSS	0		
LOW VOLTAGE	0		
POWER UP	0		
BACK	EXIT	BACK	EXIT

Figure 3-21 Self-diagnostics

Table 1-3 Descriptions of self-diagnostics information

Item	Description
HIGH TEMP	The occurrence times of high temperature (higher than 65°C)
HIGHEST TEMP	The highest temperature
LOW TEMP	The occurrence times of low temperature (lower than -25°C)
LOWEST TEMP	The lowest temperature
VIDEO LOSS	The occurrence times of video loss
LOW VOLTAGE	The occurrence times of low voltage (lower than the working voltage)
POWER UP	The occurrence times of abnormal reboot
PAN LOST	The occurrence times of panning loss
TILT LOST	The occurrence times of tilting loss
CAMERA LOST	The occurrence times of communication loss



The panning loss and tilting loss refer to the failures of panning and tilting movement, and are for diagnosing the electric motor of the speed dome.

## 3.5 Others

### 3.5.1 Configuring Dome Authentication

#### **Purpose:**

You can modify the password and enable/disable the password protection to prevent unauthorized settings of the speed dome. After you set and enable the password, you need to input the password every time you call preset 95 to enter the menu.

#### **Steps:**

1. Move the cursor to enter the password modification submenu:

**MAIN MENU > DOME SETTINGS > PASSWORD > EDIT PASSWORD**

2. Click **IRIS+** to enter edit mode.
3. Click the left/right buttons to select the digit of the current password and click up/down or **FOCUS+/-** buttons to set the new value.
4. Click the right direction button to move the cursor to **INPUT PW AGAIN** and input the password again.
5. Click **IRIS+** to save the new settings and exit.
6. Enter the **START USING** submenu and switch the status to **ON** and click **IRIS+** to save.

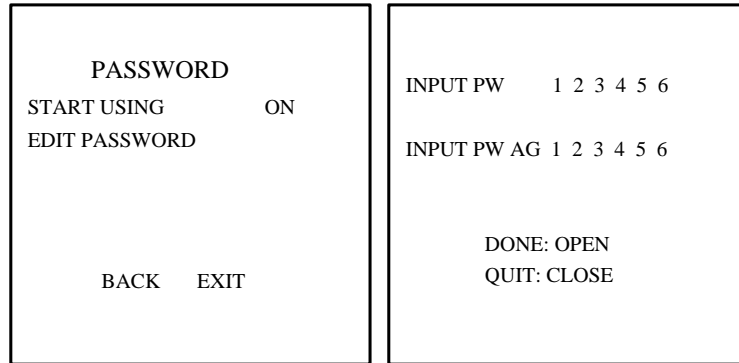

Figure 1-2 Set the Password

**3.5.2 Restoring Default Dome Settings****Purpose:**

You can reset all dome settings to factory default parameters as shown in the table below.



Dome settings are mainly of PTZ parameters and alarm parameters, and also include some system settings, e.g. dome address.

Enter default dome settings menu:

**MAIN MENUS > RESTORE DEFAULTS**

Click **IRIS+** to restore the dome settings to the default value shown as the following table, or click **IRIS-** to exit.

Table 1-4 Default Dome Settings

Parameters	Default Value
Dome address	0
Baud rate	2400bps
120Ω matching resistance	Off
Soft address	Off
Focus	HAF
Zoom limit	Max Optical Zoom
Zoom speed	High

Parameters	Default Value
Slow shutter	Off
IR cut filter	Day
D/N level	Mid
BLC	Off
AE mode	Auto
Exposure compensation	7
White balance	Auto
Auto-flip	On
Proportional pan	On
Park time	5 seconds
Park act	None
Scan speed	28
Image freeze	Off
Limit stops	Off
Time show	Off
Zone show	On
Address show	Off
Error rate show	Off
Zoom/PT/Preset show	Off

### 3.5.3 Restoring Default Camera Settings

Enter **MAIN MENU > RESTORE CAMERA**

Click **IRIS+** to restore the camera settings to the default value; or click **IRIS-** to exit.



Camera settings include the image parameters, lens settings and display settings.

### 3.5.4 Rebooting the Dome

Enter **MAIN MENU > REBOOT DOME** and click **IRIS+** to reboot the speed dome remotely.

# Appendix

## Appendix 1 Lightning & Surge Protection

This product adopts TVS plate lightning protection technology to avoid damage caused by pulse signal that is below 3000W, like instantaneous lighting stroke, surging, etc. According to the actual outdoor situation, necessary protection measures must be taken, besides ensuring the electrical safety.

- The distance between signal transmission wires and High-voltage equipment or high-voltage cable is at least 50m.
- Outdoor wiring should better be routed under eaves as much as possible.
- In the open field, wiring should be buried underground in sealed steel pipe, and the steel-pipe should be one-point grounding. Overhead routing method is forbidden.
- In strong thunderstorm area or high induction voltage areas (such as high-voltage transformer substation), high power lightning protection apparatus and lightning conductor are necessary to be added.
- The design of lightning protection and grounding of the outdoor devices and cables should be considered together with the lightning protection demand of buildings. It also must conform to the related national standards and industrial standards.
- The system should be equipotential grounded. The grounding equipment must conform to the demands of system anti-jamming and electrical safety both and it must not appear short circuit or mixed circuit with the zero conductor of strong grid. When the system is grounded alone, the resistance should be no more than  $4\Omega$ . The sectional area of the grounding cable should be no less than  $25\text{mm}^2$ . For grounding instructions, please refer to the Installation Manual of Speed Dome.

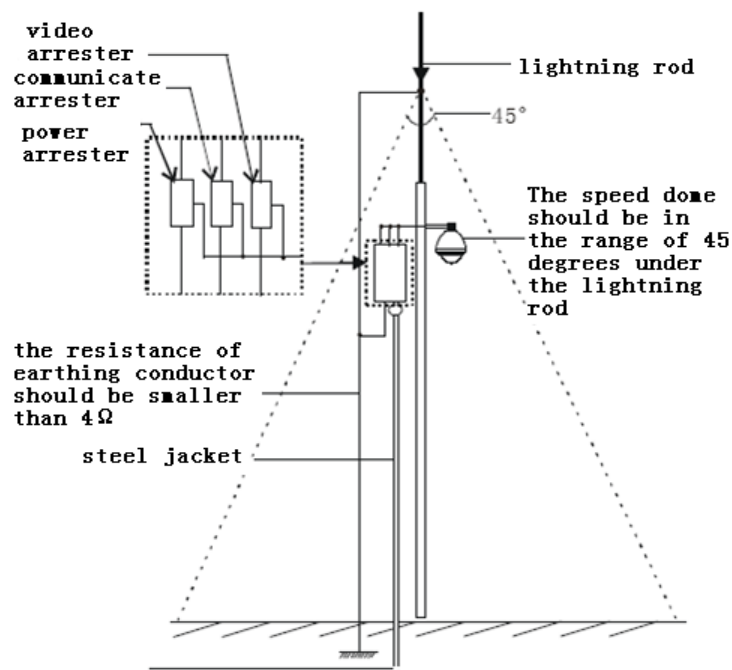

Figure A- 1 Lightning & Surge Protection



## Appendix 2 RS485 Bus Connection

### ● General Property of RS485 Bus

According to RS485 industry bus standard, RS485 is a half-duplex communication bus which has  $120\Omega$  characteristic impedance, the maximum load ability is 32 payloads (including controller device and controlled device).

### ● RS485 Bus Transmission Distance

When using 0.56mm (24AWG) twisted-pair line, according to different baudrate, the maximum transmission distance theory table is shown as below:

Table A-1 Max. Distance of RS485 Transmission

Baudrate	Max Distance
2400BPS	1800m
4800BPS	1200m
9600BPS	800m

The transmission distance will be decreased if we use the thinner cable, or use this product under the strong electromagnetic interference situation, or there are lots of devices are added to the bus; on the contrary, the transmission distance will be increased.

### ● Connection Methods

RS485 industry bus standard require daisy-chain connection method between any devices, both sides have to connect a  $120\Omega$  terminal resistance (show as Diagram 1), the simplified connection method is shown as diagram 2, but the distance of "D" should not be too long.

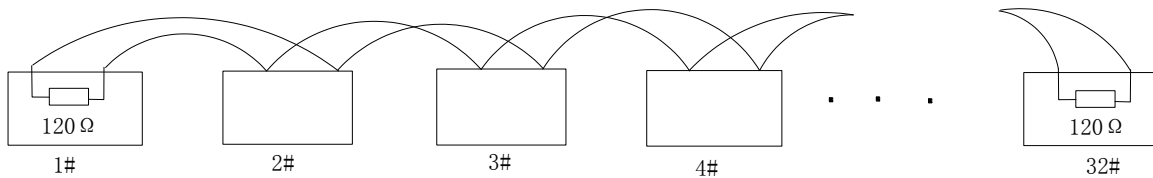

Figure A-2 RS485 Connection 1

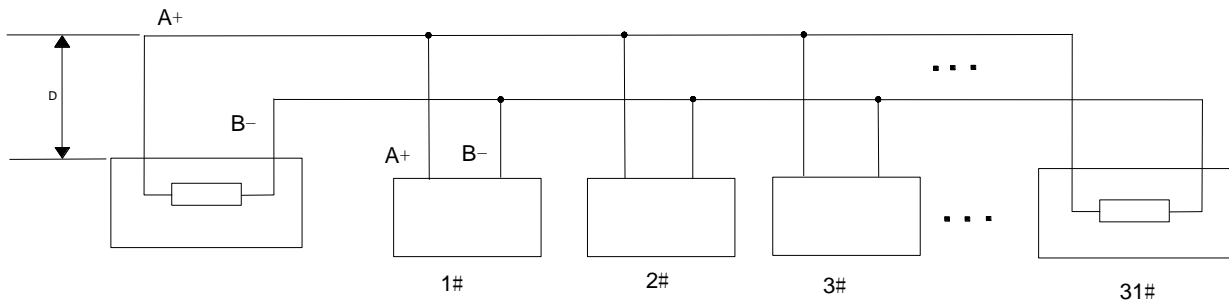

Figure A-3 RS485 Connection 2

### ● Problems in the Practical Application

Normally, users adopt star-shape connection method in construction, under this situation, the terminal resistors must be connected between two farthest devices (as Figure 4, 1# and 15#), but this connection method is not satisfy the requirement of the RS485 industry standard so that it will lead to some problems such as signal reflection, anti-jamming ability decline when the devices are

faraway. At this time, the dome will be uncontrollable, or self-running, etc.

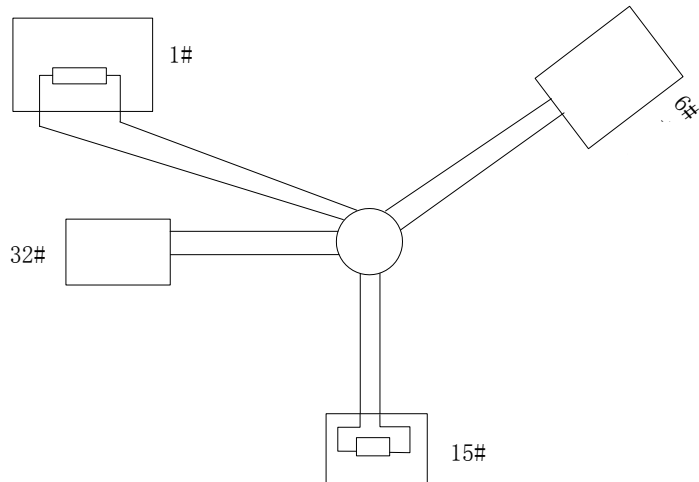

Figure A-4 Star Shape Connection

For such case, the best way is adding a RS485 distributor. This product can effectively change the star-shape connection to which satisfies the requirement of RS485 industry standard, in order to avoid those problems and improve the communication reliability. Show as figure 5.

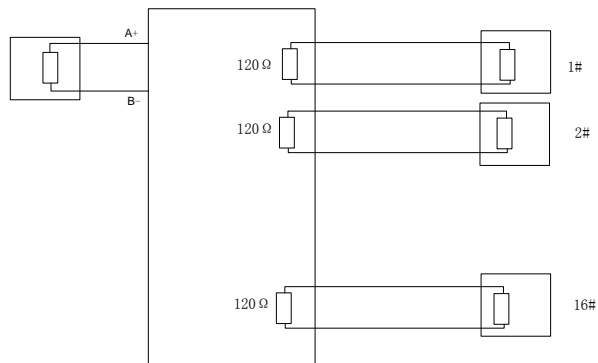

Figure A-5 RS485 Distributor

● Troubleshooting of RS485 communication

Problem	Possible Reasons	To Solve the Problem
The speed dome does the self-test action but cannot be controlled remotely.	1. The address or baudrate of the speed dome does not match with those of remote control device.	1. Adjust the address and baudrate of the remote control device to match with those of the speed dome.
	2. The wire RS485+ connects to the interface RS485- and wire RS485- connects to the interface RS485+.	2. Connect the wire RS485+ to the interface RS485+ and wire RS485- to the interface RS485-.
	3. The RS485 wire is disconnected.	3. Reconnect the RS485 wire tightly.
	4. RS485 wire is broken.	4. Change a RS485 wire.
The speed	1. The connection is loose.	1. Reconnect the RS485 wire

<b>Problem</b>	<b>Possible Reasons</b>	<b>To Solve the Problem</b>
dome can be controlled but not smoothly.		tightly.
	2. RS485+ or RS485-wire is broken.	2. Change a RS485 wire.
	3. The speed dome is too far away from the remote control device.	3. Add a terminal resistor.
	4. Too many speed domes are connected.	4. Add a RS485 distributor.

## Appendix 3 24VAC Wire Gauge & Transmission Distance

The following table describes the recommended max. distance adopted for the certain wire gauge when the loss rate of 24VAC voltage is less than 10%. For the AC driven device, the maximum voltage loss rate is 10% allowable. For example, for a device with the rating power of 80VA which is installed at a distance of 35 feet (10m) away from the transformer, then 0.8000mm is required as the minimum wire gauge.

	0.8000	1.000	1.250	2.000
10	283 (86)	451 (137)	716 (218)	1811 (551)
20	141 (42)	225 (68)	358 (109)	905 (275)
30	94 (28)	150 (45)	238 (72)	603 (183)
40	70 (21)	112 (34)	179 (54)	452 (137)
50	56 (17)	90 (27)	143 (43)	362 (110)
60	47 (14)	75 (22)	119 (36)	301 (91)
70	40 (12)	64 (19)	102 (31)	258 (78)
80	35 (10)	56 (17)	89 (27)	226 (68)
90	31 (9)	50 (15)	79 (24)	201 (61)
100	28 (8)	45 (13)	71 (21)	181 (55)
110	25 (7)	41 (12)	65 (19)	164 (49)
120	23 (7)	37 (11)	59 (17)	150 (45)
130	21 (6)	34 (10)	55 (16)	139 (42)
140	20 (6)	32 (9)	51 (15)	129 (39)
150	18 (5)	30 (9)	47 (14)	120 (36)
160	17 (5)	28 (8)	44 (13)	113 (34)
170	16 (4)	26 (7)	42 (12)	106 (32)
180	15 (4)	25 (7)	39 (11)	100 (30)
190	14 (4)	23 (7)	37 (11)	95 (28)
200	14 (4)	22 (6)	35 (10)	90 (27)

## Appendix 4 Table of Wire Gauge Standards

Bare Wire Gauge(mm)	American Wire Gauge AWG	British Wire Gauge SWG	Cross-sectional Area of Bare Wire(mm <sup>2</sup> )
0.750	21		0.4417
0.800	20	21	0.5027
0.900	19	20	0.6362
1.000	18	19	0.7854
1.250	16	18	1.2266
1.500	15	17	1.7663
2.000	12	14	3.1420
2.500			4.9080
3.000			7.0683



First Choice for Security Professionals