

CD-Recorder User's Guide

CDR56S-6XX	6X24
CDR58S-XXX	8X24
CDR56S-4XX	4X24

CD-Recorders

TEAC

ADDENDUM

This addendum provides additional information, which covers the TEAC 4x24 CD-R drive kits. The kits are shipped with either internal or external model.

Internal 4x24 CD-R Kit

The internal CD-Recorder kit includes the following items:

- TEAC internal (4x24) SCSI CD-Recordable drive
- CD-ROM containing pre-mastering and recording software, including:
 - Adaptec Direct CD drag & drop software (version 2.5c or higher)
 - Adaptec Easy CD Creator premastering software (version 3.5b or higher)
 - Adaptec CD Copier Deluxe
- One blank TEAC CD-R disc
- Interface cable (ribbon cable)
- Audio cable (internal to PC)
- Mounting screws
- TEAC CD-Recorder User's Guide
(SCSI adapter card not included)

External 4x24 CD-R Kit for PC

The external CD-Recorder kit includes the following items:

- TEAC external (4x24) SCSI CD-Recordable drive
- PCI bus master SCSI host adapter card (controller)
- CD-ROM containing pre-mastering and recording software, including:
 - Adaptec Direct CD drag & drop software (version 2.5c or higher)
 - Adaptec Easy CD Creator premastering software (version 3.5b or higher)
 - Adaptec CD Copier Deluxe
- One blank TEAC CD-R disc
- Interface cable
- Power cable
- SCSI terminator resistor
- TEAC CD-Recorder User's Guide

Chapter 2. SCSI Host Adapter Card (page 11)

The SCSI adapter card is not included with the internal 4x24 kit. However, you must install a SCSI adapter card in the host computer before you can connect and operate your TEAC CD-Recorder. For optimum performance of your CD-Recorder, a PCI bus master SCSI adapter card (such as an Adaptec 2940 or equivalent) is recommended. Please refer to the adapter card documentation for installation instruction.

Chapter 5. Installing Software (page 25)

The main installation panel for Direct CD higher than version 2.5a and Easy CD Creator higher than version 3.5a will look different than those shown on pages 27 and 30.

Appendix B. Specifications (page 39)

The TEAC 4x24 CD-Recorder has the same specifications as the 6x24 listed on this manual. Please refer to pages 39 and 40 for the internal or external model respectively.

Macintosh Users – Read This First

Addendum to the TEAC CD-R User's Guide

Information

This addendum provides additional information for installing the TEAC external 8x24 CD-R drive on G3 or Power Macintosh systems.

Package Includes:

The external CD-Recorder kit includes the following items:

- TEAC External 8x24 SCSI CD-Recordable drive
- PCI bus master SCSI host adapter card (controller)
- CD-ROM containing pre-mastering and recording software, including:
 - Adaptec Toast pre-mastering software (version 3.5.7 or higher) for Macintosh
 - Adaptec Direct CD drag & drop software (version 2.5c or higher) for Windows
 - Adaptec Easy CD Creator pre-mastering software (version 3.5b or higher) for Windows
 - Adaptec CD Copier Deluxe software for Windows
- One blank TEAC CD-R disc
- External SCSI Interface cable
- Power cable
- SCSI terminator resistor
- TEAC CD-Recorder User's Guide

Macintosh System Requirements

- 68040 or Power Macintosh™ or G3 or newer
- Mac OS™ 7.5.1 or later
- 8MB of RAM (24MB recommended)
- 8MB of available hard disk space
- An available PCI bus slot on G3 system

Installation

Installing the Adaptec 2903B SCSI Host Adapter Card

You must first install the SCSI card on a G3 system before you can connect and operate your TEAC CD-Recorder. Other Macintosh systems, which come equipped with an Apple SCSI connector, will not require this step. Refer to Chapter 2, page 11 and Chapter 4, page 19 of the User's Guide for details on installing the card and configuring your external 8x24 CD-Recorder.

Installing the SCSI card Driver Software (for G3 system)

1. Insert the Adaptec Software CD-ROM disc into your computer's CD-ROM drive. AutoPlay will open a pop-up window.
2. Locate the SCSI Card Installation folder and double-click on it to start the SCSI card installation.
3. Double-click on the *Adaptec AVA-2903B Installer* file and follow the menu-driven installation program to complete this installation. The CD-Recorder will mount ONLY after the Toast software has been installed. For additional information and instructions, consult with the Readme First file included on the same CD-ROM disc.

Installing the Toast Pre-mastering Software

1. Insert the Adaptec SCSI Card Driver and Toast CD-ROM disc into your computer's CD-ROM drive. AutoPlay will open a pop-up window with folders for different languages.
2. Locate the language folder of your choice (i.e. English) and double-click on it to start the software installation.
3. Double-click on the *Adaptec Toast 3.5.7 Installer* file and follow the menu-driven installation program to complete the installation. For additional information and instructions, consult with the Readme Toast 3.5.7 and Toast User Manual 3.5.pdf files included on the same CD-ROM disc.

Technical Notes

1. The System Profiler will detect the 2903B card type as "NOT AVAILABLE" and the card name as the "PCI 9004, 7850". This is a normal detection process.
2. Direct AUDIO/MUSIC copy from the CD-ROM drive to TEAC CD-Recorder is not supported by Toast 3.5.7.

Technical Support

For technical assistance, please call one of the TEAC technical support numbers listed on the User's Guide or send E-mail to dsptsg@teac.com.

Safety Precautions

TEAC CD-Recorders are high-precision electronic devices. Do not use them in any manner other than as specified in this manual. Please read this manual in its entirety before you begin the installation procedure. Use of controls, adjustments, or performance of procedures other than those specified herein may result in hazardous radiation exposure.

To prevent fire or shock, do not expose the unit to moisture or rain.

To prevent electrical shock, do not open the cabinet of an external CD-Recorder or disassemble an internal CD-Recorder. Refer servicing to authorized personnel.

The CD-Recorder utilizes a laser beam that can be harmful to the eyes. Do not disassemble the cabinet or unit. Do not attempt to look through the front panel or into the unit while the power is turned on.

A user who changes or modifies the unit or operating procedures specified herein without express written approval by the manufacturer will void user authority to operate the equipment.

Specifications and features subject to change without notice or obligation.

Compliance Information Statement

These devices, trade name CD-Recordable External SCSI Subsystem, model numbers CD-Recorder 8X24 and 6X24, comply with Part 15 of the FCC Rules. Operation is subject to the following two conditions: (1) such device may not cause harmful interference, and (2) such device must accept any interference received, including interference that may cause undesired operation.

The parties responsible for device compliance are:

TEAC Corporation
857 Koyata, Iruma-Shi
Saitama-Ken 358-8510
Japan
81 (429) 62-7158

TEAC America, Inc.
7733 Telegraph Road
Montebello, CA 90640
USA
(323) 726-0303

FCC Radio Frequency Interference Regulations

Warning: This equipment generates, uses, and can radiate radio frequency energy and if not installed and used in accordance with the instructions contained in this manual, may cause harmful interference to radio and television communications. This equipment has been tested and found to comply with the limits for a Class B digital device pursuant to Subpart J of Part 15 of the FCC Rules. These limits are designed to provide reasonable protection against harmful interference in a residential installation. However, there is no guarantee that interference will not occur in a particular installation. To ensure compliance with FCC rules, the cable that connects the unit to the computer must be a shielded interface cable.

Note: Connecting this device to peripheral devices that do not comply with Class B requirements or using an unshielded peripheral cable could result in interference to radio or television reception. To ensure that the use of this product does not contribute to interference, use a shielded interface cable.

If this equipment does cause harmful interference to radio or television reception (which can be determined by turning the equipment off and on), the user may try to correct the interference by one of more of the following measures:

- Reorient or relocate the receiving antenna
- Move the device and the receiver further apart
- Connect the equipment to an electrical outlet on a circuit different from that of the receiver
- Consult the dealer or an experienced audio television technician

Also, the following booklet may prove helpful: *How to Identify and Resolve Radio-TV Interference Problems*. It is available from the U.S. Government Printing Office, Washington, D.C. 20402, stock number 004-000-00345-4.

The user is cautioned that any changes or modifications not expressly approved by TEAC America, Inc. could void the user's warranty.

Copyright and Trademark Information

This manual is copyright © 1998 by TEAC America Inc.
TEAC is a trademark of TEAC Corporation.
IBM PC/AT are registered trademarks of International Business Machines Corporation.
Adobe and Acrobat are trademarks of Adobe Systems, Inc.
Adaptec is a trademark of Adaptec, Inc.
All other trademarks and registered trademarks are the property of their respective owners.

© Copyright 1998 TEAC America Inc. All rights reserved. TEAC America Inc. reserves the right to modify product offerings or specifications without advance notice. No part of this publication may be produced in any format without the express written permission of TEAC America Inc.

Table of Contents

Safety Precautions	i
Compliance Information Statement	i
FCC Radio Frequency Interference Regulations	ii
Copyright and Trademark Information	ii
Table of Contents	iii
Chapter 1. Introduction	1
Recommended System Requirements	2
About this Guide.	3
CD-Recorder Package Contents	4
Internal CD-Recorder Kit	4
External CD-Recorder Kit	5
Front Panel	6
Rear Panel of the Internal CD-Recorder	8
Rear Panel of the External CD-Recorder	9
Chapter 2. SCSI Host Adapter Card	11
Installing a SCSI Host Adapter Card	11
Chapter 3. Configuring and Installing an Internal CD-Recorder	13
Configuring the Internal CD-Recorder.	13
Setting the SCSI ID Number on the Internal CD-Recorder	13
Terminating the Internal CD-Recorder	14
Configuring Other Jumpers on the CD-Recorder.	15
Setting the Parity Switch	15
Logical Block Size	15
Test Mode	15
Drive Orientation	15
Installing the CD-Recorder in a Computer.	16
Chapter 4. Configuring and Connecting an External CD-Recorder	19
Configuring the External CD-Recorder	19
Setting the SCSI ID Number on the External CD-Recorder	19
Terminating the CD-Recorder	20
Drive Orientation	21
Connecting the External CD-Recorder.	22

Chapter 5. Installing Software	25
Installing Direct CD and Easy CD Creator	26
About the User Guides for Direct CD and Easy CD Creator	31
Starting Direct CD	32
Using Direct CD	32
Starting Easy CD Creator	33
Using Easy CD Creator	33
Installing Other Programs	34
Uninstalling Programs	35
Appendix A. About CD-R Discs	37
Handling Discs	37
Recommended Media	37
Disc Formats	37
Loading and Ejecting Discs	38
Appendix B. Specifications	39
Internal CD-Recorder model	39
External CD-Recorder models	40
Appendix C. Technical Support	41

Chapter 1. Introduction

Thank you for purchasing a TEAC CD-Recorder kit.

TEAC CD-Recorders comprise two internal and two external models. Depending on the model, the CD-Recorder can write to CD-R discs at a maximum of 8X and 6X speeds. (Each unit is also capable of operating at slower speeds, if preferred.)

All models can read CD-ROM discs at 24X speed.

Please refer to "Appendix B. Specifications" on page 39 for detailed specifications for each model number.

The appearance, installation and operation of all internally-mounted CD-Recorders is identical. Similarly, the appearance, installation and operation of all external CD-Recorders is also identical.

For convenience, this manual refers to "internal" or "external" TEAC CD-Recorders. The referenced information applies to all internal or external models.

The TEAC internal CD-Recorder is designed for use in IBM PC or compatible computers. It is available in a 6 x 24 model and features a 5.25-inch standard chassis and a powered tray for convenient disc loading.

TEAC external CD-Recorders are designed for use as external peripherals for IBM PC or compatible computers. They are available in 8 x 24 and 6 x 24 models. They feature a rugged external case and a powered disc tray.

You may also use external CD-Recorders with an Apple Macintosh computer. However, you will need to purchase separate Macintosh-compatible pre-mastering or recording software, which is not included in this kit. Consult your dealer or Macintosh documentation for more information.

Recommended System Requirements

- IBM PC-compatible computer, Pentium 133MHz or higher
- 16MB of RAM
- A hard drive that meets or exceeds the following minimum specifications:
 - 1GB hard disk space (or more)
 - 1.2MB/second data transfer rate (or faster)
 - 12ms average access time (or less)
- Sufficient hard disk space for software installation (see the documentation for the recording software)
- Windows 95/98 or Windows NT
- An available PCI bus slot in the host computer (for the included adapter card)

About this Guide

This user's guide explains how to install and operate the TEAC internal and external CD-Recorders.

This guide is divided into the following main sections:

Chapter 1. Introduction: This chapter introduces the CD-Recorders and describes shipping package contents and recommended system requirements.

Chapter 2. Installing a SCSI Host Adapter Card: This chapter explains how to install a SCSI host adapter card in your computer to interface with the TEAC CD-Recorder.

Chapter 3. Configuring, Connecting, and Installing an Internal CD-Recorder: This chapter explains how to configure an internally-mounted CD-Recorder, including setting the SCSI ID, termination, and other jumper settings. It also explains how to install the CD-Recorder in your computer.

Chapter 4. Configuring and Connecting an External CD-Recorder: This chapter explains how to configure an external CD-Recorder, including setting the SCSI ID and termination. It also explains how to connect the CD-Recorder to your computer.

Chapter 5. Installing the Recording Software: This chapter explains how to install the pre-mastering and other software included on the *TEAC CDR Software Suite* CD-ROM.

Appendix A. About CD-R Discs: This appendix contains information about media, formats, and loading and ejecting discs.

Appendix B. Specifications: This appendix provides technical specifications for TEAC CD-Recorders.

Appendix C. Technical Support: This appendix provides technical support listings for TEAC in North America, Europe, Australia, and Asia.

CD-Recorder Package Contents

TEAC CD-Recorders are shipped in kits that contain components appropriate for either the internal or external model. The following sections illustrate and describe the components of each kit.

Internal CD-Recorder Kit

The internal CD-Recorder kit includes the following items:

- TEAC CD-Recorder internal (6x24) SCSI CD-Recordable Drive
- PCI bus master SCSI host adapter card (controller)
- CD-ROM containing pre-mastering and recording software, including:
 - Adaptec Direct CD drag & drop software
 - Adaptec Easy CD Creator premastering software
 - MGI PhotoSuite SE software
 - CD Catalog software
- One blank TEAC CD-R disc
- Interface cable (ribbon cable)
- Audio cable (internal to PC)
- Mounting screws (not shown)
- TEAC CD-Recorder User's Guide* (this manual)

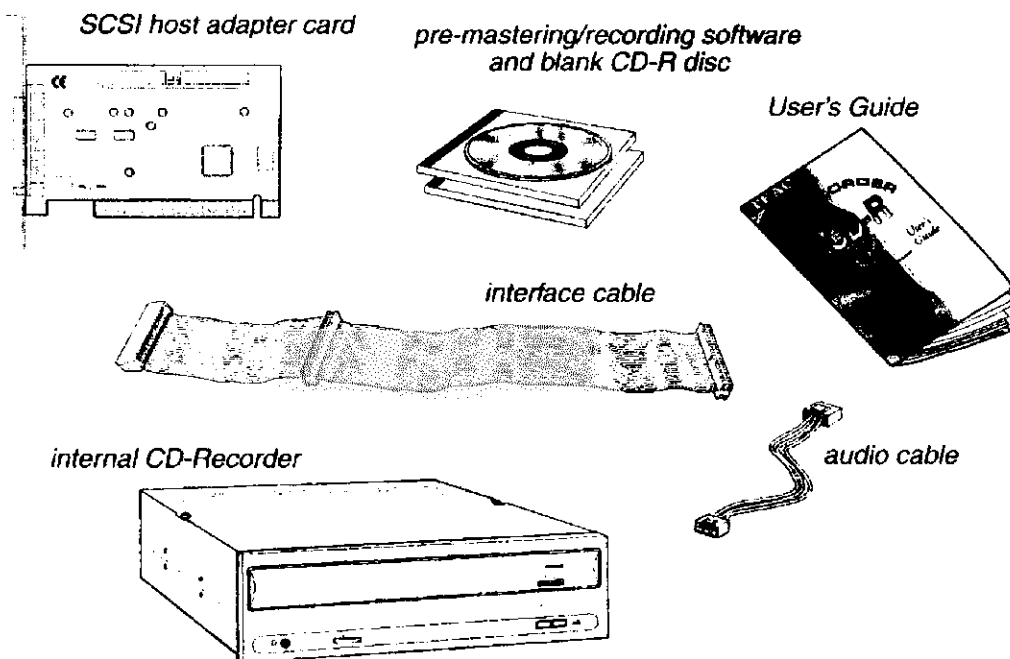

Figure 1. Internal CD-Recorder Kit Package Contents

External CD-Recorder Kit

The external CD-Recorder kit includes the following items:

- TEAC CD-Recorder external (6x24 or 8x24) SCSI CD-Recordable Drive
- PCI bus master SCSI host adapter card (controller)
- CD-ROM containing pre-mastering/recording software, including:
 - Adaptec Direct CD drag & drop software
 - Adaptec Easy CD Creator premastering software
 - MGI PhotoSuite SE software
 - CD Catalog software
- One blank TEAC CD-R disc
- Interface cable
- Power cable
- SCSI terminator resistor
- TEAC CD-Recorder User's Guide* (this manual)

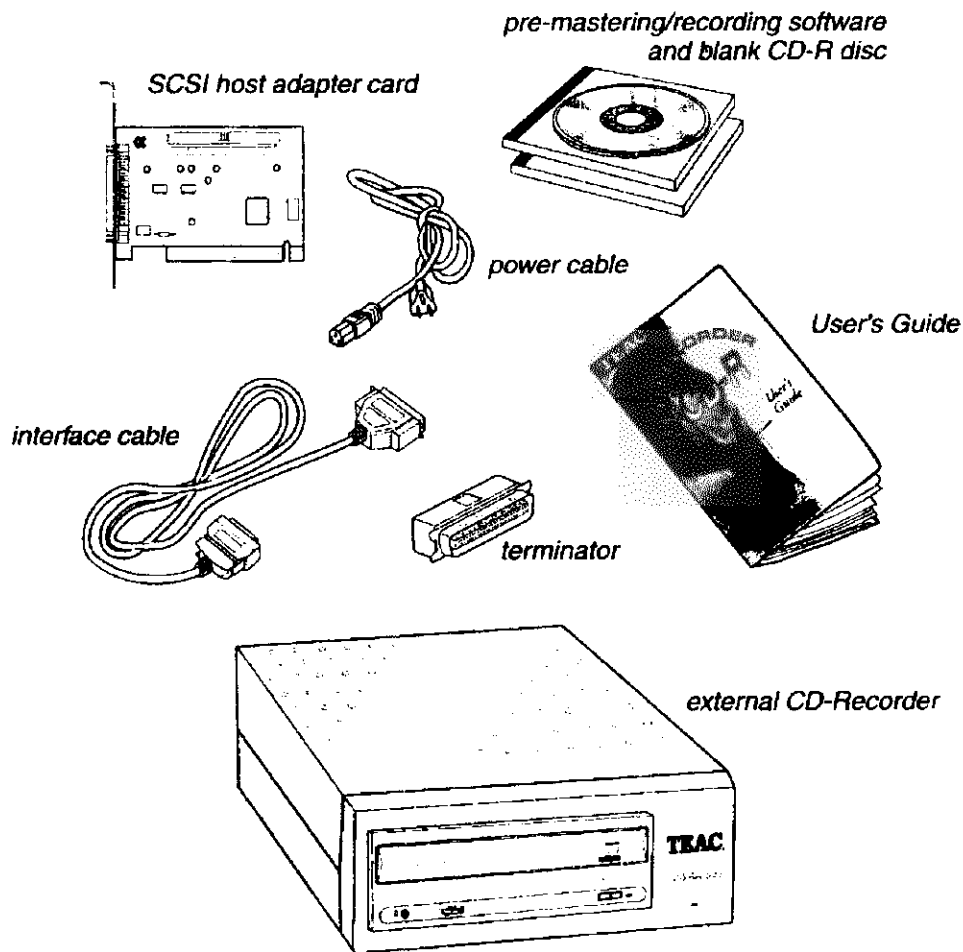

Figure 2. External CD-Recorder Kit Package Contents

Front Panel

Figure 3 illustrates the front panel of the internal CD-Recorder.

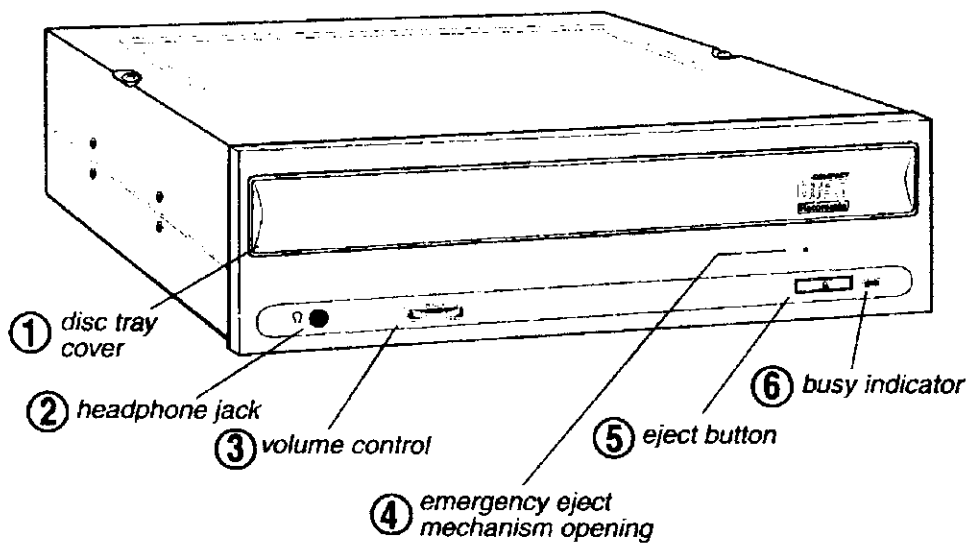

Figure 3. Front Panel of Internal CD-Recorder

Figure 4 illustrates the front panel of the external CD-Recorder.

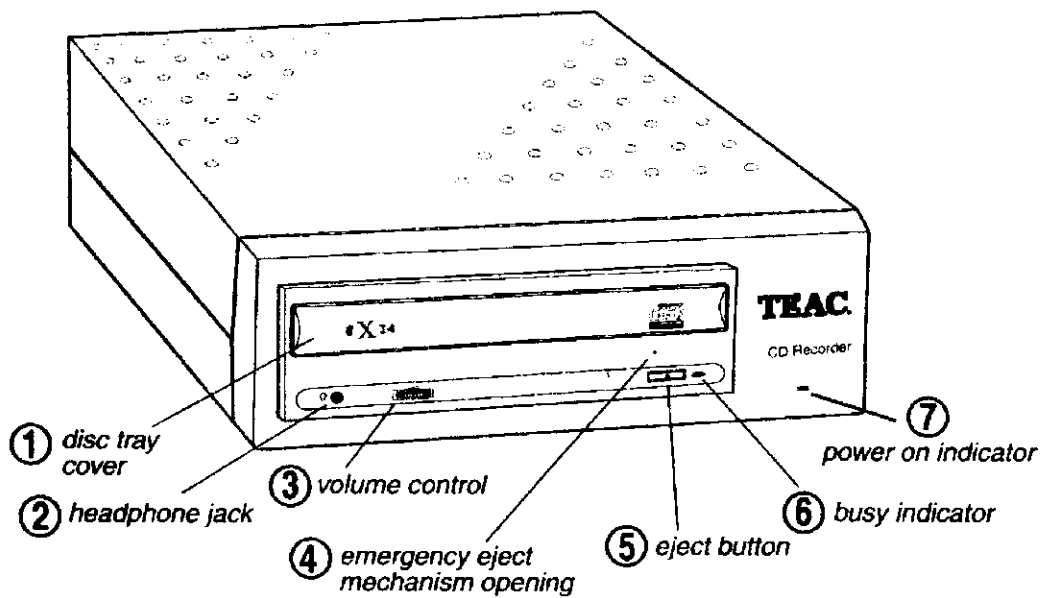

Figure 4. Front Panel of the External CD-Recorder

- ① **disc tray cover:** The disc tray cover prevents dust from entering the drive chassis. It opens and closes in an interlocked motion with the disc tray during loading and unloading.

Caution: Do not use your fingers to open or close the disc tray cover or you may damage the unit or cause it to fail.

- ② **headphone jack:** You can connect headphones or external speakers to this jack. Use a 3.5 mm stereo mini-plug. For external speakers, connect a stereo adapter to split the output into separate cables for the left and right channels. Such adapters convert a male stereo mini-jack to two female phono jacks.
- ③ **volume control:** Use the volume control to adjust the volume. Turning the control to the right increases the volume. (Lower the volume before you start a CD-ROM program to protect your hearing and the audio speakers.)
- ④ **emergency eject mechanism:** If the eject button fails, *when the power is turned off* you can insert a small, thin rod (such as a straightened paper clip) into the emergency eject mechanism opening and press firmly to eject the disc.

Caution: Do not attempt to use the emergency eject mechanism when either the Power or On/Busy indicator is lit or you may seriously damage the CD-ROM disc or the CD-Recorder.

- ⑤ **eject button:** Press this button to open or close the disc tray. (Some CD-ROM titles disable the manual eject button and rely on software commands to eject the disc. Refer to the documentation for these titles.)
- ⑥ **busy indicator:** The Busy indicator LED indicates whether the drive is powered off, seeking, reading, or writing data as per the following table:

Indicator Status	Meaning
Continuously lit	Seeking data or busy
Flashing at intervals of 0.8 seconds	Drive powering up or error detected
Flashing at intervals of 1.6 seconds	Audio being played
Flashing at intervals of 3.2 seconds	Recording data
Off	Not seeking data, not busy

- ⑦ **power-on indicator:** The power-on indicator LED indicates that the CD-Recorder (external CD-Recorders only) is powered on.

Rear Panel of the Internal CD-Recorder

Figure 5 illustrates the rear panel of the internal CD-Recorder.

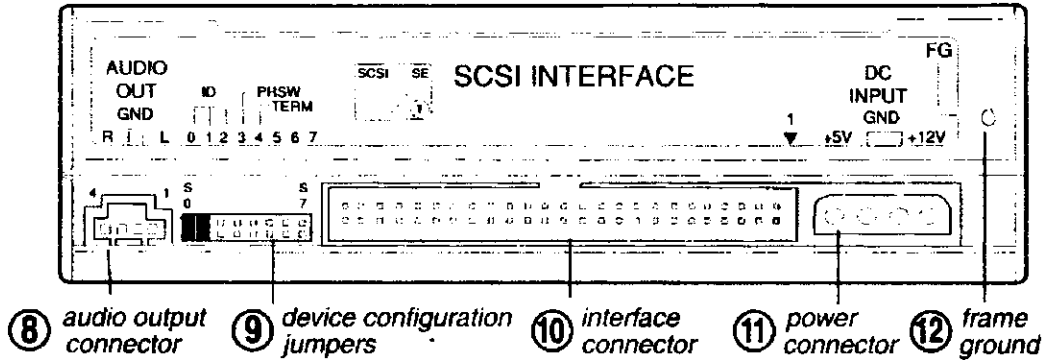

Figure 5. Rear Panel of the Internal CD-Recorder

- 8 audio output connector:** Connect this connector to the audio input connector on a sound card. Pin assignments are described in the following table:

Pin Number	Audio Signal
1	Left signal
2	Ground
3	Ground
4	Right signal

- 9 device configuration jumpers:** The internal CD-Recorder features a block of eight (S0 - S7) pairs of jumper pins. These jumpers allow you to set the SCSI ID number, enable or disable termination, set the parity check, set the logical block size, or place the drive in test mode.

S0, S1, S2	Set SCSI ID number
S3	Parity check
S4	Enable or disable termination
S5	Reserve
S6	Logical block size
S7	Test mode

- 10 interface connector:** Use a 50-pin interface cable (ribbon cable) to connect the interface connector to a SCSI adapter card.
- 11 power connector:** Connect the power connector to the +5VDC and +12VDC power sources. The +5VDC terminal is on the left as you face the rear panel; the +12VDC terminal is on the right. The two center terminals are ground terminals.
- 12 FG:** Frame ground. This is a ground connection for the internal CD-Recorder.

Rear Panel of the External CD-Recorder

Figure 6 illustrates the rear panel of the external CD-Recorder.

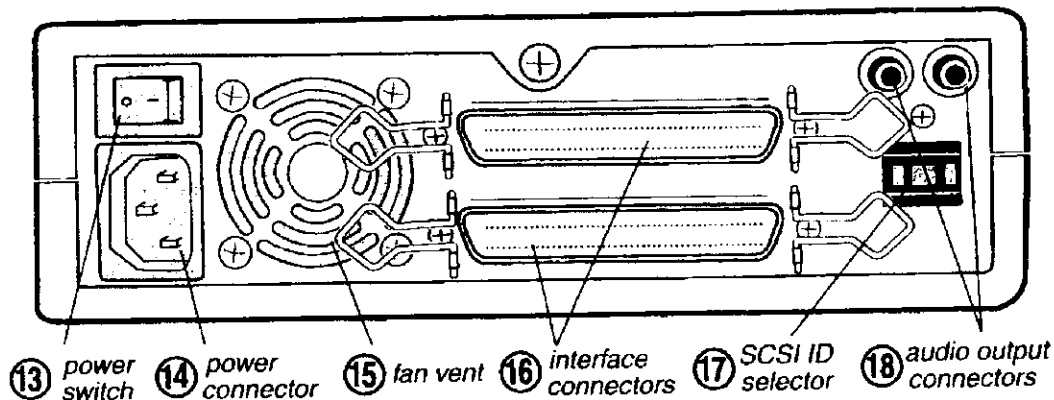

Figure 6. Rear Panel of the External CD-Recorder

- ⑬ **power switch:** Press this rocker switch to turn the power to the external CD-Recorder on or off.
- ⑭ **power connector:** Connect the power connector to an electrical AC outlet using the included power cable.
- ⑮ **fan vent:** These openings vent the cooling fan. Be careful not to block the airflow from these vents.
- ⑯ **interface connectors (2):** Connect one of these interface connectors to your computer. Use the included interface cable to connect the external CD-Recorder to the SCSI host adapter card that is included in this kit (after you install the host adapter card in your computer). (See "Connecting the External CD-Recorder" on page 22.)
- ⑰ **SCSI ID number selector:** Use a pen or pencil tip to press the buttons on either side of the selector mechanism to set the SCSI ID number for the external CD-Recorder. (See "Setting the SCSI ID Number on the External CD-Recorder" on page 19.)
- ⑱ **audio output connectors (L and R):** Connect these left and right phono jacks to the audio input connectors on a sound card using an RCA-type phono audio cable. (The sound card must be connected to external speakers.) The red jack is the left channel; the white jack is the right channel.

Chapter 2. SCSI Host Adapter Card

You must install a SCSI adapter card in the host computer before you can connect and operate your TEAC CD-Recorder.

TEAC has included a SCSI adapter card in the package. This card is a PCI bus mastering controller, a state-of-the-art, PCI format, 32-bit, Plug-and-Play controller (Figure 7).

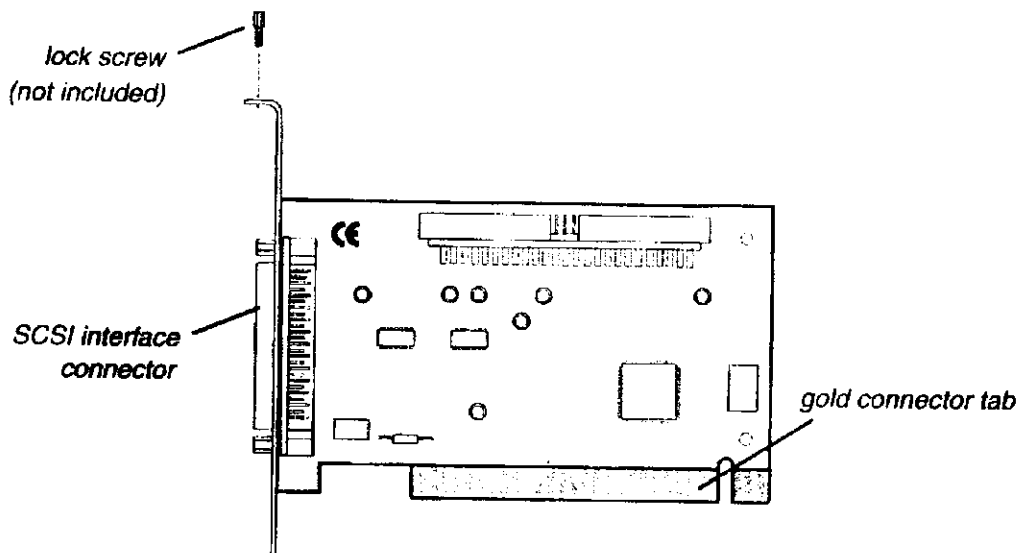

Figure 7. SCSI Host Adapter Card

Installing a SCSI Host Adapter Card

The following procedure explains how to install a SCSI adapter card in your host computer.

1. **Make sure your computer is turned off.**
2. **Remove your computer's cover.**

Refer to the documentation that came with your computer for more information.

3. **Wear an anti-static wrist strap or ground yourself by touching the power supply housing in your computer.**

Electro-static discharge can seriously damage your computer or the host adapter card. (The computer's AC power cable must be connected to a grounded AC outlet for this technique to be effective.)

4. **Remove the slot cover for the expansion slot in which you plan to install the host adapter card.**

(You will probably need to remove a lock screw in order to remove the slot cover.)

- 5. Align the gold connector tab on the host adapter card with the PCI expansion slot, and gently guide the card into position.**

Make sure it is securely seated in the connector. (Refer to Figure 8.)

- 6. Replace the lock screw.**
- 7. Do one of the following:**

If you are installing an external CD-Recorder, reassemble your computer, then proceed to “Chapter 4. Configuring and Connecting an External CD-Recorder” on page 19.

If you are installing an internal CD-Recorder, proceed to “Chapter 3. Configuring and Installing an Internal CD-Recorder” on page 13.

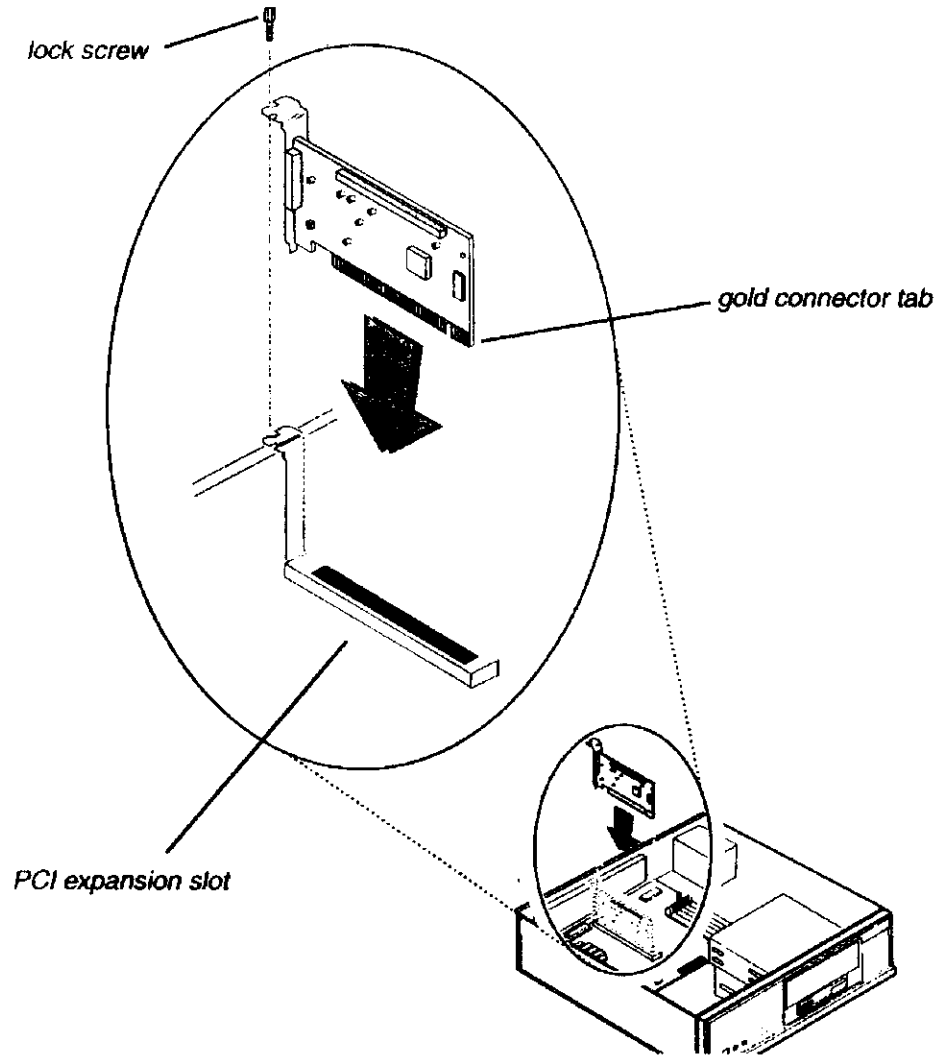

Figure 8. Installing the SCSI Host Adapter Card

Chapter 3. Configuring and Installing an Internal CD-Recorder

This chapter explains how to configure, terminate, and install an internally-mounted TEAC CD-Recorder in your computer.

Configuring the Internal CD-Recorder

Before you can install and operate your internal TEAC CD-Recorder, you need to configure it for use in a SCSI chain. To do this, you need to do two things:

- Set the SCSI ID number on the CD-Recorder
 - Terminate the CD-Recorder if it is located at the end of the SCSI chain.
-

Setting the SCSI ID Number on the Internal CD-Recorder

To set the SCSI ID number on the internal CD-Recorder, you must set jumpers on the back panel of the unit.

(You also use this jumper pin configuration block to configure the CD-Recorder for termination, logical block size, and parity settings. See “Configuring Other Jumpers on the CD-Recorder” on page 15 for more information.)

The following paragraphs explain how to configure an internal CD-Recorder by placing jumpers (short plugs) in various combinations on the jumper pin configuration block.

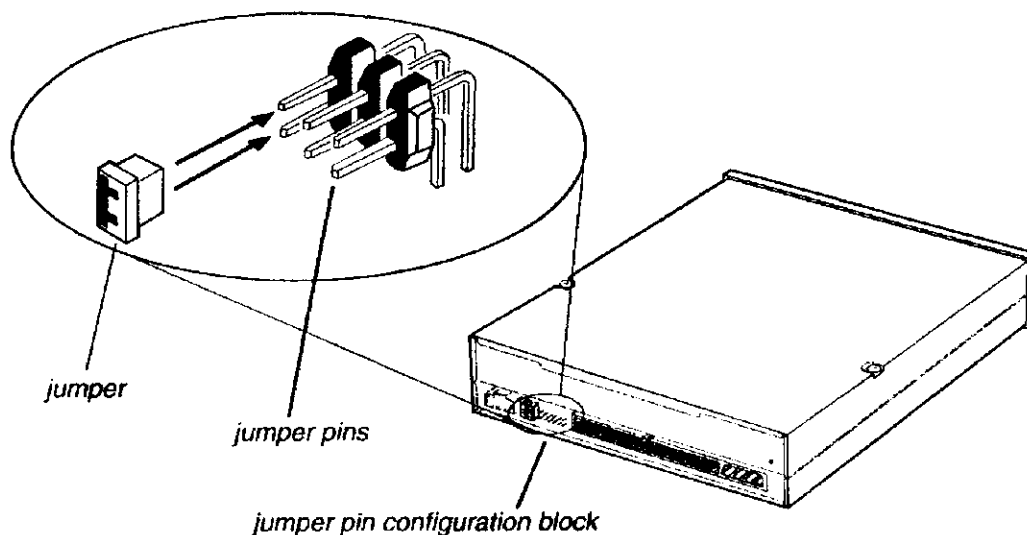

Figure 9. Jumper Pin Configuration Block on an Internal CD-Recorder

Terminating the Internal CD-Recorder

You set the SCSI ID number for the internal CD-Recorder by placing jumpers in various combinations on jumper pin pairs S0, S1, and S2. The following table indicates the appropriate pin combinations. "Close" indicates that you should place a jumper on the specified jumper pins. "Open" indicates that you should not place a jumper on the specified pins (leaving the connection "open").

For example, to set the CD-Recorder to SCSI ID 5, you would place jumpers on jumper pins S0 and S2.

The factory default setting is SCSI ID 3.

SCSI ID	S0	S1	S2
0	Open	Open	Open
1	Close	Open	Open
2	Open	Close	Open
3	Close	Close	Open
4	Open	Open	Close
5	Close	Open	Close
6	Open	Close	Close
7	Close	Close	Close

Terminating the Internal CD-Recorder

If you position the CD-Recorder at the end of a SCSI chain, you must "terminate" the CD-Recorder by removing a jumper at position S4 in the jumper pin configuration block on the rear panel of the CD-Recorder.

If jumper pin S4 is open (i.e., the jumper is not seated on both pins), the CD-Recorder is terminated. If S4 is closed (i.e., the jumper is seated on both pins), the CD-Recorder is not terminated.

The factory default setting for the CD-Recorder is open (terminated).

You must terminate the end of the SCSI bus; however, do not terminate the CD-Recorder if it is not located at the end of the SCSI bus.

Warning: Failure to correctly terminate the SCSI bus may result in malfunction to the CD-Recorder.

Configuring Other Jumpers on the CD-Recorder

The following paragraphs explain how to configure the jumper pin block on the rear panel of the CD-Recorder, including setting the parity switch, logical block size, and test mode.

Setting the Parity Switch

If jumper pin S3 is open, an odd parity check is performed for the input data. If S3 is closed, no parity check is performed. The factory default setting is open.

Logical Block Size

If jumper pin S6 is open, the drive will operate at 2,048 bytes per logical block. If S6 is closed, it will operate at 512 bytes per logical block. The number of bytes per logical block can be changed using Mode Select command. The factory default setting is open.

Test Mode

If jumper pin S7 is closed, the drive will enter test mode upon power up. This jumper pin is intended for TEAC factory use only. The factory default setting is open.

Drive Orientation

Install an internal CD-Recorder in your personal computer in a horizontal orientation (within $\pm 5^\circ$ of horizontal). The eject button should be located on the right side of the unit.

Installing the CD-Recorder in a Computer

After you configure the jumper pin block as explained on pages 13 and 14, you are ready to install the CD-Recorder in your computer.

The following procedure explains how to install the CD-Recorder into an IBM PC-compatible personal computer. Follow the steps below and refer to your computer documentation for information specific to your system.

(Note: If you just completed the procedure for installing a SCSI card as described on pages 11 and 12, you have already completed steps 1 through 4 below. If so, please verify these steps and proceed to step 5.)

- 1. Turn off the power to the computer and all devices connected to the SCSI bus.**
- 2. Configure the jumper pin block on the rear panel of the CD-Recorder.**
(For more information, refer to "Setting the SCSI ID Number on the Internal CD-Recorder" on page 13 and "Terminating the Internal CD-Recorder" on page 14.)
- 3. Remove your computer's cover, faceplate, or bay cover, as well as mounting clips, screws, and retaining bracket.**
Refer to your computer documentation for more information.
- 4. Determine the appropriate bus slot for the SCSI adapter card. Remove the mounting screw that holds the slot cover in place. Insert the card and secure it using the same screw.**
Refer to your computer documentation for more information.
- 5. Slide the CD-Recorder into the drive bay. Secure it using the included 3mm screws.**

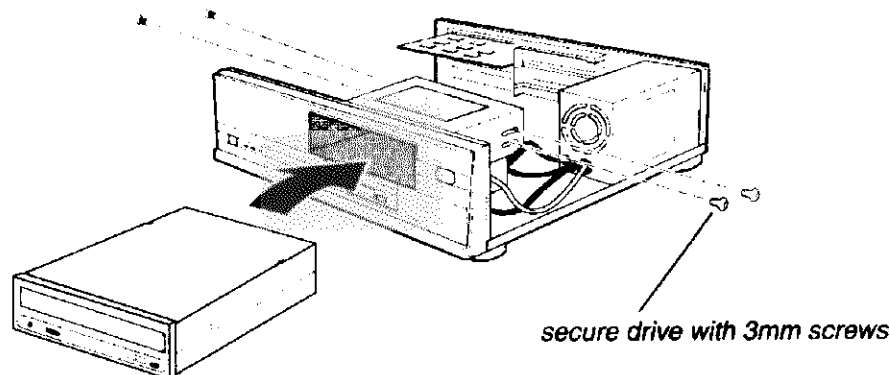

Figure 10. Installing an Internal CD-Recorder in a Computer

6. Connect the CD-Recorder to the SCSI host adapter card using the included 50-pin interface ribbon cable.

Be certain to connect pin 1 on the CD-Recorder to pin 1 on the SCSI adapter card. (Pin 1 on the interface cable is usually designated by a color stripe along one edge of the cable. Also, the interface ribbon cable connector may feature a tab on one side. Insert the cable so that the tab aligns with the notch in the interface connector. Refer to Figure 11.)

7. Connect the CD-Recorder to your sound card using the included audio cable, if desired.

Be certain to connect audio connector pin 1 on the CD-Recorder to pin 1 on the sound card. (Refer to Figure 11.)

8. Connect the power cable to the power connector on the rear panel of the CD-Recorder.

Be certain to insert the power cable plug in the correct orientation into the power connector. (The plug is shaped so that it can be easily inserted in only one orientation; do not force the plug into the connector.)

9. Re-install your computer's cover, faceplate, or bay cover.

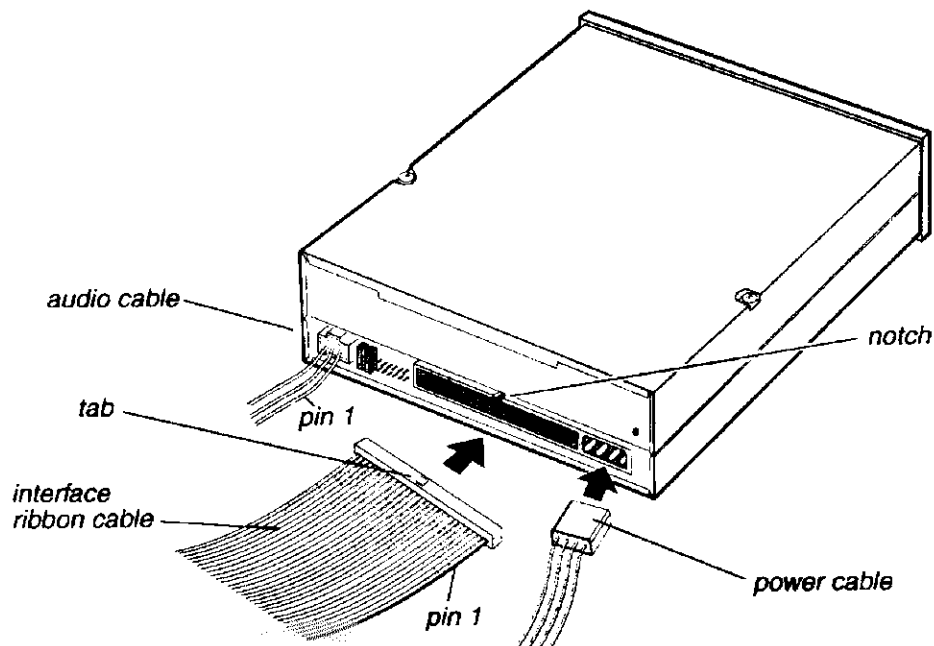

Figure 11. Connecting the Internal CD-Recorder

Chapter 4. Configuring and Connecting an External CD-Recorder

This chapter explains how to configure, terminate, and connect an external TEAC CD-Recorder to your computer.

Configuring the External CD-Recorder

Before you can install and operate the CD-Recorder, you need to configure it for use in a SCSI chain. To do this, you need to do two things:

- Set the SCSI ID number on the CD-Recorder.
- Terminate the CD-Recorder if it is located at the end of the SCSI chain.

Setting the SCSI ID Number on the External CD-Recorder

You can set the SCSI ID number for the external CD-Recorder by pressing either of two buttons on the SCSI ID mechanism on the rear panel of the unit. Use a pen or pencil tip to press the up or down button on the SCSI ID number mechanism to set the SCSI ID number (Figure 12).

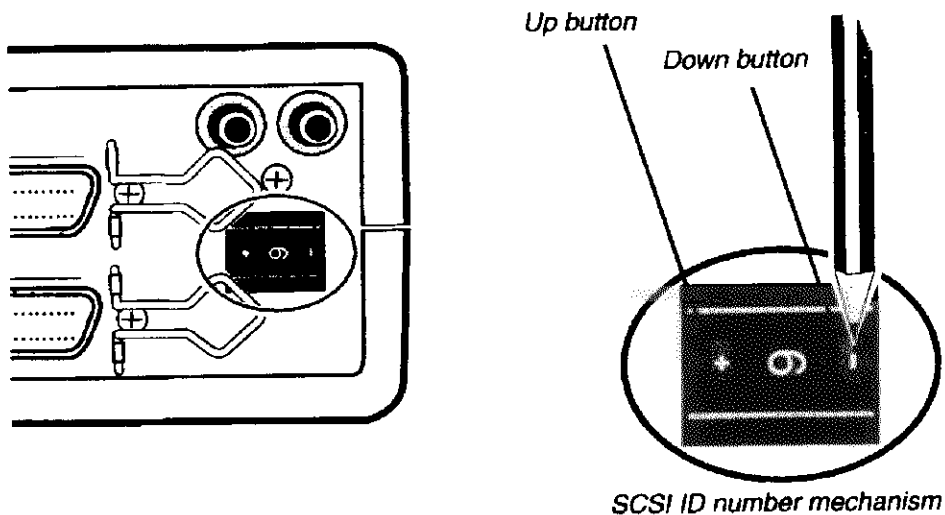

Figure 12. Setting the SCSI ID Number on the External CD-Recorder

You can set the CD-Recorder to SCSI ID numbers 0 through 6. The number 0 is generally reserved for the system.

Select a SCSI ID number that is unique within your host computer's SCSI device chain. The factory default setting is SCSI ID 6.

Terminating the CD-Recorder

If you position the CD-Recorder at the end of a SCSI chain, you must “terminate” the CD-Recorder by connecting a terminator resistor to either of the interface connectors on the rear panel of the CD-Recorder. A terminator resistor (Figure 13) is included in the external CD-Recorder kit.

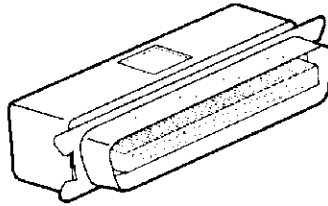

Figure 13. Terminator for External CD-Recorder

The external CD-Recorder includes two interface connectors on the rear panel. You can use either of these connectors to connect the drive to the computer.

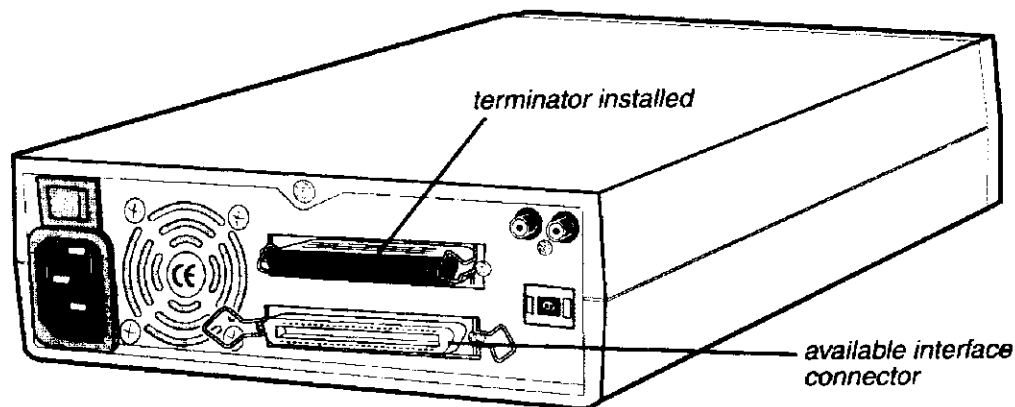

Figure 14. Terminator Installed on External CD-Recorder

If the external CD-Recorder is *not* located at the end of the SCSI device chain, you can use a SCSI-to-SCSI cable to connect additional drives or peripheral devices. In any event, the peripheral device at the end of the SCSI configuration chain must be terminated.

If the external CD-Recorder is located at the end of the SCSI chain, install the included terminator resistor on the available interface connector (i.e., the connector not used for the interface cable).

Warning: Failure to correctly terminate the SCSI bus may result in malfunction to the CD-Recorder.

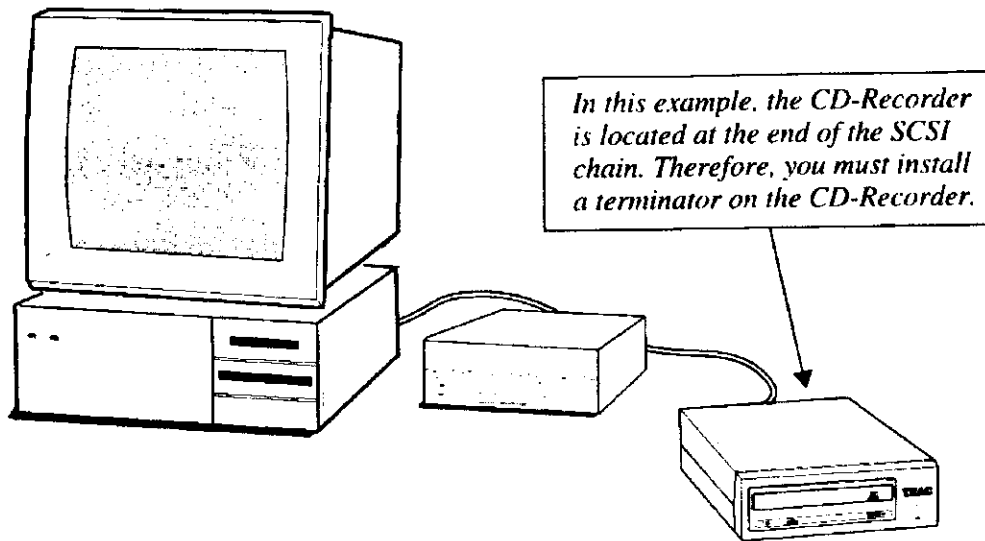

Figure 15. Example of a SCSI Chain of External Drives

Drive Orientation

The external CD-Recorder should be placed on a stable, horizontal surface. The TEAC logo should be located on the right side of the unit.

Connecting the External CD-Recorder

Connect the external CD-Recorder to an IBM PC-compatible personal computer. Follow the steps below and refer to your computer documentation for information specific to your system.

1. **Turn off the power to the computer and all devices connected to the SCSI bus.**
2. **Make sure you have already installed the SCSI host adapter card in your computer.**
(See "Chapter 2. SCSI Host Adapter Card" on page 11.)
3. **Make sure the SCSI ID number is correctly set on the CD-Recorder.**
(Refer to "Setting the SCSI ID Number on the External CD-Recorder" on page 19.)
4. **Locate the interface cable that was shipped with your CD-Recorder.**
5. **Connect the 50-pin Centronics SCSI connector on the interface cable to either of the two SCSI connectors on the rear panel of the CD-Recorder (Figure 16).**

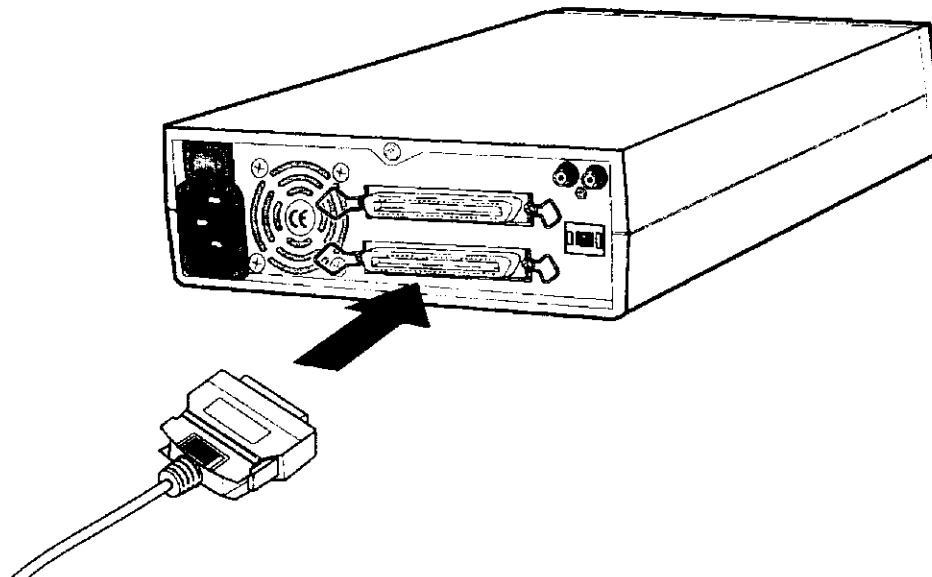

Figure 16. Connecting the Interface Cable to the External CD-Recorder

6. **Connect the other connector on the adapter cable to the connector on the back edge of the host adapter card that now protrudes from the rear panel of your computer's chassis (Figure 17).**

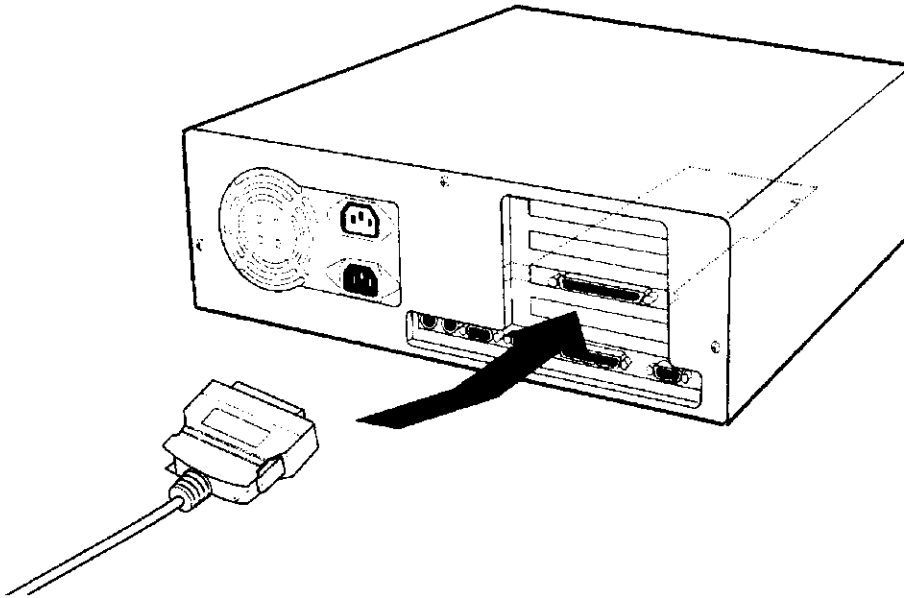

Figure 17. Connecting the Interface Cable to the Computer

7. **Connect the power cable to the power connector on the rear panel of the CD-Recorder.**

Be certain to insert the power cable plug in the correct orientation into the power connector. (The plug is shaped so that it can be easily inserted in only one orientation; do not force the plug into the connector.)

8. **Insert the other end of the power cable into an AC electrical outlet.**
9. **Turn on the power to the CD-Recorder (and any other peripheral devices on the SCSI chain). Then start up the computer.**

Your CD-Recorder should now work as a typical CD-ROM drive. Your computer's operating system should detect the CD-Recorder.

You are now prepared to install the CD recording software. Refer to "Chapter 5. Installing Software" on page 25.

Chapter 5. Installing Software

Before you can record data onto CD-R discs using your TEAC CD-Recorder, you must first install CD-R recording and premastering software onto your computer's hard disk.

TEAC CD-Recorder kits include a CD-ROM that contains the following pre-mastering and recording software applications for Windows 95/98 and Windows NT systems:

❑ **Adaptec Direct CD, Version 2.5a or higher**

Direct CD is a "drag & drop" software application that allows you to read and write to your CD-Recorder as if it were a standard floppy or removable hard drive. It also provides the tools necessary to format the media.

❑ **Adaptec Easy CD Creator, Version 3.5a or higher**

Easy CD Creator is a full-featured premastering software application.

An installation procedure for these two applications is provided below. In addition to the above programs, the CD-ROM also includes other applications that you may explore:

❑ **CD Catalog**

CD Catalog is an application that enables you to browse and order CD-ROM labels and other accessories.

❑ **PhotoSuite SE**

PhotoSuite SE is an image editing and photo archiving software application.

The CD-ROM also includes numerous images in the Photo_cd folder that you can view and edit using PhotoSuite SE.

Installing Direct CD and Easy CD Creator

Follow the steps below to install Direct CD and Easy CD Creator on your computer's hard disk. The installation procedure for each application is nearly identical.

Refer to the Readme file in the Cdcreatr folder on the CD-ROM for additional information.

- 1. Insert the TEAC CDR Software Suite CD-ROM (Figure 18) into your computer's CD-ROM drive or into the TEAC CD-Recorder.**

If the Autoplay function is enabled, an icon for the CD-ROM should appear on your desktop.

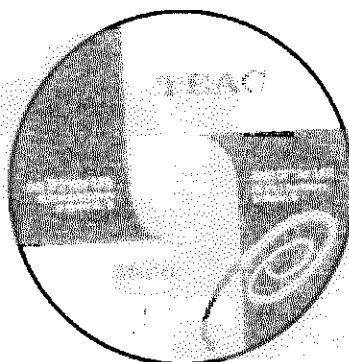

Figure 18. TEAC Adaptec CDR Software Suite CD-ROM

- 2. Double-click the CD-ROM icon on your desktop.**

If the CD-ROM icon does not appear on your desktop, double-click the My Computer icon, then double-click the icon for the CD-ROM drive.

The system displays a window showing the contents of the CD-ROM (Figure 19 on page 27):

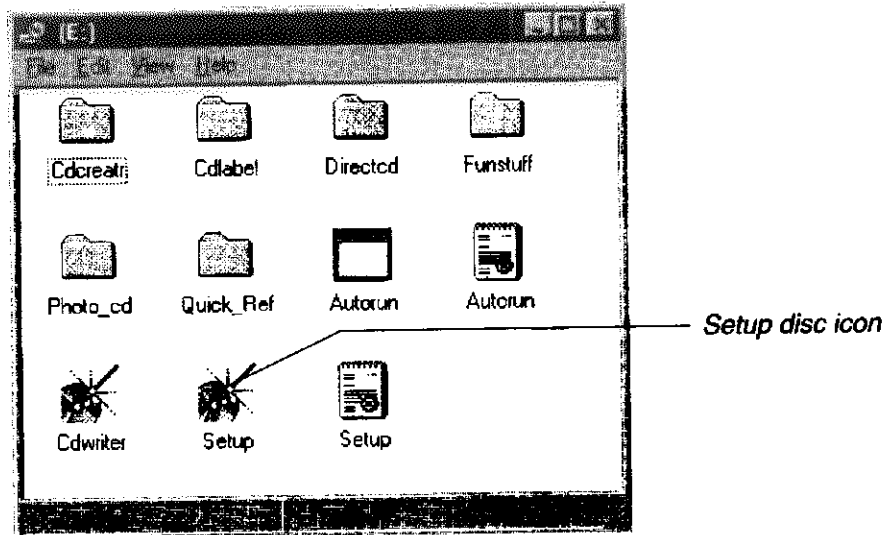

Figure 19. CD-ROM Contents

3. Double-click the left mouse button on the Setup disc icon.

The system displays the Adaptec "Direct CD" and "Easy CD Creator" Master Setup panel (Figure 20).

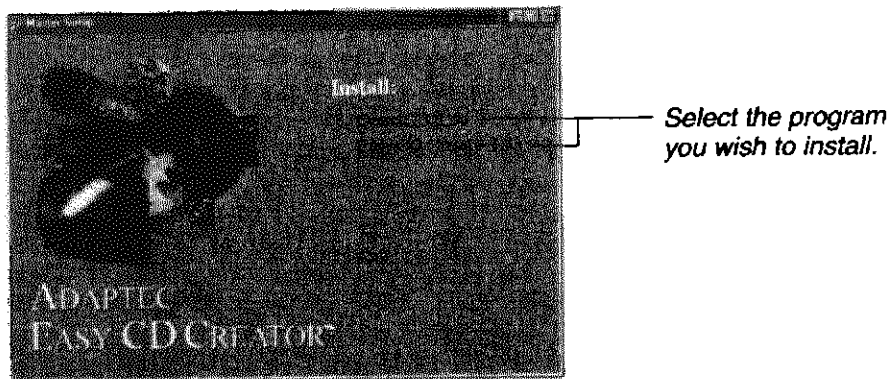

Figure 20. Adaptec Direct CD and Easy CD Creator Master Setup Panel

4. Click the left mouse button on the name of either application program: Direct CD or Easy CD Creator.

The system begins to install the software while displaying the following panel:

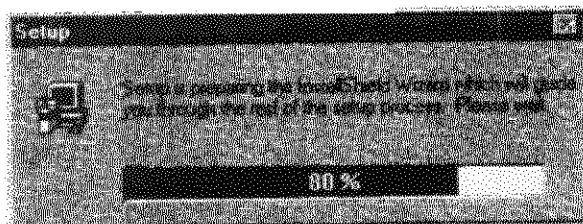

Figure 21. InstallShield Wizard Panel

The system then displays the following panel (Figure 22):

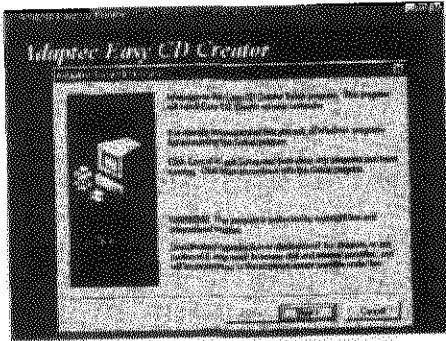

Figure 22. Setup Program Panel

5. **Exit all Windows programs, then click the Next button.**

The system displays a License Agreement (Figure 23).

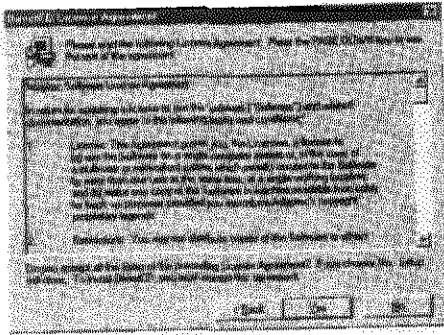

Figure 23. License Agreement Panel

6. **Please read the License Agreement and click Yes if you agree to its terms.**

- If you are installing Easy CD Creator, skip to step 8.
- If you are installing Direct CD, the system displays the following panel. This panel asks if you would like to install the included CD-RW utilities to work with CD-RW discs.

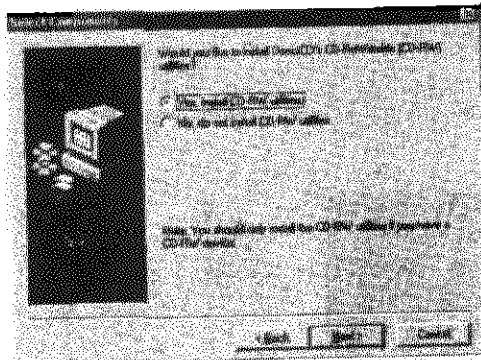

Figure 24. CD-RW Utilities Installation Panel

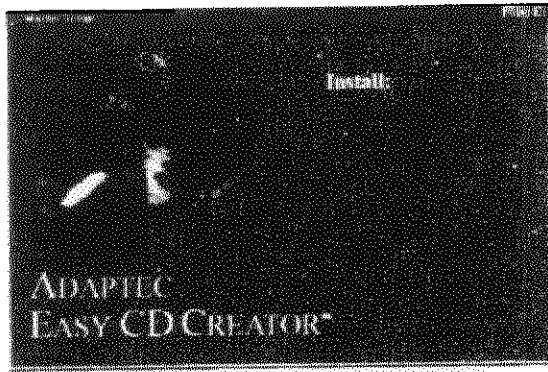

Figure 27. Main Installation Panel

10. Do one of the following:

- If you wish to continue and install the other program (Direct CD or Easy CD Creator), return to Step 4.
- If you have installed both programs, or if you wish to use the program you just installed immediately, click Exit.

The system displays the following panel:

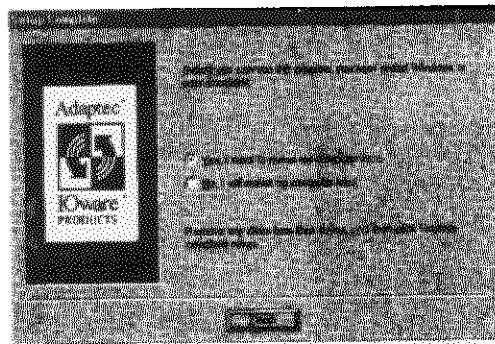

Figure 28. Restart Panel

11. Click Finish to restart your system.

The system restarts. The application(s) you installed are now ready for use.

About the User Guides for Direct CD and Easy CD Creator

For information on using Direct CD and Easy CD Creator, refer to the Acrobat PDF files included on the CD-ROM. These PDF files comprise the user documentation for the applications and are entitled:

- Adaptec Easy CD Creator User's Guide*
- Direct CD Quick Reference Guide.*

Adobe Acrobat PDF files can be viewed on-line or printed if you have Adobe Acrobat Reader software. You may download this software for free via the Internet from the website for Adobe Systems, Inc.:

<http://www.adobe.com/acrobat>.

The PDF files are located in the Quick_Ref folder on the CD-ROM, in subfolders named Creator and DirectCD (Figure 29). You can copy these PDF files to your hard disk for convenient reference.

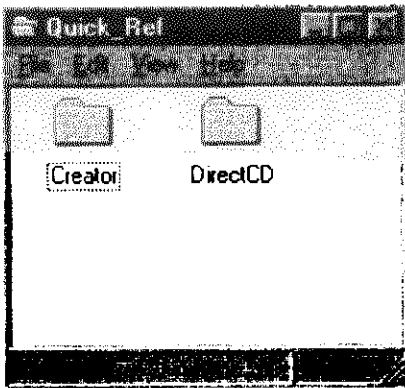

Figure 29. Quick_Ref Folder

Starting Direct CD

To start Direct CD, follow these steps:

1. Click the left mouse button on the Windows Start icon, and select from the pop-up menu: Programs-->Adaptec Direct CD-->Adaptec Direct CD.

The system displays an introductory screen followed by the first panel of the Direct CD Wizard (Figure 30), which will guide you through the process of creating an audio or data disc.

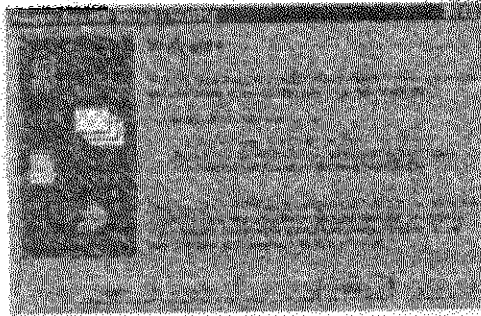

Figure 30 Direct CD Wizard

Using Direct CD

For information on using Direct CD, refer to the user documentation in PDF format on the CD-ROM (see "About the User Guides for Direct CD and Easy CD Creator" on page 31).

You may also refer to the on-line help system. Follow the steps below:

1. Click the left-mouse button on the Help menu icon.

Direct CD displays the Help menu

2. Select Help Topics from the menu.

Direct CD displays a list of topics. Review these topics for additional information on using Direct CD.

Starting Easy CD Creator

To start Easy CD Creator, follow these steps:

1. **Click the left mouse button on the Windows Start icon, and select from the pop-up menu: Programs-->Adaptec Easy CD Creator-->Easy CD Creator.**

The system displays an introductory screen followed by the first panel of the Easy CD Creator Wizard (Figure 31), which will guide you through the process of creating audio or data discs.

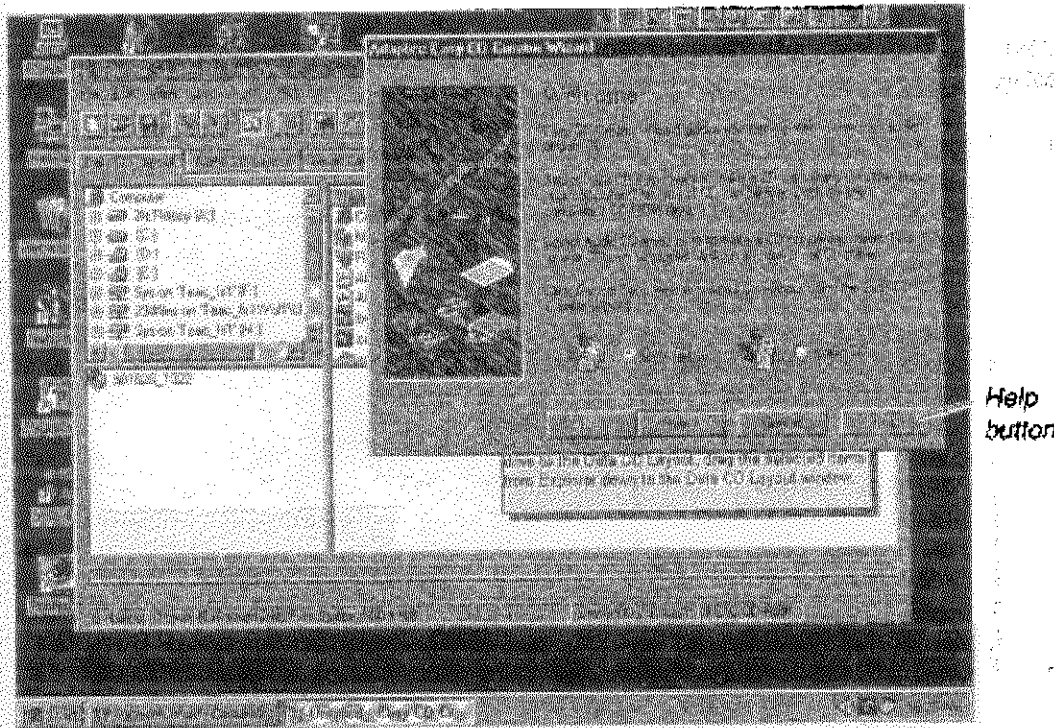

Figure 31. Easy CD Creator Wizard

Using Easy CD Creator

For information on using Easy CD Creator, refer to the user documentation in PDF format on the CD-ROM (see "About the User Guides for Direct CD and Easy CD Creator" on page 31).

You may also refer to the on-line help system. Follow the steps below:

1. **Click the left-mouse button on the Help button (refer to Figure 31).**
Easy CD Creator displays helpful on-line Easy CD Creator documentation.
2. **Select Help Topics from the menu.**
Easy CD Creator displays a list of topics. Review these topics for additional information on using Easy CD Creator.

Installing Other Programs

The CD-ROM also includes application programs called **CD Catalog** and **PhotoSuite SE**

CD Catalog is an application that enables you to browse and order CD-ROM labels and other accessories.

PhotoSuite SE is an image and photo viewing, editing, and archiving software application.

This section explains how to install these programs. Be sure to explore the CD-ROM for extra images and items of interest.

1. Double-click the left mouse button on the Funstuff folder.

Refer to Figure 19 on page 27 to help locate the Funstuff folder. Then refer to Figure 32 to install CD Catalog and PhotoSuite SE.

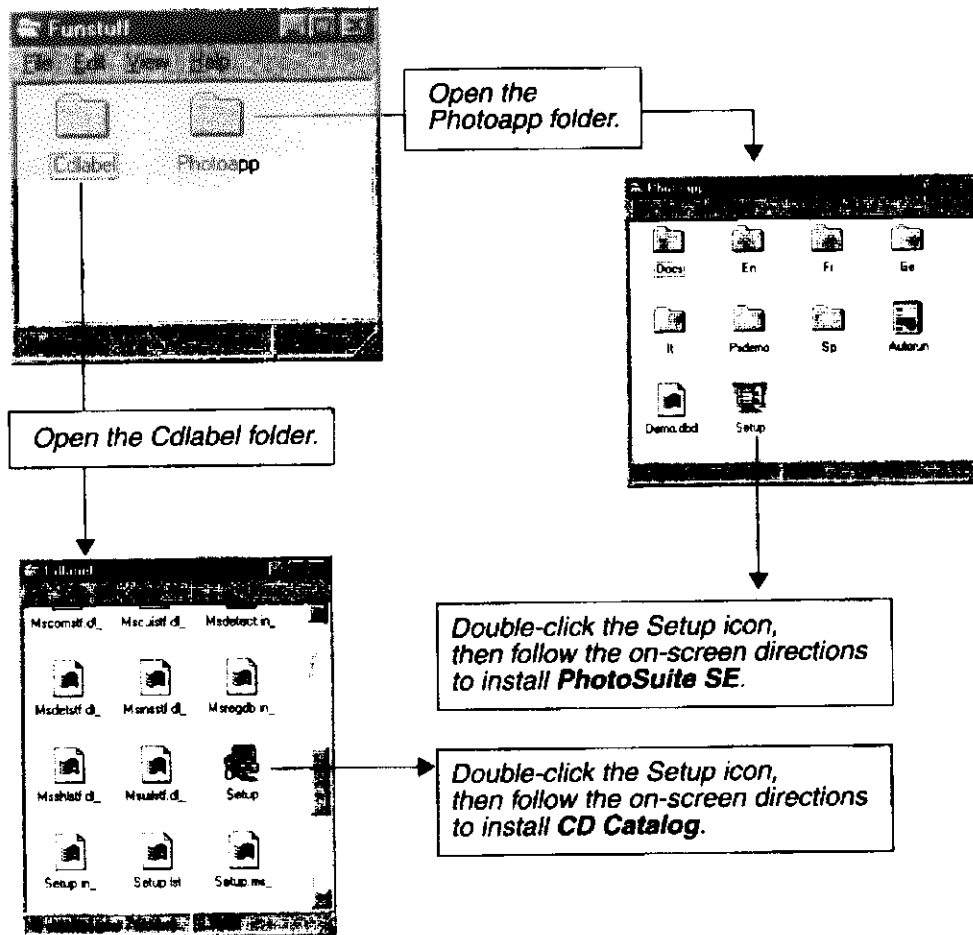

Figure 32. Installing Other Programs from the CD-ROM

Uninstalling Programs

To uninstall Easy CD Creator or the other programs discussed in this chapter, use the Windows Uninstall utility.

Click the left mouse button on the Windows Start icon, and select Control Panels-->Add/Remove Programs. Follow the prescribed steps to remove the programs. For additional information, refer to your Windows documentation.

Appendix A. About CD-R Discs

Handling Discs

- Handle compact discs only by their edges to avoid getting fingerprints on the surface. Do not touch the disc's data surface (non-label side).
- Do not place discs in direct sunlight, or in locations subject to high humidity, high temperatures, or dusty conditions.
- If cleaning the disc becomes necessary (erratic operation or visible dust or smudges), gently wipe the surface of the disc from the center to the outside edge. Do not use benzene, alcohol, thinner, or other solvents.

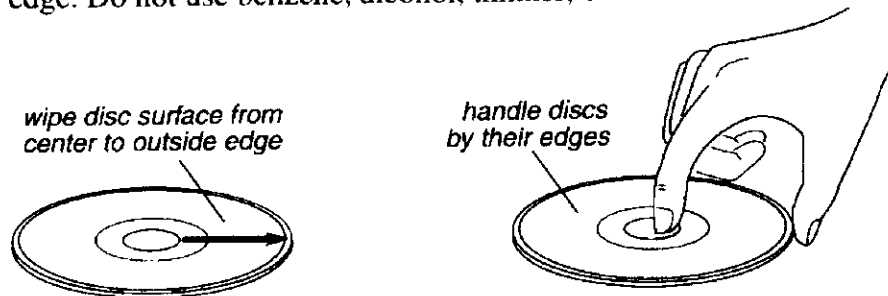

Figure 33. How to Handle Compact Discs

Recommended Media

One blank TEAC CD-R disc is included in the package with your CD-Recorder. Use only 74-minute blank media from TEAC or the following manufacturers:

Mitsui Toatsu Chemicals	800-682-3766	8X (MCI74 SP) 6X, 4X, 2X, 1X (MCI74)
Eastman Kodak	800-235-6325	6X, 4X, 2X
Taiyo Yuden	800-258-2496	6X, 4X, 2X, 1X
TDK Electronics	800-835-8273	4X, 2X, 1X
Mitsubishi Chemical America	800-347-5724	4X, 2X, 1X
Ricoh	800-626-8539	4X, 2X, 1X

Disc Formats

TEAC CD-Recorders utilize the following disc formats in both read and write operations:

CD-DA	74 minutes
CD-ROM Mode 1	650MB
CD-ROM XA Mode 2 (Form 1)	650MB
CD-ROM XA Mode 2 (Form 2)	738MB
Multi-session Photo CD	650MB
CD-I	650MB
Video CD	650MB

Loading and Ejecting Discs

To load a disc, first open the disc tray by pressing the eject button on the front of the drive. Place the disc on the disc tray with its label side facing up. Then press the eject button again to retract the disc tray back into the drive.

To eject a disc, press the eject button on the front of the drive to extend the disc tray (refer to Figure 34). Remove the disc from the disc tray and put it in its protective case. Then press the eject button again to retract the disc tray back into the drive.

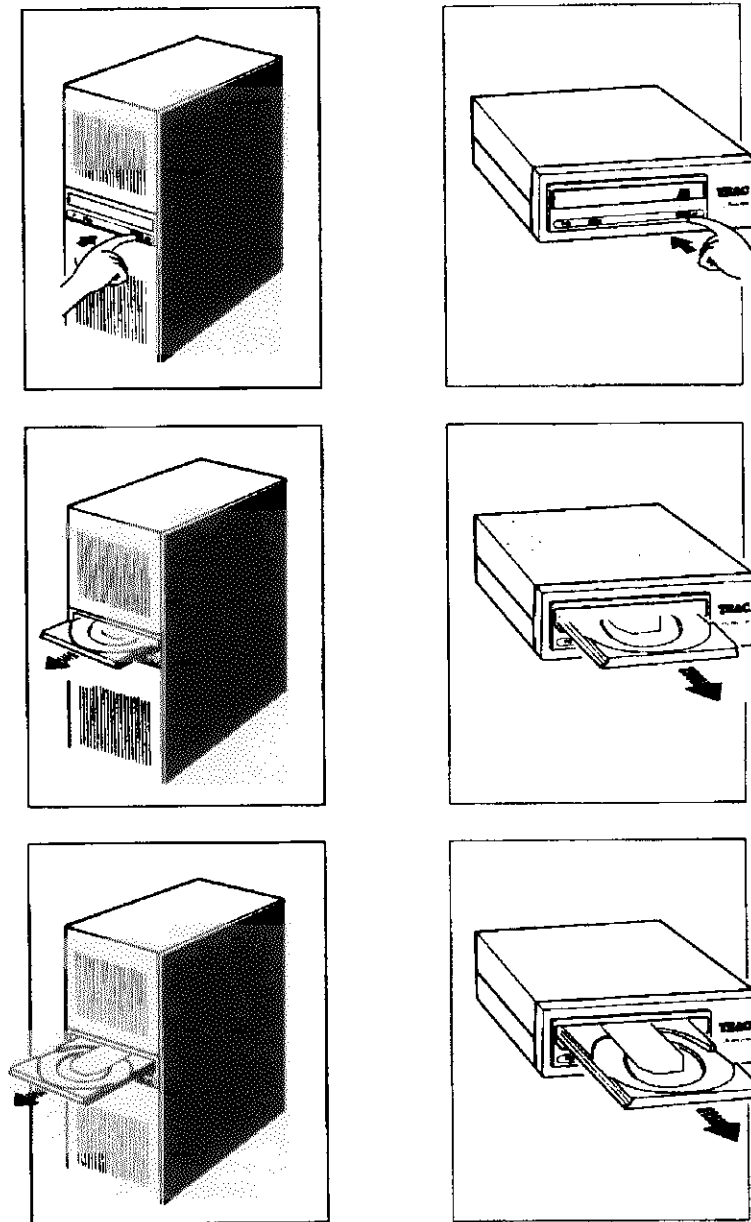

Figure 34. Ejecting the Disc Tray

Appendix B. Specifications

The following tables list the product specifications for TEAC internal and external CD-Recorders.

Internal CD-Recorder model

Model	6X24
Interface	Fast SCSI-2
Transfer Rate	Read: 24X maximum (3,600KBps) Write: 6X speed (900KBps) (also 4X, 2X, 1X)
Access Time	150 msec
Buffer Size	2MB
Formats	Single Session, Multi-Session, and Incremental
Disc Type	8cm/12cm; Audio CD; CD-ROM Mode-1; Mode-2 (Form1, Form2); XA ready; Video CD; CDI; Multi-Session Photo CD
Disc Loading	Power Tray (caddy not required)
Spindle Motor	Brushless
Front Panel	Built-in Headphone Jack, Volume Control Knob, and Power Eject Button
MTBF	100,000 POH
Dimensions	5.75"(W) x 1.6"(H) x 7.56"(D)
Weight	1.9 lbs
Power Supplies	+5VDC, +12VDC
Factory Presets	SCSI ID: 3; Parity check: Performed; Termination: Enabled
Audio Headphone Line-Out	0.8 ± 0.3Vrms at 32Ω 0.8 ± 0.3Vrms at 47Ω
Headphone Jack	3.5mm diameter stereo mini-headphone jack
Connection	50-pin SCSI connector
Installation	Horizontal, plus or minus 10°
Operating Temperature	5° C to 35° C (41° F to 95° F)
Storage Temperature	-30° C to 55° C (-22° F to 131° F)
Operating Humidity	20% to 80% (non-condensing)
Storage Humidity	10% to 80% (non-condensing)
Safety Standards	UL, CSA, TUV

External CD-Recorder models

Model	6X24, 8X24
Interface	Fast SCSI-2
Transfer Rate	Read: 24X maximum (3,600KBps) Write: 8X24 model: 8X speed (1200KBps) (also 6X, 4X, 2X, 1X) 6X24 model: 6X speed (900KBps) (also 4X, 2X, 1X)
Access Time	150 msec
Buffer Size	6X24 model: 2MB; 8X24 model: 6MB
Formats	Single Session, Multi-Session, and Incremental
Disc Type	8cm/12cm; Audio CD; CD-ROM Mode-1; Mode-2 (Form1, Form2); XA ready; Video CD; CDI; Multi-Session Photo CD
Disc Loading	Power Tray (Caddy not required)
Spindle Motor	Brushless
Front Panel	Built-in Headphone Jack, Volume Control Knob, and Power Eject Button
MTBF	100,000 POH
Dimensions	7.5"(W) x 2.5"(H) x 9.5"(D)
Weight	5.2 lbs.
Power Supplies	+5VDC, +12VDC
Factory Presets	SCSI ID: 6; Parity check: Performed; Termination: Disabled (terminator unmounted)
Audio Headphone Line-Out	0.8 ± 0.3Vrms at 32Ω 0.8 ± 0.3Vrms at 47Ω
Headphone Jack	3.5mm diameter stereo mini-headphone jack
Connection	Centronic 50-pin SCSI connector
Installation	Horizontal, plus or minus 10°
Operating Temperature	5° C to 35° C (41° F to 95° F)
Storage Temperature	-30° C to 55° C (-22° F to 131° F)
Operating Humidity	20% to 80% (non-condensing)
Storage Humidity	10% to 80% (non-condensing)
Safety Standards	UL

Appendix C. Technical Support

TECHNICAL SUPPORT:

North America

TEAC America, Inc (USA)
Monday - Friday, except for holidays.
From 8:00am to 5:00pm PST

VOICE: (323)727-4860
FAX: (323)869-8751
E-mail Support: dspdtsg@teac.com
Home page: <http://www.teac.com/>

Europe

**TEAC Deutschland GmbH ICP
Division (Germany)**

VOICE: (611)71-580
FAX: (611)71-5892
BBS: (611)71-5851
Home page: <http://www.teac.de>

TEAC UK Ltd.

VOICE: 923-225235
FAX: 923-23690
Home page: <http://www.teac.co.uk/>

TEAC France, S.A.

VOICE: (1)42-37-01-02
FAX: (1)42-37-65-45

Japan, Asia, & Middle East

TEAC Corporation, 3-7-3 Nakacho,
Musashino-sji, Tokio 180-0006 Japan
Field Service & Technical Support
Data Storage Products Sales and
Marketing Division

VOICE: (0422)52-5048
FAX On Demand: (0422)55-2554
BBS: (0429)62-7498 (8N1, LHA
compressed)
Home page: <http://www.teac.co.jp>

TEAC Australia PTY LTD

VOICE: (03)9644-2442
FAX: (03)9646-9187
Home page: <http://www.teac.com.au>