

USER'S MANUAL

Programmable DC Electronic Load

Models M97 Series

(Including M9717/M9717B/M9717C/M9718/M9718B)

AA Portable Power Corp.

Content

USER'S MANUAL	i
Chapter 1 Overview	1
Chapter 2 Technical Specifications	2
2.1 Main Technical Specifications	2
2.2 Electronic Load Dimension	4
Chapter 3 Quick Reference	5
3.1 Power-on-self-test	5
3.2 In Case Of Trouble	5
3.3 Front Panel Operation.....	6
3.4 Keypad Directions	7
3.5 Menu Operation	8
Chapter 4 Panel Operation	11
4.1 Basic Operation Mode	11
4.1.1 Constant Current Operation Mode (CC).....	11
4.1.1.1 Setting up a Standard Constant Current Mode	11
4.1.1.2 Loading and Unloading Constant Current Mode.....	12
4.1.1.3 Soft Start Constant Current Mode.....	13
4.1.1.4 Constant Current Shifting into Constant Voltage Mode.....	13
4.1.2 Constant Resistant Operation Mode(CR)	14
4.1.2.1 Setting up a Standard Constant Resistance Mode.....	15
4.1.2.2 Loading and Unloading Constant Resistance Mode.....	15
4.1.2.3 Constant Resistance Shifting into Constant Voltage Mode	16
4.1.3 Constant Voltage Operation Mode(CV).....	16
4.1.3.1 Setting up a Standard Constant Voltage Mode	17
4.1.3.2 Loading and Unloading Constant Voltage Mode	17
4.1.3.3 Soft Start Constant Voltage Mode	18
4.1.4 Constant Power Operation Mode(CW).....	19
4.1.4.1 Setting up a Standard Constant Power Mode	19
4.1.4.2 Loading and Unloading Constant Power Mode.....	19
4.2 Dynamic Testing Operation	20
4.2.1 Continuous Mode(CONTINUOUS).....	20
4.2.2 Pulse Mode(PULSE).....	21
4.2.3 Trigger Mode(TRIGGER).....	21
4.2.4 Setting up Dynamic testing operation Parameters	21
4.2.5 Waveform Control	22
4.2.5.1 Square Wave	22
4.2.5.2 Triangular Wave	22
4.2.5.3 Trapezoidal Wave	22
4.2.6 Trigger Control.....	22
4.2.7 List Function.....	23
4.2.7.1. List Operation	23
4.2.7.2 Executing List Function.....	23

4.2.8 Automatic Testing Function	24
4.2.8.1 Automatic Test Operation.....	24
4.2.8.2 Setting up Automatic Test Trigger Output Mode	25
4.2.8.3 Executing Automatic Test Function	26
4.3 Input Control.....	26
4.3.1 Short Circuit Operation(SHORT)	26
4.3.2 Input On/Off Operation	26
4.4 Electronic Load Operation Range.....	27
4.5 Protection Functions	27
4.5.1 Over Voltage Protection(OV).....	27
4.5.2 Over Current Protection(OC).....	28
4.5.3 Over Power Protection(OW).....	28
4.5.4 Input Polarity Reversed	28
4.5.5 Over Heat Protection(OH)	29
4.6 Remote Measurement Function.....	29
4.7 Battery Testing.....	29
4.8 Communication protocol.....	30
4.8.1 Introduction.....	30
4.8.2 Setup Baudrate.....	31
4.8.3 Data	32
4.8.4 Function Code	32
4.8.5 Error checking(CRC)	32
4.8.6 Complete Command Frame Analysis	32
4.8.7 Coil With The Register Address Allocation	35
4.8.8 The Definition Of The Command Register CMD.....	38
4.8.9 Common Operation Function Description	38
4.9 Remote operation	42
4.9.1 M-131Communication Cable.....	42
4.9.2 Communication between Power Supply and PC	43
Quick Reference.....	46

Chapter 1 Overview

M97series DC electronic load, as a new generation product of Maynuo Electrical Co., Ltd, is designed with high-performance chips, high speed, high accuracy and with resolution of 0.1 Mv and 0.01 mA (the basic accuracy is 0.03%, the basic current rise speed is 2.5 A/us). M97 series has a wide application in production line (cell phone charger, cell phone battery, electric vehicle battery, Switching power supplier, linear power supplier), research institutes, automotive electronics, aeronautics and astronautics, ships, solar cells, fuel cell, etc.

M97 series offers users with its novel design, rigorous process and attractive cost-effectiveness.

FEATURES

Six high speed operation modes: CC,CR,CV,CW,CC+CV,CR+CW
Over current, over voltage, over power, over heat, polarity reversed protection
High-luminance VFD screen with two lines& four channels display
Soft start time setting, carrying the power supplier according to the voltage value set
Battery testing and short-circuit function
Available for dynamic testing with rising edge / falling edge setting
Supporting external trigger input and output
External current waveform monitor terminal
Supporting remote voltage compensation and multidata storage
Power-on-self-test , software calibration and standard rack mount
Communication mode: TTL level Serial communication interface.

Chapter 2 Technical Specifications

2.1 Main Technical Specifications

Model 型号	M9717		M9717B		M9718		M9718B		
Input Rating 额定输入	Power	3600W		3600W		6000W		6000W	
	Current	0-240A		0-120A		0-240A		0-120A	
	Voltage	0-150V		0-500V		0-150V		0-500V	
CC Mode 定电流模式	Range	0-24A	0-240A	0-12A	0-120A	0-24A	0-240A	0-12A	0-120A
	Resolution	1mA	10mA	1mA	10mA	1mA	10mA	1mA	10mA
	Accuracy	0.05%+0.05%FS	0.1%+0.05%FS	0.05%+0.05%FS	0.1%+0.05%FS	0.05%+0.05%FS	0.1%+0.05%FS	0.05%+0.05%FS	0.1%+0.05%FS
CV Mode 定电压模式	Range	0.1-19.999V	0.1-150V	0.1-19.999V	0.1-500V	0.1-19.999V	0.1-150V	0.1-19.999V	0.1-500V
	Resolution	1mV	10mV	1mV	10mV	1mV	10mV	1mV	10mV
	Accuracy	0.03%+0.02%FS	0.03%+0.02%FS	0.03%+0.02%FS	0.03%+0.05%FS	0.03%+0.02%FS	0.03%+0.02%FS	0.03%+0.02%FS	0.03%+0.05%FS
CR Mode 定电阻模式 (当输入电压和电流值 ≥ 满量程的10%)	Range	0.03Ω -10K	0.03Ω -5K	0.03Ω -10K	0.03Ω -5K	0.3Ω -10K	0.3Ω -5K	0.03Ω -10K	0.03Ω -5K
	Resolution	16位	16位	16位	16位	16位	16位	16位	16位
	Accuracy	0.1%+0.1%FS	0.1%+0.1%FS	0.1%+0.1%FS	0.1%+0.1%FS	0.1%+0.1%FS	0.1%+0.1%FS	0.1%+0.1%FS	0.1%+0.1%FS
CW Mode 定功率模式 (当输入电压和电流值 ≥ 满量程的10%)	Range	0-3600W	0-3600W	0-3600W	0-3600W	0-3600W	0-6000W	0-6000W	0-6000W
	Resolution	1mW	10mW	1mW	10mW	1mW	10mW	1mW	10mW
	Accuracy	0.1%+0.1%FS	0.1%+0.1%FS	0.1%+0.1%FS	0.1%+0.1%FS	0.1%+0.1%FS	0.1%+0.1%FS	0.1%+0.1%FS	0.1%+0.1%FS
V Measurement 电压测量值	Voltage	0-19.999V	0-150V	0-19.999V	0-500V	0-19.999V	0-150V	0-19.999V	0-500V
	Resolution	1mV	10mV	1mV	10mV	1mV	10mV	1mV	10mV
	Accuracy	0.015%+0.03%FS	0.015%+0.03%FS	0.015%+0.03%FS	0.015%+0.05%FS	0.015%+0.03%FS	0.015%+0.03%FS	0.015%+0.03%FS	0.015%+0.05%FS
I Measurement 电流测量值	Current	0-24A	0-240A	0-12A	0-120A	0-24A	0-240A	0-12A	0-120A
	Resolution	0.1mA	1mA	0.1mA	1mA	0.1mA	1mA	0.1mA	1mA
	Accuracy	0.03%+0.08%FS	0.1%+0.08%FS	0.03%+0.08%FS	0.1%+0.08%FS	0.03%+0.08%FS	0.1%+0.08%FS	0.03%+0.08%FS	0.1%+0.08%FS
W Measurement 功率测量值 (当输入电压和电流值 ≥ 满量程的10%)	Watt	100W	3600W	100W	3600W	100W	6000W	100W	6000W
	Resolution	1mW	10mW	1mW	10mW	1mW	10mW	1mW	10mW
	Accuracy	0.1%+0.1%FS	0.1%+0.1%FS	0.1%+0.1%FS	0.1%+0.1%FS	0.1%+0.1%FS	0.1%+0.1%FS	0.1%+0.1%FS	0.1%+0.1%FS
Battery Measurement 电池测试功能		Battery Input: 0.5-120V; Max. Measurement: Capacity=999/H; Resolution=0.1mA; Time Range=1S-16HS							
Dynamic Measurement 动态测试功能		Transition List: 0-25kHz; 5A/uS; T1&T2: 60uS-999S; Accuracy: ± 15% offset+10% FS							
CC soft-startup Time 电流软启动时间		1 mS; 2 mS; 5mS; 10mS; 20 mS; 50 mS; 100 mS; 200 mS Accuracy: ± 15% offset+10% FS							
Short Circuit 短路功能	Current(CC)	≈ 26.4A	≈ 264A	≈ 13.2A	≈ 132A	≈ 26.4A	≈ 264A	≈ 13.2A	132A
	Voltage(CV)	0V		0V		0V		0V	
	Resistance(CR)	≈ 8mΩ		≈ 45mΩ		≈ 7mΩ		≈ 35mΩ	
Temperature	Operating	0 ~ 40°C		0 ~ 40°C		0 ~ 40°C		0 ~ 40°C	
	Nonoperating	-10°C ~ 70°C		-10°C ~ 70°C		-10°C ~ 70°C		-10°C ~ 70°C	
Dimension	W*H*D(mm)	575*465*355							
Weight	Kg	70							

Model	M9717C		
Input Rating	Power	3600W	
	Current	0-480A	
	Voltage	0-150V	
CC Mode	Range	0-48A	0-480A
	Resolution	1mA	10mA
	Accuracy	0.1%+0.05%FS	0.15%+0.1%FS
CV Mode	Range	0.1-19.999V	0.1-150V
	Resolution	1mV	10mV
	Accuracy	0.03%+0.02%FS	0.03%+0.02%FS
CR Mode (Voltage and current input value $\geq 10\%$ full measurement)	Range	0.03 Ω -10K	0.03 Ω -5K
	Resolution	16 bit	16 bit
	Accuracy	0.1%+0.1%FS	0.2%+0.15%FS
CW Mode (Voltage and current input value $\geq 10\%$ full measurement)	Range	0-3600W	0-3600W
	Resolution	1mW	10mW
	Accuracy	0.1%+0.1%FS	0.2%+0.15%FS
V Measurement	Voltage	0-19.999V	0-150V
	Resolution	1mV	10mV
	Accuracy	0.015%+0.03%FS	0.015%+0.03%FS
I Measurement	Current	0-48A	0-480A
	Resolution	0.1mA	1mA
	Accuracy	0.1%+0.15%FS	0.15%+0.2%FS
W Measurement (Voltage and current input value $\geq 10\%$ full measurement)	Watt	100W	3600W
	Resolution	1mW	10mW
	Accuracy	0.1%+0.2%FS	0.2%+0.15%FS
Battery Measurement	Battery Input: 0.5-120V; Max. Measurement: Capacity=999/H; Resolution=0.1mA; Time Range=1S-16HS		
Dynamic Measurement	Transition List: 0-25kHz; 5A/uS; T1&T2: 60uS-999S; Accuracy: $\pm 15\%$ offset+10% FS		
CC soft-startup Time	1 mS; 2 mS; 5mS; 10mS; 20 mS; 50 mS; 100 mS; 200 mS Accuracy: $\pm 15\%$ offset+10% FS		
Short Circuit	Current(CC)	∞	∞
	Voltage(CV)	0V	
	Resistance(CR)	∞ 3.8m Ω	
Temperature	Operating	0 ~ 40°C	
	Nonoperating	-10°C ~ 70°C	
Dimension	W*H*D(mm)	575*465*355	
Weight	Kg	70	

2.2 Electronic Load Dimension

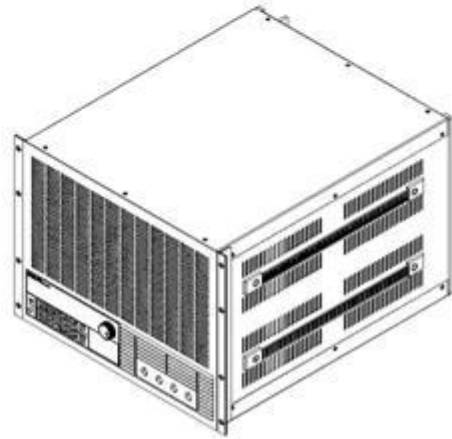
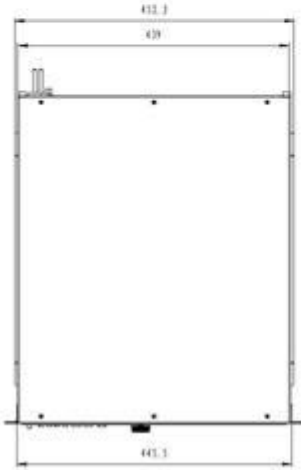
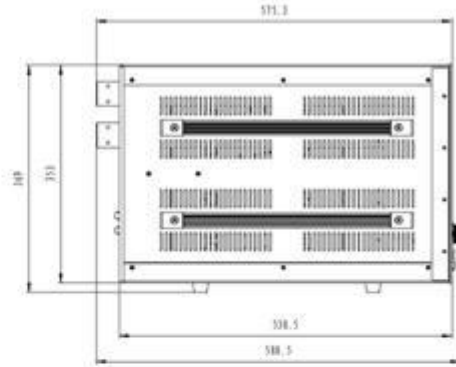
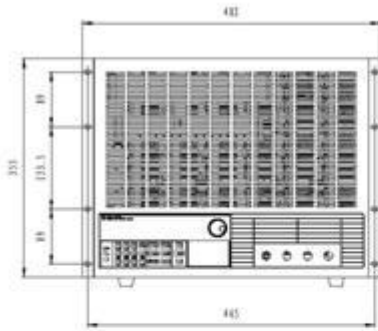

AA Portable

Chapter 3 Quick Reference

3.1 Power-on-self-test

Verify that you have received the following items with your power supplier. If anything is missing, contact your nearest Sales Office.

- One power cord for your location
- The user's manual
- One CD(only when you have bought communication accessories)
- One communication cable (only when you have bought communication accessories)

At first, please make sure the electronic load has been correctly connected and powered on. Please refer to the following for the detailed operation steps.

Procedure	Display	Explanation
1. Power on the electronic load	SYSTEM SELF TEST Vxxx	The electronic load start power-on-self-test and the VFD display shows the software serial No.
2. Wait for 1s after turn on electronic load	EPROM ERROR	EEPROM damage or lost data of last power off.
	ERROR CAL.DATA	EEPROM lost calibration data.
3. Wait for another 2S once ERROR occurred	xxxxxxxV xxxxxxxA xxxxxxxW xxxxxxxX	Display the actual input voltage and current value, actual power value and setting value.

3.2 In Case Of Trouble

If electronic load fails to run during power-on operation, the following test will help you to solve the problems that might be encountered.

- 1) Make sure if you have connected the power properly and On/Off switch has been pressed.
- 2) Check the power voltage setting.

There are two voltages which can make load work: 110V or 220V, Please make sure you get the right voltage in accordance to the voltage in your area.

- 3) Check the fuse of load.

If fuse is blowout, please change another fuse with the following specification.

Model	Fuse specification (110VAC)	Fuse specification (220VAC)
M9717	T2.5A 250V	T1.25A 250V
M9717B	T2.5A 250V	T1.25A 250V
M9717C	T2.5A 250V	T1.25A 250V
M9718	T2.5A 250V	T1.25A 250V
M9718B	T2.5A 250V	T1.25A 250V

4) . Replace the Fuse

Open the plastic cover in the rear panel of the electronic load with a flat screwdriver.(see the table 3.1) and find the blowout fuse. Then replace the bad fuse with a new one

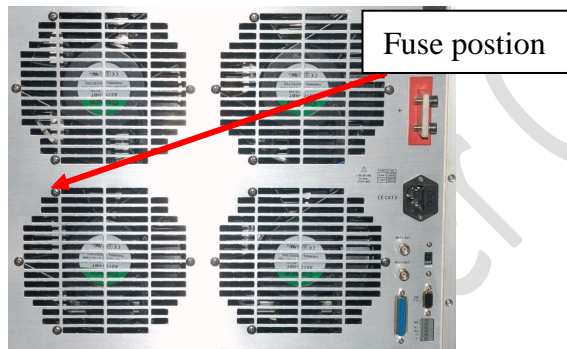

Picture 3.1 Fuse Location

3.3 Front Panel Operation

Please refer to the picture3.2 for the front panel of M97 electronic load.



Picture 3.2 Front panel

①The upper half is black VFD display screen and knob

②The bottom half, left side to right side, is Numeric keys 0-9, ESC key, Function keys, Up-Down keys, Enter key, Input terminal and Output terminal.

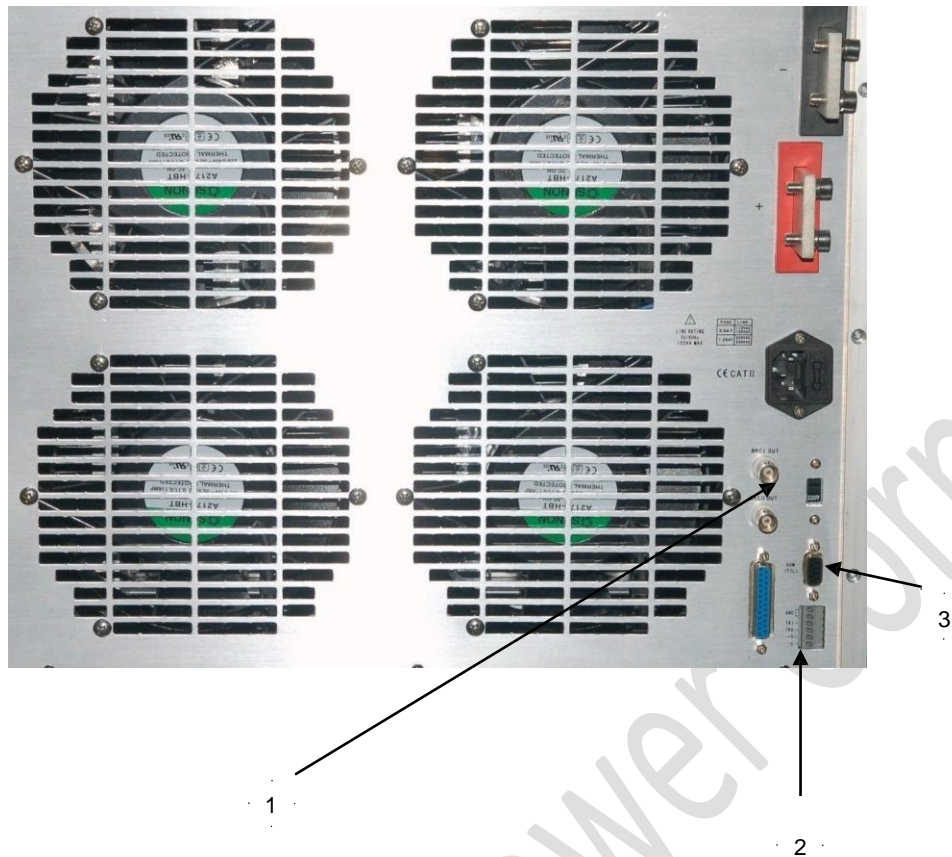

Picture 3.3 The back panel of M97 Series electronic load

- 1 0-full range current , in correspond to 0-10V output , Oscillograph can be connected by here to observe dynamic waveforms.
- 2 Remote Measuremnt terminals and trigger input/output interface
- 3 Multifunctional communication interface RS232,RS485,USB

3.4 Keypad Directions

1 ~ 9	0-9 numeric keys
Esc	Esc key (can be exited from any working condition)
I-Set	Switch to CC mode Setting up a constant current
V-Set	Switch to CV mode Setting up a constant voltage
P-Set	Switch to CW mode Setting up a constant power
	Switch to CR mode Setting up a constant resistance
	Multi-purpose Used together with multifunction key to perform diversity functions and applications(for example: shift+Menu can perform menu function)

On/Off	Turn on/off Load
	Increasing setup values
	decreasing setup values
Enter	Confirm key

3.5 Menu Operation

Press the key **Shift+Menu** to access to the menu function and the VFD display screen shows the menu items. Select the menu items by pressing the **▲** and **▼** keys or by rotating the knob, and then press the key **Enter** to enter in the menu item you wanted. Or you can press the key **Esc** to return to the last menu.

MENU		
CONFIG		
	INPUT RECALL	Setting the output to the same state at last time when the load is turned off or to the OFF state when the electronic load supplier is powered on
	ON	Setting the same state as last time you turned off the electronic load
	OFF	Setting the output to OFF state when the electronic load is powered on. The load will work at CC mode
	KEY SOUND SET	Setting the key sound
	ON	The buzzer will sound when any key was pressed.
	OFF	the buzzer will not sound when any key was pressed
	CONNECT MODE	Connect mode
	MAXTIDLEXING	Multi
	SEPARATE	Single
	BAUDRATE SET	Setting the Baudrate
	2400	
	9600	
	14400	
	28800	
	57600	
	115200	
	COMM.PARITY	Setting Comm. Parity mode
	NONE	None Parity
	EVEN	Even Parity
	ODD	Odd Parity
	ADDRESS SET	Setting Address

	1~200	The address is the input number (1-200).
	KEY LOCK SET	Setting the keyboard unlocking password(when it is 0 or null, there is no password set)
	EXIT	
SYSTEM SET		
	MAX CURRENT SET	Setting the maximum current. If the maximum current is higher than 3A, it is high range. Otherwise, it is low range.
	MAX VOLTAGE SET	Setting the maximum Voltage. If the maximum voltage is higher than 20V, it is high range. Otherwise, it is low range.
	MAX POWER SET	Setup the Maximum Power.
	TERMINAL SET	Choosing the input terminal
	FRONT	Choose the input terminal at the front panel
	BACK	Choose the input terminal at the back panel
	EXIT	
LIST		
	LOAD LIST	Choose list files, 1~8
	EDIT LIST	Edit list files
	MINIMUM TIME	Edit minimum time(0.02~1310.7mS)
	LIST MODE	LIST output mode
	CONTINUOUS	Continuous mode
	END HOLD	Remains to the last output voltage level after the whole steps are executed successfully
	END RESET	Keep load off state after the whole steps are executed successfully
	STEP LENGTH	Step length(1~200)
	STEP n	1~whole step length
	CURRENT	Set current
	TIME	Duration
	EXIT	
AUTO TEST		
	LOAD AUTO TEST	Choose automatic test files 1~8
	EDIT AUTO TEST	Edit automatic test files
	STEP LENGTH	Set the whole step length
	STEP n	
	WORK MODE	
	LOAD OFF MODE	Load off mode
	CC MODE	Constant current mode
	CV MODE	Constant voltage mode
	CP MODE	Constant power mode
	CR MODE	Constant resistance mode
	SHORT MODE	Short circuit mode

	TEST MODE	Qualification testing mode
	TEST CURRENT	Test current
	TEST VOLTAGE	Test voltage
	TEST POWER	Test power
	TEST RESI	Test resistance
	DELAY TIME	Test delay time(0.2~25.5S)
	INPUT xxxx	Input the parameters set, for example: CC mode, 1A
	MINIMUM xxxx	Input the minimum lower limit
	MAXIMUM xxxx	Input the maximum upper limit
SETUP AUTO TEST		
	TRIGGER	Trigger output selection
	WHEN PASS	Trigger once when passing the test
	WHEN FAIL	Trigger once when failing the test
	WHEN TEST END	Trigger output is initiated when test ends
	DISABLE	Disable trigger output
	OUTPUT	Output electrical characteristics selection
	PULSE	Pulse output
	LEVEL	Voltage level output
EXIT		
EXIT		

Chapter 4 Panel Operation

4.1 Basic Operation Mode

There are four operation modes for electronic load:

1. Constant current (CC)
2. Constant voltage (CV)
3. Constant resistance (CR)
4. Constant power (CW)

4.1.1 Constant Current Operation Mode (CC)

In this mode, the electronic load will sink a current in accordance with the programmed value regardless of the input voltage. Please refer to the picture 4.1. If maximum current value of the measured power supplier is less than the constant current value set, the electronic load might fail to adjust itself to the constant current and the voltage of the measured power supplier could be changed to be low.

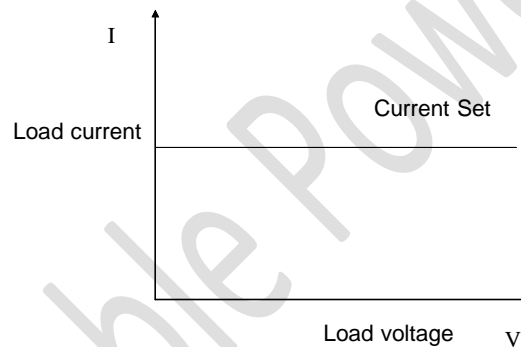

4.1 Constant Current Mode

4.1.1.1 Setting up a Standard Constant Current Mode

Press the key **I-SET**, then the VFD display will show **STANDARD CURR=xxxxxxxA**, the current constant current value. Press the numeric keys and decimal point key to enter the constant current value required, followed by pressing the key **Enter** to confirm. Then the load will enter into the standard constant current.

If the input state is in **OFF** state, then the right upper corner of the VFD display will show the word **OFF**. Press the key **On/Off** to change the input state into **ON** state. Then the right upper corner of the VFD display will show the word **CC** or **Unreg**. Showing **CC** means the load has been successfully set into the expected constant current value; showing **Unreg** means the load couldn't adjust itself to the expected constant current value. Please check if the measured power supplier has been correctly connected and turned on; make sure if the expected constant current value is in the range of the measured power supplier.

If you want to fine tune the constant current value, you can rotate the selective encoder knob to adjust the value. Rotating clockwise is to increase the value while rotating anti-clockwise is to decrease the value.

Note: if the constant current value you want to set is beyond the maximum constant current value of the load, the current value will stop to be increased even if you still rotate the selective encoder knob clockwise. Then the right lower corner of the VFD display shows the constant current value you set, among which, a cursor shows under one number, meaning this number requires fine tuning. If users want to change the fine tuning accuracy, just press the rotary encoder knob in which a key is included. Every time when you press the rotary encoder once, the cursor will move forward to the previous number.

4.1.1.2 Loading and Unloading Constant Current Mode

Loading and unloading mode can well protect the measured power supplier from damage. When the voltage of the measured power supplier begins to increase, the load will automatically adjust itself to the open-circuit state, and begin to carry the measured power supplier and adjust itself to the current value set only when the voltage of the measured power supplier has been increased to the **ONSET** loading voltage. When the voltage of the measured power supplier begins to decrease and has been decreased to the **OFFSET** unloading value, the load will automatically adjust itself to the open-circuit state. If the **ONSET** loading voltage value is higher than the **OFFSET** unloading voltage value, the load can be avoided from frequent carrying and unloading at the critical point of unloading voltage; thus the measured power supplier can be well protected.

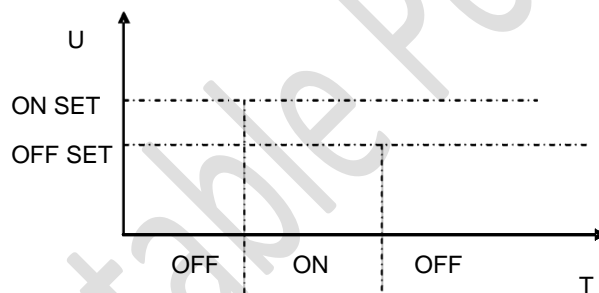

Picture 4.2 Loading and Unloading Mode

When in standard constant current mode, press the key **Shift+1(V_Level)** and enter into the loading and unloading constant current mode. When the VFD display shows **ONSET VOLT=xxxxxxxV** indicating the current loading voltage, press the numeric keys and decimal point key to enter the loading voltage value required, followed by pressing the key **Enter** to confirm. Then the VFD will show **OFFSET VOLT=xxxxxxxV** indicating the current unloading voltage. Press the numeric keys and decimal point key to enter the unloading voltage value required, followed by pressing the key **Enter** to confirm. In this way, the load will enter into the loading and unloading constant current mode.

If the input state is in **OFF** state, then the right upper corner of the VFD display will show the word **OFF**. Press the key **On/Off** to change the input state into **ON** state. Then the right upper corner of the VFD display will show the word **CC_UN** or **Unreg**. Showing **CC_UN** means the load has successfully set into the expected constant current value; showing **Unreg** means the load could not adjust itself to the expected

constant current value. Please check if the measured power supplier has been correctly connected and turned on; make sure if the voltage is normal and if the expected constant current value is in the range of the measured power supplier.

In loading and unloading constant current mode, press the key **Shift+1(V_Level)**, the load will back into the standard constant current mode.

4.1.1.3 Soft Start Constant Current Mode

Soft start constant current mode functions as an inductive load, simulating inductance value which is in direct proportion with the rise time of soft start. In this mode, the measured power supplier can be avoided from current strike damage.

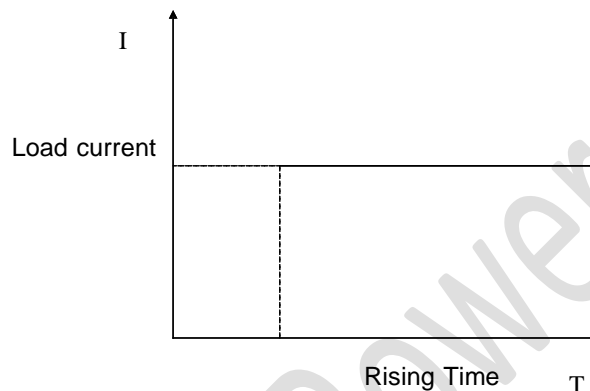

Picture 4.3 Soft Start Current Mode

When in standard constant current mode, press the key **Shift+2(S_Start)** to enter into the soft start constant current mode. When the VFD display shows **Rising TM=xxxxxxxvmS** indicating the current rising time, press the numeric keys and decimal point key to enter the rising time required, followed by pressing the key **Enter**. In this way, the load will enter into the soft start constant current mode.

If the input state is in **OFF** state, then the right upper corner of the VFD display will show the word **OFF**. Press the key **On/Off** to change the input state into **ON** state. Then the right upper corner of the VFD display will show the word **CC_S** or **Unreg**. Showing **CC_S** means the load has been successfully set into the expected constant current value; showing **Unreg** means the load couldn't adjust itself to the expected constant current value. Please check if the measured power supplier has been correctly connected and turned on; make sure if the expected constant current value is in the range of the measured power supplier.

In loading and unloading constant current mode, press the key **Shift+2(S_Start)**, the load will back into the standard constant current mode.

Note: The rise time set is automatically regulated to be the round number times of 20uS.

4.1.1.4 Constant Current Shifting into Constant Voltage Mode

In constant current shifting into constant voltage mode, the measured power supplier can be avoided from current strike damage.

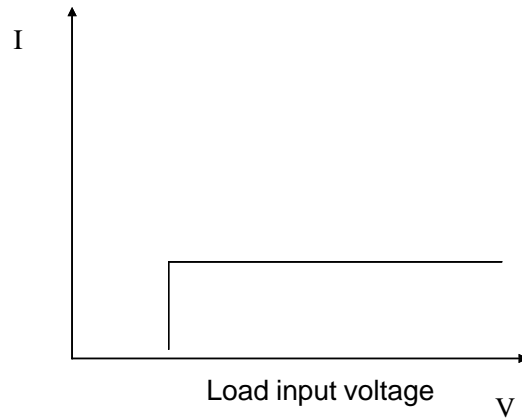

Picture 4.4 Constant Current Shifting into Constant Voltage Mode

When in standard constant current mode, press the key **Shift+4(CC+CV)** to enter into the constant current shifting into constant voltage mode. When the VFD display shows **CC TO CV VOLT=xxxxxxxV** indicating the current constant voltage value, press the numeric keys and decimal point key to enter the constant voltage value required followed by pressing the key **Enter** to confirm. In this way, the load will enter into the constant current shifting into constant voltage mode.

If the input state is in **OFF** state, then the right upper corner of the VFD display will show the word **OFF**. Press the key **On/Off** to change the input state into **ON** state. Then the right upper corner of the VFD display will show the word **CC+CV** or **Unreg**. Showing **CC+CV** means the load has been successfully set into the expected constant current value; showing **Unreg** means the load could not adjust itself to the expected constant current value. Please check if the measured power supplier has been correctly connected and turned on; make sure if the voltage is normal.

In loading and unloading constant current mode, press the key **Shift+4(CC+CV)**, the load will back into the standard constant current mode.

4.1.2 Constant Resistant Operation Mode(CR)

In this mode, the module will sink a current linearly proportional to the input voltage in accordance with the programmed resistance. Please refer to the picture 4.5.

Note: when the voltage of the measured power supplier is too high and the resistance set is too low, it will result in the consumed current higher than the maxim output current of the measured power supplier, or result in the loads failing to adjust itself automatically to the constant resistance, even result in the load shock.

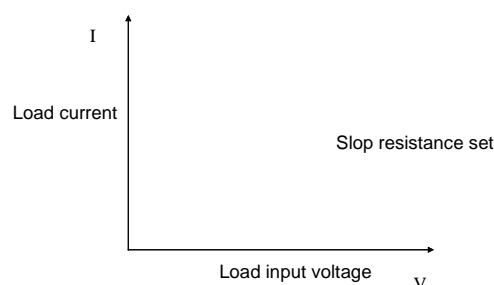

Picture 4.5 Constant Resistance Mode

4.1.2.1 Setting up a Standard Constant Resistance Mode

Press the key **R-SET**, then the VFD display will show **STANDARD RESI=xxxxxxxΩ** indicating the current constant resistance. Then Press the numeric keys and decimal point key to enter the constant resistance value required, followed by pressing the key **Enter**. In this way, the load will enter into the standard constant resistance mode.

If the input state is in **OFF** state, then the right upper corner of the VFD display will show the word **OFF**. Press the key **On/Off** to change the input state into **ON** state. Then the right upper corner of the VFD display will show the word **CR** or **Unreg**. Showing **CR** means the load has been successfully set into the expected constant resistance value; showing **Unreg** means the load couldnot adjust itself to the expected constant resistance value. Please check if the measured power supplier has been correctly connected and turned on; make sure if the output current of the measured power supplier is in the range of the current value that the expected resistance can absorb.

If you want to fine tune the constant resistance value, you can rotate the selective encoder knob to adjust the value. Rotating clockwise is to increase the value while rotating anti-clockwise is to decrease the value. Then the right lower corner of the VFD display shows the constant resistance value you set, among which, a cursor shows under one number, meaning this number requires fine tuning. If users want to change the fine tuning accuracy, just press the rotary encoder knob in which a key is included. Every time when you press the rotary encoder once, the cursor will move forward to the previous number.

4.1.2.2 Loading and Unloading Constant Resistance Mode

As for the loading and unloading mode theory, please refer to the 3.1.1.2 illustration.

When in standard constant resistance mode, press the key **Shift+1(V_Level)**to enter into the constant loading and unloading constant resistance mode. When the VFD display shows **ONSET VOLT=xxxxxxxV** indicating the current loading voltage, press the numeric keys and decimal point key to enter the loading voltage value required followed by pressing the key **Enter** to confirm. Then the VFD will shows **OFFSET VOLT=xxxxxxxV** indicating the current unloading voltage. Press the numeric keys and decimal point key to enter the unloading voltage value required, followed by pressing the key **Enter** to confirm. In this way, the load will enter into the loading and unloading constant resistance mode.

If the input state is in **OFF** state, then the right upper corner of the VFD display will show the word **OFF**. Press the key **On/Off** to change the input state into **ON** state. Then the right upper corner of the VFD display will show the word **CR_UN** or **Unreg**. Showing **CR_UN** means the load has been successfully set into the expected constant resistance value; showing **Unreg** means the load could not adjust itself to the expected constant resistance value. Please check if the measured power supplier has been correctly connected and turned on; make sure if the voltage is normal and if the output current of the measured power supplier is in the range of the current value that the expected resistance can absorb.

In loading and unloading constant current mode, press the key **Shift+1(V_Level)**, the load will back into the standard constant resistance mode.

4.1.2.3 Constant Resistance Shifting into Constant Voltage Mode

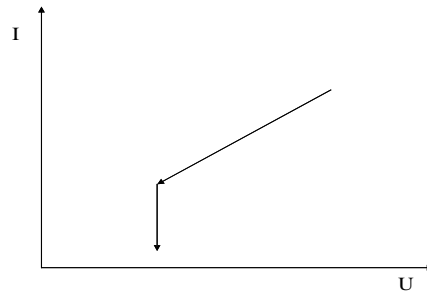

Picture 4.6 Constant Resistance Shifting into Constant Voltage Mode

In constant resistance shifting into constant voltage mode, the measured power supplier can be avoided from current strike damage.

When in standard constant current mode, press the key **Shift+5(CR+CV)** to enter into the constant current shifting into constant voltage mode. When the VFD display shows **CR TO CV VOLT=xxxxxxxV** indicating the current constant voltage value, press the numeric keys and decimal point key to enter the constant voltage value required followed by pressing the key **Enter** to confirm. In this way, the load will enter into the constant resistance shifting into constant voltage mode.

If the input state is in **OFF** state, then the right upper corner of the VFD display will show the word **OFF**. Press the key **On/Off** to change the input state into **ON** state. Then the right upper corner of the VFD display will show the word **CR+CV** or **Unreg**. Showing **CR+CV** means the load has been successfully set into the expected constant resistance value; showing **Unreg** means the load could not adjust itself to the expected constant resistance value. Please check if the measured power supplier has been correctly connected and turned on; make sure if the voltage is normal.

In loading and unloading constant resistance mode, press the key **Shift+5(CR+CV)**, the load will back into the standard constant resistance mode.

4.1.3 Constant Voltage Operation Mode(CV)

In this mode, the electronic load will attempt to sink enough current to control the source voltage to the programmed value. Please refer to the picture 4.7. Note: When the voltage of the measured power supplier is less than the voltage value set or the maximum input current is beyond the maximum current that the load can absorb, the load couldn't control the voltage to the value set.

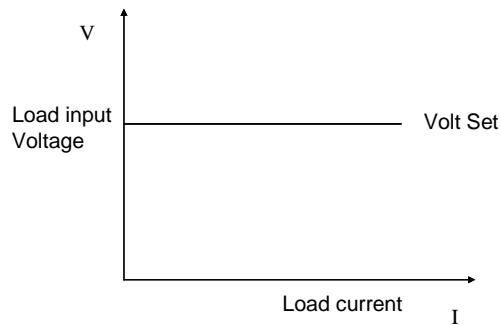

Picture4.7 Constant Voltage Mode

4.1.3.1 Setting up a Standard Constant Voltage Mode

Press the key **V-SET**, then the VFD display will show **STANDARD VOLT=xxxxxxxV** indicating the current constant voltage value. Then Press the numeric keys and decimal point key to enter the constant voltage value required, followed by pressing the key **Enter**. In this way, the load will enter into the standard constant voltage mode.

If the input state is in **OFF** state, then the right upper corner of the VFD display will show the word **OFF**. Press the key **On/Off** to change the input state into **ON** state. Then the right upper corner of the VFD display will show the word **CV** or **Unreg**. Showing **CV** means the load has been successfully set into the expected constant voltage value; showing **Unreg** means the load couldn't adjust itself to the expected constant voltage value. Please check if the measured power supplier has been correctly connected and turned on; make sure if the voltage of the measured power supplier is normal and if the output current is beyond the maximum current that the load can carry.

If you want to fine tune the constant voltage value, you can rotate the selective encoder knob locating at the right upper corner of the front panel to adjust the value. Rotating clockwise is to increase the value while rotating anti-clockwise is to decrease the value. Note: if the constant voltage value you want to set is beyond the maximum constant voltage value of the load, the current value will stop to be increased even if you still rotate the selective encoder knob clockwise. Then the right lower corner of the VFD display shows the constant voltage value you set, among which, a cursor shows under one number, meaning this number requires fine tuning. If users want to change the fine tuning accuracy, just press the rotary encoder knob in which a key is included. Every time when you press the rotary encoder once, the cursor will move forward to the previous number.

4.1.3.2 Loading and Unloading Constant Voltage Mode

As for the loading and unloading mode theory, please refer to the 3.1.1.2 illustration.

When in standard constant voltage mode, press the key **Shift+1(V_Level)** to enter into the constant loading and unloading constant voltage mode. When the VFD display shows **ONSET VOLT=xxxxxxxV** indicating the current loading voltage, press the numeric keys and decimal point key to enter the loading voltage value required followed by pressing the key **Enter** to confirm. Then the VFD will shows **OFFSET VOLT=xxxxxxxV** indicating the current unloading voltage. Press the numeric keys and decimal point key to enter the

unloading voltage value required, followed by pressing the key **Enter** to confirm. In this way, the load will enter into the loading and unloading constant voltage mode.

If the input state is in **OFF** state, then the right upper corner of the VFD display will show the word **OFF**. Press the key **On/Off** to change the input state into **ON** state. Then the right upper corner of the VFD display will show the word **CV_UN** or **Unreg**. Showing **CV_UN** means the load has been successfully set into the expected constant voltage value; showing **Unreg** means the load couldn't adjust itself to the expected constant voltage value. Please check if the measured power supplier has been correctly connected and turned on; make sure if the voltage is normal and if the maximum output current of the measured power supplier is in the range of the maximum current that the load can absorb.

In loading and unloading constant voltage mode, press the key **Shift+1(V_Level)**, the load will back into the standard constant voltage mode.

4.1.3.3 Soft Start Constant Voltage Mode

Soft start constant voltage mode functions as a condensive load, simulating electric capacity which is in direct proportion with the rise time of soft start. In this mode, the measured power supplier can be avoided from current strike damage.



Picture 4.8 Soft Start Constant Voltage Mode

When in standard constant voltage mode, press the key **Shift+2(S_Start)** to enter into the soft start constant voltage mode. When the VFD display shows **RISING TM=xxxxxxxvms** indicating the current rising time, press the numeric keys and decimal point key to enter the rising time required, followed by pressing the key **Enter**. In this way, the load will enter into the soft start constant voltage mode.

If the input state is in **OFF** state, then the right upper corner of the VFD display will show the word **OFF**. Press the key **On/Off** to change the input state into **ON** state. Then the right upper corner of the VFD display will show the word **CV_S** or **Unreg**. Showing **CV_S** means the load has been successfully set into the expected constant voltage value; showing **Unreg** means the load couldn't adjust itself to the expected constant voltage value. Please check if the measured power supplier has been correctly connected and turned on; make sure if the maximum output current of the measured power supplier is in the range of the maximum current that the load can absorb.

In loading and unloading constant voltage mode, press the key **Shift+2(S_Start)**, the load will back into the standard constant voltage mode.

Note: The rise time which is set is automatically regulated to be the round number times of 20uS.

4.1.4 Constant Power Operation Mode(CW)

In this mode, the electronic loads will consume a constant power. Please refer to the picture 4.9. If the load input voltage value increase, the load input current will decrease. Therefore the load power(=V * I)will remain in the power set.

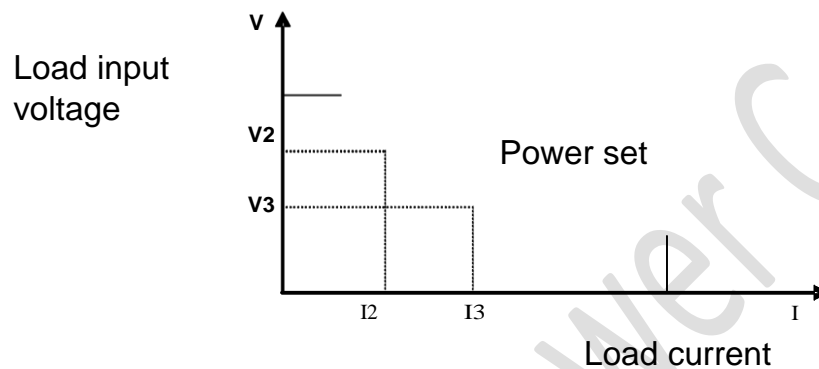

Picture 4.9 Constant Power Mode

4.1.4.1 Setting up a Standard Constant Power Mode

Press the key **P-SET**, then the VFD display will show **STANDARD POWER=xxxxxxxW** indicating the current constant power. Then Press the numeric keys and decimal point key to enter the constant power value required, followed by pressing the key **Enter**. In this way, the load will enter into the standard constant power mode.

If the input state is in **OFF** state, then the right upper corner of the VFD display will show the word **OFF**. Press the key **On/Off** to change the input state into **ON** state. Then the right upper corner of the VFD display will show the word **CW** or **Unreg**. Showing **CW** means the load has been successfully set into the expected constant power value; showing **Unreg** means the load couldn't adjust itself to the expected constant power value. Please check if the measured power supplier has been correctly connected and turned on; make sure if the voltage of the power supplier is normal and the maximum output current of the measured power supplier is undercurrent.

If you want to fine tune the constant power value, you can rotate the **selective encoder** knob to adjust the value. Rotating clockwise is to increase the value while rotating anti-clockwise is to decrease the value. Then the right lower corner of the VFD display shows the constant power value you set, among which, a cursor shows under one number, meaning this number requires fine tuning. If users want to change the fine tuning accuracy, just press the rotary encoder knob in which a key is included. Every time when you press the rotary encoder once, the cursor will move forward to the previous number.

4.1.4.2 Loading and Unloading Constant Power Mode

As for the loading and unloading mode theory, please refer to the 3.1.1.2 illustration.

When in standard constant power mode, press the key **Shift+1(V_Level)** to enter into the constant loading and unloading constant power mode. When the VFD display shows **ONSET VOLT=xxxxxxxV** indicating the current loading voltage, press the numeric keys and decimal point key to enter the loading voltage value required followed by pressing the key **Enter** to confirm. Then the VFD will show **OFFSET VOLT=xxxxxxxV** indicating the current unloading voltage. Press the numeric keys and decimal point key to enter the unloading voltage value required, followed by pressing the key **Enter** to confirm. In this way, the load will enter into the loading and unloading constant power mode.

If the input state is in **OFF** state, then the right upper corner of the VFD display will show the word **OFF**. Press the key **On/Off** to change the input state into **ON** state. Then the right upper corner of the VFD display will show the word **CW_UN** or **Unreg**. Showing **CW_UN** means the load has been successfully set into the expected constant power value; showing **Unreg** means the load couldn't adjust itself to the expected constant power value. Please check if the measured power supplier has been correctly connected and turned on; make sure if the voltage is normal and if the output current of the measured power supplier is in the range of the current that the expected power can absorb.

In loading and unloading constant power mode, press the key **Shift+1(V_Level)**, the load will back into the standard constant power mode.

4.2 Dynamic Testing Operation

Dynamic testing operation enables the electronic load to periodically switch between two load levels. This function can be used to test the transient characteristics of the measured power supplier.

Dynamic testing operation can be turned on and off by pressing the key **Shift** + **Tran** at the front panel. Before you turn on dynamic testing operation, you should set all of the parameters associated with dynamic testing operation by pressing the key **Shift** + **S-Tran**, including: Value A, A pulse time, Rising time from value A to value B, Value B, B pulse time, Falling time from value B to value A and dynamic testing operation mode. There are three kinds of dynamic testing operation mode: continuous mode, pulse mode and trigger mode.

4.2.1 Continuous Mode(CONTINUOUS)

In this mode, the electronic load will periodically switch between value A and value B when the dynamic testing operation is turned on.

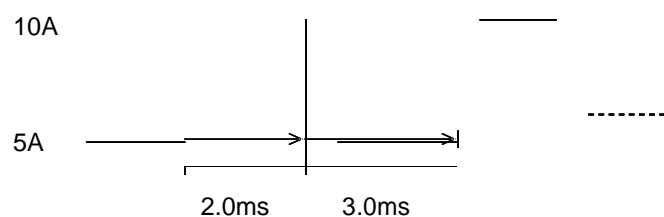

Picture 4.10 Continuous Operation Mode

4.2.2 Pulse Mode(PULSE)

In this mode, when the dynamic testing operation is turned on, the electronic load will switch to value B as receiving one trigger signal, taking the pulse time(TWD) of value B, Load will return to Value A.

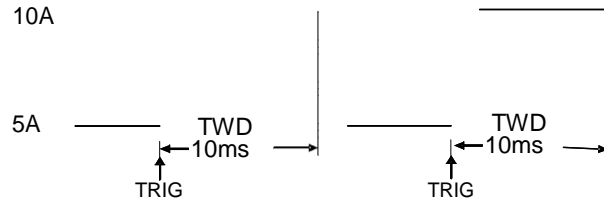

Picture 4.11 Pulse Operation Mode

4.2.3 Trigger Mode(TRIGGER)

In this mode, when the dynamic testing operation is turned on, the electronic load will switch the state between value A and value B once receiving a triggering signal.



Picture 4.12 Trigger Operation Mode

4.2.4 Setting up Dynamic testing operation Parameters

Press the key **Shift+6(S_Tran)**, then the load VFD display shows **LEVEL A CURR=xxxxxxxA** indicating the current value A set. Press the numeric keys and decimal point key to enter the current value required, followed by pressing the key **Enter** to confirm.

Then the load VFD display shows **WIDTH A TM=xxxxxxxmS** indicating the current lasting time of current value A set. Press the numeric keys and decimal point key to enter the lasting time required, followed by pressing the key **Enter** to confirm.

Then the load VFD display shows **RISING TM=xxxxxxxmS** indicating the current rising time set from value A to value B. Press the numeric keys and decimal point key to enter the rising time required, followed by pressing the key **Enter** to confirm.

Then the load VFD display shows **LEVEL B CURR=xxxxxxxA** indicating the current value B set. Press the numeric keys and decimal point key to enter the current value required, followed by pressing the key **Enter** to confirm.

Then the load VFD display shows **WIDTH B TM=xxxxxxxmS** indicating the current lasting time of current value B set. Press the numeric keys and decimal point key to enter the lasting time required, followed by pressing the key **Enter** to confirm.

Then the load VFD display shows **FALLING TM=xxxxxxxxmS** indicating the current falling time set from value B to value A. Press the numeric keys and decimal point key to enter the falling time required, followed by pressing the key **Enter** to confirm.

Then the load VFD display shows **TRANMODE CONTINUOUS/ TRANMODE PULSE / TRNMODE TRIGGER indicating** the current dynamic testing operation mode. Press the key ▲ or ▼ to choose the dynamic testing operation mode you want, followed by pressing the key **Enter** to confirm.

4.2.5 Waveform Control

4.2.5.1 Square Wave

When the rise time and falling time are both set as zero and the dynamic testing operation mode is set as continuous mode, the output wave is square wave. The output frequency is the inverse of the lasting time sum of current A and current B. Since the minimum accuracy of all the time is set as 20uS , the load can read the square wave with the maximum frequency of 25KHz and duty cycle of 50%.

4.2.5.2 Triangular Wave

When the lasting time of both current A and current B are set as zero and the dynamic testing operation mode is continuous mode, the output wave is triangular wave. The output frequency is the inverse of the sum of the rising time and falling time. Since the minimum accuracy of all the time is set as 20uS, the load can read the triangular wave with the maximum frequency of 25KHz. Since the rising edge and falling edge of the triangular wave are all step wave with 20uS output frequency, the ideal degree of triangular wave is in inverse proportion to the its output frequency. In extreme situations, the triangular wave might function as square wave; there are 0-100 accuracy difference according to the different rising time and falling time set.

4.2.5.3 Trapezoidal Wave

When the four time parameters that need to set are all bigger than zero and the dynamic testing operation mode is continuous mode, the load output wave is trapezoidal wave. It has the same frequency characteristics with the triangular wave.

4.2.6 Trigger Control

When dynamic testing operation mode is set as pulse mode or trigger mode, the trigger control is initiated. There are three trigger modes:

- a、 Keypad triggering mode

Press the key **Shift+Trigger** to p trigger the electronic load.

- b、 TTL triggering mode

Send a high pulse with a constant time more than 5m Sec to the trigger-In terminals in rear panel to trigger the electronic load.

- c、 PC control software triggering mode

4.2.7 List Function

The electronic load is available of list operation function. 8 sets of data can be edited at most and 200 steps can be edited in each set of data. Users can edit the duration of each step, the minimum time of each set of data. Please note that the minimum time should be the round numbers of 0.02mS and ranges from 0.02mS to 1310.7mS. The duration of each step has something to do with the minimum time you set.

If the minimum time is set as 0.02mS , then the duration of each step ranges from 0.02mS to 1310.7mS; if

the minimum time is set as 2mS , then the duration of each step ranges from 2mS to 131070mS.

4.2.7.1. List Operation

1) Press the key **Shift+0** to enter into the menu operation, and then press the ▲ and ▼ keys to get the item **MENU LIST**, followed by pressing the **Enter** key to confirm. Then press the ▲ and ▼ keys to get the item **EDIT LIST**, followed by pressing the **Enter** key to confirm. Then press the ▲ and ▼ keys to select the sequential code that need to be set, followed by pressing the **Enter** key to confirm.

2)When the VFD display shows **MINIMUM TM= xxxxxx mS** indicating the minimum time that requires to be set. Since this value affects the fine tuning and operable length of all kinds of waveforms, please carefully select the suitable parameters. Then press the key **Enter** to confirm. The electronic load will go into the following three output modes: **LIST CONTINOUS**, **LIST END HOLD**, and **LIST END RESET**. Press the ▲ and ▼ keys to select one output mode you wanted, followed by pressing the key **Enter** to confirm.

LIST CONTINOUS means continuous output mode.

LIST END HOLD means the electronic load will remain the last value you set in the last step when all the steps you set in one set of data have been successfully executed.

LIST END RESET means the electronic load will reset to be load off mode when all the steps you set in one set of data have been successfully executed.

3)After pressing the key **Enter** to confirm, the VFD display will show **STEP LENG= xxx**, indicating the step length that requires to be set. Then press the numeric keys to input the step length you want to set, followed by pressing the key **Enter** to confirm. Please note that the step length should be the round number of 1~200.

4)When the VFD display shows **STEP 1 CURR=xxxxxA**, indicating the current that requires to be set in the first step, press the numeric keys to input the current you want to set in the first step, followed by pressing the key **Enter** to confirm. When the VFD display shows **STEP 1 TM=xxxxx mS**, indicating the current duration in the first step, press the numeric keys to input the current duration you want to set in the first step, followed by pressing the key **Enter** to confirm.

5)If all the steps set have been edited, the VFD display will show **EDIT LIST** ,meaning exit back to the list function. If all the steps set have not been edited, the VFD display will show **STEP n CURR=xxxxxA**, indicating that data of the N step is being edited. Please finish it according to the operation instruction in last step, step 4).

6)Since list function shares the same storage space with automatic testing function; please make sure that the sequential code that you selected in the list function is the same with that in automatic testing function. If the sequential code which was defined as automatic testing function before, now is defined as list function, the automatic testing function of this sequential code will be deleted and cannot be restored.

4.2.7.2 Executing List Function

Press the key **Shift+0** to enter into menu configuration, and then press the ▲ and ▼ keys to get the item **MENU LIS**, followed by pressing the key **Enter** to confirm. Then press the ▲ and ▼ keys to

get the item **LOAD LIST**, followed by pressing the **Enter** key to confirm. Then press the **▲** and **▼** keys to select the sequential code defined as list function you want to execute, followed by pressing the **Enter** key to confirm

Since the list function shares the same storage space with automatic testing function, those sequential code defined as the automatic testing function will be automatically shielded when choosing the sequential codes which are defined as list function.

4.2.8 Automatic Testing Function

The electronic load is available of automatic testing function. 8 sets of data can be edited at most and 50 steps can be edited in each set of data. Each step can be edited as the following six working mode: load off mode, constant current mode, constant voltage mode, constant power mode, constant resistance mode, short circuit mode, and can be edited as the following four types: current comparison, voltage comparison, power comparison and resistance comparison. Besides, the delay time of each step can also be edited. The delay time of each step ranges from 0.1~25.5S, considering the quickness and accuracy. When automatic test is over, the electronic load will indicate if it passes the test or failed. If it fails, the electronic load will sound alarm. Meanwhile, the electronic load can be triggered by front-panel and TRIGGE IN hardware voltage level in the back-panel, and can output the trigger voltage level from the TRIGGER OUT terminals on back panel. You can setup it as the voltage level trigger mode or pulse trigger mode, and can have 4 selections of Pass trigger, failure trigger, finish trigger and disabled trigger.

4.2.8.1 Automatic Test Operation

1) Press the key **Shift+0** to enter into the menu configuration, and then press the **▲** and **▼** keys to get the item **MENU AUTO TEST**, followed by pressing the **Enter** key to confirm. Then press the **▲** and **▼** keys to get the item **EDIT AUTO TEST**, followed by pressing the **Enter** key to confirm. Then press the **▲** and **▼** keys to select the sequential code that need to be set, followed by pressing the **Enter** key to confirm.

2) When the VFD display shows **STEP LENG= XX**, indicating the step length that requires to be set. Then press the numeric keys to input the step length you want to set, followed by pressing the key **Enter** to confirm. Please note that the step length should be the round numbers of 1~50.

3) When the VFD display shows **STEP 1 xxxxx MODE**, indicating the working mode selected in the step 1, press the **▲** and **▼** keys to select one mode from the following six working modes, followed by pressing the key **Enter** to confirm.

Working Mode	Prompting Messenges	Explanation
Load Off Mode	LOAD OFF MODE"	Compare the voltages when in load off mode
CC Mode	"CC MODE"	Choose one of four types: current comparison, voltage comparison, power comparison and resistance comparison.
CV Mode	"CV MODE"	Choose one of four types: current comparison, voltage comparison, power comparison and resistance comparison.
CP Mode	"CP MODE"	Choose one of four types: current comparison, voltage comparison, power comparison and

		resistance comparison.
CR Mode	“CR MODE”	Choose one of four types: current comparison, voltage comparison, power comparison and resistance comparison.
Short Circuit Mode	“SHORT MODE”	Compare the current when in short circuit mode

4)When the VFD display shows **STEP 1 TEST xxxx**, indicating the test types. There are four test types: test current, test voltage, test power, test resistance. Press the ▲ and ▼ keys to select one from those four types, followed by pressing the key **Enter** to confirm. If in last step, step 3), you choose load off mode or short circuit mode, then the electronic load will skip step 4).

5)When the VFD display shows **DELAY TM=xx.xS** , indicating the delay time of each step. The valid range of the delay time is 0.1~25.5S. The lower value you set, the shorter time the test needs. But in certain circumstances, too lower value may affect the test results because the test has been finished before the power supply reaches static state, so please carefully select the delay time you wanted to set. The recommended delay time is 0.5S. Note: 25.5S is set as suspended mode. So the delay time of a certain step is set as 25.5S, the load will stop to be proceeded to the next step until a trigger is input. The trigger can be made either by the hardware in the back-panel, or by pressing the key **Shift+Trigger** or the **On/Off** key in the front panel.

6)When the VFD display shows **INPUT xxxx=xxxxxx**, indicating the corresponding current value set/voltage value set/ power value set/ resistance value set in working mode. Press the numeric keys to enter the value, followed by pressing the key **Enter** to confirm. If in step 3), you choose load off mode or short circuit mode, then the electronic load will skip step 6).

7)When the VFD display shows **MINIMUM xxxx=xxxxxx**, indicating the lower limit of valid comparison, press numeric keys to input the value, followed by pressing the key **Enter** to confirm. When the VFD display shows **MAXIMUM xxxx=xxxxxx**, indicating the upper limit of valid comparison, press numeric keys to input the value, followed by pressing the key **Enter** to confirm.

If all the steps set have been edited, the VFD display will show **EDIT AUTO TEST** , meaning exit back to the automatic testing function. If all the steps set have not been edited, the VFD display will show **STEP n xxxxx MODE**, indicating that data of the N step is being edited.

4.2.8.2 Setting up Automatic Test Trigger Output Mode

Press the key **Shift+0** to enter into the menu configuration, and then press the ▲ and ▼ keys to get the item **MENU AUTO TEST**, followed by pressing the **Enter** key to confirm. Then press the ▲ and ▼ keys to get the item **SETUP AUTO TEST**, followed by pressing the **Enter** key to confirm. The load will enter into the automatic test trigger output mode.

There are the following 4 types of trigger output modes. Please press the ▲ and ▼ keys to select one you wanted, followed by pressing the key **Enter** to confirm.

Prompting Messenges	Explanation
“TRIGGER WHEN PASS”	Trigger once when pass the test
“TRIGGER WHEN FAIL”	Trigger once when failing the test
“TRIGGER WHEN TEST END”	Trigger once when finishing the test
“TRIGGER DISABLE”	Trigger disabled

Meanwhile, the Load will display the following trigger output electrical feature

Display	Description
“OUTPUT LEVEL”	When there is a trigger output, the voltage level will change from low to high, till a key pressed or a trigger input signal arrive, the voltage level will sink to low status.
“OUTPUT PLUSE”	When there is trigger output, the voltage level change from low to high status, 5 seconds later, it will sink to low automatically.

4.2.8.3 Executing Automatic Test Function

Press the key **Shift+0** to enter into the menu configuration, and then press the ▲ and ▼ keys to get the item **MENU AUTO TEST**, followed by pressing the **Enter** key to confirm. Then press the ▲ and ▼ keys to get the item **LOAD AUTO TEST**, followed by pressing the **Enter** key to confirm. Then press the ▲ and ▼ keys to select the sequential code defined as the automatic test function you want to execute, followed by pressing the **Enter** key to confirm. Then the upper right corner of the VFD display shows **AUT n**, meaning the **n** automatic test list will be initiated. The bottom right of the VFD

If users have prepared all things well, press the key **On/Off** to initiate the automatic test. The automatic test can also be initiated by lowering the voltage level of **TRIG IN** port and lasting more than 5mS. When in testing, the right lower corner of the VFD display will show **WAIT** or **STAY**, meaning waiting for testing or staying in the suspended mode respectively. Please retrigger it so that it goes on testing.

After testing, the right lower corner of the VFD display will show either **PASS** or **FAIL**. When failure, the buzzer will sound. At this moment, initiate next trigger or press any key to free from the indication of pass or fail.

When once automatic test is finished, users can press the ▲ and ▼ keys to initiate manually operated test mode. Every time press the key ▲ or the key ▼ once, the load will begin to the carrying test of the last step or the next step. Users can observe the actual state of every step. When the key ON/OFF is pressed or a trigger is input, the electronic load will automatically exit from the manually operated test mode and start to automatic test again.

4.3 Input Control

4.3.1 Short Circuit Operation(SHORT)

Load can simulate a short circuit at the input end by turning the load on with full-scale current. The short circuit can be toggled on/off at the front panel by pressing the **key Shift+9(Short)**. Short circuit operation does not influence the current value set. When short circuit operation is on **OFF** state, the Load will back to the original setting state.

The actual current value that the load consumes in short circuit condition is dependent on the working mode and current range of the load that are active. In CC, CW and CR mode, the maximum short-circuit current value is 1.2 times of the current range. In CV mode, short-circuit operation is same as the operation of setting constant voltage to 0V.

4.3.2 Input On/Off Operation

When the load input state is in **ON** state, you can press the key **On/Off** to change the input state into **OFF** state. Then the right upper corner of the VFD display shows **OFF**. When the load input state is in **OFF**

state, you can press the key **On/Off** to change the input state into **ON** state. Then the right upper corner of the VFD display shows **ON** indicating the current working state.

4.4 Electronic Load Operation Range

Electronic load works in the range of Rated Current, Rated voltage and Rated Power. Please refer to the picture 4-13 and picture 4-14.

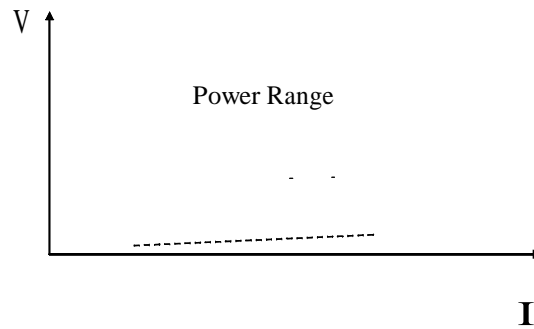

Picture 4-13 Electronic Load Power Range

Electronic load Mode Change

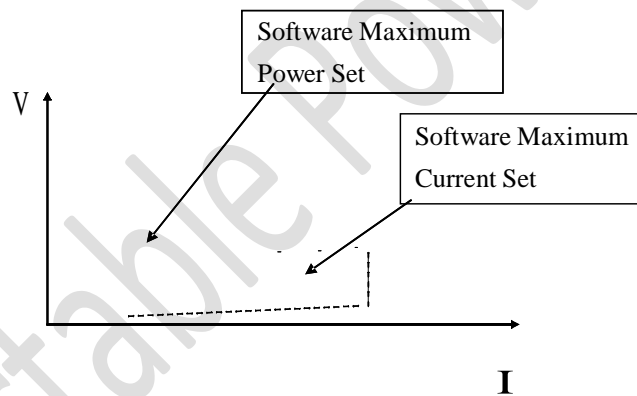

Picture 4-14 Software Maximum Setting Value

4.5 Protection Functions

Electronic load includes the following protection functions.

4.5.1 Over Voltage Protection(OV)

If input voltage exceeds the voltage limit, load will turn off the input. Buzzer will sound and the VFD display shows **Over Volt**.

The load maximum voltage value can be set by pressing the key **Shift+0(Menu)**. When the VFD display shows **MENU SYSTEM SET**, press the key **Enter** to confirm. Then the VFD display shows **SYSTEM IMAX=xxxxxxx A**. Press the **Up** and **Down** keys to make adjustment until the VFD display shows **SYSTEM UMAX=xxxxxxx V** indicating the current maximum voltage value, then enter the maximum voltage value required by pressing the numeric keys and decimal point key, followed by pressing the key **Enter** to confirm. Then press the key **Esc** to escape the **Menu** item.

Note: The maximum voltage value of M9711 electronic load is 150V. When it is beyond 150V, it will be automatically adjusted to 150V.

Besides, the maximum voltage value has close relation with the voltage resolution. If the maximum voltage value is below 20V, the load voltage resolution will be 0.1mV; if the maximum voltage value is beyond 20V, then the load voltage resolution will be only 1mV.

4.5.2 Over Current Protection(OC)

When input current exceeds the current limit, Buzzer will sound and VFD display will shows **OVER CUR.**

The load maximum voltage value can be set by pressing the key **Shift+0(Menu)**. When the VFD display shows **MENU SYSTEM SET**, press the key **Enter** to confirm. Then the VFD display shows **SYSTEM IMAX=xxxxxxxA** indicating the current maximum current value. Press the numeric keys and decimal point key to enter the maximum current value required, followed by pressing the key **Enter** to confirm. Then press the key **Esc** to escape the **Menu** item.

Note: The maximum current value of M9711 electronic load is 30A. When it is beyond 30A, it will be automatically adjusted to 30A.

Besides, the maximum current value has close relation with the current resolution. If the maximum current value is or is below 3A, the load current resolution will be 0.01mA; If the maximum current value is beyond 3A, then the load current resolution will be only 0.1mA.

4.5.3 Over Power Protection(OW)

When input power exceeds the power limit, buzzer will sound and VFD display will show **OVER POW.** Users need to press any key to get the load work normally. Note: if the current input state is in **OFF** state, you need to press the key **ON/OFF** to make the load work normally. If the over power problem is not solved, the load will shows **OVER POW** again.

The load maximum power value can be set by pressing the key **Shift+0(Menu)**. When the VFD display shows **MENU SYSTEM SET**, press the key **Enter** to confirm. Then the VFD display shows **SYSTEM IMAX=xxxxxxxA**. Press the **Up** and **Down** keys to make adjustment until the VFD display shows **SYSTEM PMAX=xxxxxxxW** indicating the current maximum power value, then enter the maximum power value required by pressing the numeric keys and decimal point key, followed by pressing the key **Enter** to confirm. Then press the key **Esc** to escape the **Menu** item.

Note: The maximum power value of M9711 electronic load is 300W. When it is beyond 300W , it will be automatically adjusted to 300W.

4.5.4 Input Polarity Reversed

When the electronic load is in input polarity reversed state, the buzzer will sound and the VFD display will show **REVERSE.**

4.5.5 Over Heat Protection(OH)

If internal power component's temperature exceeds 80°C, over height protection will be initiated automatically. Load will turn off the input and Buzzer will sound and VFD display will show **OVERHEAT**.

4.6 Remote Measurement Function

When in CV, CR and CP mode, if load consumes high current, the power supplier will produce voltage drop in the connecting wire between measured power supplier and load terminals. In order to guarantee the measurement accuracy, remote measurement terminals is installed at the rear-panel of the electronic load. Users can measure the output terminals voltage of measured power supplier by these terminals.

The remote measurement function can be set by pressing the key **Shift+0(Menu)**. When the VFD display shows **MENU SYSTEM SET**, press the key **Enter** to confirm. Then the VFD display shows **SYSTEM IMAX=xxxxxxxA**. Press the **Up** and **Down** keys to make adjustment until the VFD display shows **SYSTEM TERMINAL SEL** indicating to set the parameters of the current remote measurement function, then press the key **Enter** to confirm. When the VFD display shows **TERMINAL SELECT FRONT** or **TERMINAL SELECT BACK**, press the **Up** and **Down** keys to select the parameters of remote measurement function. Showing **TERMINAL SELECT FRONT** means input terminals selected is at the front panel and the remote measurement function of the rear panel is closed; showing **TERMINAL SELECT BACK** means input terminals selected is at the rear panel and the remote measurement function of the front panel is closed. Then press the key **Esc** to escape the **Menu** item.

Note: At any time either the input terminals at the front panel or at the back panel is initiated. It is impossible to initiate the input terminals both at the front panel and at the back panel together. If the voltage of the load is near to zero point and does not change according to the signal, please check if the wire mode matches the parameters of the remote measurement function.

4.7 Battery Testing

Experiment proves the test with load is the best method to ensure the battery whether work well or not. Only with the correct load testing, the battery can be confirmed if it was being the expectant life curve location. The M9711 electronic loads can be used to test any type of the battery nowadays.

As to any battery used either in sheltered equipment or in the uninterrupted service system, it is necessary to use the load testing. Because the battery is the lowest reliable component, it must be tested by the load periodically to ensure the reliability of the battery.

Capability Test

Constant current mode is applied in M9711 Serial electronic load to test the capability. A program is set to control voltage level. When the voltage of the battery is too low, the electronic load will identify the battery being on the threshold value set or at the margin of insecure state and will stop testing automatically. When the load is in testing procedure, you can see the battery voltage, battery discharge

current, electronic, load power and battery capability that has been spared. If the load is connected with PC software, then you can see the discharge curve of battery discharge. This test can test out the reliability and remaining life of battery. So it is very necessary to do the test before you change another new battery.

Operation:

- 1) In standard constant current mode, adjust the load current value to the discharge current value of battery required.
- 2) Press the key **Shift+8(Battery)**. When VFD display shows **END TEST VOLT= xxxxxxxxV** , set the turn-off voltage and press the key **Enter** to start the capability test. When the voltage drops to the turn-off voltage, the load will automatically turn off.
- 3) Press the key **On/Off** to start or to pause the battery capability test.
- 4) Press the key **Shift+8(Battery)**to escape the battery capability test mode.

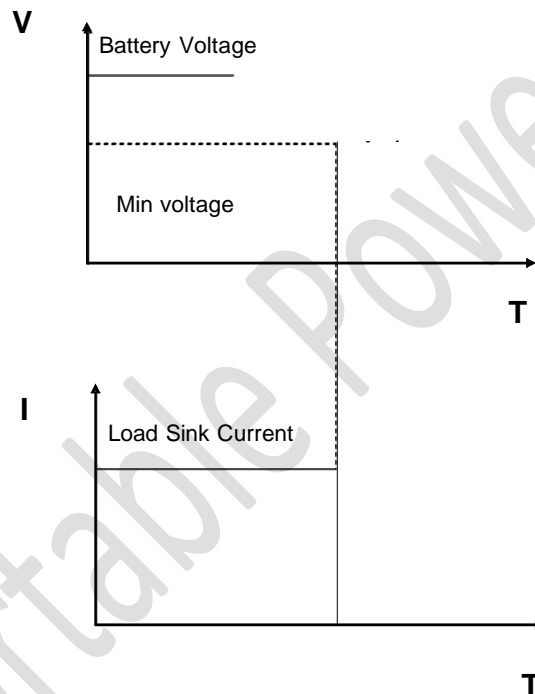

Picture 4-16 Battery Capability Schema

4.8 Communication protocol

4.8.1 Introduction

M97 series programmable electronic loads work with Modbus protocol. The data frame contains 4 parts as follows:

Salve Address	Function Code	Data	Error Checking(CRC)
---------------	---------------	------	---------------------

To make sure high reliability for the communication, we need to set the frame pitch greater than 3.5 times of the transient time of single bit byte. Eg. When the baud rate is 9600, then the frame pitch time must be greater than $11 \times 3.5 / 9600 = 0.004s$.

M97 series programmable electronic loads provided with double way asynchronous communication, fixed 1 bit as the start bit, 8 data bit, and 1 stop bit. Support Non parity check, Odd Parity check and even parity check. Baudrate could be selected as 2400, 9600, 14400, 28800, 57600, 115200.

1) Setup additional address and communication parameter

The additional address is a single byte with 16 hexadecimal system data; M97 series electronic loads will only response the request data frame which has the same additional address.

2) Setup the additional address

Press **Shift+0** in turn, Enter into the Main Menu, the Load will display as **MENU CONFIG**, Press the key **Enter** to confirm, then the load get into **CONFIG Menu**, press **▲** and **▼** key button, to let the load display **CONFIG ADDRESS SET**, then press Enter to confirm, the load will display **ADDRESS ADDR= xxx**, you can change the address number by press the numeric keys, and press the key **Enter** again to confirm.

Note: The valid additional address number is integers in the range of 1-200.

3) Select the check mode

Press **Shift+0** in turn, enter into the main Menu, the load will display **MENU CONFIG**, press the key **Enter** to confirm, the load will get into **CONFIG menu**, press **▲** and **▼** key button, to let the load display **CONFIG COMM.PARITY**, press **Enter** to confirm, then the load will display **COMM.PAR xxxxx**, you can select the parity check mode by pressing **▲** and **▼** key button, and then press **Enter** to confirm.

4.8.3 Communication interface DB9 and its pin's define

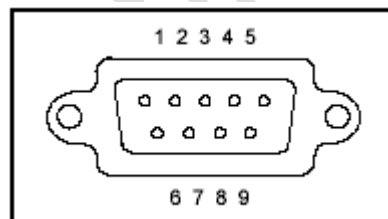

- 1 +5V
- 2 TXD
- 3 RXD
- 4 NC
- 5 GND
- 6 NC
- 7 NC
- 8 NC

4.8.2 Setup Baudrate

Press **Shift+0** in turn , the load will display **MENU CONFIG**, Press Enter to confirm, the load will enter into **CONFIG menu**, press **▲** and **▼** key button to let the load display **CONFIG BAUDRATE SET**, press Enter to confirm, the load will display **BUADRATE xxxxx**, you can choose the appropriate baudrate as you need, and press Enter to confirm. Totally 6 different baudrate provided for selection. 2400、9600、14400、28800、57600、115200.

4.8.3 Data

In some data frame, the date length is fixed, but there are some data frame length is not fixed. According to Modbus protocol, in the data field, all the hex data and floating point number are formed as the High Byte in the former and Low byte in the after. Addition,the output value of force single coil must be 0x0000 or 0xFF00. 0x0000 means OFF, while 0xFF00 means ON. All other values are invalid and will not affect the coil.

4.8.4 Function Code

Function codes are single byte hex number; there are 4 function modes as follows:

Function Code	Description
0x01	Read Coil Status, read the data by the bit
0x05	Force Single Coil, write the data by the bit
0x03	Read Holding Registers, read the data by the word
0x10	Preset Multiple Registers, write the data by the word

4.8.5 Error checking(CRC)

M97 series load use the Cyclic Redundancy Check (CRC). The CRC field checks the contents of the entire message. The CRC field is two bytes, containing a 16-bit binary value. When the CRC is appended to the message, the low-order byte is appended first, followed by the high-order byte.

The discipline is as follows:

- Setup one hex CRC register, and give the initial value as 0xFFFF.
- Make bitxor for the first byte of the frame data and the lower 8 bit of the CRC register. And save the bitxor result into the CRC register.
- Right move CRC register for 1 byte, and check the if the lowest bit is 1, if the lowest bit is 1, and then make the bitxor for the CRC register and the fixed data 0xA001.
- Repeat c) for 8 times.
- Repeat step b,c,d, for the next byte of frame data, till the last byte.
- The last number in the CRC register is the last parity checking result. Put it at the end of the frame data, and keep the lower 8 bit in the after and higher 8 bit in former.

4.8.6 Complete Command Frame Analysis

1. Read Coil Status (0x01)

Read Coil Status Example Query

Field Name	Byte length	Example Value
Slave Address	1	1~200
Function Code	1	0x01
Starting Address	2	0~0xFFFF
NO. of Points	2	1~16
CRC Error Check	2	

Read Coil Status Example Normal Response

Field Name	Byte length	Example Value
Slave Address	1	1~200
Function Code	1	0x01
Byte Count	1	1~2
Data(Coil Status)	n	
CRC Error Check	2	

Read Coil Status Example Abnormal Response

Field Name	Byte length	Example Value
Slave Address	1	1~200
Function Code	1	0x81
Abnormal Code	1	01~04
CRC Error Check	2	

For example :

The following example reads the load input state (ISTATE) of Coil at slave device address 0x01. From table 4.8.7.1, we know that the ISTATE address is 0x0510.

Query: 0x01 0x01 0x05 0x10 0x00 0x01 0xFC 0xC3

The Corresponding Normal Response: 0x01 0x01 0x01 0x48 0x51 0xBE, among which, 0x48 is the read-back data and its lowest bit is 0, this means the input state ISTATE is OFF.

2. Force Single Coil (0x05)

Force Single Coil Example Query

Field Name	Byte length	Example Value
Slave Address	1	1~200
Function Code	1	0x05
Coil Address	2	0~0xFFFF
Force Data (Coil Status)	2	0x0000 or 0xFF00
CRC Error Check	2	

Force Single Coil Example Normal Response

Field Name	Byte length	Example Value
Slave Address	1	1~200
Function Code	1	0x01
Coil Address	2	0~0xFFFF
Force Data (Coil Status)	2	0x0000 or 0xFF00
CRC Error Check	2	

Force Single Coil Example Abnormal Response

Field Name	Byte length	Example Value
Slave Address	1	1~200
Function Code	1	0x85
Abnormal Code	1	01~04
CRC Error Check	2	

A value of 0xFF00 forces the coil to be ON, and 0x0000 forces the coil to be turned OFF. All other values are invalid and will not affect the coil.

For example :

The following example sets the load is in remote control at slave device address 0x01.

From table 4.8.7.1, we know that the PC1 remote address is 0x0510.

Query: 0x01 0x05 0x05 0x00 0xFF 0x00 0x8C 0xF6

The Corresponding Response: 0x01 0x05 0x05 0x00 0xFF 0x00 0x8C 0xF6

3. Read Holding Registers (0x03)

Read Holding Registers Example Query

Field Name	Byte length	Example Value
Slave Address	1	1~200
Function Code	1	0x03
Starting Address	2	0~0xFFFF
No. of Points	2	n=1~32
CRC Error Check	2	

Read Holding Registers Example Normal Response

Field Name	Byte length	Example Value
Slave Address	1	1~200
Function Code	1	0x03
Byte Count	1	2*n
Data	2*n	
CRC Error Check	2	

Read Holding Registers Example Abnormal Response

Field Name	Byte length	Example Value
Slave Address	1	1~200
Function Code	1	0x83
Abnormal Code	1	01~04
CRC Error Check	2	

For example :

The following example reads the present voltage value at slave device address 0x01.

From table 4.8.7.1, we know that the register address of the present voltage value is 0x0B00,

Query: 0x01 0x03 0x0B 0x00 0x00 0x02 0xC6 0x2F

The Corresponding Normal Response: 0x01 0x03 0x04 0x41 0x20 0x00 0x2A 0x6E 0x1A, among which, 0x41 0x20 0x00 0x2A is the read-back voltage value, the corresponding floating point number is 10V.

4. Preset Multiple Registers (0x10)

Preset Multiple Registers Example Query

Field Name	Byte length	Example Value
Slave Address	1	1~200
Function Code	1	0x10
Starting Address	2	0~0xFFFF
No. of Registers	2	n=1~32
Byte count	1	2*n
Preset Data	2*n	
CRC Error Check	2	

Preset Multiple Registers Example Response

Field Name	Byte length	Example Value
Slave Address	1	1~200
Function Code	1	0x10
Starting Address	2	0~0xFFFF
No. of Registers	2	N
CRC Error Check	2	

Preset Multiple Registers Example Abnormal Response

Field Name	Byte length	Example Value
Slave Address	1	1~200
Function Code	1	0x90
Abnormal Code	1	01~04
CRC Error Check	2	

For example :

The following example sets the load's constant current IFIX is 2.3A at slave device address 0x01. From table 4.8.7.1, we know that the IFIX register address is 0x0A01, the floating point takes up two-word length.

Query: 0x01 0x10 0x0A 0x01 0x00 0x02 0x04 0x40 0x13 0x33 0x33 0xFC 0x23

The Corresponding Normal Response: 0x01 0x10 0x0A 0x01 0x00 0x02 0x13 0xD0

4.8.7 Coil With The Register Address Allocation

Table 1: Coil-bit definition:

Name	Address	Bit	Property	Description
PC1	0x0500	1	W/R	When remote control status bit is 1, front key panel unable
PC2	0x0501	1	W/R	When local prohibition bit is 1, not allow to use key "Shift +7" to snatch away the front panel control.
TRIG	0x0502	1	W/R	Trigger tagged: triggered once by software
REMOTE	0x0503	1	W/R	1: remote input voltage
ISTATE	0x0510	1	R	Input status: 1- input ON, 0- input OFF

TRACK	0x0511	1	R	Tracking status: 1-voltage tracking; 0-current tracking
MEMORY	0x0512	1	R	1:input state memory
VOICEEN	0x0513	1	R	1: key sound ON/OFF
CONNECT	0x0514	1	R	1: multi 0= single
ATEST	0x0515	1	R	1: Automatic test mode
ATESTUN	0x0516	1	R	1: Automatic test pattern waiting to trigger
ATESTPASS	0x0517	1	R	1: success automatic test success ,0: automatic test failed
IOVER	0x0520	1	R	1:over-current tag
UOVER	0x0521	1	R	1: over-voltage tag
POVER	0x0522	1	R	1: over- Power tag
HEAT	0x0523	1	R	1: over-heat tag
REVERSE	0x0524	1	R	1: reverse tag
UNREG	0x0525	1	R	1: register parameter failed tag
ERREP	0x0526	1	R	1: EPPROM error tag
ERRCAL	0x0527	1	R	1: calibration data error tag

Table 2: Register XRAM area definition

Name	Address	Bit	Property	Description
CMD	0x0A00	1	W/R	Command Register : lower 8 bits effective,high 8 bits meaningless
IFIX	0x0A01	2	W/R	Constant current register: double-type
UFIX	0x0A03	2	W/R	Constant voltage register, double-type
PFIX	0x0A05	2	W/R	Constant power register,double-type
RFIX	0x0A07	2	W/R	Constant resistance register: double-type
TMCCS	0x0A09	2	W/R	Current soft-start rising time register , double type
TMCVS	0x0A0B	2	W/R	Voltage soft-start rising time register , double type
UCCONSET	0x0A0D	2	W/R	Constant current load voltage register :double-type
UCCOFFSET	0x0A0F	2	W/R	constant current unload voltage register , double-type
UCVONSET	0x0A11	2	W/R	Constant voltage load voltage register :double-type
UCVOFFSET	0x0A13	2	W/R	Constant voltage unloaded voltage regi , double-type
UCPONSET	0x0A15	2	W/R	Constant power load voltage register , double-type
UCPOFFSET	0x0A17	2	W/R	Constant power unload voltage register , doubl-type
UCRONSET	0x0A19	2	W/R	Constant resistance load voltage register , double-type

UCROFFSET	0x0A1B	2	W/R	Constant resistance unload voltage register , double type
UCCCV	0x0A1D	2	W/R	constant current shift constant voltage register:double type
UCRCV	0x0A1F	2	W/R	Constant resistance shift constant voltage register, double type
IA	0x0A21	2	W/R	dynamic mode A phase current register, double-type
IB	0x0A23	2	W/R	dynamic mode B phase current register, double-type
TMAWD	0x0A25	2	W/R	dynamic mode A pulse-width registers, double-type
TMBWD	0x0A27	2	W/R	dynamic mode B pulse-width registers ,double-type
TMTRANRIS	0x0A29	2	W/R	Dynamic mode rising time register,r double-type
TMTRANFAL	0x0A2B	2	W/R	Dynamic model falling time register double-type
MODETRAN	0x0A2D	1	W/R	Dynamic mode register,u16-type
UBATTEND	0x0A2E	2	W/R	Battery Test termination voltage register ,double type
BATT	0x0A30	2	W/R	Battery capacity register, double –type
SERLIST	0x0A32	1	W/R	LIST serial number register, u16 type
SERATEST	0x0A33	1	W/R	Automatic Test serial number register , u16 type
IMAX	0x0A34	2	W/R	Current maximum register , double type
UMAX	0x0A36	2	W/R	Voltage maximum register , double type
PMAX	0x0A38	2	W/R	Power maximum register ,double type
ILCAL	0x0A3A	2	W/R	Calibration current low-end target value double type
IHCAL	0x0A3C	2	W/R	Current high-end calibration target value , double type
ULCAL	0x0A3E	2	W/R	Voltage low-end calibration target value , double type
UHCAL	0x0A40	2	W/R	Voltage high-end calibration target value , double type
TAGSCAL	0x0A42	1	W/R	Calibration state tag , u16 type
U	0x0B00	2	R	Voltage Register ,double type

I	0x0B02	2	R	Current Register ,double type
SETMODE	0x0B04	1	R	Operation Mode register,u16e type
INPUTMODE	0x0B05	1	R	Input Status Register , u16 type
MODEL	0x0B06	1	R	Model Register ,u16 type
EDITION	0x0B07	1	R	software version number register,u16 type

4.8.8 The Definition Of The Command Register CMD

Definition	CMD Value	Description
CC	1	
CV	2	
CW	3	
CR	4	
CC Soft Start	20	
Dynamic Mode	25	
Short Circuit Mode	26	
List Mode	27	
CC Loading And Unloading Mode	30	
CV Loading And Unloading Mode	31	
CW Loading And Unloading Mode	32	
CR Loading And Unloading Mode	33	
CC Mode Switch To CV Mode	34	
CR Mode Switch To CV Mode	36	
Battery Test Mode	38	
CV Soft Start	39	
Changin System Parameters	41	
Input ON	42	
Input OFF	43	

4.8.9 Common Operation Function Description

Table 1 Remote Control Operation :

Operation	Register	Value	Description
Force Single Coil	PC1	1	mandatory

Table 2 cancel remote control operation:

Operation	Register	Value	Description
Force Single Coil	PC1	0	mandatory

Table 3 Local Prohibition control operations:

Operation	Register	Value	Description
Force Single Coil	PC2	1	mandatory

Table 4 Local allows the operator to:

Operation	Register	Value	Description
-----------	----------	-------	-------------

Force Single Coil	PC2	0	mandatory
-------------------	-----	---	-----------

Table 5 Input ON operation:

Operation	Register	Value	Description
Preset Multi-Registers	CMD	42	mandatory

Table 6 Input OFF operation:

Operation	Register	Value	Description
Preset Multi-Registers	CMD	43	mandatory

Table 7 Short-circuit operation:

Operation	Register	Value	Description
Preset Multi-Registers	CMD	26	mandatory

Table 8 CC mode operation:

Operation	Register	Value	Description
Preset Multi-Registers	IFIX	Double	Optional
Preset Multi-Registers	CMD	1	mandatory

Table 9 CV mode operation:

Operation	Register	Value	Description
Preset Multi-Registers	UFIX	Double	Optional
Preset Multi-Registers	CMD	2	mandatory

Table 10 CW mode operation:

Operation	Register	Value	Description
Preset Multi-Registers	PFIX	Double	Optional
Preset Multi-Registers	CMD	3	mandatory

Table 11 CR mode operation:

Operation	Register	Value	Description
Preset Multi-Registers	RFIX	Double	Optional
Preset Multi-Registers	CMD	4	mandatory

Table 12 CC mode soft-start:

Operation	Register	Value	Description
Preset Multi-Registers	IFIX	Double	Optional
Preset Multi-Registers	TMCCS	Double	Optional
Preset Multi-Registers	CMD	20	mandatory

Table 13 CV mode soft-start:

Operation	Register	Value	Description
Preset Multi-Registers	UFIX	Double	Optional
Preset Multi-Registers	TMCVS	Double	Optional
Preset Multi-Registers	CMD	39	mandatory

Table 14 CC loading and unloading mode:

Operation	Register	Value	Description
Preset Multi-Registers	IFIX	Double	Optional
Preset Multi-Registers	UCCONSET	Double	Optional
Preset Multi-Registers	UCCOFFSET	Double	Optional
Preset Multi-Registers	CMD	30	mandatory

Table 15 CV loading and unloading mode:

Operation	Register	Value	Description
Preset Multi-Registers	UFIX	Double	Optional
Preset Multi-Registers	UCVONSET	Double	Optional
Preset Multi-Registers	UCVOFFSET	Double	Optional
Preset Multi-Registers	CMD	31	mandatory

Table 16 CW loading and unloading mode:

Operation	Register	Value	Description
Preset Multi-Registers	PFIX	Double	Optional
Preset Multi-Registers	UCPONSET	Double	Optional

Preset Multi-Registers	UCPOFFSET	Double	Optional
Preset Multi-Registers	CMD	32	mandatory

Table 17 CR loading and unloading mode:

Operation	Register	Value	Description
Preset Multi-Registers	RFIX	Double	Optional
Preset Multi-Registers	UCRONSET	Double	Optional
Preset Multi-Registers	UCROFFSET	Double	Optional
Preset Multi-Registers	CMD	33	mandatory

Table 18 CC mode switch to CV mode:

Operation	Register	Value	Description
Preset Multi-Registers	IFIX	Double	Optional
Preset Multi-Registers	UCCCV	Double	Optional
Preset Multi-Registers	CMD	34	mandatory

Table 19 CR mode switch to CR mode:

Operation	Register	Value	Description
Preset Multi-Registers	RFIX	Double	Optional
Preset Multi-Registers	UCRCV	Double	Optional
Preset Multi-Registers	CMD	35	Must select

Table 20 battery test mode:

Operation	Register	Value	Description
Preset Multi-Registers	IFIX	Double	Optional
Preset Multi-Registers	UBATTEND	Double	Optional
Preset Multi-Registers	CMD	38	mandatory

Table 21 Dynamic Test Mode :

Operation	Register	Value	Description
-----------	----------	-------	-------------

Preset Multi-Registers	IA	Double	Optional
Preset Multi-Registers	IB	Double	Optional
Preset Multi-Registers	TMAWD	Double	Optional
Preset Multi-Registers	TMBWD	Double	Optional
Preset Multi-Registers	TMTRANRIS	Double	Optional
Preset Multi-Registers	TMTRANFAL	Double	Optional
Preset Multi-Registers	MODETRAN	0~2	Optional
Preset Multi-Registers	CMD	25	mandatory

Table 22 System parameter setting mode :

Operation	Register	Value	Description
Preset Multi-Registers	IMAX	Double	Optional
Preset Multi-Registers	UMAX	Double	Optional
Preset Multi-Registers	PMAX	Double	Optional
Force Single Coil	REMOTE	0xFF00/0x0000	Optional
Preset Multi-Registers	CMD	41	mandatory

4.9 Remote operation

The DB9 interface connector on the rear panel of the power supplier can be transferred to RS232 interface through the voltage level shift cable (M-131 or M-133), the following information will tell you how to use the computer to control the output of the power supplier. Before carrying out the remote operation mode, please use the voltage level shift cable (M-131 or M-133) provided by our company, for M-131 or M-133 can not only transform TTL voltage level into RS232 signal, but also connect the DB9 interface connector with computer's serial interface.

4.9.1 M-131 or M-133 Communication Cable

The DB9 interface connector on the rear panel of electronic load is TTL voltage level; you can use the communication cable (M-131 or M-133) to connect the DB9 interface connector of the electronic load and the RS-232 interface connector of computer for the communication. Please refer to the following picture for M-131 or M-133.



Picture4. 9.1 M-131



Picture4. 9.2 M-133

Note : It will not work if you connect the DB9 interface connector of the electronic load to the RS232 interface connector of computer directly by a standard RS232 cable. Please use IT-E131 to connect them.

4.9.2 Communication between Power Supply and PC

The DB9 interface connector on the rear panel of the electronic load can be transferred to RS232 interface through the voltage level shift cable (M-131 or M-133) . The following instructions can help you understand how to control the output of power supplier by PC.

1. RS232 Setting

Before using the remote operation mode, please make sure that the baudrate and communication address in power supplier are the same as that in the computer software; otherwise, the communication will fail. You can change the baud rate and communication address from the front panel or from computer.

(1) Baud rate: 9600(4800, 9600, 19200, 38400, which are selectable from the menu on the front-panel.)

- (2) Data bit: 8
- (3) Stop bit: 1
- (4) Parity: (none, even, odd)

2. DB9 Serial Interface

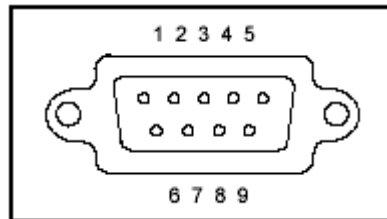

DB9 Serial Interface

- 1 +5V
- 2 TXD
- 3 RXD
- 4 NC
- 5 GND
- 6 NC
- 7 NC
- 8 NC
- 9 NC

The output of DB9 interface on the rear-panel of the power supplier is TTL voltage level, so the voltage level shift cable (M-131 or M133) must be applied before connecting the DB9 interface with the serial interface on PC.

M-131

Voltage Level Shift Cable

PC

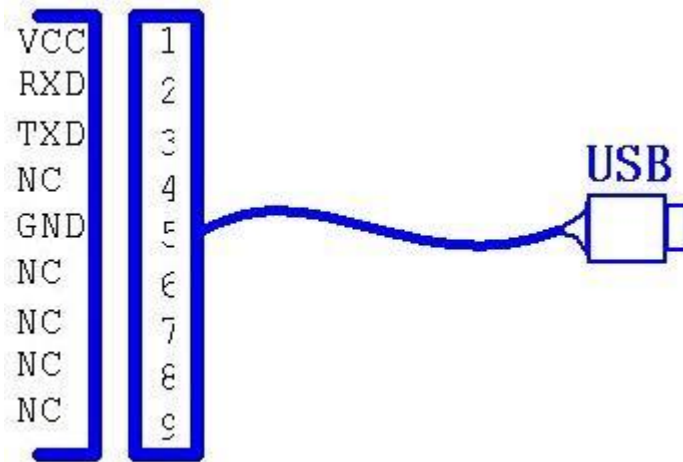
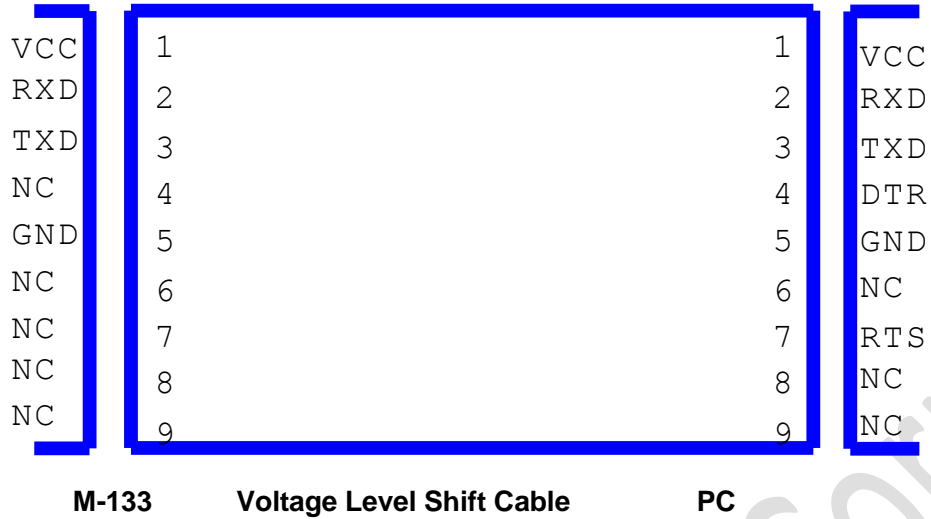

Note : It will not work if you connect the DB9 interface connector of the electronic load to the RS232 interface connector of computer directly by a standard RS232 cable. Please use IT-E131 or M133 to connect them.

Quick Reference

Safety

Please donot install any spare or repair the instrument without permission. In order to make sure the normal work of the instrument, please have it mended in the maintenance department designated by our company.

Pease review the following safety precautions before operating our equipment.

Safety Symbols

Please keep in mind the following items which may result in injuries on your body.



Connect it to safety earth ground using the wire recommended in the user manual.



High voltage danger (Non-professionals are forbidden to open the instrument)



The symbol on an instrument indicates that the user should refer to the operating Instructions located in the manual. please wear gloves when you start to ooperate and be ware of electronic shock..Don't use the equipment at the about personal safety place.

Certification and Warranty

M97 Series Electrical Loads meet its published specifications at time of shipment from the factory.

Warranty

This instrument product is warranted against defects in material and workmanship for a period of one year from date of delivery.

Maintenance Service

This product must be returned to maintenance department designated by our company for repairing. Customer shall prepay shipping charges (and shall pay all duty and taxes) for products returned to the supplier for warranty service. Except for products returned to customer from another country, supplier shall pay for return of products to customer.

Limitation of Warranty

The foregoing warranty shall not apply to

1. Defects resulting from improper or inadequate maintenance by the Customer,
2. Customer-supplied software or interfacing,
3. Unauthorized modification or misuse,
4. Operation outside of the environmental specifications for the product, or improper site preparation and maintenance.
5. Defects resulting from the circuit installed by clients themselves

Attention

No inform will be given for any changes in the content of the user's guide. thiscompany reserves the right to interpret.

AA Portable Power Corp.