



Powerline PassThru Adapters

User Manual

Models:

XAVB5401

XAVB5421

XAVB5602

XAVB5622

XAVB6504

September 2014
202-11314-03

350 East Plumeria Drive
San Jose, CA 95134
USA



Powerline PassThru Adapter

Support

Thank you for purchasing this NETGEAR product.

After installing your device, locate the serial number on the label of your product and use it to register your product at <https://my.netgear.com>. You must register your product before you can use NETGEAR telephone support. NETGEAR recommends registering your product through the NETGEAR website. For product updates, additional documentation, and support, visit <http://support.netgear.com>.

Phone (US & Canada only): 1-888-NETGEAR.

Phone (Other Countries): Check the list of phone numbers at <http://support.netgear.com/general/contact/default.aspx>.

Compliance

For regulatory compliance information, visit <http://www.netgear.com/about/regulatory>.

See the regulatory compliance document before connecting the power supply.

Trademarks

NETGEAR, the NETGEAR logo, and Connect with Innovation are trademarks and/or registered trademarks of NETGEAR, Inc. and/or its subsidiaries in the United States and/or other countries. Information is subject to change without notice. © NETGEAR, Inc. All rights reserved.

Contents

Chapter 1 Getting Started

Hardware Features	6
XAVB5401 Powerline 500 PassThru One-Port Adapter	6
XAVB5421 Powerline 500 PassThru One-Port Adapter	7
XAVB5602 Powerline 500 Nano PassThru Two-Port Adapter	8
XAVB5622 Powerline 500 Nano PassThru Two-Port Adapter	9
XAVB6504 Powerline 600 PassThru Four-Port Adapter	10
LED Descriptions	11
Button Descriptions	11
Ethernet Port	11
Extra Outlet	12
Product Label	12
How the Powerline PassThru Adapter Fits into Your Network	12
Set Up the Powerline Network	14
Set Up a New Powerline Network	14
Add the Adapter to an Existing Powerline Network	15
Powerline Network Security	16
Use the Security Button to Set the Encryption Key	16

Chapter 2 Using NETGEAR genie

Install NETGEAR genie	19
Powerline Map	20
Security Icon	21
View the Link Rate Between Powerline Devices	22
Change the Name of a Powerline Device	23
Turn LEDs Off or On	24
Set the Powerline Encryption Key	24
Reset a Device to Factory Default Settings	26
Add a Device to the Powerline Network	27

Chapter 3 Troubleshooting

Basic Functioning	30
Troubleshooting Buttons	30
Troubleshooting LEDs	30
LEDs Are Off When the Powerline Device Is Plugged In	30
Power LED	30
Pick A Plug LED	31
Ethernet LED Is Off	31
If You Do Not See All Your Devices with the NETGEAR genie	32

If You Do Not See the Powerline Icon on Your Network Map 32
Symantec Endpoint Protection 32

Appendix A Supplemental Information

XAVB5401 Technical Specifications 37
XAVB5421 Technical Specifications 38
XAVB5602 Technical Specifications 39
XAVB5622 Technical Specifications 40
XAVB6504 Technical Specifications 41
Safety Information 42

Getting Started

1

This chapter describes your Powerline PassThru adapter and how your adapter fits into a home network. It also explains the security features and how to secure your Powerline network with a private encryption key.

This chapter includes the following sections:

- *Hardware Features*
- *How the Powerline PassThru Adapter Fits into Your Network*
- *Set Up the Powerline Network*
- *Powerline Network Security*
- *Use the Security Button to Set the Encryption Key*

For more information about the topics covered in this manual, visit the NETGEAR support website at <http://support.netgear.com>.

Hardware Features

This section describes the hardware features of the Powerline PassThru adapters. Adapters vary by region. Your adapter might look different.

XAVB5401 Powerline 500 PassThru One-Port Adapter

The hardware features of the XAVB5401 adapter are shown in the following figure.

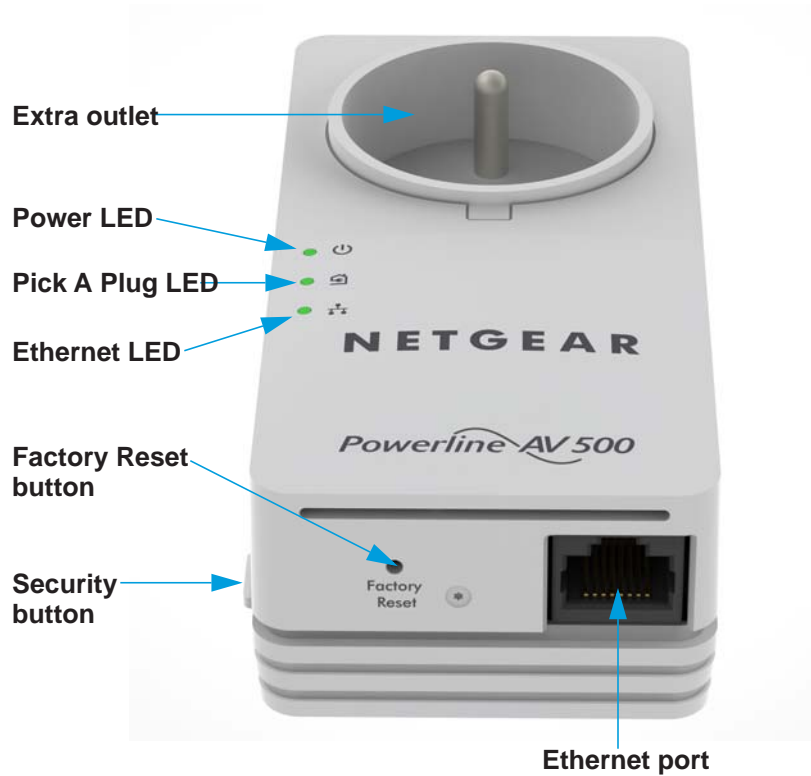

XAVB5421 Powerline 500 PassThru One-Port Adapter

The hardware features of the XAVB5421 adapter are shown in the following figure.

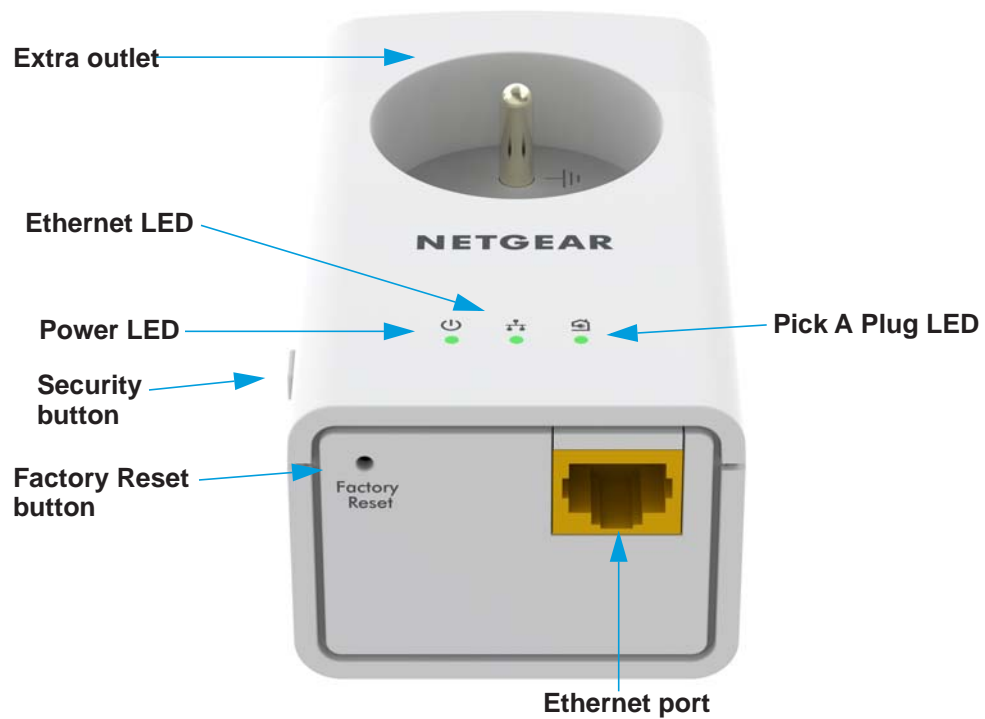

XAVB5602 Powerline 500 Nano PassThru Two-Port Adapter

The hardware features of the XAVB5602 adapter are shown in the following figure.

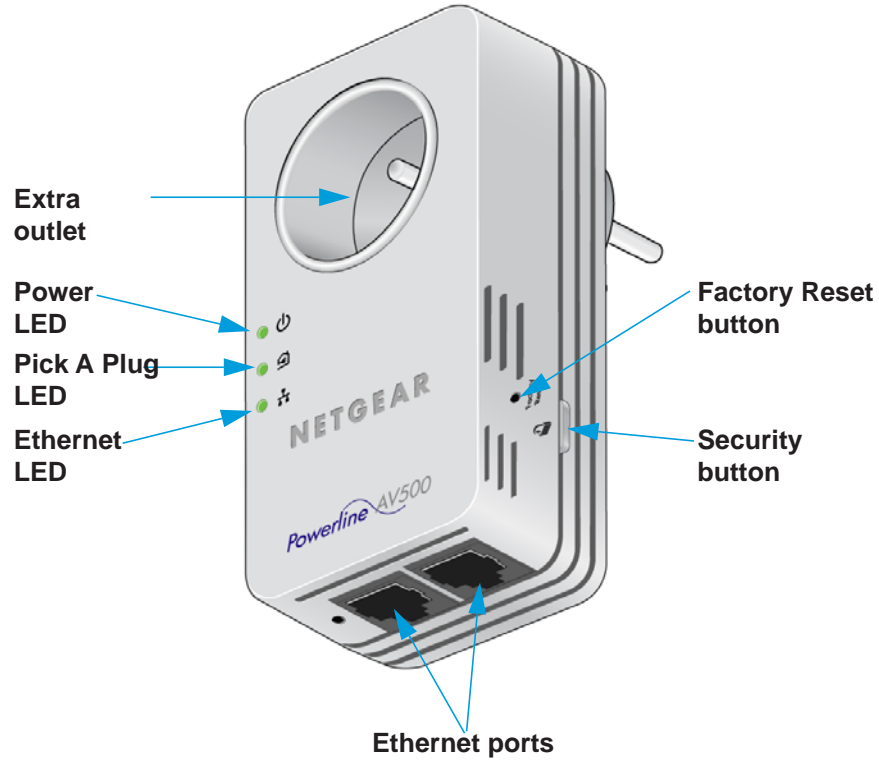

Figure 1. XAVB5602 hardware features

XAVB5622 Powerline 500 Nano PassThru Two-Port Adapter

The hardware features of the XAVB5622 adapter are shown in the following figure.

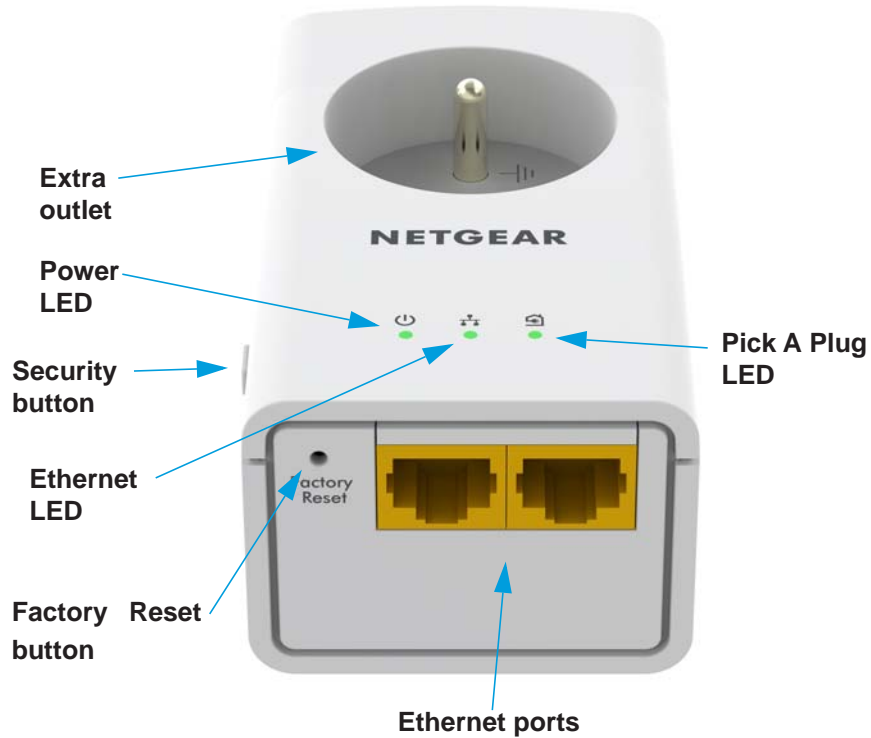

Figure 2. XAV5622 hardware features

XAVB6504 Powerline 600 PassThru Four-Port Adapter

The hardware features of the XAVB6504 adapter are shown in the following figure.

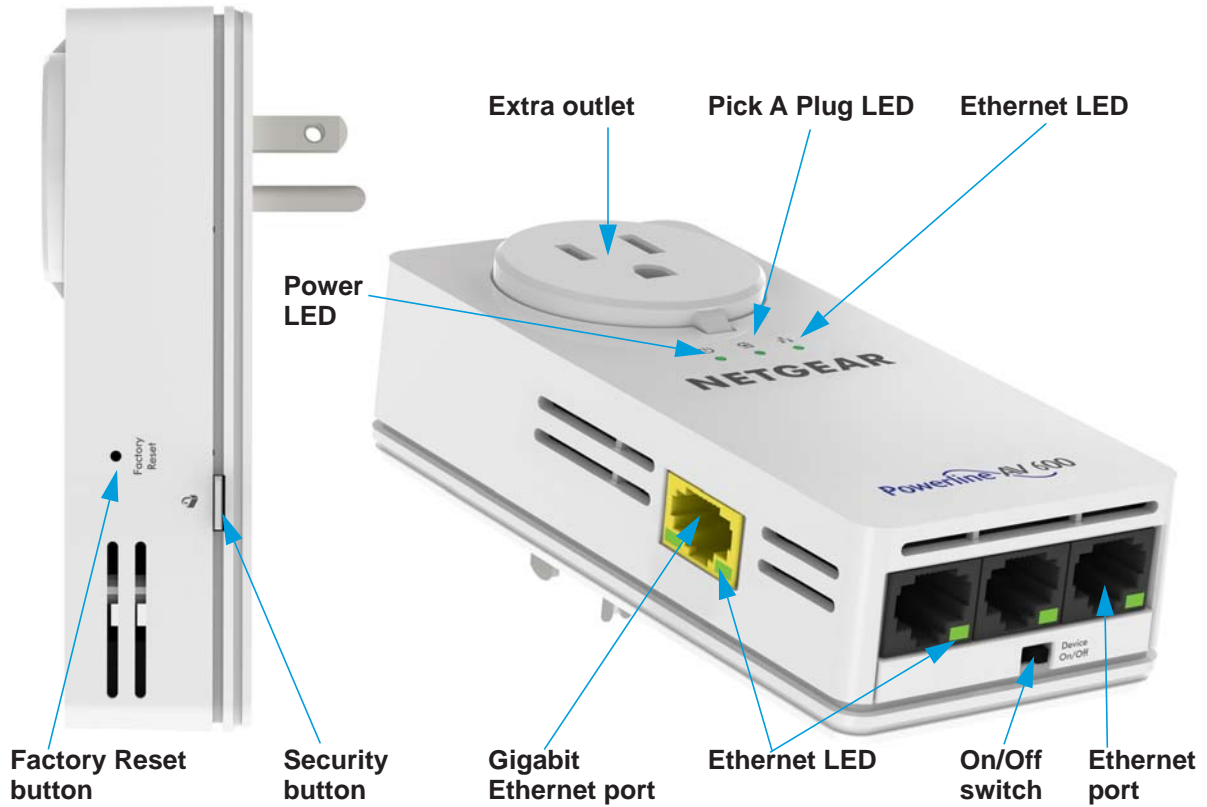





Figure 3. XAVB6504 hardware features

LED Descriptions

The LEDs indicate the status of your Powerline adapter.

Table 1. LED descriptions

Item	Description			
Power LED 	<ul style="list-style-type: none"> • Solid green. The electrical power is on. • Blinking green. The adapter is setting up security. • Blinking amber. The adapter is in power saving mode. If the Ethernet port is inactive for more than 10 minutes, the adapter enters power saving mode. • Off. The adapter does not have electrical power or the LEDs were turned off using NETGEAR genie. 			
Pick A Plug LED 	<ul style="list-style-type: none"> • Solid. The adapter is connected to a Powerline network. • Off. The adapter has not found any other compatible Powerline devices using the same encryption key. <p>The Pick A Plug feature lets you pick the electrical outlet with the fastest link rate, indicated by the color of the LED:</p> <table border="1"> <tr> <td>Green. Link rate > 80 Mbps (Fast)</td> <td>Amber. Link rate > 50 and < 80 Mbps (Medium)</td> <td>Red. Link rate < 50 Mbps (Slow)</td> </tr> </table>	Green. Link rate > 80 Mbps (Fast)	Amber. Link rate > 50 and < 80 Mbps (Medium)	Red. Link rate < 50 Mbps (Slow)
Green. Link rate > 80 Mbps (Fast)	Amber. Link rate > 50 and < 80 Mbps (Medium)	Red. Link rate < 50 Mbps (Slow)		
Ethernet LED 	<ul style="list-style-type: none"> • Solid green. The Powerline adapter is connected through the Ethernet port to a powered-on Ethernet device. • Off. There is no Ethernet connection. 			

Button Descriptions

Use the buttons on your Powerline adapter to do the following:

- **Factory Reset button.** Use the **Factory Reset** button to return your Powerline PassThru adapter to its factory default settings. Press the **Factory Reset** button for two seconds and release it.
- **Security button.** After the Powerline adapters are active, you can use the **Security button** to secure your Powerline network with a private encryption key. See [Use the Security Button to Set the Encryption Key](#) on page 16.
- **Power On/Off switch.** Use the **Power On/Off** switch to turn the device on and off. When this switch is in the Off position, the extra AC socket still receives power.

Ethernet Port

Powerline adapters use an Ethernet port to convert a standard electrical wall outlet into a high-speed wired network connection. You can use the wired network connection to bring Internet connectivity to any device with an Ethernet port, such as a computer, game console, Blu-ray player, smart TV, HD set-top box, or network DVR.

Extra Outlet

The extra outlet can remove some electrical noise that might affect Powerline performance. Plugging the power plugs of nearby devices into the filtered AC socket improves performance.

Product Label

The product label provides unique details specific to your device, including the following information:

- Model number
- Powerline MAC address
- Ethernet MAC address
- Serial number
- Device password

How the Powerline PassThru Adapter Fits into Your Network

You can use one or more Powerline adapters to extend Internet access throughout your home.

A Powerline network consists of two or more compatible Powerline devices that communicate with each other using your electrical power lines. One of the Powerline devices is connected with an Ethernet cable to your router so that the Powerline network is linked to your local area network (LAN). Connecting one Powerline device to your router allows all the Powerline devices on the Powerline network to communicate with the router and use its Internet connection.

The following illustration shows a Powerline network with one Powerline device in Room 1 and a second Powerline device in Room 2.

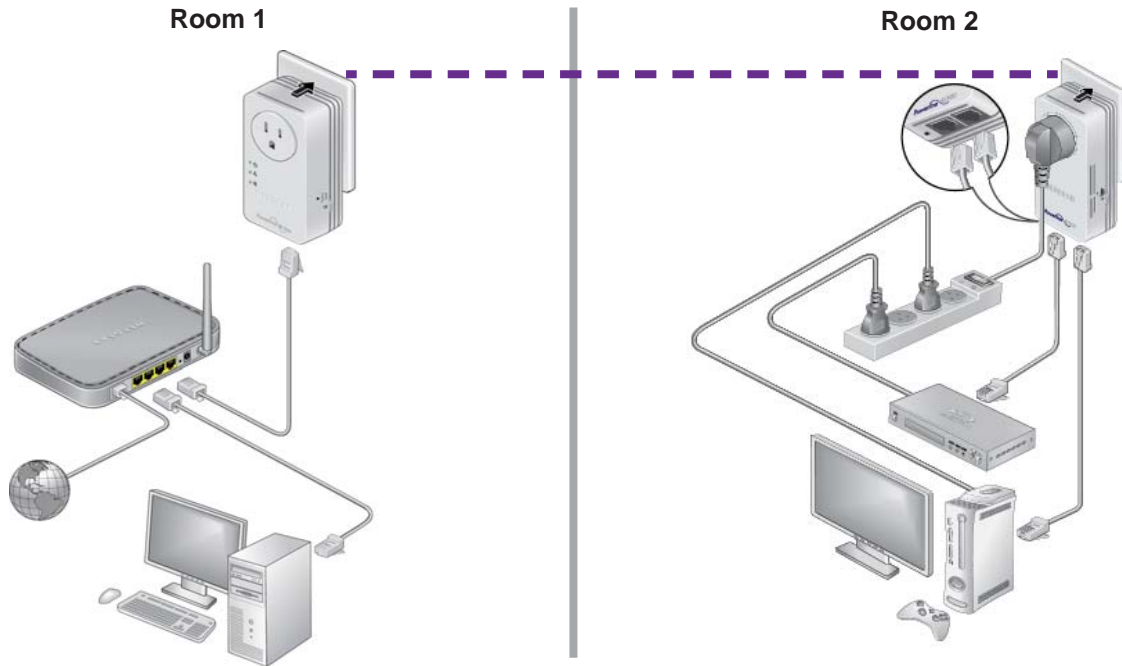

Figure 4. A Powerline network with two Powerline PassThru adapters

To form a Powerline network, you need at least two compatible Powerline devices.

For best performance, follow these guidelines when you plan the location of your Powerline devices:

- Use an electrical outlet that is not controlled by a wall switch to avoid accidentally turning off the power to the outlet.
- Avoid plugging Powerline products into electrical outlets that are located near appliances that consume a lot of power, such as washers, dryers, or refrigerators. Interference from these appliances might prevent Powerline products from working correctly or reduce Powerline network performance.
- Do not plug Powerline products into a power strip, extension cord, or surge protector. Connecting a Powerline product to one of these devices might prevent the product from working correctly or reduce Powerline network performance.



Set Up the Powerline Network

You can set up a new Powerline network that includes the Powerline PassThru adapter or you can add the Powerline PassThru adapter to an existing Powerline network.

Set Up a New Powerline Network

Different Powerline models can share the same Powerline network. All NETGEAR Powerline AV products are compatible.

➤ **To set up a new Powerline network:**

1. Make sure that your wired Ethernet connections are working:
 - a. If you have an existing wireless network, make sure that it is connected to the Internet.
 - b. On a computer that is connected to your router or gateway using an Ethernet cable, open a web browser and navigate to a web page.
 - c. On a computer or device that is connected to your wireless network, open a web browser and navigate to a web page.
2. Plug the one Powerline device into a wall outlet near your router or gateway.
3. Connect the device to the LAN port on your router or gateway using an Ethernet cable.
4. Plug the second Powerline device into a wall outlet where you want to add Internet access.
5. (Optional) Use the Ethernet cable that came with your adapter to connect the Powerline device to an Ethernet port on a computer, game console, Blu-ray player, or other peripheral device.

The Powerline devices attempt to detect each other and form a Powerline network.

6. Wait for the Powerline network to recognize each Powerline device.

This process could take as little as 5 seconds or up to 80 seconds.

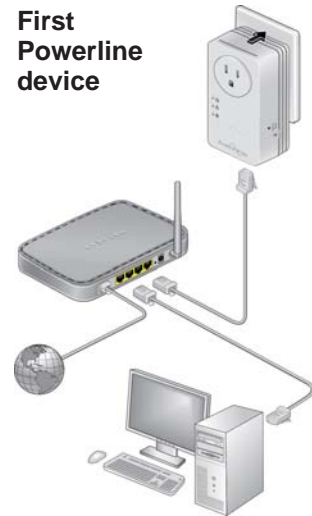

When the Power and Pick A Plug LEDs stop blinking, the process is complete. If the Pick A Plug LED is green or amber, the devices are successfully connected to the Powerline network. A red Pick A Plug LED indicates a slow link rate. In this case, move the Powerline device to another electrical outlet with a faster connection.

7. Secure your Powerline network.

See *Use the Security Button to Set the Encryption Key* on page 16.

Add the Adapter to an Existing Powerline Network

If you have an existing Powerline network, make sure that one of the Powerline devices is connected to your router or gateway so that the Powerline network is linked to your local area network (LAN). Your Powerline network must have two or more compatible Powerline devices that communicate with each other.

➤ To add the Powerline PassThru adapter to a Powerline network:

1. If you used the **Security** buttons or NETGEAR genie to secure your Powerline network, press the **Factory Reset** button for two seconds on each Powerline device to return it to its factory default settings.

This method is the quickest way to allow your Powerline PassThru adapter to communicate with the other Powerline devices.

2. Plug the Powerline PassThru adapter into a wall outlet where you want to add Internet access.
3. (Optional) Use the Ethernet cable that came with your adapter to connect the adapter to an Ethernet port on a computer, game console, Blu-ray player, or other peripheral device.

The Powerline devices attempt to detect each other and form a Powerline network.

4. Wait for the Powerline network to recognize each Powerline device.

This process could take as little as 5 seconds or up to 80 seconds.

When the Power and Pick A Plug LEDs stop blinking, the process is complete. If the Pick A Plug LED is green or amber, the devices are successfully connected to the Powerline network. A red Pick A Plug LED indicates a slow link rate. In this case, move the Powerline device to another electrical outlet with a faster connection.

5. Secure your Powerline network.

See *Use the Security Button to Set the Encryption Key* on page 16.

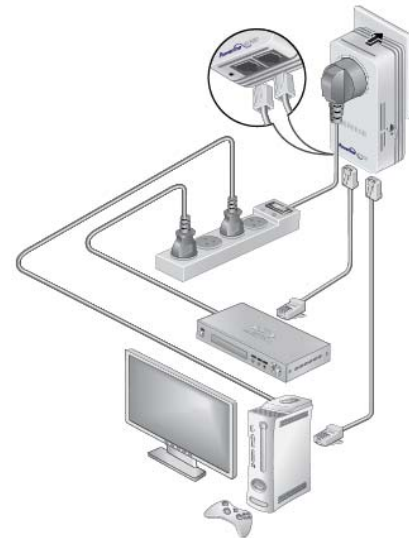

Powerline Network Security

A Powerline network consists of two or more Powerline devices using the same network encryption key. Securing your network is crucial. By encrypting the information that you send over the Powerline network, you help to keep it secure from hackers. If you do not set up security on your network, anyone nearby with a Powerline network can potentially use his or her connection to gain access to your network and information that you send over the Internet. This concern is especially relevant in settings such as apartment buildings, office buildings, dorm rooms, and other more populated areas.

You can use either the **Security** button on the Powerline device or NETGEAR genie to secure your Powerline network:

- Use the **Security** button on the Powerline device to automatically generate a random private encryption key. See *Use the Security Button to Set the Encryption Key* on page 16.
- Use NETGEAR genie to configure your Powerline network with a private encryption key that you specify. See *Chapter 2, Using NETGEAR genie*.

Use the Security Button to Set the Encryption Key

Note: A Powerline device can generate a random private encryption key only once. If you want to generate a new random key, first reset the Powerline devices to their factory default settings. Either press the **Factory Reset** button for two seconds, then release it, or use the NETGEAR genie factory reset feature. (See *Reset a Device to Factory Default Settings* on page 26.)

You can use the **Security** button to replace the default encryption key with a random private encryption key. The default encryption key is HomePlugAV.

➤ To set the encryption key:

1. Make sure that all of the Powerline devices that you want to configure are plugged in by checking that the Power and Pick A Plug LEDs on each device are lit solid green.



CAUTION:

Do not press the **Security** button on the Powerline devices until the Power and Pick A Plug LEDs on each Powerline device are lit solid green. Pressing the **Security** button too soon can temporarily disable Powerline communication. If Powerline communication is disabled, reset the Powerline device to its factory default settings by pressing the **Factory Reset** button for two seconds, then releasing it.

Powerline PassThru Adapter

2. Press the **Security** button on the first Powerline device for two seconds.

The Power LED starts blinking after you release the button. then the Powerline device automatically creates a new, randomly generated encryption key that all other Powerline devices on the network will use.

At this point, the Powerline devices cannot communicate with each other.

3. Within two minutes of pressing the **Security** button on the first Powerline device, press the **Security** button on the second Powerline device for two seconds.

You must press both **Security** buttons within two minutes.

The Power LED starts blinking after you release the button. This process allows the second Powerline device to use the same private encryption key as the first device so that they can communicate.

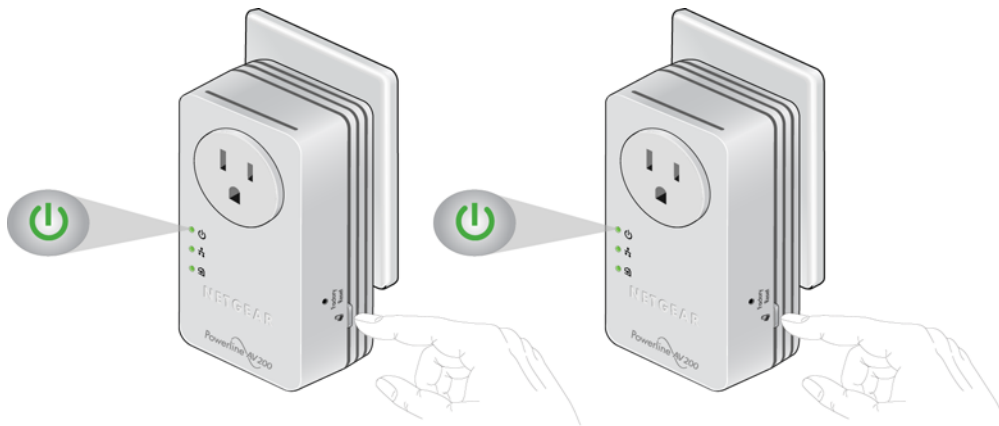

When the Power LEDs stop blinking and the Pick A Plug LEDs are lit solid green, the two devices can communicate over the Powerline network in a secure way.

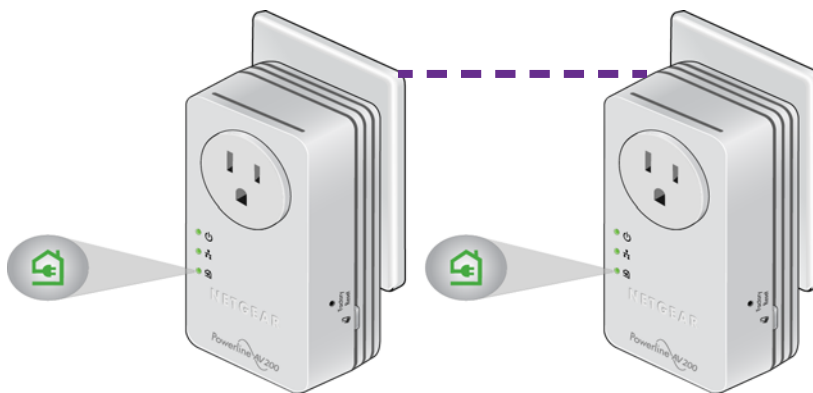

Note: This process works for only one pair of Powerline devices at a time. If you have more than two Powerline devices, repeat this process for each additional Powerline device to be configured. The devices retain security settings even if they are unplugged.

2. Using NETGEAR genie

This chapter explains how to install NETGEAR genie and use it to manage your Powerline network. NETGEAR genie works with all Powerline devices.

You can use NETGEAR genie to manage a local Powerline device that is connected to your computer with an Ethernet cable and also to manage other Powerline devices on the same network.

This chapter includes the following sections:

- *Install NETGEAR genie*
- *Powerline Map*
- *View the Link Rate Between Powerline Devices*
- *Change the Name of a Powerline Device*
- *Turn LEDs Off or On*
- *Set the Powerline Encryption Key*
- *Reset a Device to Factory Default Settings*
- *Add a Device to the Powerline Network*

Install NETGEAR genie

NETGEAR genie allows you to set a private encryption key for your Powerline network and manage devices on your Powerline network.

You can manage the Powerline network using any computer that is connected to your Powerline network. You can manage all devices on a Powerline network from one computer.

Note: If NETGEAR genie is already installed on your computer, you must reinstall the latest version to get support for Powerline products.

NETGEAR genie is a free download available from the NETGEAR website.

➤ **To install NETGEAR genie on your computer:**

1. Launch an Internet browser and visit www.netgear.com/genie.



The screenshot shows the NETGEAR genie website. At the top, it says "NETGEAR genie home networking simplified" with a green genie icon. Below this is a video player titled "Free Easy-to-Use Software" with a play button and the text "MONITOR CONTROL REPAIR". To the right of the video is the heading "Easily Manage Your Home Network" followed by three bullet points: "Easy dashboard to manage, monitor and repair your network", "My Media—Find and play music and video files anywhere in your network from your smartphone/tablet", and "Makes any printer AirPrint® compatible so you can print from an iPad® or iPhone®". Below the video are download buttons for PC, MAC, iPhone, iPad, and Android. To the right of these buttons is a desktop monitor displaying the genie dashboard and a smartphone displaying the genie app. A badge on the right says "NETGEAR genie Over 2 Million Downloads!".

2. Download the version of NETGEAR genie that corresponds to your operating system.
3. Run the file that you downloaded and follow the setup prompts to install NETGEAR genie.
4. Click the **Finish** button to complete the setup.

The NETGEAR genie shortcut icon displays on your desktop.



NETGEAR genie is installed on your computer.

Powerline Map

You can use genie's Powerline map to view and manage your Powerline network.

➤ **To navigate to the Powerline map:**

1. On a computer that is connected to your Powerline network, launch NETGEAR genie.
2. From the NETGEAR genie Home screen, click **Network Map** on the dashboard.



The Network Map screen displays.

3. Click the **Powerline** icon.

The Powerline map displays.

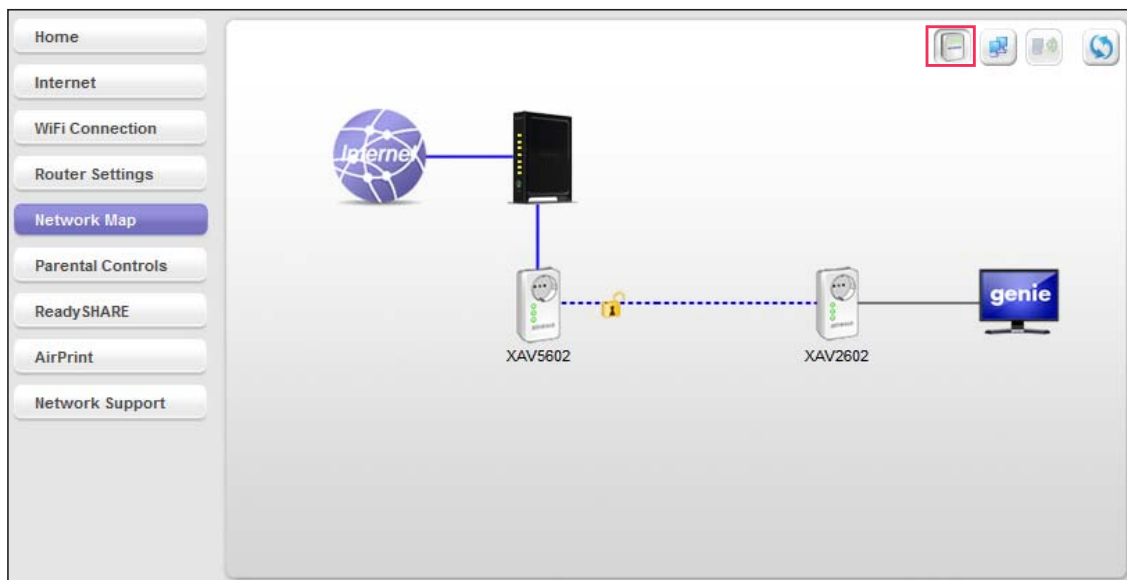

- To view management options, right-click the icon of the device that you want to manage. If all devices are not shown, click the **Refresh** icon to update the screen.
- To view more information about a device, move your cursor over a device icon.

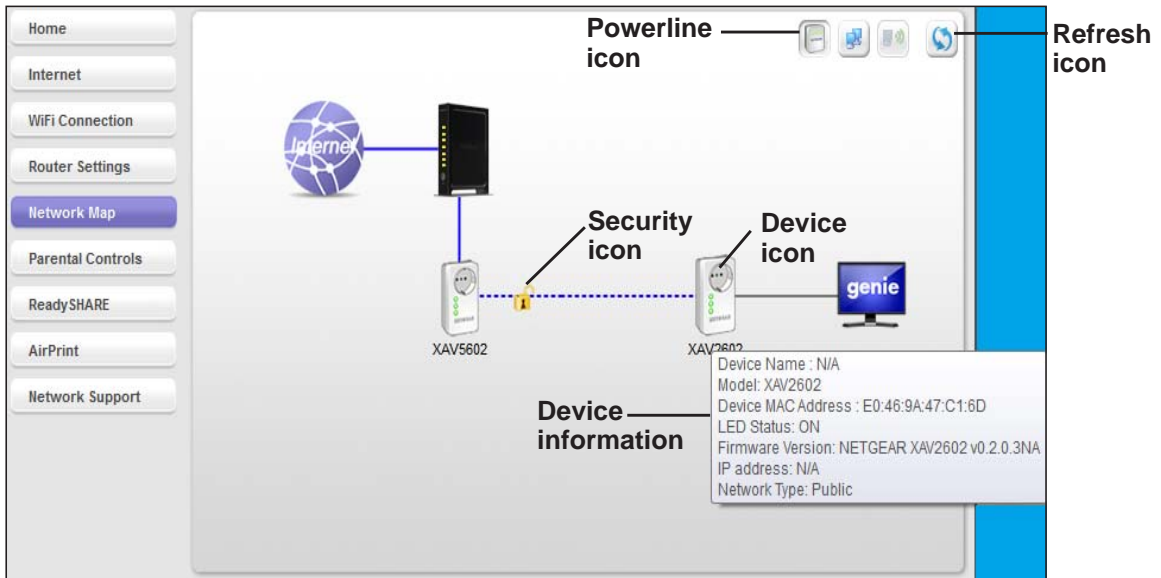

Security Icon

Click the **Security** icon on the Powerline map to go to the Security screen.

- If the Powerline devices are secured using the default encryption key, the unlocked Security icon displays.
- If the Powerline devices are secured using a private encryption key, the locked Security icon displays.



For more information about setting the encryption key, see [Set the Powerline Encryption Key](#) on page 24.

View the Link Rate Between Powerline Devices

- **To view the link rate between your Powerline devices:**

On the Powerline map, click the icon of the device whose link rate you want to view.

A pop-up screen displays.

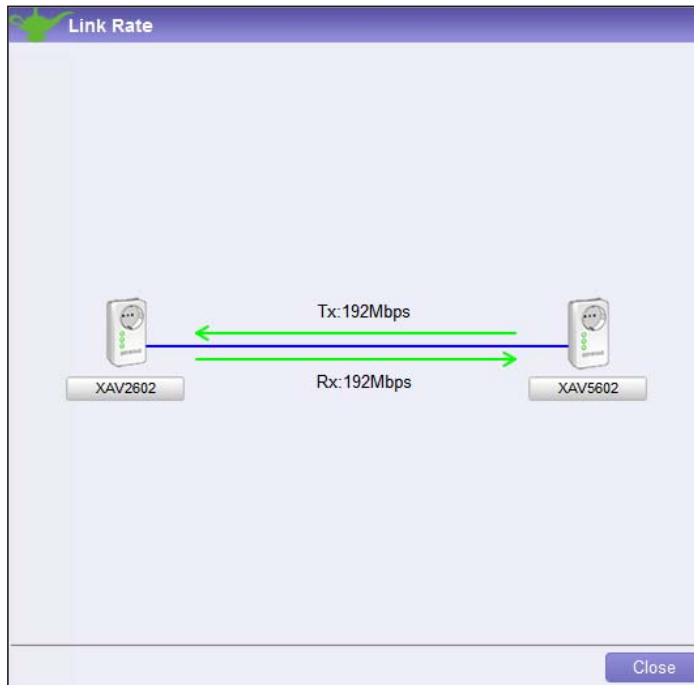

Tx indicates the rate at which the device is transmitting data. *Rx* indicates the rate at which the device is receiving data.

Change the Name of a Powerline Device

Powerline devices are identified by their model number and name. NETGEAR genie detects any Powerline devices that are connected to the Powerline network and displays them on the Powerline map. If you did not name the device, no name displays below the model number of the device.

➤ **To name a Powerline device on your Powerline network:**

1. On the Powerline map, right-click the icon of the device that you want to name.
2. On the pop-up menu that displays, select **Device Name**.

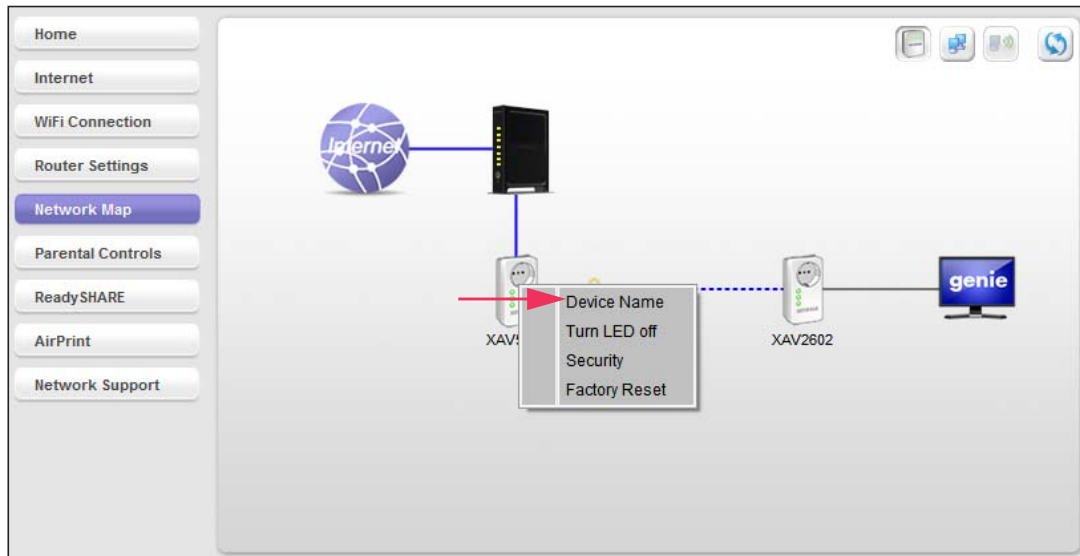

A pop-up screen displays advising you that connectivity will be temporarily lost while the device is being renamed.

3. Click the **OK** button.

The following screen displays:



4. Enter a new name for the Powerline device and click the **OK** button.
Your changes are saved.

Turn LEDs Off or On

You can turn off or turn on the LEDs of any device on your Powerline network.

➤ **To turn the LEDs off or on:**

1. On the Powerline map, right-click the icon of the device.
2. On the pop-up menu that displays, select either **Turn LED off** or **Turn LED on**.

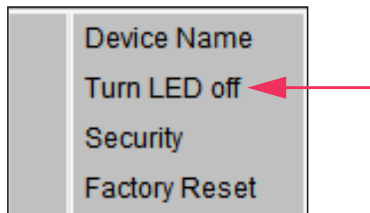

A pop-up screen displays advising you that connectivity will be temporarily lost while the LEDs are being reset.

3. Click the **OK** button.

A message displays indicating that the operation was successful.

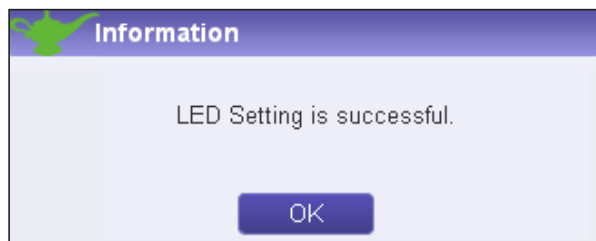

4. Click the **OK** button.

Set the Powerline Encryption Key

Powerline devices on the same Powerline network use the same encryption key. The factory default encryption key is HomePlugAV.

In locations such as apartment buildings or office buildings, other people might use the same electrical power lines that you use for your Powerline network. To protect your Powerline network from unwanted access, you can use NETGEAR genie to set a private encryption key for your Powerline devices. Make sure that all of your Powerline devices use the same encryption key so that they can communicate with each other.

If you forget your private encryption key, you can reset the encryption key to the factory default key, HomePlugAV. See [Reset a Device to Factory Default Settings](#) on page 26.

➤ **To set the encryption key:**

1. On the Powerline map, right-click the icon of a Powerline device in your network.

2. On the pop-up menu that displays, select **Security**.

The Security screen displays.

Security

Step1 Select Devices

Device Name	Model	MAC Address	Device Password
<input checked="" type="checkbox"/> un-named	XAV2602	E0:46:9A:47:C1:6D	XXXX-XXXX-XXXX-XXXX
<input checked="" type="checkbox"/> un-named	XAV5602	00:8E:F2:58:41:2D	

Password is not required for local device(XAV2602, MAC E0:46:9A:47:C1:6D)

Step2 Select an Encryption Key

Create a new Encryption Key

Use default Encryption Key HomePlugAV

Step3 Apply Changes

Apply Security to Selected Devices

Close

The top section of the Security screen shows information about each device that NETGEAR genie detects:

- **Device Name.** The list of Powerline devices that NETGEAR genie detects after completing a device scan. The device name is listed as un-named by default, but you can change it to a descriptive name, such as Office or Master Bedroom. (See [Change the Name of a Powerline Device](#) on page 23.)
 - **Model.** The model number of the Powerline device.
 - **MAC Address.** The MAC address of the Powerline device. This information is on the product label, which might not be visible when the device is plugged in.
 - **Device Password.** If your computer is not connected locally (with an Ethernet cable) to the device that you want to configure, you must enter the device password. The device password is on the product label.
3. Select the check box next to each device that you want to configure.
 4. Select an encryption key option for your Powerline devices:
 - **Create a new Encryption Key.** To set your own private encryption key, type the key that you want to use in the field.
 - **Use default Encryption Key.** When you select this radio button, the factory default encryption key automatically displays in the field. The factory default encryption key is HomePlugAV.

Note: If your computer is not connected locally (with an Ethernet cable) to the device that you want to configure, you must enter the device password. The device password is printed on the product label.

5. Click the **Apply Security to Selected Devices** button.

When the encryption key is set, a message displays indicating that the operation was successful.

6. Click the **OK** button.

Reset a Device to Factory Default Settings

You can reset the encryption key of a Powerline device to the factory default key, HomePlugAV.

Note: If your Powerline network uses a private encryption key, resetting a Powerline device to its factory default settings disconnects the device from the network. To avoid disconnecting your computer from the network, reset all other Powerline devices on the network before you reset the device that is connected to your computer.

➤ **To reset a device to its factory default settings:**

1. On the Powerline map, right-click the icon of the device that you want to reset.
2. On the pop-up menu that displays, select **Factory Reset**.

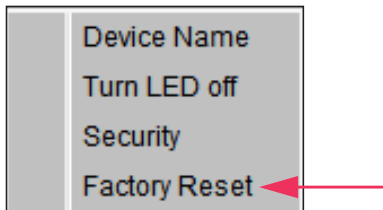

A pop-up screen displays advising you that connectivity will be temporarily lost while the device is being reset.

3. Click the **OK** button.

A message displays asking you to confirm the reset.

4. Click the **OK** button.

A message indicates whether the operation succeeded.

Add a Device to the Powerline Network

If you are adding a device to your Powerline network and your network uses the default encryption key, plug the new device into a power outlet.

If your Powerline network uses a private encryption key, you can set the security in one of two ways:

- Use the Security button to add the new device to your network. See *Use the Security Button to Set the Encryption Key* on page 16.
- Use NETGEAR genie to add the new device to your network, as described in the following procedure.

➤ To add a Powerline device to the Powerline network using NETGEAR genie:

1. Plug the Powerline device into a wall outlet near your computer for initial setup.
2. Connect the Powerline device to an Ethernet port on your computer using the Ethernet cable that came with your adapter.
3. Install NETGEAR genie on the computer.
See *Install NETGEAR genie* on page 19.
4. Launch NETGEAR genie on the computer and navigate to the Powerline map.
See *Powerline Map* on page 20.
5. Click the **Refresh** icon and wait for NETGEAR genie to detect the new device.

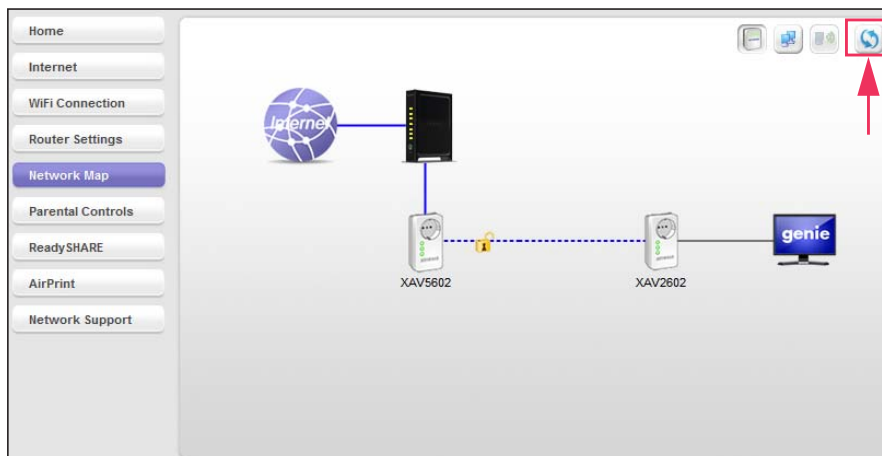

6. Right-click the new device's icon.
7. On the pop-up menu that displays, select **Security**.
8. Set the encryption key for the device.

See *Set the Powerline Encryption Key* on page 24.

Make sure that you enter the same encryption key that your other Powerline devices use.

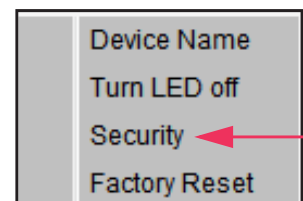

9. On the Powerline map, click the **Refresh** icon.
10. Verify that all the devices on your Powerline network display on the screen.
It might take a minute or two for NETGEAR genie to detect all devices on the network.

3 Troubleshooting

3

This chapter provides information to help you diagnose and solve problems that you might encounter. If you do not find the solution here, visit the NETGEAR support site at <http://support.netgear.com> for product and contact information.

This chapter includes the following sections:

- *Basic Functioning*
- *Troubleshooting Buttons*
- *If You Do Not See All Your Devices with the NETGEAR genie*
- *If You Do Not See the Powerline Icon on Your Network Map*
- *Symantec Endpoint Protection*

Basic Functioning

After you plug in the Powerline device, the following sequence of events occurs:

1. The Power LED lights.
2. After approximately ten seconds, verify the following:
 - The Power LED is solid green. The device is powered on.
 - If the device is connected to a Powerline network, the Pick A Plug LED is lit.
 - If the Powerline device is connected through the Ethernet port to a powered-on Ethernet device, the Ethernet LED is lit.

Troubleshooting Buttons

The **Factory Reset** and **Security** buttons are on the side panel of the Powerline device. Pressing the **Factory Reset** button longer than two seconds does not reset the device. Pressing the **Security** button longer than two seconds does not activate security.

Troubleshooting LEDs

The LEDs indicate activity; you can use them for troubleshooting.

LEDs Are Off When the Powerline Device Is Plugged In

Make sure that power is supplied to the electrical outlet.

If power is supplied and the LEDs stay off, someone might have used NETGEAR genie to turn off the LEDs. Use NETGEAR genie to check whether the LEDs are turned off. If they are turned off, you can use NETGEAR genie to turn them back on. See [Turn LEDs Off or On](#) on page 24.

Power LED

If the Power LED is off, the adapter does not have electrical power. Try these troubleshooting tips:

- Make sure that power is supplied to the electrical outlet and that the Powerline device is not plugged into an extension cord, power strip, or surge protector.
- Press the **Factory Reset** button on the Powerline device for two seconds to return the device to its factory default settings.

If the Power LED is blinking amber, the adapter is in power saving mode. The adapter enters power saving mode occurs when the Ethernet link is inactive for more than ten minutes. The Ethernet link is inactive if any of the following occurs:

- The Ethernet cable is unplugged.
- The peripheral device that is connected through the Ethernet port is turned off.
- The Powerline adapter is idle.

➤ **To wake a Powerline device from power saving mode:**

1. Connect a powered-on Ethernet device to one end of the Ethernet cable.
2. Connect the Powerline device to the other end of the Ethernet cable.

The Powerline device returns to normal mode within two seconds.

Pick A Plug LED

If the Pick A Plug LED is off, the Powerline devices cannot find each other. Try these troubleshooting tips:

- Make sure that the Powerline devices are plugged into wall outlets with power and that they use the same network encryption key.
- Move the Powerline device to an outlet that is closer to the computer or devices.
- If you set a private encryption key, make sure that all Powerline devices are using the same encryption key.
- If the problem occurred after you set the encryption key, reset each device to its factory default settings. Then try setting the encryption key again.
- **Amber or red.** Move the Powerline device to another electrical outlet with a faster connection.

Ethernet LED Is Off

If the Ethernet LED is off, the adapter does not have an Ethernet connection. Try these troubleshooting tips:

- If your Powerline device is connected to the LAN port of your router, check the following:
 - Your router and modem are turned on.
 - The computer connected directly to the router can access the Internet.
- If your Powerline device is connected to a computer, game console, Blu-ray player, or other peripheral device, check the following:
 - The peripheral device is turned on.
 - The Powerline device is securely connected to the peripheral device using an Ethernet cable.
- Press the **Factory Reset** button on each Powerline device for two seconds to return the device to its factory default settings.

If You Do Not See All Your Devices with the NETGEAR genie

If you click the **Refresh** icon on the NETGEAR genie Powerline map and you do not see all the devices that you expect, some Powerline devices might be using different encryption keys. If the encryption keys are different, do one of the following:

- Reset your Powerline devices to their factory default settings, then set the encryption key for all of your Powerline devices.
- Connect your computer to one Powerline device at a time and use NETGEAR genie to set the encryption key for each device.

If You Do Not See the Powerline Icon on Your Network Map

If you navigate to the Network Map on NETGEAR genie and you do not see the Powerline icon, try these troubleshooting tips:

- Make sure that you have the latest version of NETGEAR genie installed. Some older versions of NETGEAR genie might not support Powerline products.
- Temporarily disable your antivirus software and relaunch NETGEAR genie. Your computer's antivirus software might be blocking the Powerline communication protocol.

Symantec Endpoint Protection

The antivirus software Symantec Endpoint Protection v11.0.5002.333 filters the NETGEAR Powerline network traffic and prevents Powerline devices from appearing on the Network Map. To allow Powerline network traffic to pass through the Symantec Endpoint Protection filter, you must add a firewall rule to the filter.

Note: Symantec Endpoint Protection v12.0.1001.95 does not have this issue.

➤ To add a firewall rule for your Powerline devices:

1. Open the Symantec Control Center and click the **Options** button under Network Threat Protection.

2. Select **Configure Firewall Rules** from the menu.

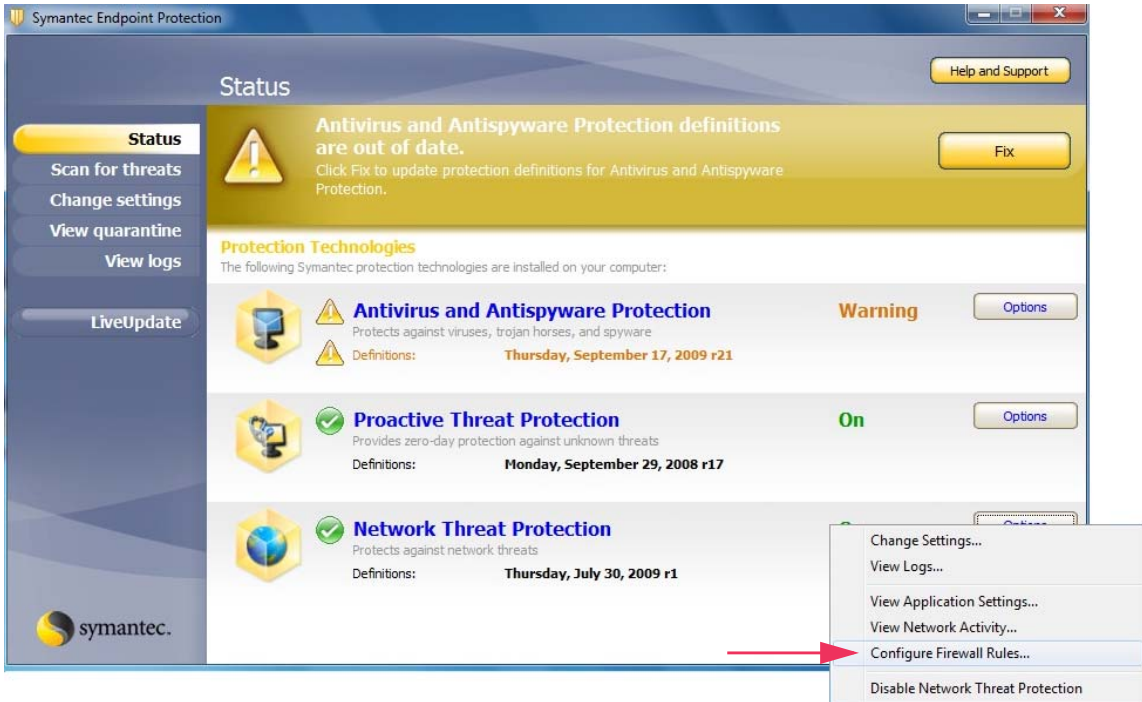

The following screen displays:

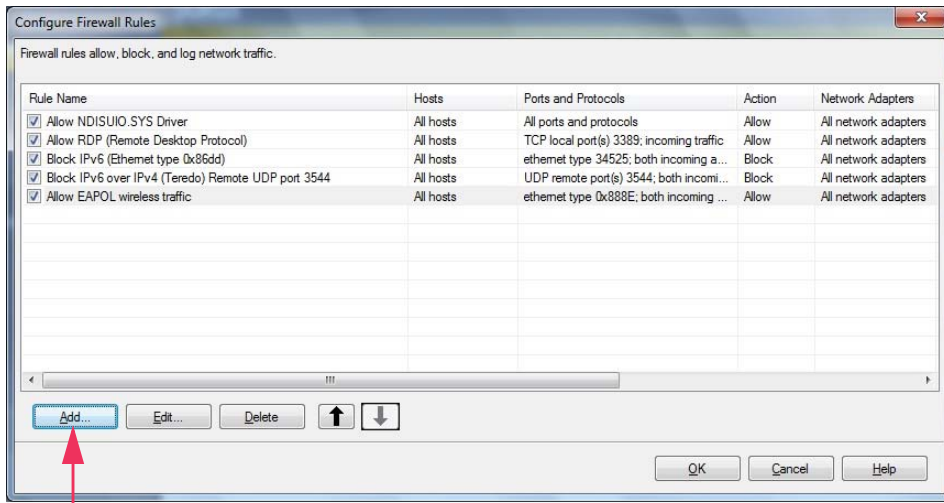

3. Click the **Add** button.

The following screen displays:

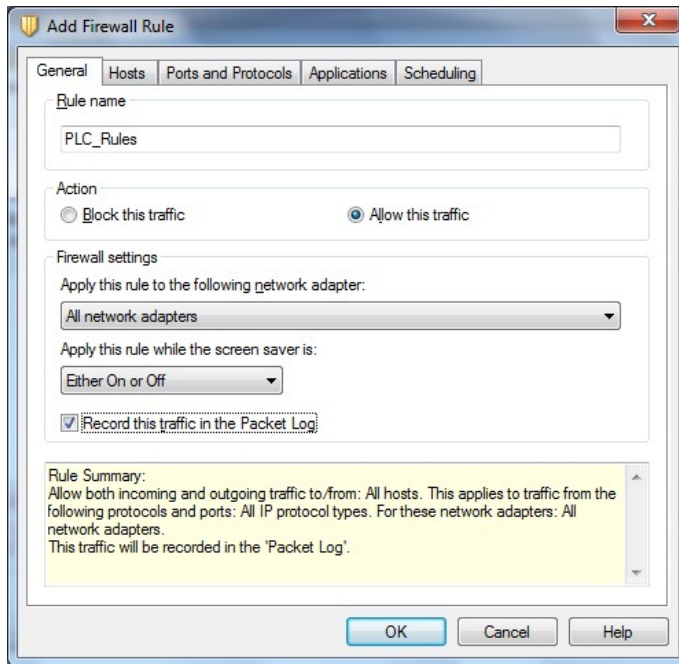

4. In the General tab, do the following:
 - a. In the **Rule name** field, type a name for the firewall rule.
 - b. Select the **Allow this traffic** radio button.
 - c. Configure the firewall settings as shown or as you prefer.
5. Click the **Ports and Protocols** tab.

The following screen displays:

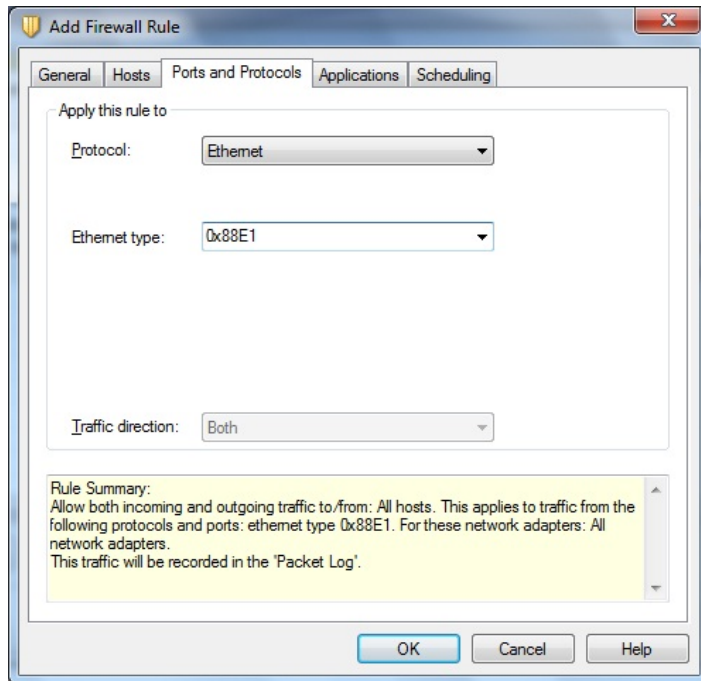

- a. From the **Protocol** drop-down menu, select **Ethernet**.
- b. In the Ethernet type field, type **0x88E1**.
- c. Click the **OK** button.

The rule displays in the firewall rule list.

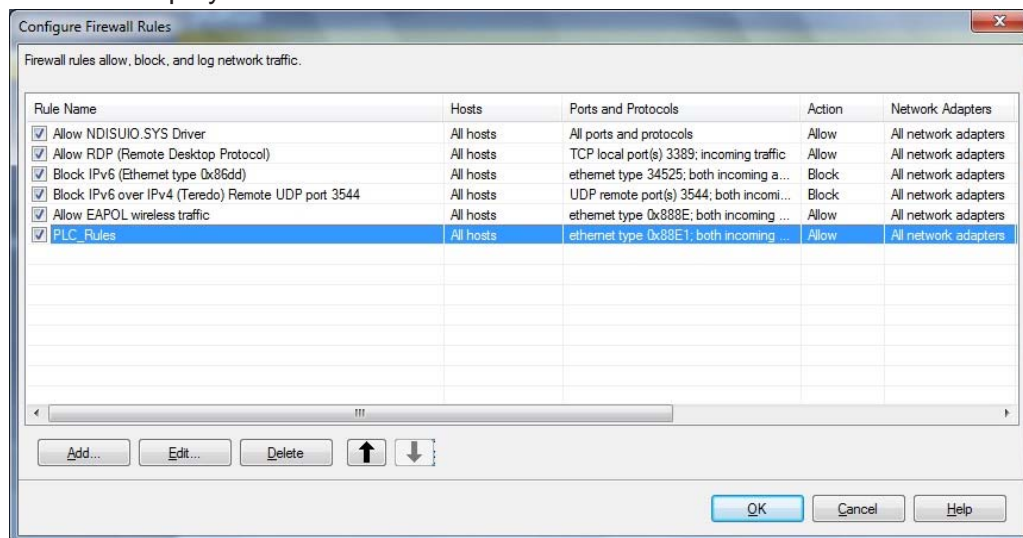

6. Make sure that the check box next to the rule is selected and click the **OK** button.
7. Restart the computer and launch NETGEAR genie.

The Powerline icon displays on the Network Map screen.

A Supplemental Information

A

This appendix provides technical specifications and safety information for Powerline PassThru Adapters.

This appendix includes the following sections:

- *XAVB5401 Technical Specifications*
- *XAVB5421 Technical Specifications*
- *XAVB5602 Technical Specifications*
- *XAVB5622 Technical Specifications*
- *XAVB6504 Technical Specifications*
- *Safety Information*

XAVB5401 Technical Specifications

The XAVB5401 adapter meets the technical specifications defined in the following table.

Table 2. XAVB5401 technical specifications

Feature	Specification
Data and routing protocols	IEEE 802.3 (10BASE-T), IEEE 802.3u (100BASE-Tx)
AC input	100–240V, 0.2A (max.)
Socket outlet rating (max. load)	AU: 10A, 250V; EU: 16A, 250V; NA: 15A, 125V; UK: 13A, 250V
Power consumption	Normal: 4W; Power saving mode: <0.5W
Dimensions	114 x 55 x 32.5 mm (4.49 x 2.17 x 1.28 in.)
Weight	0.174 kg (0.384 lb)
Operating temperature	0° to 40°C (32° to 104°F)
Operating humidity	10–90% maximum relative humidity, noncondensing
Storage humidity	5–95% maximum relative humidity, noncondensing
Security encryption type	128-bit AES
MAC addresses	8 (active), 16 (total): number of nodes that can be added to a single network
Bandwidth	500 Mbps
Compatibility	HomePlug AV IEEE 1901 (Not compatible with HomePlug v1.0 or HomePlug v1.0 Turbo)
Data transfer rate	Up to 500 Mbps with real throughput greater than 80 Mbps
Frequency band	2–75 Mbps
Modulation type	OFDM symbol modulation
Electromagnetic emissions	CE-EMC Class B
Safety agency approvals	IEC60950; CE LVD

XAVB5421 Technical Specifications

The XAVB5421 adapter meets the technical specifications defined in the following table.

Table 3. XAVB5421 technical specifications

Feature	Specification
Data and routing protocols	IEEE 802.3 (10BASE-T), IEEE 802.3u (100BASE-Tx)
AC input	100–240V, 0.2A (max.)
Socket outlet rating (max. load)	AU: 10A, 250V; EU: 16A, 250V; NA: 15A, 125V; UK: 13A, 250V
Power consumption	Normal: 4W; Power saving mode: <0.5W
Dimensions	114 x 55 x 32.5 mm (4.49 x 2.17 x 1.28 in.)
Weight	0.174 kg (0.384 lb)
Operating temperature	0° to 40°C (32° to 104°F)
Operating humidity	10–90% maximum relative humidity, noncondensing
Storage humidity	5–95% maximum relative humidity, noncondensing
Security encryption type	128-bit AES
MAC addresses	8 (active), 16 (total): number of nodes that can be added to a single network
Bandwidth	500 Mbps
Compatibility	HomePlug AV IEEE 1901 (Not compatible with HomePlug v1.0 or HomePlug v1.0 Turbo)
Data transfer rate	Up to 500 Mbps with real throughput greater than 80 Mbps
Frequency band	2–75 Mbps
Modulation type	OFDM symbol modulation
Electromagnetic emissions	CE-EMC Class B
Safety agency approvals	IEC60950; CE LVD

XAVB5602 Technical Specifications

The XAVB5602 adapter meets the technical specifications defined in the following table.

Table 4. XAVB5602 technical specifications

Feature	Specification
Data and routing protocols	IEEE 802.3 (10BASE-T), IEEE 802.3u (100BASE-Tx)
AC input	100–240V, 0.2A (max.)
Socket outlet rating (max. load)	AU: 10A, 250V; EU: 16A, 250V; NA: 15A, 125V; UK: 13A, 250V
Power consumption	Normal: 4W; Power saving mode: <0.5W
Dimensions	114 x 55 x 32.5 mm (4.5 x 2.2 x 1.28 in.)
Weight	174 g (0.38 lb)
Operating temperature	0° to 40°C (32° to 104°F)
Operating humidity	10–90% maximum relative humidity, noncondensing
Storage humidity	5–95% maximum relative humidity, noncondensing
Security encryption type	128-bit AES
MAC addresses	8 (active), 16 (total): number of nodes that can be added to a single network
Bandwidth	500 Mbps
Compatibility	HomePlug AV IEEE 1901 (Not compatible with HomePlug v1.0 or HomePlug v1.0 Turbo)
Data transfer rate	Up to 500 Mbps with real throughput greater than 80 Mbps
Frequency band	2–75 Mbps
Modulation type	OFDM symbol modulation
Electromagnetic emissions	FCC Part 15 Class B; CE-EMC Class B; 3-home FCC Certificate
Safety agency approvals	UL Listed (UL 1950) /cUL IEC950; CE LVD; TUV CB, TUV CG

XAVB5622 Technical Specifications

The XAVB5622 adapter meets the technical specifications defined in the following table.

Table 5. XAVB5622 technical specifications

Feature	Specification
Data and routing protocols	IEEE 802.3 (10BASE-T), IEEE 802.3u (100BASE-Tx)
AC input	100–240V, 0.2A (max.)
Socket outlet rating (max. load)	AU: 10A, 250V; EU: 16A, 250V; NA: 15A, 125V; UK: 13A, 250V
Power consumption	Normal: 4W; Power saving mode: <0.5W
Dimensions	114 x 55 x 32.5 mm (4.5 x 2.2 x 1.28 in.)
Weight	174 g (0.38 lb)
Operating temperature	0° to 40°C (32° to 104°F)
Operating humidity	10–90% maximum relative humidity, noncondensing
Storage humidity	5–95% maximum relative humidity, noncondensing
Security encryption type	128-bit AES
MAC addresses	8 (active), 16 (total): number of nodes that can be added to a single network
Bandwidth	500 Mbps
Compatibility	HomePlug AV IEEE 1901 (Not compatible with HomePlug v1.0 or HomePlug v1.0 Turbo)
Data transfer rate	Up to 500 Mbps with real throughput greater than 80 Mbps
Frequency band	2–75 Mbps
Modulation type	OFDM symbol modulation
Electromagnetic emissions	FCC Part 15 Class B; CE-EMC Class B; 3-home FCC Certificate
Safety agency approvals	UL Listed (UL 1950) /cUL IEC950; CE LVD; TUV CB, TUV CG

XAVB6504 Technical Specifications

The XAVB6504 adapter meets the technical specifications defined in the following table.

Table 6. XAVB6504 technical specifications

Feature	Specification
Data and routing protocols	IEEE 802.3 (10BASE-T), IEEE 802.3u (100BASE-Tx)
AC input	100–240V, 0.2A (max.)
Socket outlet rating (max. load)	AU: 10A, 250V; EU: 16A, 250V; NA: 15A, 125V; UK: 13A, 250V
Power consumption	Normal: 4W; Power saving mode: <0.5W
Dimensions	114 x 55 x 32.5 mm (4.5 x 2.2 x 1.28 in.)
Weight	174 g (0.38 lb)
Operating temperature	0° to 40°C (32° to 104°F)
Operating humidity	10–90% maximum relative humidity, noncondensing
Storage humidity	5–95% maximum relative humidity, noncondensing
Security encryption type	128-bit AES
MAC addresses	8 (active), 16 (total): number of nodes that can be added to a single network
Bandwidth	600 Mbps
Compatibility	HomePlug AV IEEE 1901 (Not compatible with HomePlug v1.0 or HomePlug v1.0 Turbo)
Data transfer rate	Up to 600 Mbps with real throughput greater than 80 Mbps
Frequency band	2–75 Mbps
Modulation type	OFDM symbol modulation
Electromagnetic emissions	FCC Part 15 Class B; CE-EMC Class B; 3-home FCC Certificate
Safety agency approvals	UL Listed (UL 1950) /cUL IEC950; CE LVD; TUV CB, TUV CG

Safety Information

Follow these safety guidelines to ensure your own personal safety and to help protect your system from potential damage:

- For national approvals (approval schemes other than CB), relevant national standards for plug, socket-outlet, and direct plug-in units (for example, US) shall also be consulted while testing and approving such products according to the national standards.
- Check the electrical current for any device plugged into the filtered AC socket. Do not exceed home and product outlet ratings and electrical requirements.
- The socket-outlet shall be installed near the equipment and be easily accessible.
- Only power cords are allowed to be inserted into the filtered AC socket; no other equipment with a direct plug-in is allowed. Power cords needs to be a maximum of 1 m long and a minimum of 0.75 mm² of cross-sectional area.
- Do not plug devices into the Powerline PassThru Adapter filtered AC outlet that exceed the product ratings. The output voltage of the filtered AC outlet is the same as the power outlet that the Powerline PassThru Adapter is plugged into. To help avoid damaging your system, be sure that the attached devices are electrically rated to operate with the power available in your location.
- If the input AC voltage is less than 100 Vac, the device plugged into the filtered AC socket of the Powerline PassThru Adapter might not perform as well as expected.
- **DO NOT PLUG MAJOR HOME APPLIANCES** into the filtered AC socket or into an attached power strip. The device is not intended to be used with home appliances such as air conditioners, power tools, space heaters, fans, hair dryers, ovens, or refrigerators.
- Actual data throughput will vary. Network conditions and environmental factors, including volume of network traffic, building materials and construction, and network overhead, lower actual data throughput rate.
- Do not service any product except as explained in your system documentation.
- Opening or removing covers that are marked with the triangular symbol with a lightning bolt can expose you to electrical shock. Only a trained service technician should service components inside these compartments.
- Use the product only with approved equipment.
- Allow the product to cool before removing covers or touching internal components.
- To help avoid damaging your system, be sure that the voltage selection switch (if provided) on the power supply is set to match the power available at your location:
 - 110 volts (V), 60 hertz (Hz) in most of North and South America and some Far Eastern countries such as South Korea and Taiwan
 - 100V, 50 Hz in eastern Japan and 100V, 60 Hz in western Japan
 - 230V, 50 Hz in most of Europe, the Middle East, and the Far East
- The peripheral power cables are equipped with three-prong plugs to help ensure proper grounding. Do not use adapter plugs or remove the grounding prong from a cable.

Powerline PassThru Adapter

- Observe extension cable and power strip ratings. Make sure that the total ampere rating of all products plugged into the extension cable or power strip does not exceed 80 percent of the ampere ratings limit for the extension cable or power strip.
- To help protect your system from sudden, transient increases and decreases in electrical power, use a surge suppressor, line conditioner, or uninterruptible power supply (UPS).
- For additional safety instructions, visit <http://www.netgear.com/about/regulatory>.