

mitsubishi

Mitsubishi Electric Air Conditioning Network System BACnet™ Interface: PAC-YG31CDA (Ver. 1.30) Operation Manual

Contents

1.Safety Precautions1
2.System Requirements2
3.System Configuration4
4.Functional specification6
5.Installation16
6.Part Name and Functions20
7.Initial Startup and Shutdown22
8.System Setting Procedure22
9.Site Adjustment33
Appendix1: Auto Log – In Confirmation Method	
Appendix2: Initial Value	
Appendix3: Correcting the system setting data when PC fails or is replaced.	

Please read this manual before using the unit.
Please keep this manual for future use.

WT04221X03
2004-Mar. (Ver. 1.30)

Contents

1.Safety Precautions1
2.System Requirements3
2.1 Requirements (system recommendations)3
2.2 Compatible Airconditioner3
2.3 Restrictions4
3.System Configuration5
3.1 System Configuration Example5
3.2 Hardware Connection Diagram5
3.3 Group Configuration6
4.Functional specification7
4.1 Communications protocol specification7
4.2 Object List8
4.3 Object and Management Item9
4.4 Service List11
4.5 Service list for every object12
4.6 Event service specification13
4.7 Function13
4.8 Setting functional list14
5.Installation15
5.1 Pre-Installation Steps15
5.2 BACnetIF Set up16
5.3 BACnetIF Uninstall18
6.Part Names and Functions19
6.1 Window Elements19
6.2 Basic Mouse Operation19
7.Initial Startup and Shutdown20
7.1 Before Startup20
7.2 Start up20
7.3 Shutdown20
8.System Setting Procedure22
8.1 Start up [SetBACnet]22
8.2 Shutdown [SetBACnet]22
8.3 Window Elements23
8.4 Open/Close file23
8.5 Get/Put System Settings23
8.6 System Setting Procedure24
8.7 Setup for G-50A24
8.8 Setup for BACnet27
8.9 System Setup32
9.Site Adjustment33
9.1 Site Adjustment33
9.2 Tools for Site Adjustment34
9.3 Step1:	
Test operation from Centralized controller G-50A34
9.4 Step2:	
Initial Setting of BACnetIF35
9.5 Setting Check36
9.6 Step3:	
Test operation from BMS37

Appendix 1: Auto Log – In Confirmation Method

Appendix 2: Initial Value

Appendix 3: Correcting the system setting data when PC fails or is replaced.

In this manual, Microsoft® Windows® XP Professional is called Windows XP.

Trademarks



MS, Microsoft, Microsoft logo, and Windows are registered trademarks and trade names of Microsoft Corporation.

BACnet™ is a registered trademark of ASHRAE (American Society of Heating, Refrigerating and Air – Conditioning Engineers, Inc.).

Each company may use as registered trademarks and trade names the product names used in this manual.

1. Safety Precautions

- Please read the Safety Precautions section very carefully before using the unit.
- The safety cautions provided here are very important for your safety. Please observe them at all times.
- The degrees of danger involved with incorrect operation of the unit are indicated in this manual using the following symbols.

- | | |
|--|---|
|  WARNING | Incorrect operation could result in death or severe injury. |
|  CAUTION | Incorrect operation could result in injury or damage to property. |

- After reading this information, please keep this manual in a location where the operator can see it. Also, when changing operators give this manual to the new operator.

Note: Please observe the safety precautions detailed in the installation manuals and operation manuals of the other machines such as computers, peripherals, and air conditioners.

WARNING

The customer must not do any wiring or electrical work.

Have the dealer or a specialist do any wiring or electrical work. Do not do it yourself. Doing the work you may result in improper installation, which may cause electric

Do not relocate the unit yourself.

Relocating the unit you may result in incorrect installation, which may cause electric shock or fire. To relocate the unit, consult the company from which the unit was purchased.

Do not make any improvements or repairs for any reason.

Making improper improvements or repairs may cause electric shock or fire. For repairs, consult the company from which the unit was purchased.

Read the installation manuals and operation manuals for the computer, peripherals and other machines.

Improper operation could result in fire or damage to the computer or peripherals.

Stop operation immediately if an error message appears on the computer and the unit stops or is not operating properly.

Failing to do so may result in fire or damage to the unit. Immediately contact the company from which the unit was purchased.

Read the installation manual and operation manual for the air conditioner controller.

Improper operation could result in fire or damage to the air conditioner controller.

CAUTION

Do not use the product for any other purpose.

This product is for use with the Mitsubishi Electric Building Air Conditioning Control System. Do not use it with any other air conditioning control system or for any other application. Doing so may cause the unit to malfunction.

Keep children away from the unit.

Inspections and maintenance can be dangerous. Do not let children near the unit during these times.

Do not use with other applications.

Use the PC that uses this product with this product only. Using it with other applications may cause faulty operation.

Warning to all users (User Agreement)

This document is a contract between the customer and Mitsubishi Electric Corporation. By using this application, you agree to the following conditions and are considered a user.

- Mitsubishi Electric and associated suppliers are not responsible for any collateral, secondary, or special damages, even if notified by the distributor of the possibility of a certain type of damage. Mitsubishi Electric is not responsible for any rights claimed by a third party.

Safety Guidelines for the Computer Running the Integrated PAC-YG31CDA Software (Summary)

1. Selecting a Computer

Selecting a desktop

- Depending on the function, it is recommended to use a desktop as opposed to a laptop computer as there is a tendency for heat to build up in a laptop.

Computer based UPS recommended

- It is recommended to use a UPS to protect data from momentary power outages or power cuts.

Use a computer/operating environment with specifications capable of running the PAC-YG31CDA function.

- Run the function using the specified OS. There is a possibility that the function cannot be used when running an OS other than specified.
- Use a business model computer. There are cases when it is not possible to install or run the application with other applications on a computer or laptop intended for personal use.

2. Precautions for General Usage

Do not place the computer in any of the following locations.

- An error or accident may occur when using in the following environments.
A place where there is: a lot of dust, a likelihood of shock or vibration, instability, a heater or speaker nearby, direct exposure to sunlight, a likelihood of dropping, a possibility that the computer may be exposed to moisture or high temperature, or where it may be exposed to sudden temperature fluctuations or heat.

Ensure to read the computer/peripheral instruction manual.

- A fire or accident may occur due to improper use of the equipment.

Avoid covering the computer or AC adapter with a cloth or blanket, or locating them on or near a heater.

- There is a possibility of internal temperature build-up, fire or burning under the above situations.

Do not close the lid when using a laptop.

- There is a possibility of an internal temperature build-up, fire or burning. Use in an area with sufficient ventilation.

Cut the power or disconnect the power cable immediately if smoke, or an abnormal smell or noise emanates from the computer.

- Using the computer in the above circumstances may result in fire, burning, or electric shock. Please consult the maker of the equipment/computer.

Do not touch the computer air vent.

- The air emitted by the ventilator is hot and may result in burning if exposed to the skin.

Use the hard disk, floppy disk, or CD media as indicated.

- Do not expose the hard disk, floppy disk, or CD to shock or vibration during use.
- Do not cut the power or reboot the computer while the hard disk, floppy disk, or CD is in use.
- Always turn OFF the power when moving the computer.

Do not tamper with the computer fan.

- Tampering with the computer fan may result in a temperature build-up, fire, or accident.

3. Other Precautions

Precautions relating to the computer and peripheral equipment

- Please consult the maker regarding damage to the computer or peripheral equipment. We will not be held responsible for damage occurring at the user's site.

2. System Requirements

2.1 Requirements (system recommendations)

We recommend the following software and hardware when using this application (PAC-YG31CDA; BACnet IF).

Item	Contents	Note
PC	PC/AT interchangeable machine	
CPU	Pentium 4 1.8GHz or faster	
Memory	256 MB or more	
HDD	2GB or more	4GB or more of C drive free space necessary
Storage device	CD-ROM drive	It is used at the time of installation of BACnetIF.
Resolution	1024 × 768 or higher, 65536 colors or more	
LAN	2 port or more Internal LAN (10Mbps)	*1
OS	Windows XP Professional Service Pack 2 and above	English version only *PC must support each OS.
Other	PC must be dedicated for this use (BACnet IF).	It is always used as operation for 24 hours.

*1 Purchase the option, or use the equipment recommended for the PC when purchasing the PC.

2.2 Compatible Airconditioner

BACnet IF has functions: air conditioner controller.

Compatible Airconditioner and function list (O: supported, ×: Not supported)

Model	Function (Control/Maintenance)
Y series	○
Super Y series	○
R2 series	○
WR2 series	○
WY series	○
Multi S series	○
Free plan Indoor unit	○
Free plan LOSSNAY	○
LOSSNAY with heating/ humidifying	○
"A" control type	○ (An adapter is required)
"K" control type	○ (An adapter is required)

2.3 Restrictions

The following restrictions apply to the BACnet IF program.

(1) System configuration limits

	Number of units	Note
G-50A	Max. 10 units	G-50A Ver. 2.50 or higher
Indoor unit	Max. 50 units/G-50A	Max. 500 units (including all IC, KIC, AIC, LC, and FU)

[Symbol] IC: Indoor unit, LC: LOSSNAY, FU: OA processing unit, AIC: "A" controller, KIC: "K" controller

Checking the G-50A version

Check the centralized controller G-50A version. Update if it is not the applicable version.

Method 1: Using the initialization tool

The version can be monitored from the Basic Setting window.

Method 2: Using the G-50A main unit

Press the [↑][↓] buttons for two seconds or longer to open the Initialization Mode

Menu window. Then [←] button to open the second menu window. The version will appear at the lower right.

* If the integrated centralized control software TG-2000A has already been installed, the G-50A version can be confirmed with Operation Manual TG-2000A.

Updating the G-50A

Update by the Update Program CD (for G-50A).

(2) Correspondence at the time of abnormalities

•For the period under reboot of PC, failure of G-50A, etc., neither each control nor a function may operate normally.

(3) Operation at the time of a power failure

•If a power failure occurs, the power supply of a PC will also fall.

When the power restores, it is necessary to turn on and start a power switch again.

Use of UPS is recommended in the place where a power supply state is unstable.

(4) Function description

•The function/specifications may partially change and improvements may be made without any notice.

Note:

- The BACnet license number must be registered in each central controller G-50A to use this software BACnet IF.
- Make sure that the license number corresponding to use is registered in the central controller G-50A.

3. System Configuration

3.1 System Configuration Example

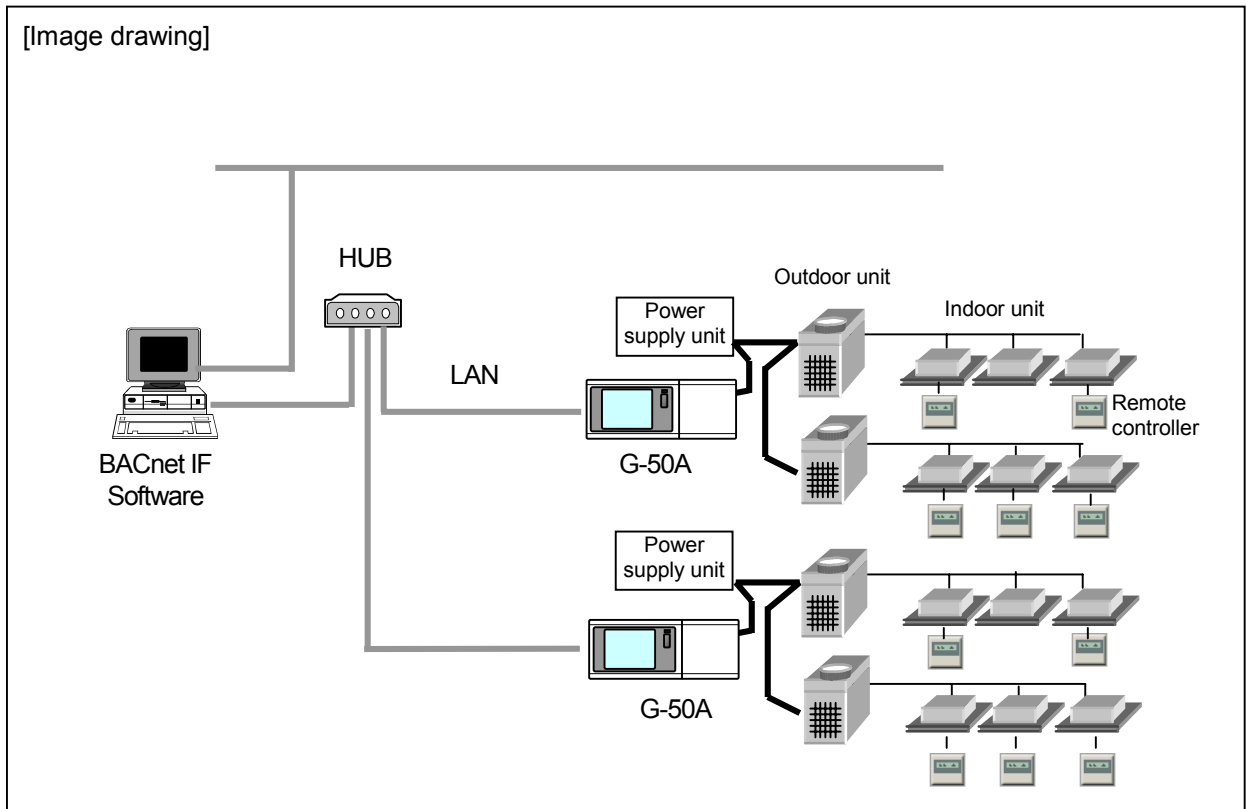

3.2 Hardware Connection Diagram

(1) LAN connection

Connect the LAN cable to the PC. The location of the LAN connector of the PC, refer to the Instruction Manual of the PC.

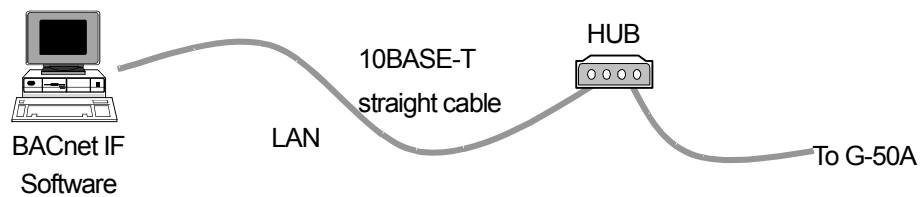

Note:

- Be sure to use the HUB.
- Execute the LAN cascade connection as shown below.
For 10BASE-T, the cascade connection is executable up to a maximum of 4 stages.

3.3 Group Configuration

In BACnet IF, a G-50A number + group number is a unit for management. The instance number of BACnet consists of G-50A number + group number + member numbers. For details, it is "Chapter 4.3 Relation between object and management item" reference. Below, a group number and G-50A number are explained.

- 1) G-50A number
This is set up with a Setting Tool program.
The ranges of the G-50A number are 1-10.
- 2) Group number
Two or more sets IC (Indoor Unit) are set up as one group.
The ranges of the group number are 1-50.
- 3) Member number
This corresponds to each function (operation and monitoring of air conditioning).
The ranges of the member are 1-99.

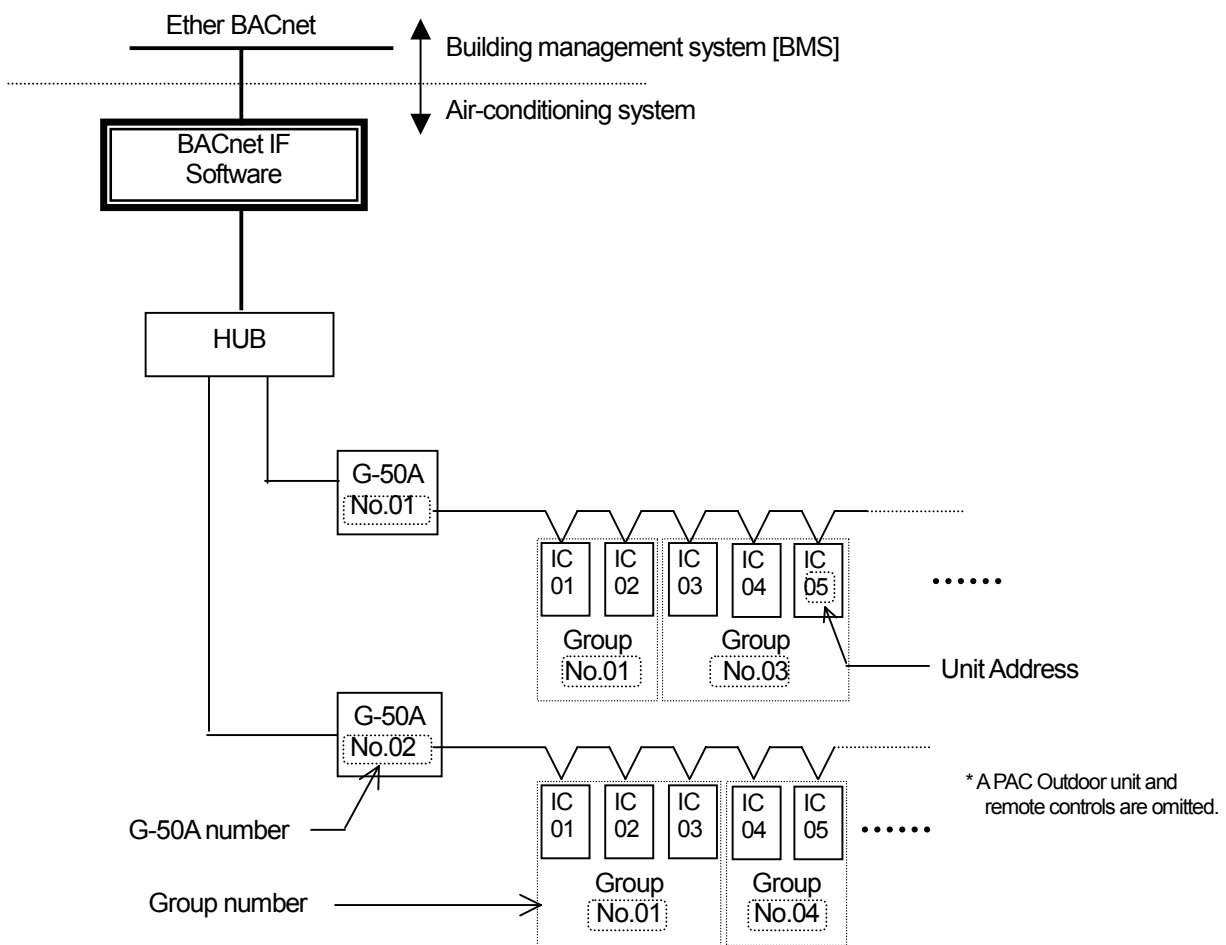

Note:

- G-50A, which can be managed by BACnet IF, is a maximum of 10 sets.
- Indoors unit controllers, which can be managed by G-50A, are a maximum of 50 sets.
- Groups, which can be managed by G-50A, are a maximum of 50 sets.

4.Functional specification

4.1 Communication Protocol Specification

1) Protocol Outline

BACnet/IP which applied to ANSI/ASHRAE 135-1995, 135a, 135b correspondingly on UDP/IP of Ethernet is used.

Ether Header	IP Header	UDP Header	BVLL Header	NPCI of BACnet NETWORK	APDU of BACnet
--------------	-----------	------------	-------------	------------------------	----------------

2) Ether Header

A physical layer sets a transmission medium to 10 BASET by Ethernet.

3) IP Header

The private address of Class C is recommended (*1). Subnet mask 255.255.255.0

*1: Recommendation value (range) [192.168.1.1]~[192.168.254.254]
[192.168.0.0] and [192.168.255.255] do not use it.

4) UDP Header

The default UDP port of a unicast and broadcasting is set to 47808 (0xBAC0).

5) BVLL Header

BVLC type (one octet) 0x81 fixation (BVLL to BACnet/IP)
BVLC function (one octet) 0x0A At the time of a unicast
0x0B At the time of broadcasting
BVLC length (two octets) Arbitrary (wording-of-a-telegram length setup: a big endian specification)

6) NPCI of BACnet NETWORK

Version (one octet) 0x01 Fixation
Control (one octet) 0x04 Those with a response message
0x00 With no response message

7) APDU of BACnet

It has arbitrary lengths of 1024 or less octets. Contents details are ANSI/ASHRAE 135-1995, 135a, 135b references.

8) Application of BACnet

- The instance number of a Device object 3 (Setting change of a instance number is possible)
- Segmentation Transmission and reception are un-supported.
- APDU which can be received 1024 octet
- APDU timeout 3 sec (Setting change of a instance number is possible)
- Vender ID 99
- Process ID blank (Setting change of a process ID is possible)

4.2 Object List

The list of the objects to be used is shown below.

Object type		Support ○: Support ×: Un-supporting	Note
Analog Input	0	○	
Analog Output	1	×	
Analog Value	2	○	
Binary Input	3	○	
Binary Output	4	○	
Binary Value	5	○	
Calendar	6	×	
Command	7	×	
Device	8	○	
Event Enrollment	9	×	
File	10	×	
Group	11	×	
Loop	12	×	
Multi-state Input	13	○	
Multi-state Output	14	○	
Multi-state Value	19	×	
Notification Class	15	○	
Program	16	×	
Schedule	17	×	
Averaging	18	×	
Trend Log	20	×	

4.3 Object and Management Item

Object ID consists of object type + instance number.

An instance number consists of G-50A number + air-conditioner equipment group number + member number.

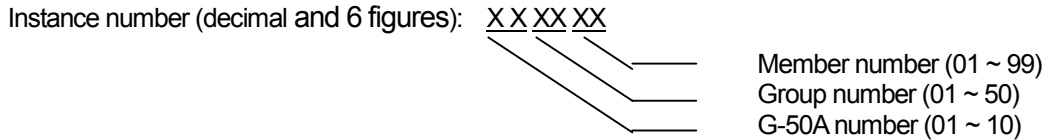
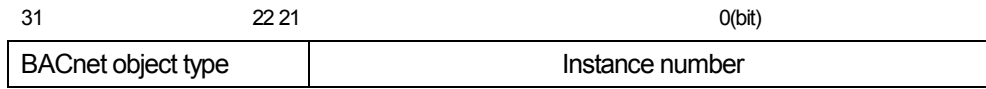

Note: G-50A number: Specify the IP address of G-50A corresponding to G-50A number 1-10, and determine G-50A number.

Object	Object type	Instance number	Management item	Note
On/Off (setup)	Binary Output	xxxx01	Inactive: Off Active: On	
On/Off (state)	Binary Input	xxxx02	Inactive: Off Active: On	
Alarm signal	Binary Input	xxxx03	Inactive: Normal Active: Abnormalities	
Error Code	Multi-State Input	xxxx04	01: Normal 02: Other abnormality 03: Refrigerant system abnormality 04: Water system abnormality 05: Air system abnormality 06: Electric system abnormality 07: Sensor abnormality 08: Communication abnormality 09: System abnormality	
Operation mode (setup)	Multi-State Output	xxxx05	01: Cool 02: Heat 03: Fan 04: Auto 05: Dry *1)	*4)
Operation mode (state)	Multi-State Input	xxxx06	01: Cool 02: Heat 03: Fan 05: Dry *1)	*4)
Fan Speed (setup)	Multi-State Output	xxxx07	01: Lo 02: Hi 03: Mid2 *2) 04: Mid1 *2)	Lo<Mid2<Mid1<Hi
Fan Speed (state)	Multi-State Input	xxxx08	01: Lo 02: Hi 03: Mid2 *2) 04: Mid1 *2)	Lo<Mid2<Mid1<Hi
Room Temp.	Analog Input	xxxx09	°F / °C	*3)
Set Temp.	Analog Value	xxxx10	°F / °C	*3)
Filter Signal	Binary Input	xxxx11	Inactive: OFF Active: ON	
Filter Signal Reset	Binary Value	xxxx12	Inactive: RESET ACTIVE: Void	If it read, the same state, as a Filter Signal will return.
Prohibition of local operation (On/Off)	Binary Value	xxxx13	Inactive: Permit Active: Prohibit	
Prohibition of local operation (Mode)	Binary Value	xxxx14	Inactive: Permit Active: Prohibit	*3)

Object	Object type	Instance number	Management item	Note
Prohibition of local operation (filter reset)	Binary Value	xxxx15	Inactive: Permit Active: Prohibit	
Prohibition of local operation (Set Temp.)	Binary Value	xxxx16	Inactive: Permit Active: Prohibit	*3)
Communication State	Binary Input	xxxx20	Inactive: Normal Active: Abnormalities	
System Forced Off	Binary Value	xx9921	Inactive: Released Active: Effective	
Air direction (setup)	Multi-State Output	xxxx22	01: Horizontal 02: Down 60% 03: Down 80% 04: Down100% 05: Swing	*3)
Air direction (state)	Multi-State Input	xxxx23	01: Horizontal 02: Down 60% 03: Down 80% 04: Down100% 05: Swing	*3)
Notification Class	Notification Class	000003		Setting change of an instance number is possible.
Device	Device	000003		Setting change of an instance number is possible.

*1) It can use, if dry operation use is set up.

*2) It can use, if use of Mid1/Mid2 is set up.

*3) The group of LC serves as an item with an invalid attribute.

*4) As for the operation mode of the group of LC, an attribute serves as ventilation fixation.

4.4 Service List

Service		Initiate	Execute	Note
Acknowledge Alarm	0	x	x	
Confirmed COV Notification	1	○	x	
Confirmed Event Notification	2	○	x	
Get Alarm Summary	3	x	x	
Get Enrollment Summary	4	x	x	
Subscribe COV	5	x	x	
Unconfirmed COV Notification	28	○	x	
Unconfirmed Event Notification	29	○	x	
Atomic Read File/Atomic Write File	6/7	x	x	
Add List Element	8	x	x	
Remove List Element	9	x	x	
Create Object/Delete Object	10/11	x	x	
Read Property	12	x	○	
Read Property Conditional	13	x	x	
Read Property Multiple	14	x	○	
Write Property	15	x	○	
Write Property Multiple	16	x	○	
Read Range	35	x	x	
Device Communication Control	17	x	x	
Confirmed Private Transfer	18	x	x	
Unconfirmed Private Transfer	30	x	x	
Reinitialize Device	20	x	x	
Confirmed Text Message	19	x	x	
Unconfirmed Text Message	31	x	x	
Time Synchronization	32	x	○	
UTC Time Synchronization	36	x	x	
Who-Has	33	x	○	
I-Have	27	○	x	
Who-Is	34	x	○	
I-Am	26	○	x	
Vt-Open/Vt-Close/Vt-Data	21/22/23	x	x	

Initiate :Issue of service

Execute: Reception and execution of service

4.5 Service list for every object

Service transceiver list for every object is shown below.

INIT : BACnet IF transmits.
 EXEC : BACnet IF receives.

		Device	Analog Input	Analog Output	Analog Value	Binary Input	Binary Output	Binary Value	Multi-State Input	Multi-State Output	Multi-State Value	Notification Class	Note
Time Synchronization	INIT												
	EXEC	○											
I-Am	INIT	○											
	EXEC												
Who-Is	INIT												
	EXEC	○											
I-Have	INIT	○											
	EXEC												
Who-Has	INIT												
	EXEC	○											
Confirmed COV Notification	INIT		▲		▲	▲	▲	▲	▲	▲			
	EXEC												
Confirmed Event Notification	INIT		▲		▲	▲	▲	▲	▲	▲			
	EXEC												
Unconfirmed COV Notification	INIT		▲		▲	▲	▲	▲	▲	▲			
	EXEC												
Unconfirmed Event Notification	INIT		▲		▲	▲	▲	▲	▲	▲			
	EXEC												
Read Property	INIT												
	EXEC		○		○	○	○	○	○	○			
Read Property Multiple	INIT												
	EXEC		○		○	○	○	○	○	○			
Write Property	INIT												
	EXEC				○		○	○		○			
Write Property Multiple	INIT												
	EXEC				○		○	○		○			
Add List Element	INIT												
	EXEC												
Remove List Element	INIT												
	EXEC												

○ : Standard support ▲ : Setting change is possible.

4.6 Event Service specification

It is shown whether Event Notification of each object is carried out or it does not carry out.

Event is used for the notice of Alarm. COV is used for announcement at the time of change of Present_Value.

Selection of Confirmed and Unconfirmed presupposes that it is possible for every notification point.

Object	Object type	Event	COV	Note
On/Off (setup)	Binary Output	○	○	
On/Off (state)	Binary Input	○	○	
Alarm signal	Binary Input	○	○	
Error Code	Multi-State Input	○	○	
Operation mode (setup)	Multi-State Output	○	○	
Operation mode (state)	Multi-State Input	○	○	
Fan Speed (setup)	Multi-State Output	○	○	
Fan Speed (state)	Multi-State Input	○	○	
Room Temp.	Analog Input	○	○	
Set Temp.	Analog Value	○	○	
Filter Signal	Binary Input	○	○	
Filter Signal Reset	Binary Value	○	○	
Prohibition of local operation (On/Off)	Binary Value	○	○	
Prohibition of local operation (Mode)	Binary Value	○	○	
Prohibition of local operation (filter reset)	Binary Value	○	○	
Prohibition of local operation (Set Temp.)	Binary Value	○	○	
Communication State	Binary Input	○	○	
System Forced Off	Binary Value	○	○	
Air direction (setup)	Multi-State Output	○	○	
Air direction (state)	Multi-State Input	○	○	
Notification Class	Notification Class	-	-	
Device	Device	-	-	

○ : Standard support -: No support

4.7 Function

BACnet IF provides the gateway of the communication between air conditioners and BACnet.

The instructions from a building management system are changed and it sends an air conditioner side (G-50A).

Moreover, the state by the side of an air conditioner (G-50A) is polled, state change is caught, and it sends a building management system.

A surveillance item is "4.3 Relation between object and management item" reference.

4.8 Setting functional list

The list of the setting functions of BACnet IF is arranged below.

Chapter 8 explains the usage of each function.

Setting information takes backup. For the backup procedure, refer to Appendix 3.

Item		Details	
G-50A Tab		G-50A and the air-conditioning unit for management are set up. (*1)	
	G-50A setup	The information on G-50A for management is set up. G-50A number, IP address, Port number (80 fixation : for LAN communication of G-50A).	
	Group setup	The information on the group registered into G-50A is set up. Group number, Apparatus attribute, Out Of Service	
BACnet Tab		It sets up about BACnet communication.	
	Broadcast IP-Address	The IP address of a building management system is set up.	
	Timeserver IP-Address	The IP address of time synchronous origin is set up.	
	BACnet Application setup	The communication parameter of BACnet is set up. Port number (47808 fixation: for BACnet communication), Venders ID (99 fixation), DeviceID APDU timeout, Number of times of APDU retries, Check command (I-AM) transmitting interval	
	Event Notification setup	Notification function is set up.	
		COV Notification	COV number, IP address, Notification type
		EVENT Notification	Processes ID, NClassID, Priority, IP address, Notification type
		Conditions of Notification	COV Notification: COV number, Change increment setup EVENT Notification : NClassID, Event-Enable, Limit-Enable, Notification type, Time_Delay
System Tab		The function of a system is set up.	
	Unit of Temperature	The unit (Fahrenheit, Celsius) of the temperature data used by BACnet is switched.	
	Drive Mode Type	Use in operation mode "DRY" is set up.	
	Air Speed Type	Use of wind velocity "Mid2, Mid1" is set up.	
	Time Set	The notification to G-50A of a time synchronous notification is set up. (*2)	
	Auto Reboot	The execution time of automatic reboot is set up.	
File menu		Execution of file operation and an end of a tool.	
	New Settings	An untitled setting file is newly created.	
	Open Settings	System information is loaded from the saved file.	
	Save Settings	System setting information is saved at a file (overwrite).	
	Save Settings As...	System setting information is saved at a file.	
	Exports	System setting information is outputted to a CSV file.	
	Properties	The IP address of the personal computer, which is setting up BACnetIF, is set up. [127.0.0.1] is set up when BACnetIF is set up in the same personal computer as a setting tool.	
	Exit	A setting tool is ended.	
BACnetIF menu		The contents of a system setting are transmitted between SetBACnet (setting tool) and BACnetIF.	
	Get Settings	System setting information is transmitted to BACnetIF.	
	Put Settings	System setting information is read from BACnetIF.	

*1 Since the information on the set-up air-conditioning unit is not registered into G-50A, it is necessary to set it up on G-50A separately.

*2 Setup of "Timeserver IP-Address" is required for use of this function.

5. Installation

5.1 Pre-installation Steps

Preparing for installation

Before installing BACnet IF program, do the following checks and preparatory steps.

Steps	Action	Details	How to
1	Check the OS	Check the OS Service Pack version -WindowsXP Professional:SP1and above	* If not the correct version, upgrade to the correct version.
2	Check the memory	Check that there is at least 256MB of RAM	* If necessary, add more RAM
3	Check the HDD free space	Check that there is at least 2GB of free space on the C drive. (OS already set up)	* Refer to the Windows instruction manual for more details.
4	Set the date and time	In the Windows Control Panel, select "Date and time" and set the date, time and region	* For details, refer to the Windows users manual.
5	Screen size and color settings	At the "display" in the Windows Control Panel, set the screen size to 1024x768 or larger and the color to 65536 colors (High Color (16bit)) or more.	* For details, refer to the Windows users manual.
6	Automatic login settings	When automatic reboot is set up, please check automatic LOGIN of WindowsXP, and automatic starting of BACnet IF. *1	* For details, refer to the Windows users manual.
7	Network settings	Check that the network settings have been performed.	* For details, refer to the Windows users manual.
8	Check the Power options condition	In the Windows Control Panel, select "Performance and Maintenance-Power options" and check that both "System stand-by" and "system hibernates" have been set to "Never". *2	* For details, refer to the Windows users manual.

*1:Automatic login sets the automatic start-up without entering the login name or password at the OS start-up. In a setup to reboot, make it a setup, which carries out automatic login.

*2:Please make it a setup to which BACnet IF can always operates for 24 hours.

Notes:

- Be sure to log-in to Windows, using the Auto log-in name and password before executing that set-up. (It is necessary execute the log-in with a log-in name having administrator rights)
- The BACnet IF will not be started automatically after starting (rebooting) the PC.
- When the BACnet IF is set to Auto reboot, unless the Automatic login is set. When the BACnet IF is set to Auto reboot, be sure to set the Automatic login.

5.2 BACnet IF Setup

This section describes how to set up BACnetIF and a setting tool (SetBACnet).

(1) CD-ROM directory structure

The folder composition of the setup disk (CD-ROM) of BACnet IF is shown.

[CD-ROM drive]	/BACnetIF	:Set-up folder for BACnet IF
	/SetBACnet	:Set-up folder for Setting Tool

(2) Starting the setup program

Please click and start "SETUP.exe" in CD-ROM.

If there is no problem with cautions, click the [Next] button to continue on the next screen.

* Click the [Cancel] button to stop the setup.

Setup Program;	
BACnet IF	:¥BACnetIF¥ setup.exe
Setting Toll	:¥SetBACnet¥setup.exe



(3) Read the software license agreement

The license agreement screens will be displayed one at a time. Carefully read all of the agreement and check that you agree with each item and clicking [Yes] to continue.

*If you cannot agree with the license agreement, click the [No] button and stop the installation of BACnet IF.

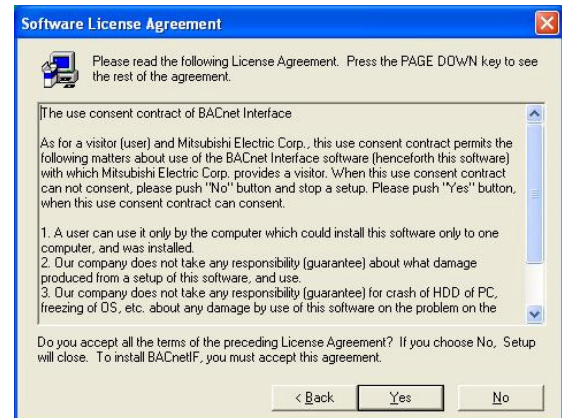

(4) Setup the serial No.

Check a user's Name and Company name.

The name set up at the time of a Windows XP setup is displayed.

The serial number inputs the following numbers and Clicks a [Next] button.

Serial Number;	
BACnet IF	: BACNET-IF
Setting Tool	: SET-BACNET

* Click the [Cancel] button to stop the installation.

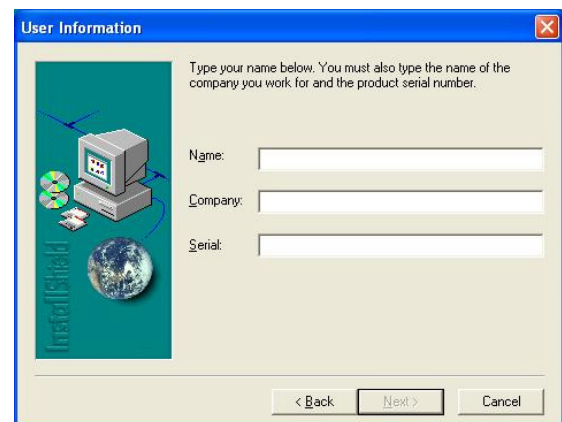

(5) Check the installation folder

Check the location where the program is to be installed. If the location needs to be changed, set the new location by clicking the [Browse] button.

After checking the installation location, click the [Next] button.

* Click the [Cancel] button to stop the installation.

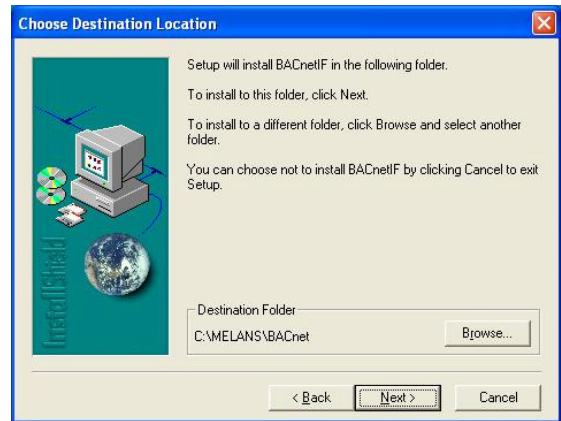

(6) Check the program folder

Check the program folder name that registers the BACnet IF program into the start menu. When using the existing folder name, it can choose from a list. If the [Next] button is clicked the installation will start.

* Click the [Cancel] button to stop the installation.



(7) Setup completion

Click the [Finish] button on the Setup Complete screen.

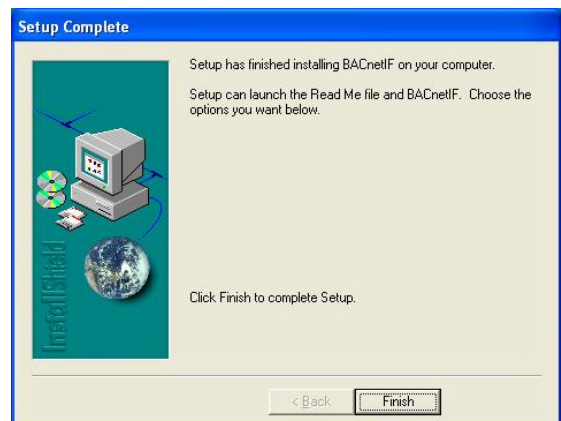

(8) Setup completion

After the installation is completed, set the program into the start menu. The program runs automatically from the next time the PC is started. [Program to register]

The following files are included in the installation folder specified in Procedure 1.

- BACnetIF.exe : BACnet IF program
- XmlSvr.exe : XML Server

After the installation is completed, restart the PC.

Note

Be sure to restart the PC after installing BACnet IF. Store the CD-ROM in a safe place.

5.3 BACnet IF Uninstall

This section describes how to uninstall “BACnet IF” and “Setting Tool (SetBACnet)” program.

(1) Uninstall

- 1) Check to see if the BACnet IF has ended
Check to see if the BACnet IF and XmiSvr have ended, if it has not ended, end it.
* For a description of the ending method, see Chapter 7.3
- 2) Start “Add/Remove Programs”
Start by clicking Control Panel’s Add/Remove Programs.
- 3) Select [BACnetIF], and click [Change/Remove] button.
Uninstallation of the BACnet IF program begins.

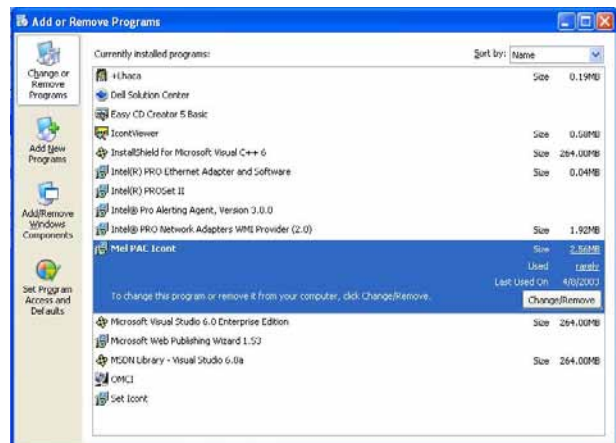

Note

- We recommend that you do not delete all the shared files.
- This uninstall cannot delete some folders and files.

- 4) “Add/Remove Programs” ending
When program uninstallation ends, Add/Remove Programs ends.

6.Part Names and Functions

6.1 Window Elements

The icon is displayed on the taskbar by the completion of starting of BACnet IF program.
Click the BACnet IF icon on a taskbar with the light button of a mouse. A pop up will appear.

(1) Show Window

Select the [Show Window] on a pop up menu. BACnet IF screen will open.

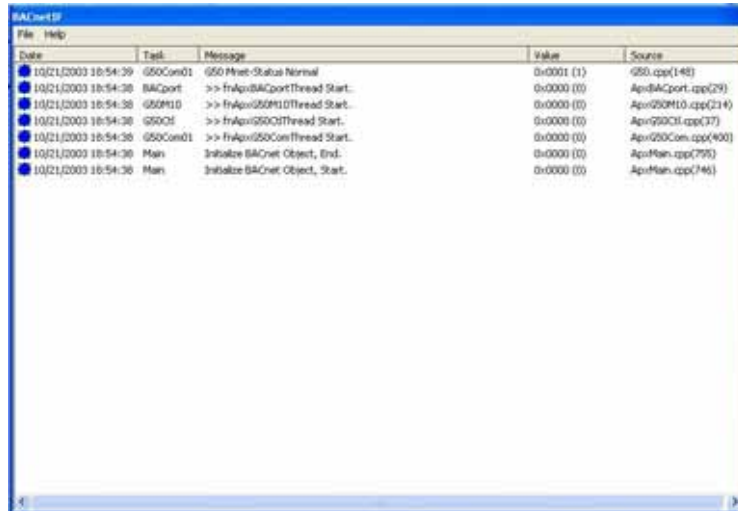

Note:

It is not necessary to open the window except the case of maintenance or a test run.

(2) Hide Window

Select the [Hide Window] on a pop up menu. BACnet IF screen will close.

Note:

BACnet IF is not ended even if the Window closes.

6.2 Basic Mouse Operation

First, use of the mouse, as a pointing device will be explained. If a device other than a mouse is being used, consult with the manual for that device.

The following is a list of term used in describing mouse operations.

Item	Details
Click	This refers to pressing and releasing the button one time. To use this function, click the button.
Double Click	This refers to pressing and releasing the button twice in quick succession.
Drag	This refers to moving the mouse pointer on top of an object on the screen, pressing and holding down the button to select the object, then, while holding the button down, moving the mouse pointer, and the object, to a different location.
Keyboard	Primarily used when entering password, characters, or numeric.

7. Initial Startup and Shutdown

7.1 Before Startup

Before starting BACnet IF program, do the following checks.

No.	Item
(1)	A test run of the air conditioning system has been completed.
(2)	Check that the personal computer, HUB, G-50A, power supply unit, and air conditioner power are turned on.
(3)	All PC hardware and cables have been connected and the proper software installed.
(4)	"Date and time" setting are correct
(5)	All items are set up with the setting tool (Set BACnet software).

7.2 Start up

Turn on the PC (or restart the Windows OS)



Windows OS reboots and the user automatically logs in Windows. (*1)



BACnet IF program starts. (*2)



The icon is displayed on the taskbar at the lower right of a screen by the completion of starting of BACnet IF program.



*1 It is the case where a setup that logs in automatically is carried out. → Refer to Appendix 1

*2 Logged in Windows; BACnet IF will be started automatically. Moreover XmlSvr (XML Server) is also started.

7.3 Shutdown

- 1) Click the BACnet IF icon on a taskbar with right button of a mouse. A pop up menu will appear. Select the [Show Window] on a pop up menu. BACnet IF screen will open.



*1 When the BACnet icon is not displayed on the taskbar, please start "Task Manager" of Windows and end a program.

- 2) Click the BACnet IF screen on a taskbar with left button of a mouse. A pop up menu will appear.

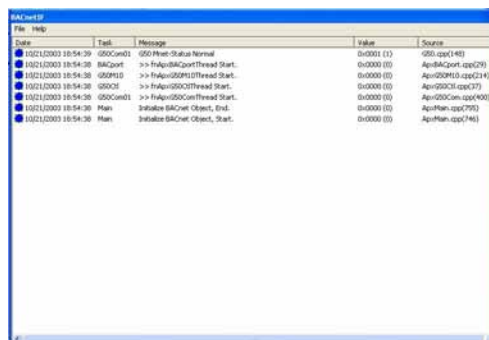

- 3) Push [Alt] and [F4] buttons. The confirmation screen will open.



- 4) Click the [Yes] button. The confirmation screen will open again.



- 5) Click the [Yes] button. The [Now Closing] dialog box is displayed for several seconds.



- 6) Shut down the Windows, after the BACnetIF end.
7) Turn off the PC and Display, after the Windows end.

Note

- Refer to each operating manual about the details of the shutdown method of Windows and a PC.

8. System Setting Procedure

Setting Tool [SetBACnet] is the program that sets up the function and system configuration of BACnet IF. Please restart BACnet IF, if Setting Tool sets up the function and system configuration of BACnet IF. (BACnet IF reads the function and system configuration at the time of starting)

8.1 Start Up [SetBACnet]

- 1) Select the [SetBACnet] in the start menu.



Perform the system setup, after Setting Tool starts. Refer to Chapter 8.3 after starting.

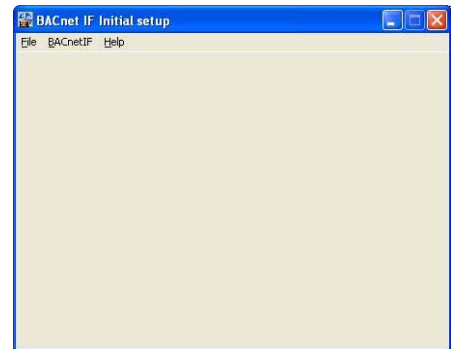

8.2 Shutdown [SetBACnet]

- 1) Select the [Put Setting] in the [BACnetIF] menu. System setting data is sent to BACnet IF. Select the [Save Settings] in the [File] menu, if setting data is saved at a file.

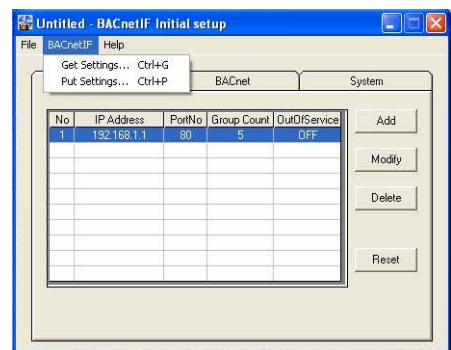

- 2) Select the [Exit] in the [File] menu. Setting Tool is ended.

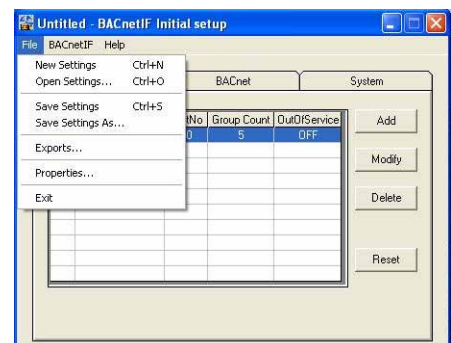

Note:

- Please restart BACnet IF, when a function and a system configuration are changed.
- BACnet IF reads setting information at once at the time of starting.

8.3 Windows Elements

The initial setup screen of SetBACnet is shown below.

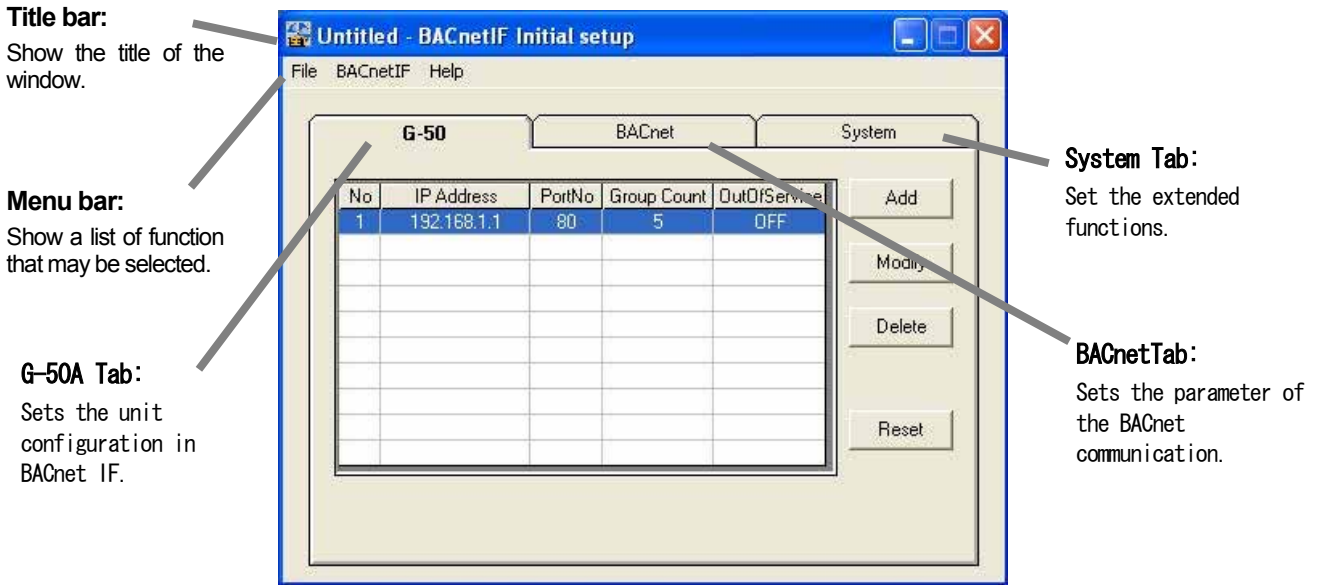

8.4 Open/Close file

The File menu contains items that allow you to start creating a file, save changes in your system setting, and exit BACnetIF. The made file is used for the backup of the system etc.

[File] menu	Contents
[New Settings]	Open a new empty file
[Open Settings]	Open a pre-existing file
[Save Settings]	Save the current file (*.dat) If you have not edited the file since you last saved, then a new empty file will appear in the Main Window. If you have edited the file since you last saved, then dialog boxes will open prompting you to save the changes.
[Save Settings As]	Save the current file under a new file name (*.dat) The dialog box with a suggested file name will appear.
[Exports]	Export is done to the CSV file.
[Properties]	IP address of PC to which BACnetIF is set up is input. [127.0.0.1] is input when set up to PC, as which BACnetIF and a setting tool are the same.
[Exit]	THE BACnetIF program is ended.

8.5 Get/Put system settings

The [BACnetIF] menu contains the item that you forward the system set up information to BACnetIF, and acquires it from BACnetIF.

[BACnetIF] menu	Contents
[Get Settings]	The system set up information is acquired from BACnetIF. (*1)
[Put Settings]	The system set up information is forwarded to BACnetIF. (*1, *2)

*1 Internet Protocol address at the forwarding destination (acquisition source) is set with Properties of the File menu.

*2 Please restart BACnetIF, when a function and a system configuration are changed.

BACnet IF reads setting information at once at the time of starting.

8.6 System Setting Procedure

The following is an explanation of the System Settings performed at Setting Tool.

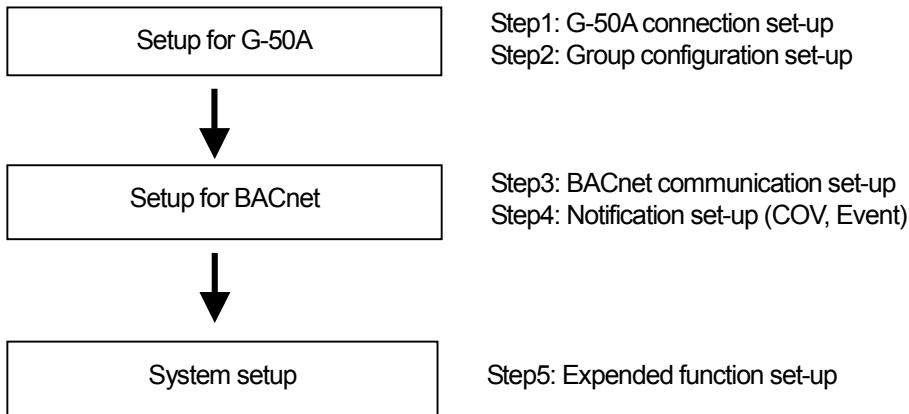

8.7 Setup for G-50A

Set the information of the air-conditioning system.

8.7.1 Register the G-50A

Select the [G-50] Tab. G-50A registered is displayed on a screen. G-50A, which can be registered, is to ten sets.

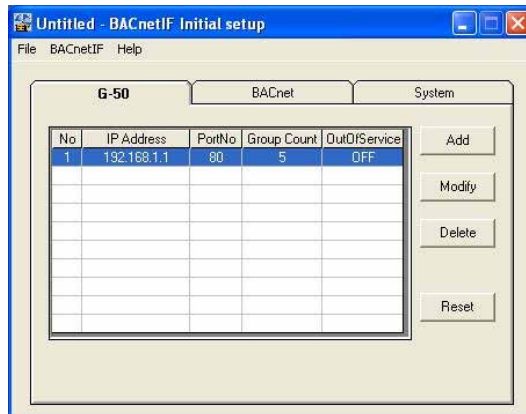

(1) Add G-50A

Click the [Add] button. The [G-50] window will open →Refer to 8.7.2 and 8.7.3

(2) Modify G-50A setting

Select the [No.] of G-50A. And click the [Modify] button. The [G-50] window will open. → Refer to 8.7.2 and 8.7.3

(3) Delete G-50A

Select the [No.] of G-50A. And click the [Delete] button. The confirmation screen will open.

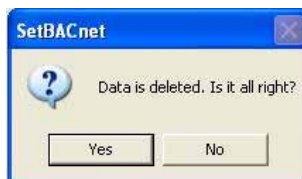

(4) Reset data

Click the [Reset] button. The confirmation screen will open.

8.7.2 G-50A NO. and IP-Address

Set the number and IP-Address of G-50A connected to the system.

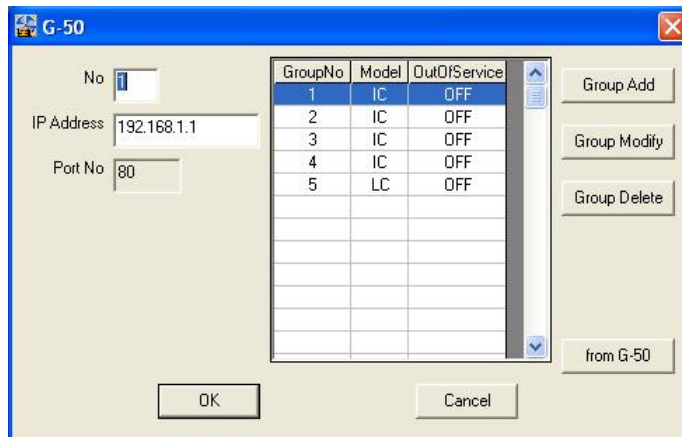

Item	Contents	Set value
No. (G-50A No.) *1	Set the number of G-50A connected to the system.	Default: Null Range: 1 to 10
IP Address	Input an IP address of the G-50A. *2	Default: [192.168.1.1]
Port No	It is communication port number.	It is fixed to 80.

*1: We recommend setting up the number of G-50A so that it may not overlap, when two or more BACnet IF is being used.

*2: Refer to the operating manual of G-50A about the method of setting an IP address as G-50A.

8.7.3 Add/Modify/Delete Group

Set the group configuration connected to the G-50A.

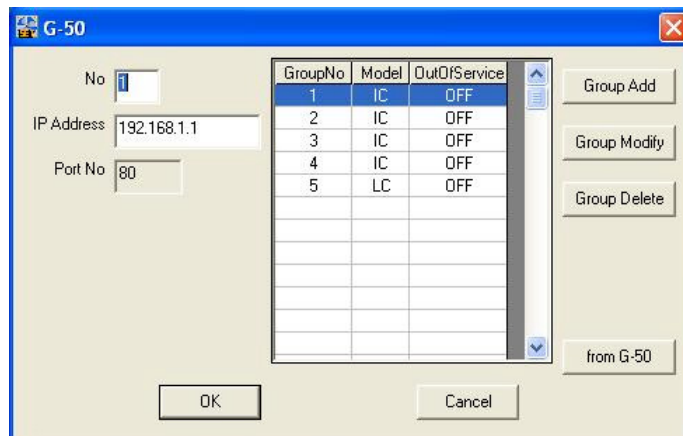

(1) Add group

Click the [Group Add] button. The [G-50] window will open.

→Refer to 8.7.4

(2) Modify group configuration

Select the [Group No.]. And click the [Group Modify] button.
The [G-50 Group] window will open. →Refer to 8.7.4

(3) Delete group

Select the [Group No.]. And click the [Group Delete] button.
The confirmation screen will open.

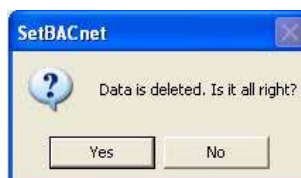

(4) from G-50A

Click the [from G-50] button. The confirmation screen will open.
 Click the [YES] button acquires group information from G-50A.



Note:

Separately, it is necessary to register groups into G-50A.

8.7.4 Group setup

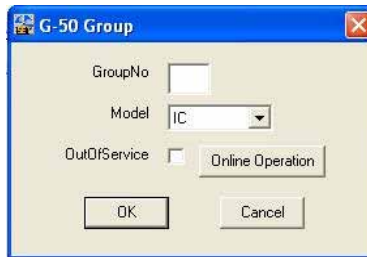

8.7.4.1 Group Setup

Item	Contents	Set value
Group No	Input the number of a group.	Default: Null Range: 1 to 50
Model	Select the model of a group.	IC:Indoor unit LC: LOSSNAY unit OA processing unit: select IC
Out Of Service *1	If the service mode of the group is changed into OutOfService, the communication message about the group will be transmitted to neither G-50A nor a BMS.	Default: Off Check mark is Off: Service mode Check mark is On: OutOfService mode

*1:Out Of Service in the case of maintenance or a test run.

<Communication Message>

From BMS : The instruction (System Forced OFF is excluded) from BMS is not transmitted to G-50A.

Monitoring for G-50A : Neither state change nor abnormality of the air-conditioning unit is notify.

<Change Timing>

After ending BACnetIF, with [OutOfService] checked, a setup is reflected at the time of next BACnetIF starting.

If [OutOfService] is checked and the [Online Operation] button is clicked, it will be immediately reflected in BACnetIF. →Refer to 8.7.4.2

Note:

Be sure to release OutOfService mode after maintenance or a test run.

8.7.4.2 Online Operation

Click the [Online Operation] button. The confirmation screen will open.
 If it will be immediately reflected in BACnet IF, click the [True] button.
 Click the [False] button, when that is not right.

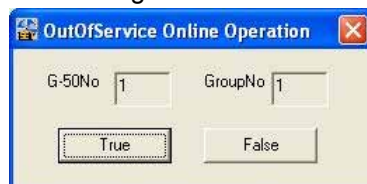

8.8 Setup for BACnet

BACnet communication is set up.

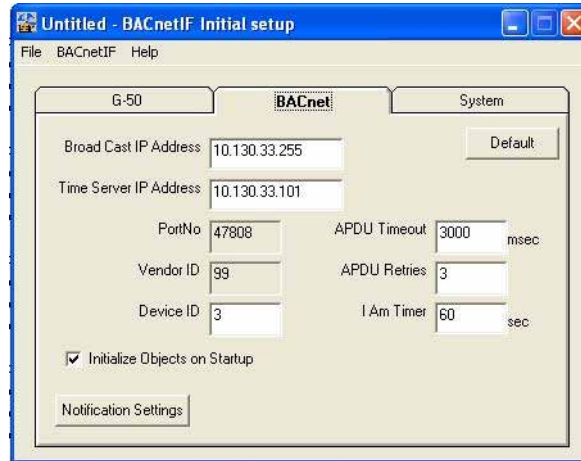

8.8.1 Communication setup

Item	Contents	Set value
Broad Cast IP Address	Input the IP address of the BMS. This is the destination address of a notification message to BMS. It is used when set as [use COV/EVENT notify] and [Unconfirmed]. This is the destination address of a check message (I Am Service).	Initial value: 192.168.1.255 The setting range of four numerical values divided by "." is 1 to 255. Set a right end numerical value to 255 among four numerical values. (255 is assigned to broadcasting) *1
Time Server IP Address	Input the IP address of the TimeSynchronization server. BACnet IF receives only the TimeSynchronization message that transmitted from this address.	Initial value: Null The devices, which communicate on BACnet makes a network address the same setup.
Port No	This is the BACnet port number.	It is fixed to 47808.
Vender ID	Vendor ID	It is fixed to 99.
Device ID	Device ID on BACnet communication.	Initial value: 3 Range: 1 to 4194303
APDU Timeout	This property shall indicate the amount of time between retransmissions of APDU.	Initial value: 3000msec Range: 0 to 99999 msec
APDU Retries	This property shall indicate the maximum number of times that an APDU shall be retransmitted.	Initial value: 3 Range: 0 to 99
I Am Timer	[I Am] service is a check message. [I Am Timer] is the interval of the check message, which BACnet IF sends to BMS.	Initial value: 60 sec Range: 0 to 999 sec If "0" is set up, BACnet IF does not send a check message.
Notification Settings	A detailed setup of Notification.	The [Notification Setting] screen opens. →Refer to Chapter 8.8.2 (Notification Setting)
Initialize Objects on Startup	All objects are initialized when starting BACnetIF. Each item becomes the value set up with the setting tool (SetBACnet).	Initial setting: Not initialize. Check Off: Not initialize. Check On: Initialized
Default	The value is reset to a default value.	

*1: The initial value is a broadcast address in a gateway.

8.8.2 Notification Setting

BMS carries out the monitor of the state, in order to know the state of Object of BACnetIF. Notification is the function notified to the BACnet (or Building Automation System), when the value currently supervised exceeds a limit or it changes to an alarm value. There are COV type and EVENT in Notification.

Item	Contents	Target object name
COV (Change Of Value) Notification	Example) When the [RoomTemp] value currently supervised changes, BACnet IF send a COV notification message to the BMS.	All Except for Notification Class and Device
EVENT Notification	When the decided specific conditions are satisfied, it announces to a BMS. Example1) When the [Alarm Signal] value currently supervised changes to the alarm value, BACnet IF send a notification message to the BMS. Example 2) When the [RoomTemp] value currently supervised exceeds a limit, BACnet IF sends a notification message to the BMS.	All Except for Notification Class and Device

8.8.2.1 COV notification setup

The destination address of a COV notification message is setup.
The number of the address, which can be registered, is to 10.

Select the [COV Notification Settings] tab.

COV No.
Set the number of COV notification.

(1) Add COV notification address

Click the [Add] button. The [Notification Address] screen will open.

(2) Modify notification address

Click the [Modify] button. The [Notification Address] screen will open.

(3) Delete notification address

Click the [Delete] button. The confirmation screen will open.



Item	Contents	Set value
IP Address	Input the IP address to notify.	The devices, which communicate on BACnet makes a network address the same setup.
Process Identifier	The number, which discriminates a notification setting.	Initial setting: Blank (no setting) Range: 1 to 99999999
Notification Type	Event not notifications may be specified to use either confirmed or unconfirmed services for notification messages.	Unconfirmed: BACnet IF does not wait for acknowledgement (response) of the notification message. Confirmed service: BACnet IF waits for acknowledgement (response) of the notification message.

8.8.2.2 EVENT Notification Setting

The notification class and address of EVENT notification, and setting the parameter of notification. Notification Class ID can specify a maximum of 10 ID and a maximum of 10 addresses for every Notification Class ID. Select the [Event Notification Settings] tab. The [Notification Setting] screen will open.

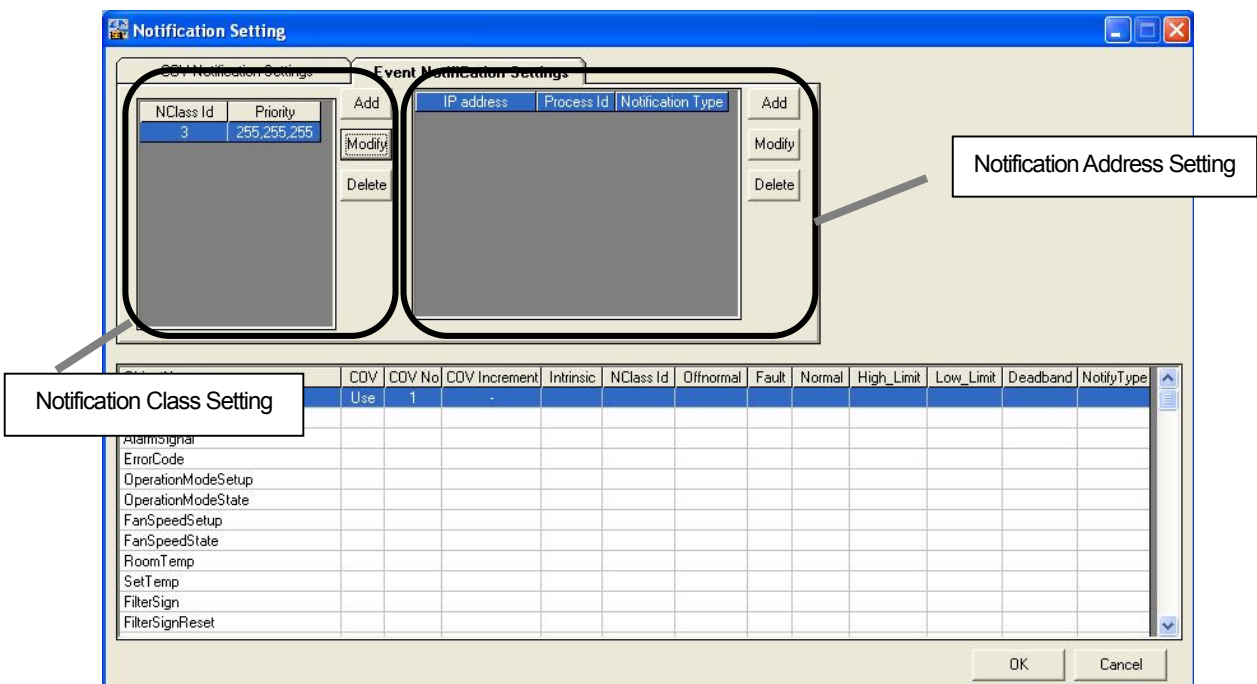

Notification Class Setting

Notification Class is set up for every Notification Class.

(1) Add notification class

Click the [Add] button. The [Notification Class] screen will open.

(2) Modify notification address

Click the [Modify] button. The [Notification Address] screen will open.

(3) Delete notification address

Click the [Delete] button. The confirmation screen will open.

Item	Contents	Set value
NClass ID	Input the Notification Class ID.	Initial setting: 3 Range: 1 to 4194303
Priority	A priority is set up for 3 kinds of events (status change). The smaller value of a priority is higher.	Initial setting: 255 Range: 1 to 255

Notification Address Setting

Notification address is set up for every Notification Class.

(1) Add notification address

Click the [Add] button. The [Notification Address] screen will open.

(2) Modify notification address

Click the [Modify] button. The [Notification Address] screen will open.

(3) Delete notification address

Click the [Delete] button. The confirmation screen will open.

Item	Contents	Set value
IP Address	Input the IP address to notify,	The devices, which communicate on BACnet makes a network address the same setup.
Process Identifier	The number, which discriminates a notification setting.	Initial setting: Blank (no setting) Range: 1 to 99999999
Notification Type	Event not notifications may be specified to use either confirmed or unconfirmed services for notification messages.	Unconfirmed service Confirmed service

8.8.2.3 Notification setting parameter

Double-click the target Object Name. The detail-setting screen will open.

Item	Contents	Target object name *1
Use COV	It checks, using COV notification.	All
COV No	Input the using COV notification number (1 to 10).	
COV Increment	If the range of change exceeds the [COV increment], BACnet IF notifies BACnet (BMS) of COV.	RoomTemp, SetTemp only
Use Intrinsic	It checks, using the intrinsic notification	All
Notification Class Id	Input the using NClass ID.	
Event-Enable	Select the target events (status change) of notification. The 3 kind of event (status change) is [To-Offnormal], [To-Fault], and [To-Normal]	All The check of [To-Offnormal] removes a setup of [On/OFF (state)] In a setup of [ON/Off (state)], the check of [To-Offnormal] is surely removed.
Limit-Enable	BACnet IF notifies BACnet (BMS) when the value exceeds the High_Limit or Low_Limit. Set up the value of high_limit, low_limit, and dead band if needed.	RoomTemp, SetTemp only
Notify Type	Select the notification type Alarm/Event.	All
Time_Delay	When there is no response from G-50A even if delay time passes after BACnet IF sends a message to G-50A, BACnet IF notifies to BACnet (BMS) that message transmission went wrong. The value is fixed to 60 seconds.	(A setup cannot be changed.) OnOffSetup OperationModeSetup FanSpeedSetup AirDirectionSetup

*1 The function, which can be set up changes with target objects.

8.9 System Setup

The extended function of a system is set up.

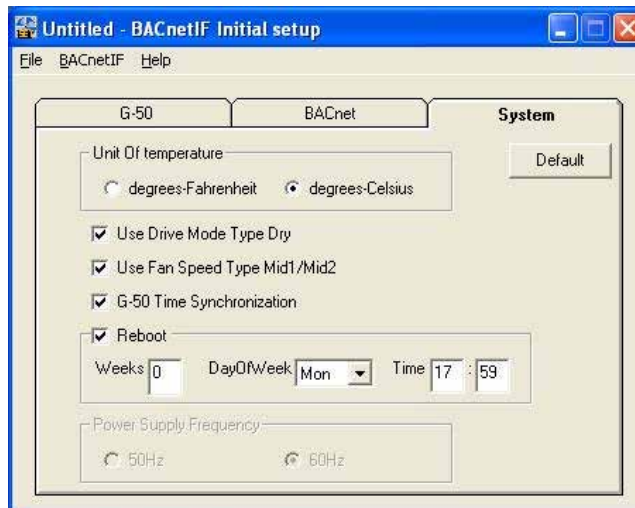

Parameter	Contents	Value
Unit Of temperature	It is on BACnet communication and is the temperature unit to be used.	Initial setting: degrees-Fahrenheit (°F) Select item: degrees-Fahrenheit (°F) / degrees-Celsius (°C)
Use Drive Mode Type Dry	It checks, when using operation mode type "Dry"	Initial setting: Not used the Dry mode Check Off: Not used the Dry mode. Check ON: Used the Dry mode
Use Speed Type Mid2/Mid1	It checks, when using air speed type "Mid2" and "Mid1".	Initial setting: Not used Mid2/Mid1 Check Off: Not used Mid2/Mid1 Low < High Check ON: Used Mid2/Mid2 Low < Mid2 < Mid1 < High
G-50 Time Synchronization	If BACnet IF receives the TimeSynchronization message from BMS when it is checked, the date and time will be transmitted to G-50A. When it check, set the date and time to G-50A, When using this function, be sure to set the "Time Server IP Address".	Initial setting: Not set the data to G-50A Check Off: Not set to G-50A Check On: Set to G-50A
[Automatically] Reboot *1	It checks, when using the automatically reboot. When automatic reboot was set to On, it reboots automatically at the day of the week and time, which are the set-up cycle and were set up.	Initial setting: Not auto reboot (Recommendation) Check Off: Not auto reboot Check On: Automatically reboot Parameter range [Week] 0 to 99 weeks [Day of Week] SUN, MON, ... , SAT [Time] Time (00 to 23) Minute (00 to 59)

*1 When automatic reboot is set up, please set up the automatic login of Windows XP, and automatic starting of BACnet. When a BACnet IF is started automatically, set the program into the start menu.

Note:

- "G-50 Time set" is not performed when using "Energy monitoring function (Activate)" or "Summer Time Set-up (Activate)" by Integrated centralized control software TG-2000A.
- When Windows XP OS is used continuously without restarting, system errors may accumulate. Thus it is necessary to restart both BACnet IF and the OS.
- The automatic restart function serves to insure that the system restart is done on a regular basis. If there is an error during the automatic restart, the system must be restarted manually. Since there is a possibility of the error not being detected, it is recommended to periodically restart the system manually.
- When automatic reboot is set to [ON], Windows reboots automatically with the set-up cycle.
- During starting of BACnet IF, abnormalities may be detected by BAS. Therefore, please carry out after contacting an administrator, in case it works.

9. Site Adjustment

9.1 Site Adjustment

When the task of site adjustment is subdivided into smaller tasks as shown in the figure below, the tasks can be broadly grouped into 3 steps. The benefit of following these 3 steps when carrying out the tasks of site adjustment is that if troubles do arise, it will be clear which step caused the problem. This makes it easier to solve problems and these results in a more efficient execution of site adjustment tasks.

Carry out site adjustment, by following the step-by-step instructions shown below.

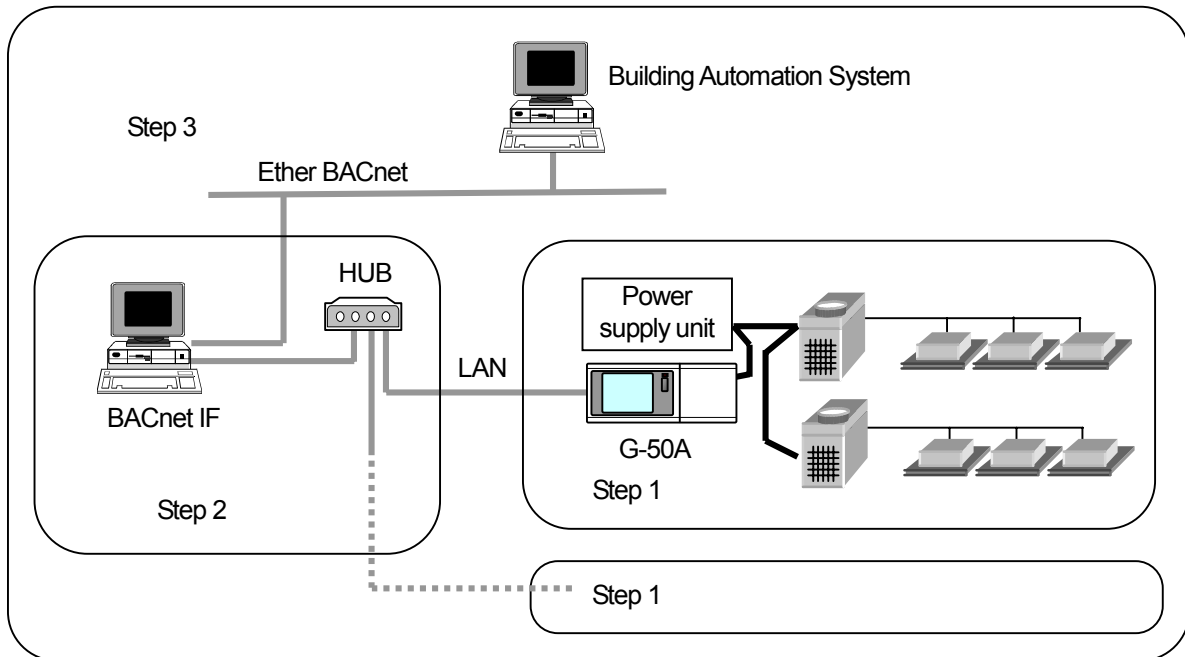
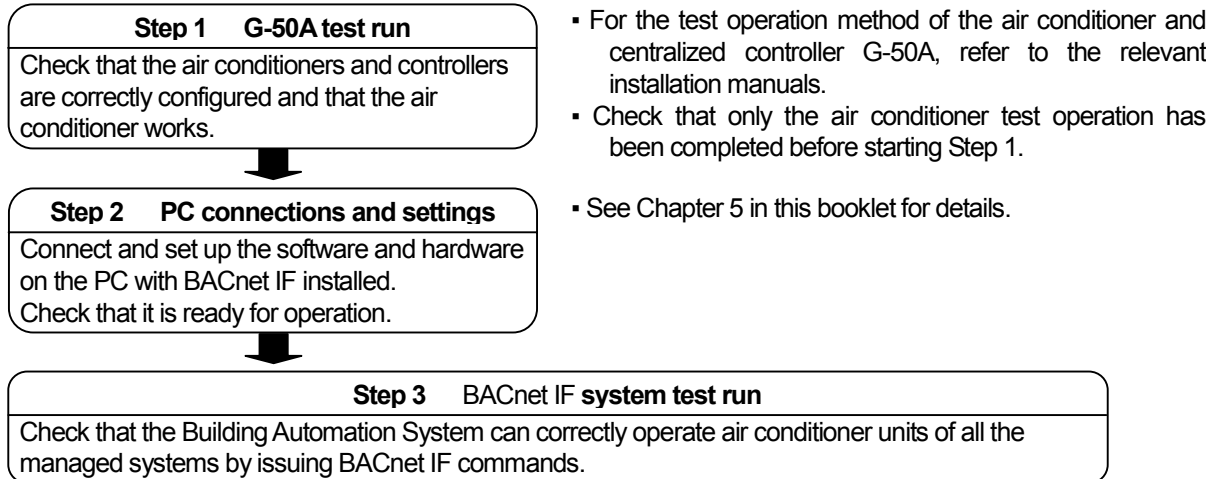

9.2 Tools for Site Adjustment

You will need the following equipment and reference material in order to easily carry out site adjustment.

Item	Contents	Note
Measurement instruments	Tester	To check the wiring and the voltage
Reference material	All necessary drawing of the air conditioning control system	
	BACnet IF Operation Manual Instruction Manual and Installation Manual for each air conditioner unit and controller	This manual
Other material	Floppy disk	Used when copying data
	CD-R	Used to store generated data and copy it to the site PC
	BACnet IF CD	BACnet IF setup disk
	LAN cable	
	usual maintenance tool	

9.3 Step 1: Test operation from centralized controller G-50A

Perform only the test operation of the air-conditioning system of the central controller G-50A.

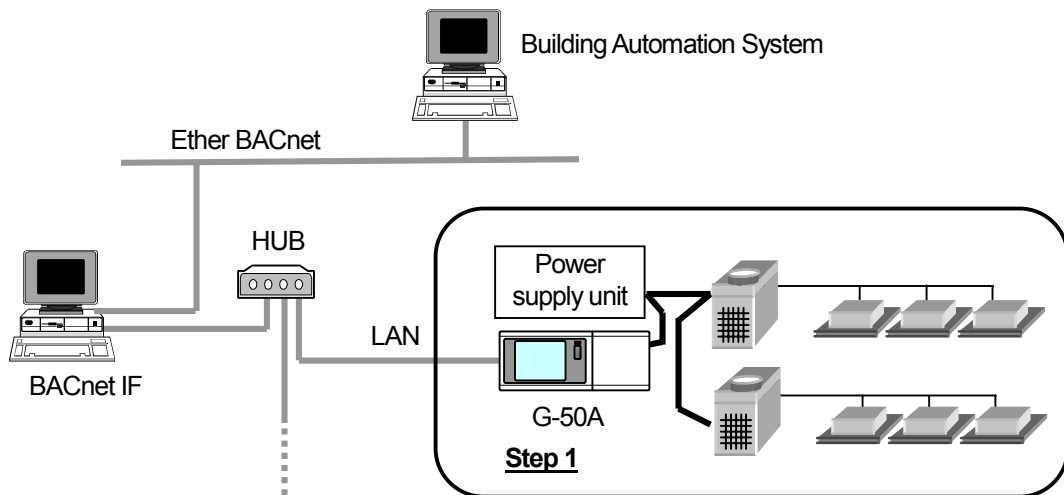

- (1) Preliminary check
Check that the test operation of the air conditioner has been completed.
Check that the central controller G-50A is set to Group and Interlock.
(The initial setting is executable using the initial setting tool or the G-50A.)
- (2) Test operation from central controller G-50A
After supplying power to the central controller G-50A and all air conditioners, perform the test operation from the central controller G-50A, and check the operation state of each unit.
* For the test operation method, refer to the installation manual for the air conditioner or the central controller G-50A.

9.4 Step 2: Initial setting of BACnet IF

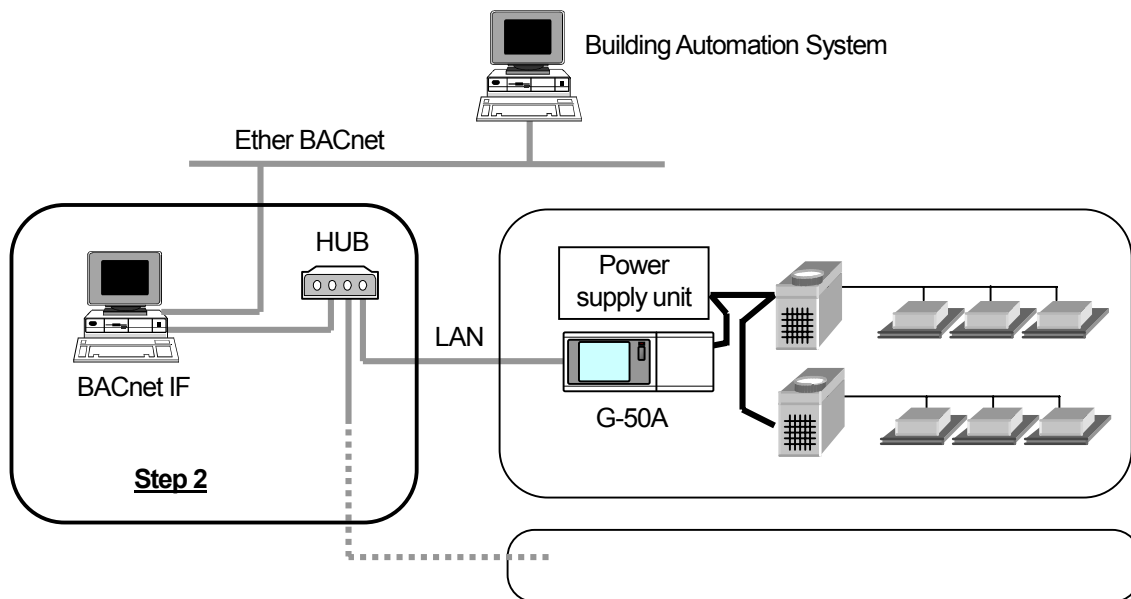

(1) Set-up of BACnet IF

Make preparations to allow the PC to be operative in order to install BACnet IF. After performing the set-up preparations, set up BACnet IF.

Note:

- For the set-up procedure, refer to Chapter 5.
- For safety, check the installation state/connection before turning the power ON.

(2) Check the G-50A IP address and PC (which uses BACnet IF)

Check the G-50A IP address. Check the IP address used for BACnet IF at the same time. Normally, set the sub-net to "255.255.255.0".

A setup an IP address etc. should use and set up the function of OS of a network setup.

For a LAN dedicated to the G-50A system, it is recommended to set the IP address within the following range. IP address decides that it does not overlap.

Models	IP address range
G-50A main unit	[192.168.1.1] to [192.168.1.40]
PC (using BACnet IF)	for BMS network: [192.168.2.1] for G-50A system: [192.168.1.250]

* To connect to the existing LAN, set the IP address and sub-net mask set by the LAN manager.

(3) LAN connection confirmation

Check that the LAN cable is connected to the G-50A, PC (using BACnet IF), and hub, and that power is supplied to the hub.

(4) Initial setting of BACnet IF

Start BACnet IF to execute the initial setting.

Note:

- For the initial setting method of BACnet IF, refer to Chapters 6 to 8.

9.5 Setting Check

Follow a setting item checklist according to each function you want to use.

Item		Point	Target
G-50A setup	IP Address	Is it in agreement with the G-50A number registered into BMS?	G-50A Setting Tool
		Is it in agreement with the IP address set as G-50A?	
Group setup	Group setup	Is it in agreement with the information registered into G-50A?	G-50A Setting Tool
BACnet setup	Parameter	Is it a setup, which suited the specification of a system?	Setting Tool
	NotificationSetting	Is it a setup, which suited the specification of a system?	Setting Tool
System setup	Unit of Temperature	Is it a setup, which suited the specification of a system?	Setting Tool
	Drive Mode	Is it a setup, which suited the specification of a system?	Setting Tool
	Air Speed Type	Is it a setup, which suited the specification of a system?	Setting Tool
	G-50 Time set	Is it a setup, which suited the specification of a system?	Setting Tool
	Reboot	Is it a setup, which suited the specification of a system?	Setting Tool
Time set	Date and Time Settings	Is it set up correctly?	Windows
Automatic login settings	Windows setting	Is it a setup, which suited the specification of a system? When the BACnet IF is set to Auto reboot, be sure to set the Automatic login.	Windows
	Automatic reboot	Is it a setup, which suited the specification of a system? When the BACnet IF is set to Auto reboot, be sure to set the Automatic start-up.	Windows
Power options	Power setting	Is it a setup, which suited the specification of a system?	Windows

9.6 Step 3: Test operation from BMS (Building Management System)

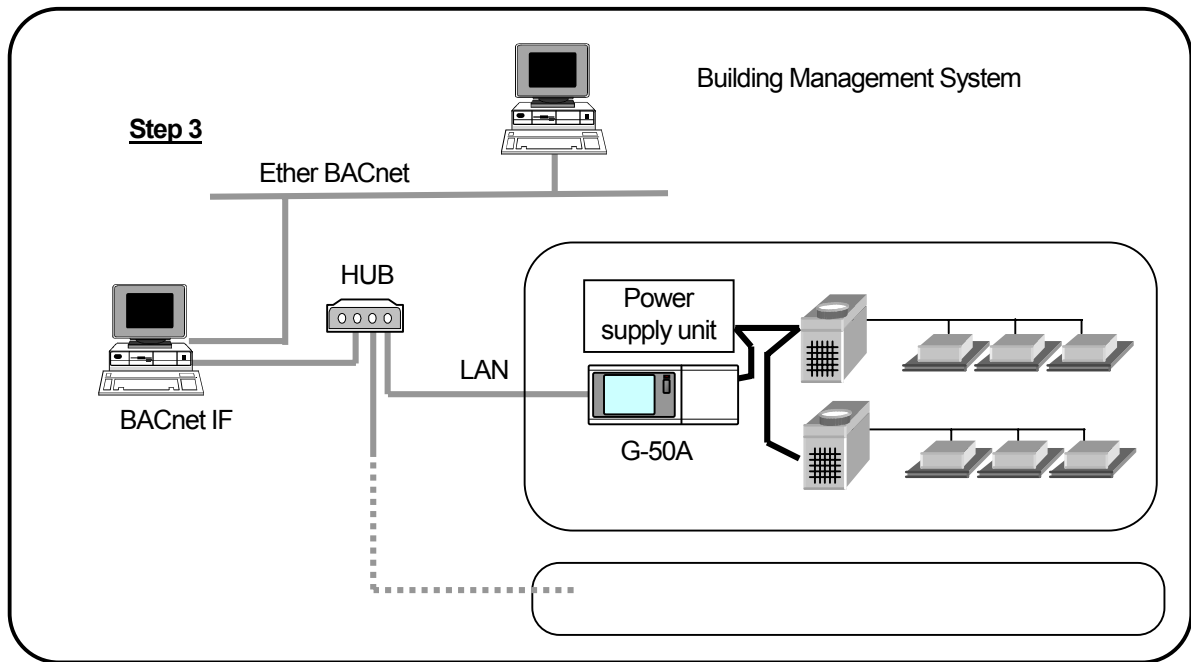

Perform the test operation from BMS to check the operation state and monitor display of the air conditioner.

A surveillance point is shown in the following page. (Refer to Chapter 4 for details.)

BACnet Interface PAC-YG31CDA Site Adjustment sheet

G-50A Number [] IPaddress[. . .] Group Number[]

Object	Object type	Instance number *5)	Management item	Test procedure	Result
On/Off (setup)	BO	xxxx01	Inactive: On Active: Off	- Change operation/stop of a certain group from BMS *6. Then, it checks by G-50A whether the state of an air-conditioning system is equal to the state where it was operated by BMS.	
On/Off (state)	BI	xxxx02	Inactive: On Active: Off	- Change operation/stop of a group by G-50A. Then, the state of BACnet IF is read from BMS and it checks in the same state as G-50A.	
Alarm signal	BI	xxxx03	Inactive: Normal Active: Abnormalities	- Make a malfunction of unit. Then, a state is read from BMS and it checks in Abnormalities (ACTIVE). - Restore a malfunction of unit. Then, the state of BACnet IF is read from BMS and it checks in Normal (INACTIVE). Then, it checks whether Event Notification is transmitted to BMS from BACnet IF.	
Error Code	MI	xxxx04	01: Normal 02: Other abnormality 03: Refrigerant system abnormality 04: Water system abnormality 05: Air system abnormality 06: Electric system abnormality 07: Sensor abnormality 08: Communication abnormality 09: System abnormality	- Remove the transmission line of M-NET connected to G-50A. Then, the state of BACnet IF is read from BMS and it checks in the Communication abnormality (08). - Connect the transmission line of M-NET to G-50A. Then, that of a BACnet IF state is read from BMS, and it checks in Normal (01).	
Operation mode (setup)	MO	xxxx05	01: Cool 02: Heat 03: Fan 04: Auto 05: Dry *1)	- Change the operation mode of a group from BMS. Then, it checks by G-50A whether the state of an air-conditioning system is equal to the state where it was operated by BMS.	
Operation mode (state)	MI	xxxx06	01: Cool 02: Heat 03: Fan 05: Dry *1)	- Change the operation mode of a group by G-50A. Then, the state of BACnet IF is read from BMS and it checks in the same state as G-50A.	
Fan Speed (setup)	MO	xxxx07	01: Lo 02: Hi 03: Mid2 *2) 04: Mid1 *2)	- Change the Fan Speed of a group from BMS. Then, it checks by G-50A whether the state of an air-conditioning system is equal to the state where it was operated by BMS.	
Fan Speed (state)	MI	xxxx08	01: Lo 02: Hi 03: Mid2 *2) 04: Mid1 *2)	- Change the Fan Speed of a group by G-50A. Then, the state of BACnet IF is read from BMS and it checks in the same state as G-50A.	
Room Temp.	AI	xxxx09	°F / °C	- Read the Room Temp of a group from BMS and check whether it is the same as the state of G-50A.	
Set Temp.	AV	xxxx10	°F / °C	- Read the indoor setting temperature of a group from BMS, and check whether it is the same as the state of G-50A.	
Filter Signal	BI	xxxx11	Inactive: OFF Active: ON	- Read the Filter Signal of a group from BMS, and check whether it is the same as the state of G-50A.	
Filter Signal Reset	BV	xxxx12	Inactive: RESET ACTIVE: Void	- Set a Filter Signal to RESET (INACTIVE) from BMS to the group, which has detected the Filter Signal. Then, the state of an air-conditioning system is equal to the state where it was operated by BMS, or it checks by G-50A.	
Prohibition of local operation (On/Off)	BV	xxxx13	Inactive: Permit Active: Prohibit	- Change remote control hand operation (On/Off) of a group from BMS. Then, it checks by G-50A whether the state of an air-conditioning system is equal to the state where it was operated by BMS. - Change remote control hand operation (On/Off) of a specific group by G-50A. Then, the state of BACnet IF is read from BMS and it checks in the same state as G-50A.	

Object	Object type	Instance number *5)	Management item	Test procedure	Result
Prohibition of local operation (Mode)	BV	xxxx14	Inactive: Permit Active: Prohibit	- Change remote control hand operation (Mode) of a group from BMS. Then, it checks by G-50A whether the state of an air-conditioning system is equal to the state where it was operated by BMS. - Change remote control hand operation (Mode) of a specific group by G-50A. Then, the state of BACnet IF is read from BMS and it checks in the same state as G-50A.	
Prohibition of local operation (filter reset)	BV	xxxx15	Inactive: Permit Active: Prohibit	- Change remote control hand operation (filter reset) of a specific group by G-50A. Then, the state of BACnet IF is read from BMS and it checks in the same state as G-50A.	
Prohibition of local operation (Set Temp.)	BV	xxxx16	Inactive: Permit Active: Prohibit	- Change remote control hand operation (Set Temp) of a group from BMS. Then, it checks by G-50A whether the state of an air-conditioning system is equal to the state where it was operated by BMS. - Change remote control hand operation (Set Temp) of a specific group by G-50A. Then, the state of BACnet IF is read from BMS and it checks in the same state as G-50A.	
Communication State	BI	xxxx20	Inactive: Normal Active: Abnormal	- Remove the transmission line of LAN connected to G-50A. Then, a state is read from BMS and it checks in Abnormalities (ACTIVE). - Connect the transmission line of LAN to G-50A. Then, the state of BACnet IF is read from BMS and it checks in Normal (INACTIVE). - Remove the transmission line of LAN connected to G-50A. Then, it checks whether Event Notification is transmitted to BMS from PAC-YG31CDA.	
System Forced Off	BV	xx9921	Inactive: Released Active: Effective	- Change the system forced Off of a group from BMS. Then, it checks by G-50A whether the state of an air-conditioning machine is equal to the state where it was operated by BMS.	
Air direction (setup)	MO	xxxx22	01: Horizontal 02: Down 60% 03: Down 80% 04: Down 100% 05: Swing	- Change the wind direction of a group from BMS. Then, it checks by G-50A whether the state of an air-conditioning machine is equal to the state where it was operated by BMS.	
Air direction (state)	MI	xxxx23	01: Horizontal 02: Down 60% 03: Down 80% 04: Down 100% 05: Swing	- Change the wind direction of a group by G-50A. Then, the state of BACnet IF is read from BMS and it checks in the same state as G-50A.	

*1) It can use, if dry operation use is set up.

*2) It can use, if use of Mid1/Mid2 is set up.

*3) The group of LC serves as an item with an invalid attribute.

*4) As for the operation mode of the group of LC, an attribute serves as ventilation fixation.

*5) XXXX of an instance number consists of G50 number + group numbers.

*6) BMS: Building Management System

Appendix 1: Auto Log – In Confirmation Method

This chapter describes the procedure for confirming that the Auto login setting is validated.



- 1) Select [User account] on [Control Panel].
- 2) Select [Change user's log-on/log-off method].
- 3) Check that both check boxes for "Use welcome" screen and "Use user's simplified changeover" are checked. If these boxes are not checked, click the check boxes to check them. Click the [Application of option] button to return to the user account screen.
- 4) Exit the user account screen.

Appendix 2: Initial Value

The initial value of the property of each object is shown.

Object	Object Type	Instance Number	Present Value	Note
On/Off (setup)	BO	xxxx01	OFF (0)	
On/Off (state)	BI	xxxx02	OFF (0)	
Alarm Signal	BI	xxxx03	Normal (0)	
Error Code	MI	xxxx04	Normal (1)	
Operation Mode (setup)	MO	xxxx05	Fan (3)	
Operation Mode (state)	MI	xxxx06	Fan (3)	
Fan Speed (setup)	MO	xxxx07	Low (1)	
Fan Speed (state)	MI	xxxx08	Low (1)	
Room Temp.	AI	xxxx09	69° F (21°C)	
Set Temp.	AV	xxxx10	69° F (21°C)	
Filter Signal	BI	xxxx11	Off (0)	
Filter Signal Reset	BV	xxxx12	Reset (0)	
Prohibition of local operation (On/Off)	BV	xxxx13	Permit (0)	
Prohibition of local operation (Mode)	BV	xxxx14	Permit (0)	
Prohibition of local operation (Filter Reset)	BV	xxxx15	Permit (0)	
Prohibition of local operation (Set Temp)	BV	xxxx16	Permit (0)	
Communication State	BI	xxxx20	Normal (0)	
System Forced Off	BV	xx9921	Release (0)	
Air Direction (setup)	MO	xxxx22	Horizontal (1)	
Air Direction (state)	MI	xxxx23	Horizontal (1)	
Notification Class	Notification Class	000003	-	
Device	Device	000003	-	

Appendix 3: Correcting the system setting data when PC fails or is replaced.

When PC, which set up BACnet, breaks down or it replaces, how to restore system setting data is shown.

1. How to back up system setting data

System setting data is copied to CD-R from the personal computer of a site.

[What you need]

CD-R (The recording medium which can be used with the personal computer of a site)

[Procedure]

- 1) Start the BACnet IF and Setting Tool.
- 2) Select [Get Settings] in the [BACnetIF] menu to get the setting data. from BACnet IF.
- 3) Select [Save Settings As] in the [File] menu to save the setting data.
Create the work folder to save the backup file.
When you use CD-R, please copy a file using exclusive software.
When you use FD for a recording medium, please use Explorer of Windows and copy a file.

Note:

Please do this work, whenever it changes a setup.

2. How to restore system setting data

A backup file is transmitted to PC, which set up BACnet IF.

[What you need]

CD-R (CD-R with which system setting data is saved)

[Procedure]

- 1) Start the BACnet IF and Setting Tool.
- 2) Select [Open Setting] in the [File] menu to load the backup file.
- 3) Select the [Put Settings] in a [BACnetIF] menu to send the setting file to BACnet IF.
- 4) Restart BACnet IF.
BACnet IF reads setting information at once at the time of starting.



HEAD OFFICE: MITSUBISHI DENKI BLDG., 2-2-3, MARUNOUCHI, CHIYODA-KU, TOKYO 100-8310, JAPAN

WT04221X03