

INTEGRITY SERIES CROSS-TRAINER (CSX)

OPERATION MANUAL

08.17.10 M051-00K61-A137



LifeFitness
WHAT WE LIVE FOR

CORPORATE HEADQUARTERS

5100 River Road
Schiller Park, Illinois 60176 • U.S.A.
847.288.3300 • FAX: 847.288.3703
800.735.3867 (Toll-free within U.S.A., Canada)
Global Website: www.lifefitness.com

INTERNATIONAL OFFICES

AMERICAS

North America Life Fitness Inc.

5100 N River Road
Schiller Park, IL 60176 U.S.A
Telephone: (847) 288 3300
Fax: (847) 288 3703
Service Email: commercialservicereply@lifefitness.com
Sales/Marketing Email: commercialsales@lifefitness.com
Operating Hours: 7:00 am - 6:00 pm (CST)

Brazil Life Fitness Brasil

Av. Cidade Jardim, 900
Jd. Paulistano
São Paulo, SP 01454-000
BRAZIL
SAC: 0800 773 8282
Telephone: +55 (11) 3095 5200
Fax: +55 (11) 3095 5201
Service Email: suporte@lifefitness.com.br
Sales/Marketing Email: lifefitness@lifefitness.com.br
Service Operating Hours:
9:00 - 17:00 (BRT) (Monday-Friday)
Store Operating Hours:
9:00 - 20:00 (BRT) (Monday-Friday)
10:00 - 16:00 (BRT) (Saturday)

Latin America & Caribbean* Life Fitness Inc.

5100 N River Road
Schiller Park, IL 60176 U.S.A
Telephone: (847) 288 3300
Fax: (847) 288 3703
Service Email: customersupport@lifefitness.com
Sales/Marketing Email: commercialsales@lifefitness.com
Operating Hours: 7:00am-6:00pm (CST)

EUROPE, MIDDLE EAST, & AFRICA (EMEA)

Netherlands & Luxemburg Life Fitness Atlantic BV

Bijdorplein 25-31
2992 LB Barendrecht
THE NETHERLANDS
Telephone: (+31) 180 646 666
Fax: (+31) 180 646 699
Service Email: service.benelux@lifefitness.com
Sales/Marketing Email:
marketing.benelux@lifefitness.com
Operating Hours: 9.00h-17.00h (CET)

United Kingdom & Ireland Life Fitness UK LTD

Queen Adelaide
Ely, Cambs, CB7 4UB
Telephone: General Office (+44) 1353.666017
Customer Support (+44) 1353.665507
Fax: (+44) 1353.666018
Service Email: uk.support@lifefitness.com
Sales/Marketing Email: life@lifefitness.com
Operating Hours:
General Office: 9.00am - 5.00pm (GMT)
Customer Support: 8.30am - 5.00pm (GMT)

Germany & Switzerland

Life Fitness Europe GMBH

Siemensstraße 3
85716 Unterschleißheim
GERMANY
Telephone: (+49) 89.31 77 51.0 (Germany)
(+41) 0848 000 901 (Switzerland)
Fax: (+49) 89.31 77 51.99 (Germany)
(+41) 043 818 07 20 (Switzerland)
Service Email: kundendienst@lifefitness.com
Sales/Marketing Email: kundenberatung@lifefitness.com
Operating Hours: 08.30 - 16.30h (CET)

Austria

Life Fitness Austria

Vertriebs G.m.b.H.
Dückerstraße 7-9/3/36
1220 Vienna
AUSTRIA
Telephone: (+43) 1.61.57.198
Fax: (+43) 1.61.57.198.20
Service Email: kundendienst@lifefitness.com
Marketing/Sales Email: kundenberatung@lifefitness.com
Operating Hours: 9.00h-17.00h (MEZ)

Spain

Life Fitness IBERIA

C/Frederic Mompou 5,1ª^a
08960 Sant Just Desvern Barcelona
SPAIN
Telephone: (+34) 93.672.4660
Fax: (+34) 93.672.4670
Service Email: info.iberia@lifefitness.com
Sales/Marketing Email: info.iberia@lifefitness.com
Operating Hours:
9.00h-18.00h (Monday-Thursday)
8.30h-15.00h (Friday)

Belgium

Life Fitness Benelux NV

Parc Industriel de Petit-Rechain
4800 Verviers
BELGIUM
Telephone: (+32) 87 300 942
Fax: (+32) 87 300 943
Service Email: internationalcustomersupport@lifefitness.com
Sales/Marketing Email: marketing.benelux@lifefitness.com
Operating Hours: 9.00h - 17.00h (CET)

Italy

Life Fitness Europe GmbH

Siemensstraße 3
85716 Unterschleißheim
GERMANY
Telephone: (+39) 02-55378611
Service: 800438836 (In Italy)
Fax: (+39) 02-55378699
Service Email: assistenza@lifefitness.com
Sales/Marketing Email: info@lifefitnessitalia.com
Operating Hours: 08:30 - 16:30h (CET)

All Other EMEA countries & distributor business C-EMEA*

Bijdorplein 25-31
2992 LB Barendrecht
THE NETHERLANDS
Telephone: (+31) 180 646 644
Fax: (+31) 180 646 699
Service Email: service.db.cemea@lifefitness.com
Sales/Marketing Email:
marketing.db.cemea@lifefitness.com
Operating Hours: 9.00h-17.00h (CET)

ASIA PACIFIC (AP)

Japan

Life Fitness Japan

Nippon Brunswick Bldg., #8F
5-27-7 Sendagaya
Shibuya-Ku, Tokyo
Japan 151-0051
Telephone: (+81) 3.3359.4309
Fax: (+81) 3.3359.4307
Service Email: service@lifefitnessjapan.com
Sales/Marketing Email: sales@lifefitnessjapan.com
Operating Hours: 9.00h-17.00h (JAPAN)

China and Hong Kong

Life Fitness Asia Pacific LTD

Room 2610, Miramar Tower
132 Nathan Road
Tsimshatsui, Kowloon
HONG KONG
Telephone: (+852) 2891.6677
Fax: (+852) 2575.6001
Service Email: HongKongEnquiry@lifefitness.com
Sales/Marketing Email: ChinaEnquiry@lifefitness.com
Operating Hours: 9.00h-18.00h

All Other Asia Pacific countries & distributor business Asia Pacific*

Room 2610, Miramar Tower
132 Nathan Road
Tsimshatsui, Kowloon
HONG KONG
Telephone: (+852) 2891.6677
Fax: (+852) 2575.6001
Service Email: HongKongEnquiry@lifefitness.com
Sales/Marketing Email: ChinaEnquiry@lifefitness.com
Operating Hours: 9.00h-18.00h

* Also check www.lifefitness.com for local representation or distributor/dealer.

TABLE OF CONTENTS

Section	Description	
1.	Getting Started	5
1.1	Important Safety Instructions	5
1.2	Setup	7
2.	Console Overlay	9
2.1	Console Overlay Overview	9
2.2	Console Overlay Descriptions	10
2.3	Reading Rack and Accessory Trays	12
3.	Heart Rate Zone Training®	13
3.1	Why Heart Rate Zone Training® Exercise	13
3.2	Heart Rate Monitoring	14
4.	The Workouts	16
4.1	Workout Overviews	16
4.2	Using the Workouts	17
4.3	Workout Descriptions	21
4.4	Using My Workouts Personal Programs	29
5.	System Menu	31
5.1	Entering and Using the System Menu	31
5.2	Manager's Configuration (Optional Settings)	32
6.	Service and Technical Data	34
6.1	Preventive Maintenance Tips	34
6.2	Preventive Maintenance Schedule	35
6.3	Troubleshooting the Optional Polar® Telemetry Heart Rate Chest Strap	36
6.4	Troubleshooting the iPod®	38
6.5	Troubleshooting the Lifepulse™ System Sensors	40
6.6	How to Obtain Product Service / Serial Number Location	40
7.	Specifications	41
7.1	CSX Cross-Trainer Specifications	41
7.2	CSX Warranty Information	42

Before using this product, it is essential that this ENTIRE operation manual and ALL installation instructions be read. It describes equipment setup and instructs members on how to use it correctly and safely.

Avant toute utilisation de ce produit, il est indispensable de lire ce manuel d'utilisation dans son INTÉGRALITÉ, ainsi que TOUTES les instructions d'installations.

Ce manuel explique comment installer l'équipement et comment l'utiliser correctement et sans danger.

FCC Warning - Possible Radio / Television Interference

NOTE: *This equipment has been tested and found to comply with the limits for a Class B digital device, pursuant to part 15 of the FCC rules. These limits are designed to provide reasonable protection against harmful interference in a residential installation. This equipment generates, uses and can radiate radio frequency energy, and if not installed and used in accordance with the user manual, may cause harmful interference to radio communications. However, there is no guarantee that the interference will not occur in a particular installation. If this equipment does cause harmful interference to radio or television reception, which can be determined by turning the equipment off and on, the user is encouraged to try to correct the interference by one or more of the following measures:*

- *Re-orient or relocate the receiving antenna.*
- *Increase the separation between the equipment and the receiver.*
- *Connect the equipment into an outlet on a circuit different from that to which the receiver is connected.*
- *Consult the dealer or an experienced radio/TV technician for help.*



CAUTION: Any changes or modifications to this equipment could void the product warranty.



MISE EN GARDE: Tout changement et toute modification de ce matériel peut annuler la garantie du produit.

Any service, other than cleaning or user maintenance, must be performed by an authorized service representative. There are no user serviceable parts

This Operation Manual describes the functions of the following product:

Integrity Series Cross-Trainer (CSX)

See "Specifications" in this manual for product specific features.

Statement of Purpose: The Life Fitness Cross-Trainer is an exercise machine that combines low-impact elliptical pedaling with push/pull arm motion to provide an efficient, effective total body workout.



CAUTION: Life Fitness STRONGLY recommends seeing a physician for a complete medical exam before undertaking an exercise program, particularly if the user has a family history of high blood pressure or heart disease, or is over the age of 45, or smokes, has high cholesterol, is obese, or has not exercised regularly in the past year.

If, at any time while exercising, the user experiences faintness, dizziness, pain, or shortness of breath, he or she must stop immediately.



MISE EN GARDE: Life Fitness conseille VIVEMENT de consulter un médecin pour subir un examen médical complet avant de commencer tout programme d'exercice, et tout particulièrement si l'utilisateur a des antécédents familiaux d'hypertension ou de troubles cardiaques, ou s'il a plus de 45 ans, s'il fume, s'il a du cholestérol, s'il est obèse ou n'a pas fait d'exercice régulièrement depuis un an.

Si, pendant l'utilisation de l'appareil, l'utilisateur ressent un malaise, des vertiges, des douleurs ou des difficultés à respirer, il doit cesser immédiatement.

1 GETTING STARTED

1.1 IMPORTANT SAFETY INSTRUCTIONS



SAFETY WARNING: The safety of the product can be maintained only if it is examined regularly for damage and wear. See Preventive Maintenance section for details.

- **DANGER:** To reduce the risk of electrical shock, always unplug this Life Fitness product before cleaning or attempting any maintenance activity.
- **WARNING:** To reduce the risk of burns, fire, electric shock or injury, it is imperative to connect each product to a properly grounded electrical outlet.
- Never operate a Life Fitness product if it has a damaged power cord or electrical plug, or if it has been dropped, damaged, or even partially immersed in water. If this occurs, contact Life Fitness Customer Support Services.
- Position this product so the power cord plug is accessible to the user.
- Keep the power cord away from heated surfaces. Do not pull the equipment by the power cord or use the cord as a handle. Do not run the power cord on the floor under or along the side of the Life Fitness Cross-Trainer.
- If the electrical supply cord is damaged it must be replaced by the manufacturer, an authorized service agent, or a similarly qualified person to avoid a hazard.
- If this Life Fitness product does not function properly after it has been dropped, damaged, or even partially immersed in water, contact Life Fitness Customer Support Services for assistance.
- Always follow the console instructions for proper operation.
- Close supervision is necessary when used by children, invalids or disabled persons.
- Do not use this product outdoors, near swimming pools or in areas of high humidity.
- Never operate a Life Fitness product with the air openings blocked. Keep air openings free of lint, hair or any other obstructing material.
- Never insert objects into any opening in this product. If an object should drop inside, carefully retrieve it. If the item cannot be reached, contact Life Fitness Customer Support Services.
- Never place liquids of any type directly on the unit, except in the water bottle holder. Containers with lids are recommended.
- Wear shoes with rubber or high-traction soles. Do not use shoes with heels, leather soles, cleats or spikes. Make sure no stones are embedded in the soles.
- Keep all loose clothing, shoelaces and towels away from moving parts.
- Do not use this product in bare feet.
- Do not tip the unit on its side during operation.
- Keep the area around the Life Fitness product clear of any obstructions, including walls and furniture. Ensure that there is at least one foot of clearance in front of the Life Fitness Cross-Trainer.
- Use caution when mounting or dismounting the Life Fitness Cross-Trainer. Use the stationary handlebars whenever additional stability is required. While exercising, hold onto the moving arms.
- Never use the Life Fitness Cross-Trainer while facing backward.
- Do not stand or sit on pedal lever covers or motor housing.

**SAVE THESE INSTRUCTIONS
FOR FUTURE REFERENCE.**

1 POINT DE DÉPART

1.1 CONSIGNES DE SÉCURITÉ IMPORTANTES



CONSIGNE DE SÉCURITÉ : pour un emploi sûr, le produit doit être inspecté régulièrement afin de s'assurer qu'il n'est pas usé ni endommagé. Consultez la section de Maintenance préventive pour obtenir de plus amples informations.

- **DANGER:** Pour réduire les risques de décharge électrique, toujours débrancher cet appareil Life Fitness avant le nettoyage ou toute mesure d'entretien.
- **AVERTISSEMENT:** Pour réduire les risques de brûlures, d'incendies, de décharges électriques ou de blessures, chaque appareil doit absolument être branché sur une prise électrique correctement mise à la terre.
- Ne jamais faire fonctionner un produit Life Fitness dont la fiche ou le cordon d'alimentation est endommagé, ni aucun appareil qui serait tombé ou aurait été endommagé ou même partiellement plongé dans l'eau. Appeler le service clientèle de Life Fitness.
- Placer ce produit de manière à ce que l'utilisateur puisse accéder à la fiche du cordon d'alimentation.
- Tenir le cordon d'alimentation à l'écart de toute surface chauffée. Ne pas tirer l'appareil par le cordon d'alimentation; ne pas utiliser le cordon comme poignée. Ne pas faire passer le cordon sur le sol, sous le tapis roulant, ni le long de l'appareil. Se reporter à la section 1.2 pour la disposition adéquate du cordon d'alimentation.
- Si le cordon d'alimentation électrique est endommagé, il doit être remplacé par le fabricant, par un réparateur agréé ou par une personne qualifiée afin d'éviter tout danger.
- Si l'appareil Life Fitness ne fonctionne pas correctement après avoir subi une chute, des dommages ou une immersion même partielle dans l'eau, contactez le service d'assistance clientèle de Life Fitness.
- Pour un fonctionnement correct, suivez toujours les instructions de la console.
- Une surveillance étroite est nécessaire en cas d'utilisation par des enfants, des personnes invalides ou handicapées.
- N'utilisez pas ce produit à l'extérieur, près d'une piscine ou dans endroits très humides.
- Ne faites jamais fonctionner de produit Life Fitness dont les bouches d'aération seraient bloquées. Maintenez-les exemptes de peluches, de cheveux ou de toute obstruction.
- N'insérez jamais d'objet dans les ouvertures de cet appareil. Si un objet tombe dedans, coupez l'alimentation électrique, débranchez le cordon de la prise et récupérez-le avec précaution. Si vous ne pouvez pas l'atteindre, consultez le service après-vente de Life Fitness.
- Ne placez jamais de liquides d'aucune sorte directement sur l'appareil, sauf si vous disposez d'un support ou d'un plateau pour accessoires. Il est recommandé d'utiliser des conteneurs munis d'un couvercle.
- Portez des chaussures avec semelles en caoutchouc ou antidérapantes. N'utilisez pas de chaussures à talons, de semelles en cuir ou à crampons. Assurez-vous qu'aucun caillou ne s'est incrusté dans les semelles.
- Maintenez les vêtements lâches, les lacets et les serviettes à l'écart des pièces en mouvement.
- N'utilisez pas cet appareil sans chaussures.
- Ne faites pas basculer l'appareil sur le côté tandis qu'il fonctionne.
- Maintenez la zone autour du produit Life Fitness exempte d'obstructions, y compris de murs et de meubles. Veillez à laisser au moins 30 cm d'espace autour du Life Fitness Cross-Trainer.
- Procédez avec précaution lors du montage ou du démontage de la machine. Utilisez la barre fixe pour renforcer votre stabilité. Pendant les exercices, saisissez les bras mobiles.
- N'utilisez jamais cet appareil en vous tournant vers l'arrière.
- Ne pas rester debout ou s'asseoir sur la pédale de levier ou de couvre carter du moteur.

**CONSERVER CES INSTRUCTIONS
POUR TOUT USAGE ULTÉRIEUR.**

1.2 SETUP

Read the Operation Manual before setting up the Life Fitness Cross-Trainer.

WHERE TO PLACE THE LIFE FITNESS® CROSS-TRAINER

Follow all safety instructions in Section 1.1 and move the Life Fitness Cross-Trainer to the location in which it will be used. See Section 7 for the dimensions of the footprint. Allow 1 foot of clearance in front of the Life Fitness Cross-Trainer to allow for movement of the pedal levers. It should be easy to mount the Life Fitness Cross-Trainer from the side.

HOW TO STABILIZE THE LIFE FITNESS CROSS-TRAINER

After placing the Life Fitness Cross-Trainer in position, check the unit's stability by attempting to rock it. Any slight rocking indicates that the unit must be leveled. Check the stabilizing feet to determine which foot does not rest fully on the floor. Rotate the foot counter-clockwise to lower it. Recheck the stability and adjust again as needed until the Life Fitness Cross-Trainer is stable and no longer rocks. **Lock the adjustment into position by tightening the jam nut against the stabilizer bar with an open end 9/16 inch wrench.**

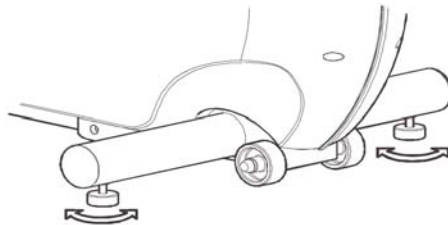

PLUG IN THE LIFE FITNESS CROSS-TRAINER

The Life Fitness Cross-Trainer comes with a standard power supply for the U.S., or a universal power supply that will accept country-specific line cords.

Insert the power adapter jack into the barrel plug on the back of the Life Fitness Cross-Trainer. Then insert the power supply into the wall outlet (A) (or the universal power supply if outside the U.S. (B)). Make sure the cord is routed so that it doesn't bind and will not be walked on.

Check that the console LEDs light up. If not, recheck the plug and wall connections and make sure the wall outlet has power.

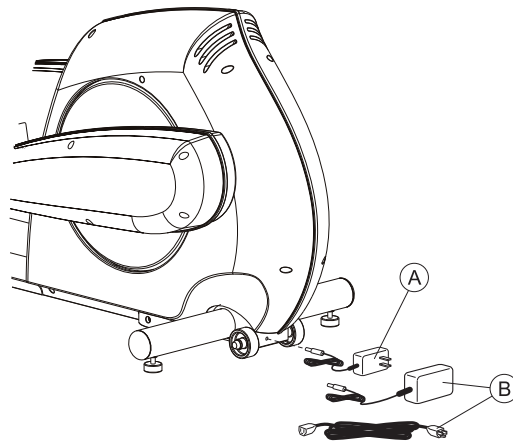

SERVICE ACCESS PORT

The two interchangeable type RJ45 networking ports (A) are located on the back of the display console. These network ports, located behind the display console rear access door, allow for console software updates.

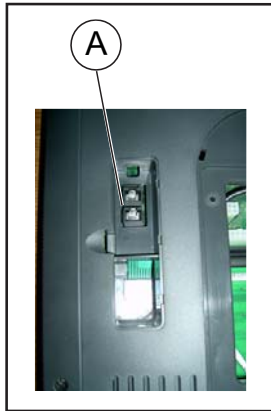

2 CONSOLE OVERLAY

2.1 CONSOLE OVERLAY OVERVIEW

The computerized display console on the Cross-Trainer allows the user to tailor a workout to personal fitness abilities and goals and to monitor progress. With this easy-to-use console, the user can track fitness improvement from one workout to the next.

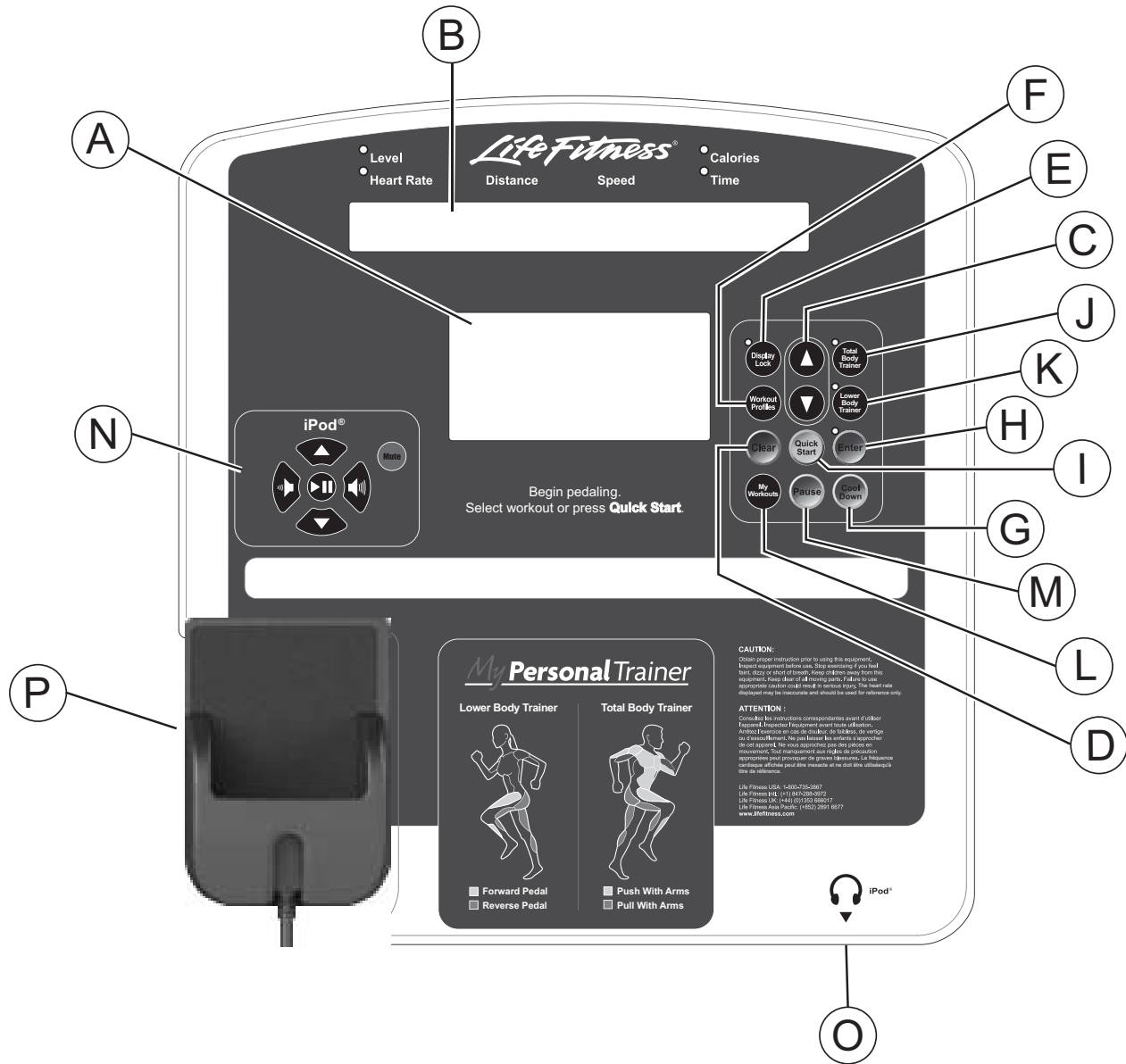

2.2 CONSOLE OVERLAY DESCRIPTIONS

- A. **WORKOUT PROFILE** window: This window displays shapes, made of columns of lights, that represent the levels of intensity in a workout-in-progress. The height of the first column on the left side of the window is proportional to the current level of intensity.

During a **FAT BURN, CARDIO, HEART RATE HILL, HEART RATE INTERVAL, or EXTREME HEART RATE** workout, which requires the use of a Polar® telemetry heart rate chest strap or the Lifepulse system sensors, the **WORKOUT PROFILE** window displays a flashing heart shape to request the user's heart rate signal. If the console does not detect a signal, the **MESSAGE CENTER** displays the prompt "NEED HEART RATE - PLACE HANDS ON SENSORS OR USE TELEMETRY STRAP". If the console does not receive the signal within three minutes, the workout automatically is converted to a **MANUAL** program.

- B. **MESSAGE CENTER**: This window displays step-by-step instructions for setting up a workout. During a workout, it displays statistics about the progress of the workout:
- **Level**: programmed intensity level. Toggles with Heart Rate.
 - **Heart Rate**: the detected heart rate if the user is wearing the Polar telemetry heart rate chest strap or grasping the Lifepulse system sensors.
 - **Distance**: the total distance traveled in miles (or kilometers if enabled).
 - **Speed**: the pedaling speed or rate in miles per hour (or kilometers per hour if enabled).
 - **Calories**: the number of calories burned since beginning the workout. Toggles with Time.
 - **Time**: time elapsed since the start of the workout. Toggles with Calories.

If configured to do so, the **MESSAGE CENTER** displays any or all of these three values each time the intensity level changes during the workout:

- **Calories per Hour**: the rate of calories burned per hour.
- **Watts**: effort level in Watts. The Watt is a unit of power output or the expression of the mechanical rate of work.
- **METs**: effort level in METs. The MET is an expression of the rate of work for the human body at rest, or a metabolic equivalent; one MET is approximately equal to the metabolism of a person at rest.

Note: *The Watts display and the Calories per Hour display cannot be turned on at the same time.*

See Section 5 for information about enabling the **MESSAGE CENTER** to display these additional settings.

- C. **ARROW** keys: Use the **UP** and **DOWN ARROW** keys to change workout parameters displayed on the console, such as length of workout, weight, age, target heart rate, and intensity level. Pressing these keys during a **FAT BURN, CARDIO, HEART RATE HILL, HEART RATE INTERVAL, or EXTREME HEART RATE** workout increases or decreases the target heart rate.
- D. **CLEAR** key: Press this key, when programming a workout, to clear incorrect data, such as weight or age, before pressing the **ENTER** key. Pressing **CLEAR** during a workout stops it immediately, at which point, the **MESSAGE CENTER** displays a summary of the workout, including total time elapsed, total distance traveled, and total calories burned. Pressing **CLEAR** a second time causes the **MESSAGE CENTER** to prompt the user for a new workout setup.
- E. **DISPLAY LOCK**: During a workout, the **MESSAGE CENTER** alternately displays the number of **CALORIES** burned and the amount of **TIME** elapsed. Pressing the **DISPLAY LOCK** key when the **MESSAGE CENTER** displays either statistic, forces the **MESSAGE CENTER** to display that statistic continuously throughout the workout. Pressing **DISPLAY LOCK** again allows the **MESSAGE CENTER** to resume toggling between both statistics.
- F. **WORKOUT PROFILES** keys: Press this key to select workout options:
- | | | | |
|-----------------|--------------------------|------------------------------|-----------------------------|
| • MANUAL | • EZ RESISTANCE | • CARDIO | • EXTREME HEART RATE |
| • RANDOM | • SPORTS TRAINING | • HEART RATE HILL | • TOTAL BODY |
| • HILL | • FAT BURN | • HEART RATE INTERVAL | • LOWER BODY |
- **SIX PRESET WORKOUTS: Around the World, Cascades, Foothills, Interval, Kilimanjaro, Speed Training**
 - **FIT TEST**
- G. **COOL DOWN** key: Workout programs end automatically in a Cool Down mode, which lowers the intensity level. Press the **COOL DOWN** key at any desired point during a workout to go immediately into Cool Down mode. In this phase of a workout the body begins to remove lactic acid and other accumulated by-products of exercise, which build up in muscles during a workout and contribute to muscle soreness. The console automatically adjusts each workout's Cool Down level according to the individual user's performance.

- H. ENTER key: Press this key to confirm entries of workout setup values, as displayed in the MESSAGE CENTER.
- I. QUICK START key: Press this key to begin a manual workout immediately, without having to select a workout program. Once the workout is in progress, use the ARROW keys to change the intensity level or workout duration as desired.
- J. TOTAL BODY TRAINER: Press this key to activate a workout mode in which the MESSAGE CENTER displays prompts to vary the workload and emphasize different muscle groups during the workout. It can be used with any workout, except for **FAT BURN, CARDIO, HEART RATE HILL, HEART RATE INTERVAL, EXTREME HEART RATE, and EZ RESISTANCE.**
- K. LOWER BODY TRAINER: Press this key to activate a workout mode that alternates five minutes of forward motion with two minutes of reverse motion. It can be used with any workout, except for **FAT BURN, CARDIO, HEART RATE HILL, HEART RATE INTERVAL, EXTREME HEART RATE, and EZ RESISTANCE.**
- L. MY WORKOUTS: Press this key to pre-set up to seven workouts with personal setup information, such as age or level, and then store the workouts in the console memory.
- M. PAUSE: Press this key once to pause workout data accumulation. Press again to resume workout.
- N. IPOD KEYPAD: The keys are used to provide control of an iPod.
- O. HEADPHONE JACK: Headphones must be plugged into the Cross-Trainer to access the sound for the iPod. The jack is not a user-replaceable feature. Contact Life Fitness Customer Support Services for more information.
- P. IPOD HOLDER: Users can attach an iPod via a 30-pin connector. Use the iPod keypad controls to play, or your iPod controls to select a song or video and begin playing.

IPOD KEYPAD

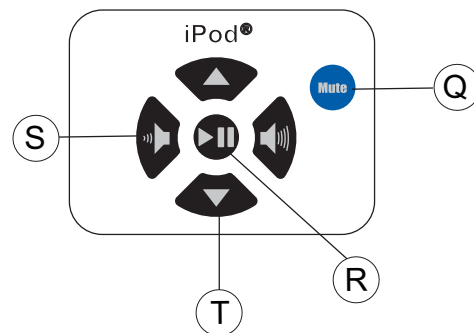

- Q. MUTE: Press this key to turn off the sound.
- R. PLAY / PAUSE: Use this key to Play or Pause the current track.
- S. LEFT AND RIGHT ARROW KEYS: Use these key to increase or decrease the volume.
- T. UP AND DOWN ARROW KEYS: Use these keys to select the next track and previous track.

2.3 READING RACK AND ACCESSORY TRAYS

The water bottle holder (A) provides easy storage for water bottles. The accessory tray (B), which is mounted near the base of the console, provides a storage tray with space for items such as personal stereos and cell phones. Additionally, an integrated reading rack (C) for allowing a book or magazine is located at the base of the upper panel of the console.

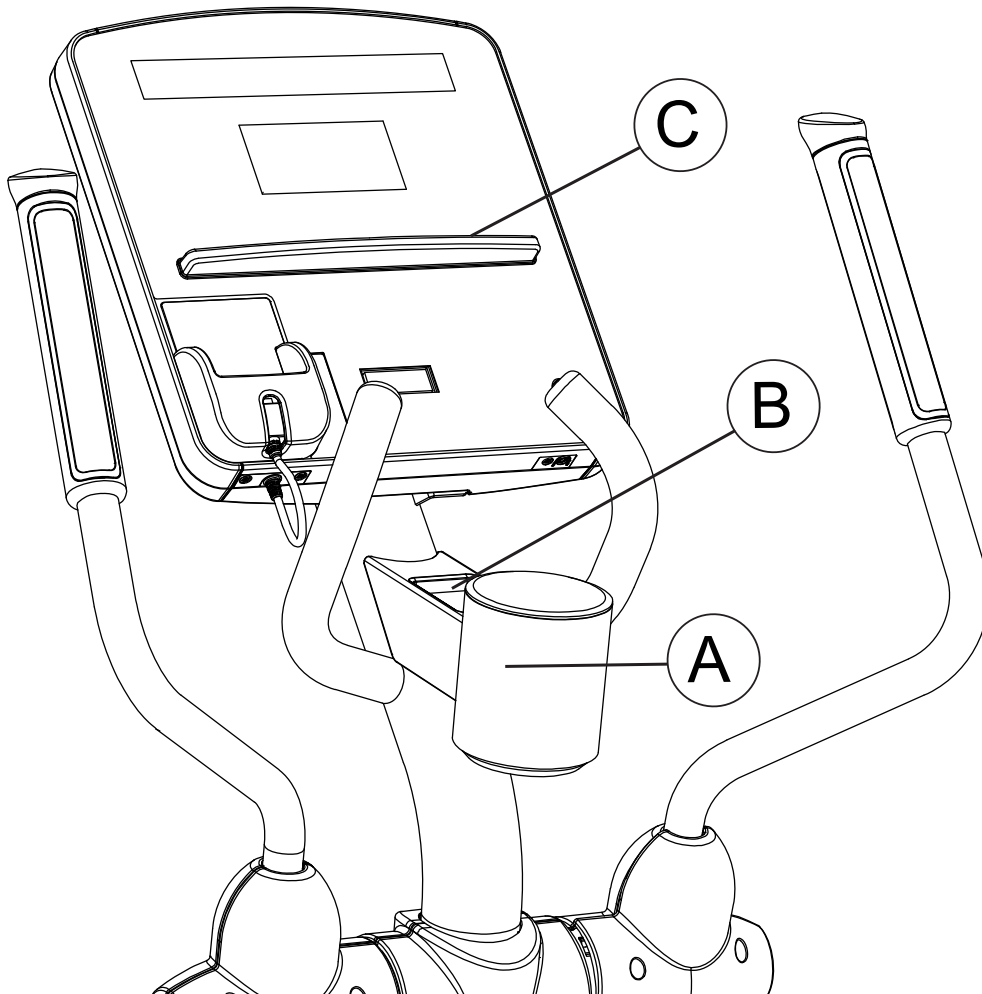

3 HEART RATE ZONE TRAINING®

3.1 WHY HEART RATE ZONE TRAINING® EXERCISE?

Research shows that maintaining a specific heart rate while exercising is the optimal way to monitor the intensity of a workout and to achieve maximum results. That is the idea behind the Life Fitness Heart Rate Zone Training® approach to exercise.

Zone Training identifies an exerciser's ideal heart rate range, or zone, for burning fat or increasing cardiovascular fitness. The zone is a percentage of the theoretical maximum (HRmax), and its value depends on the workout. The maximal heart rate formula is defined by the American College of Sports Medicine's "Guidelines for Exercise Testing and Prescription", 8th Edition, 2010. HRmax equals to 206.9 minus the total of 0.67 multiplied by a person's age.

$$\text{HR Max} = 206.9 - (0.67 * \text{age})$$

The Life Fitness Cross-Trainer features exclusive workouts designed to take full advantage of the benefits of Heart Rate Zone Training+ exercise:

- FAT BURN
- HEART RATE HILL™
- EXTREME HEART RATE™
- CARDIO
- HEART RATE INTERVAL™

Each workout offers different benefits, as discussed in Section 4 *The Workouts*.

Note: Consulting a fitness trainer is recommended for defining specific fitness goals and designing a workout program.

To change the target heart rate during a workout, use the LEVEL arrow keys.

To switch between programs during a workout, use the WORKOUT SELECTION keys.

The Heart Rate Zone Training® workout programs measure heart rate. Wear the optional Polar® telemetry heart rate chest strap, or grip the Lifepulse™ sensors, to enable the Cross-Trainer's on-board computer to monitor the heart rate during a workout. The computer automatically adjusts the resistance level to maintain the target heart rate based on the actual heart rate.

Age	Theoretical Maximum Heart Rate	65% (Fat Burn)	80% (Cardio)
10	200	130	160
20	194	126	155
30	187	121	149
40	180	117	144
50	173	113	139
60	167	108	133
70	160	104	128
80	153	100	123
90	147	95	117
99	141	91	112

Note: Reference the above chart for Theoretical Maximum Heart Rates and Target Heart Rates.

3.2 HEART RATE MONITORING

THE LIFEPUULSE™ DIGITAL HEART RATE MONITORING SYSTEM

The patented Lifepulse system sensors are the built-in heart rate monitoring system on the Life Fitness Cross-Trainer. For the most accurate reading possible, during a workout:

- Grasp the sensors (A) firmly.
- Hold each sensors at the vertical midpoint.
- Keep hands steady and in place.

The console displays the heart rate within 10 to 40 seconds after the user grasps the sensors. The following factors may affect a Lifepulse reading: incorrect hand placement on the sensors, upper body activity, lotion or dirt on hands, and excessive or insufficient pressure used when gripping the sensors.

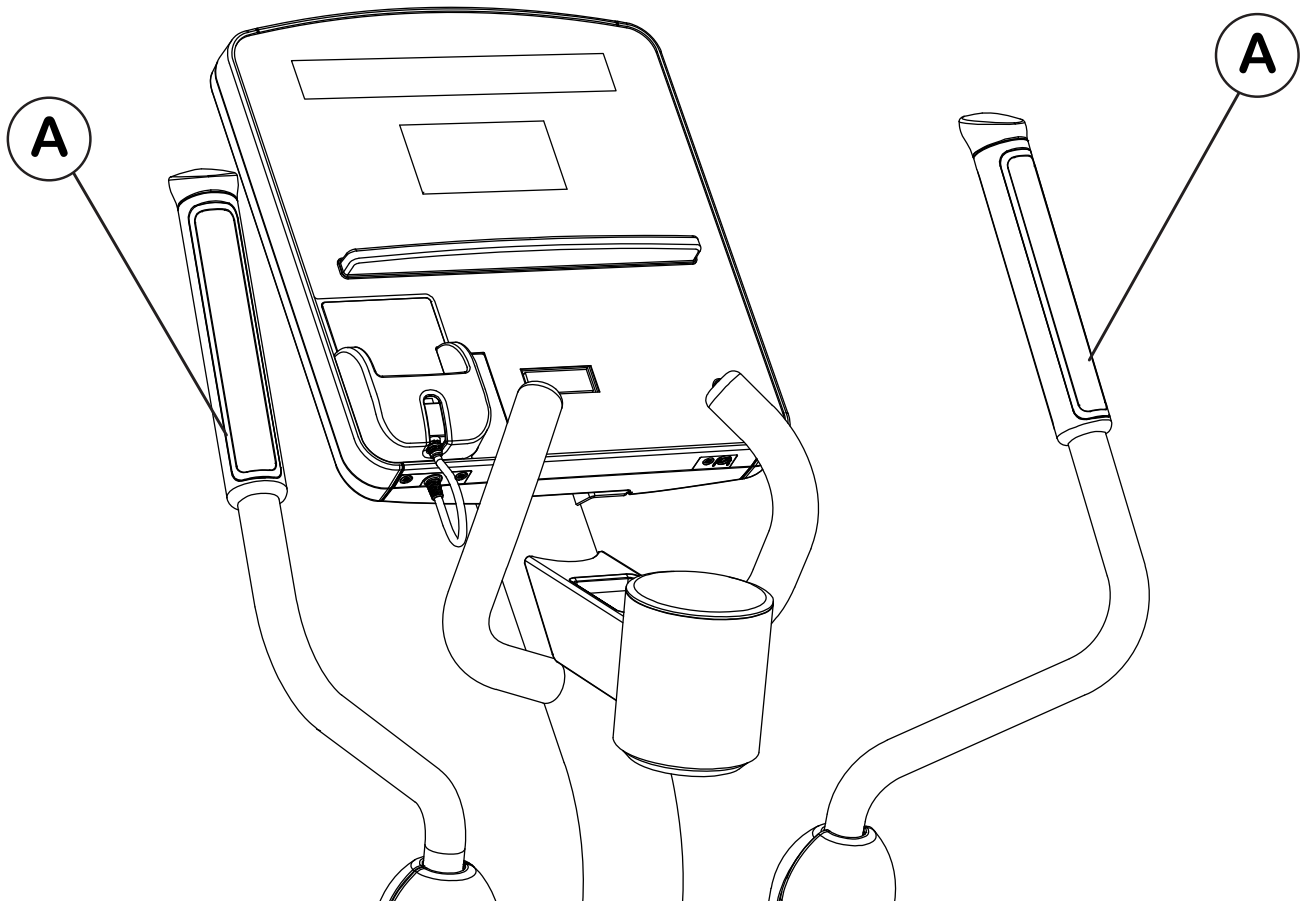

THE OPTIONAL POLAR® TELEMETRY HEART RATE CHEST STRAP

The Life Fitness Cross-Trainer is equipped with Polar® telemetry, a heart rate monitoring system in which electrodes, pressed against the skin, transfer heart rate signals to the console. These electrodes are attached to a Polar telemetry heart rate chest strap that the user wears during the workout. The Polar telemetry heart rate chest strap is optional. Contact Life Fitness Customer Support Services to order.

See the diagram below for correct positioning of the Polar telemetry heart rate chest strap. The electrodes (A), which are the two grooved surfaces on the underside of the strap, must remain wet to transmit accurately the electrical impulses of the heart back to the receiver. Moisten the electrodes. Then, secure the Polar telemetry heart rate chest strap as high under the chest muscles as possible. The strap should be snug, but comfortable enough to allow for normal breathing.

The transmitter strap delivers an optimal heart rate reading when the electrodes are in direct contact with bare skin. However, it functions properly through a thin layer of wet clothing.

If it becomes necessary to re-moisten the Polar telemetry heart rate chest strap electrodes, grasp the center of the strap, pull it away from the chest to expose the two electrodes, and re-moisten them.

Note: If the Lifepulse system sensors are grasped while the chest strap is worn, and if the signals from the sensors are valid, the on-board computer uses the sensor signals for calculating the heart rate instead of those transmitted with the Polar telemetry heart rate chest strap.

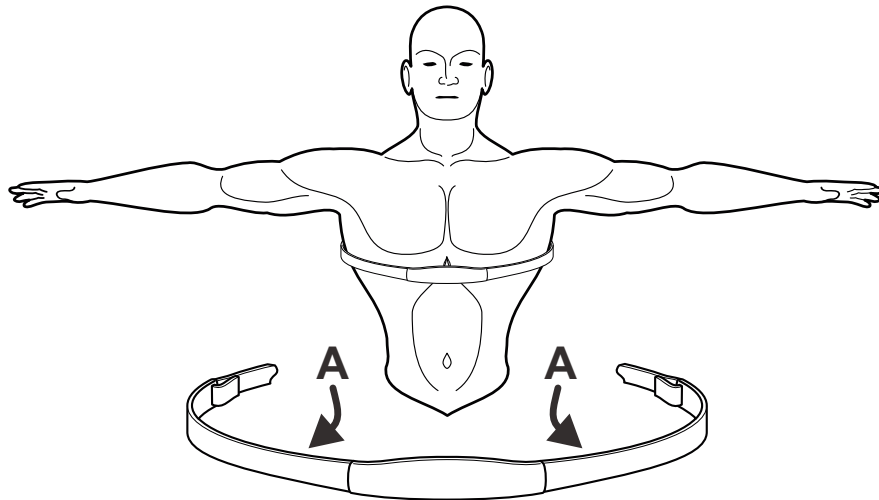

4 THE WORKOUTS

4.1 WORKOUT OVERVIEWS

This section lists the Life Fitness Cross-Trainer's pre-programmed workouts. For more detailed information, see Section 4.2, titled *Using the Workouts*. The following workouts are accessible via the ARROW keys.

QUICK START is the fastest way to begin exercising. After the QUICK START key is pressed, a constant-level workout begins. The intensity level does not change automatically.

MANUAL is a constant effort workout in which the user can change the intensity level at any time.

RANDOM is an interval training workout of constantly changing intensity levels that occur in no regular pattern or progression.

FAT BURN is a low-intensity workout for burning a higher percentage of calories from fat. The user wears a Polar telemetry heart rate chest strap, or grasps the Lifepulse™ sensors continuously. The program adjusts the intensity level, based on the actual heart rate, to maintain the rate at 65% of the theoretical maximum.

CARDIO is a higher intensity workout for more fit users, maximizing cardiovascular benefits and total calories burned. The user wears a Polar telemetry heart rate chest strap or grasps the Lifepulse™ sensors continuously. The program automatically adjusts the intensity level, based on the actual heart rate, to maintain the rate at 80% of the theoretical maximum.

HILL is an interval training workout. Intervals are periods of intense aerobic exercise separated by regular periods of lower-intensity exercise.

AROUND THE WORLD is an interval-training workout in which the hills resemble scenes of various geographical areas.

CASCADES is a two-peak workout in which intensity levels gradually increase and decrease.

FOOTHILLS is a rolling hill workout with low intensity levels.

INTERVAL is a HILL workout in which intensity levels rise and fall. The higher levels gradually incline toward a peak and then gradually decline.

KILIMANJARO is a HILL workout in which the intensity levels gradually incline toward one ultimate peak and then gradually decline.

SPEED TRAINING is a HILL workout in which the intensity level alternates between high and low levels very quickly to simulate a typical speed training workout.

HEART RATE HILL™ takes the user through three different hills based on the target heart rate. The user wears a Polar telemetry heart rate chest strap or grasps the Lifepulse™ sensors continuously.

HEART RATE INTERVAL™ alternates between a hill and a valley based on the target heart rate. The user wears a Polar telemetry heart rate chest strap or grasps the Lifepulse™ sensors continuously.

EXTREME HEART RATE™ is an intense workout for more experienced users. It is designed to get the heart rate up and down as quickly as possible. The user wears a Polar telemetry heart rate chest strap or grasps the Lifepulse™ sensors continuously.

LIFE FITNESS FIT TEST estimates cardiovascular fitness and can be used to monitor improvements in endurance every 4-6 weeks.

TOTAL BODY WORKOUT simulates the experience of working with a personal trainer. The MESSAGE CENTER displays prompts at different times to emphasize pushing, pulling, total body, lower body, speed changes, and forward / reverse motion. This versatile workout promotes maximum cross-training benefits.

LOWER BODY WORKOUT continuously alternates five minutes of forward motion with two minutes of backward motion to cross-train different muscle groups.

MY WORKOUTS is not a workout program but a feature that allows the user to pre-set up to seven workouts with personal setup information, such as age or level, and then store the workouts in the console memory.

SPORT TRAINING simulates an outdoor terrain by setting various resistance levels.

EZ RESISTANCE features a gradual, subtle increase in resistance, independent of the user's pedaling speed. A peak in resistance is followed by an equally subtle decrease in resistance.

4.2 USING THE WORKOUTS

This section provides detailed information on setting up and using workouts. For quick-reference setup steps, see the chart at the end of the section.

To BEGIN A WORKOUT

To mount the Life Fitness Cross-Trainer, grasp the handles and carefully step on the pedals. To dismount, step off the pedals while still holding the handles. Then let go of the handles. Press START or simply begin pedaling to activate the console. The MESSAGE CENTER displays the prompt: "SELECT WORKOUT USING ARROW KEYS OR PRESS QUICK START". If it displays a different message, press the CLEAR key twice rapidly.

SELECTING AND USING QUICK START

QUICK START is the fastest way to begin exercising and bypasses the steps of selecting a specific workout program. At the MESSAGE CENTER prompt to select a workout, press the QUICK START key. The workout begins at an intensity level that remains the same unless manually changed.

SELECTING A WORKOUT

For all workouts: When prompted to select a workout, use the ARROW KEYS or WORKOUT PROFILES key to scroll through the workout names as they appear in the MESSAGE CENTER. When the desired workout appears, press ENTER.

For MY WORKOUTS, once a workout is configured and saved, no further setup steps are necessary. For more information, see Section 4.4, titled *Using My Workouts Personal Programs*.

ENTERING WEIGHT

When prompted by the MESSAGE CENTER to enter weight, use the ARROW KEYS to increase or decrease the displayed weight to the correct value and press ENTER. The default weight is 150 pounds or 68 kilograms. The on-board computer calculates the number and rate of calories burned using the entered weight as well as the pedaling speed and resistance level.

ENTERING AGE

When prompted by the MESSAGE CENTER to enter age, use the ARROW KEYS to increase or decrease the displayed age to the correct value and press ENTER.

Life Fitness Cross-Trainer workout programs that set a target heart rate zone first calculate the user's theoretical maximum heart rate. The HRmax equals 206.9 minus the total of 0.67 multiplied by a person's age. The programs then calculate the target zone as a percentage of the theoretical maximum.

ENTERING TIME

When prompted by the MESSAGE CENTER to enter a time, use the ARROW keys to increase or decrease the displayed time to the desired value and press ENTER.

SELECTING AND ADJUSTING THE RESISTANCE LEVEL

When prompted by the MESSAGE CENTER, use the ARROW KEYS to increase or decrease the displayed intensity level or target heart rate to the desired value, and press ENTER. Adjust the level as needed or desired during the workout.

- Resistance level: The Life Fitness Cross-Trainer provides a selection of 25 resistance levels. The resistance level appears in the WORKOUT PROFILE window as rows of lights arranged in columns. Selecting a low intensity level at first is recommended. As physical conditioning improves, the levels can increase.
- Target heart rate: Programs that calculate a target heart rate base this number on the age of the user and the type of workout. The user accepts or adjusts the rate when setting up the workout. During the workout itself, the program reads the heart rate, which is transmitted via the Lifepulse system sensors or the Polar heart rate chest strap; and it uses this data to adjust the resistance. Manually raising the rate increases the intensity of the cardiovascular exercise.

SELECTING A WORKOUT MODE

Two workout mode options on the Life Fitness Cross-Trainer feature alternate ways to vary workouts.

- **Total Body Trainer:** This workout mode simulates the experience of working out with a trainer. Throughout the workout, the MESSAGE CENTER displays prompts to vary the workload and emphasize different muscle groups, such as upper- and lower-body. This feature can be used with any workout, except for **FAT BURN, CARDIO, HEART RATE HILL, HEART RATE INTERVAL, EXTREME HEART RATE, and EZ RESISTANCE**. To select it, press the TOTAL BODY TRAINER key.
- **Lower Body Trainer:** This workout mode continuously alternates five minutes of forward motion with two minutes of reverse motion, to exercise different leg muscles. This feature can be used with any workout, except for **FAT BURN, CARDIO, HEART RATE HILL, HEART RATE INTERVAL, EXTREME HEART RATE, and EZ RESISTANCE**. To select it, press the LOWER BODY Trainer key.

SWITCHING WORKOUTS "ON-THE-FLY"

It is possible, during a workout, to switch to another workout program. After a switch, the console retains all the progress information about the workout since its beginning. To change workouts "on-the-fly," press WORKOUT PROFILES key, and then select a new workout. This feature is available for all workouts, except **EZ RESISTANCE, AROUND THE WORLD, KILIMANJARO, INTERVAL, CASCADES, SPEED TRAINING, and FOOT HILLS**.

ENDING WORKOUTS EARLY

To end a workout before the pre-set duration expires, press CLEAR once. The MESSAGE CENTER then displays a workout summary, which includes the distance travelled, the total calories burned, and other statistics. Press CLEAR a second time and the MESSAGE CENTER displays “SELECT WORKOUT USING ARROW KEYS OR PRESS QUICK START” for a new workout.

PAUSING WORKOUTS

To pause a workout, simply stop pedaling. To continue the workout, resume pedaling. The pause duration lasts 60 seconds, after which, the MESSAGE CENTER displays the prompt: “SELECT WORKOUT USING ARROW KEYS OR PRESS QUICK START”.

Note: *In addition to stopping, users may also activate the PAUSE key once to pause workout data accumulation and pedal resistance. Press it again to resume workout.*

The chart below lists the steps for setting up each workout. Use the ARROW KEYS or WORKOUT PROFILES key to scroll through the workout names as they appear in the MESSAGE CENTER. When the desired workout appears, press ENTER.

QUICK START

Press QUICK START
Begin workout

MANUAL

Select MANUAL
Enter weight
Enter time
Select level
Begin workout

RANDOM

Select RANDOM
Enter weight
Enter time
Select level
Begin workout

FAT BURN

Select FAT BURN
Enter weight
Enter time
Enter age
Accept target heart rate
Begin workout

CARDIO

Select CARDIO
Enter weight
Enter time
Enter age
Accept target heart rate
Begin workout

HILL

Select HILL
Enter weight
Enter time
Select level
Begin workout

HEART RATE HILL™

Select HEART RATE HILL
Enter weight
Enter time
Enter age
Accept target heart rate
Begin workout

INTERVAL

Select INTERVAL
Enter weight
Enter time
Select level
Begin workout

HEART RATE INTERVAL™

Select HEART RATE
INTERVAL
Enter weight
Enter time
Enter age
Accept target heart rate
Begin workout

EXTREME HEART RATE™

Select EXTREME HEART RATE
Enter weight
Enter time
Enter age
Accept target heart rate
Begin workout

LIFE FITNESS FIT TEST

Select FIT TEST
Enter weight
Enter age
Enter gender
Select level
Begin workout

AROUND THE WORLD

Select AROUND THE WORLD
Enter weight
Enter time
Select level
Begin workout

CASCADES

Select CASCADES
Enter weight
Enter time
Select level
Begin workout

FOOTHILLS

Select FOOTHILLS
Enter weight
Enter time
Select level
Begin workout

KILIMANJARO

Select KILIMANJARO
Enter weight
Enter time
Select level
Begin workout

SPEED TRAINING

Select SPEED TRAINING
Enter weight
Enter time
Select level
Begin workout

LOWER BODY WORKOUT

Select LOWER BODY WORKOUT
Enter weight
Enter time
Select level
Begin workout

TOTAL BODY WORKOUT

Select TOTAL BODY WORK
OUT
Enter weight
Enter time
Select level
Begin workout

SPORT TRAINING

Select SPORT
TRAINING
Enter weight
Select time
Select level
Begin workout

EZ RESISTANCE

Select EZ RESISTANCE
Enter weight
Select time
Select level
Begin workout

4.3 WORKOUT DESCRIPTIONS

QUICK START

QUICK START is the fastest way to begin exercising and bypasses the steps of selecting a specific workout program. The intensity level for the workout is set automatically to Level 1 and remains the same unless manually changed. To change the level, use the UP and DOWN ARROW keys to enter a higher or lower level number.

MANUAL

The **MANUAL** program sets an intensity level that does not change automatically. While the workout is in progress, increase or lower the intensity level as desired using the ARROW keys.

RANDOM

The **RANDOM** program creates a terrain of hills and valleys that varies with each workout. More than one million different patterns are possible.

FAT BURN

The **FAT BURN** workout is designed to maintain a user's heart rate at 65% of the theoretical maximum (HRmax) for optimal results. Throughout the workout, the user wears a Polar telemetry heart rate chest strap or grasps the Lifepulse™ sensors. If the user is not wearing a Polar telemetry heart rate chest strap, the WORKOUT PROFILE WINDOW displays a heart shape, and the MESSAGE CENTER displays a prompt to grasp the sensors. The console continuously monitors and displays the heart rate, adjusting the intensity level of the Cross-Trainer to reach and maintain the target. This system eliminates over-training and under-training, and it maximizes the aerobic benefits of exercise by using the body's fat stores for fuel.

CARDIO

The **CARDIO** workout is virtually identical to **FAT BURN**, however the target heart rate is calculated at 80% of the theoretical maximum (HRmax). The higher target promotes cardiovascular improvement by placing a heavier workload on the heart muscle.

SPORT TRAINING™ WORKOUT

This workout sets different hills, or resistance levels, throughout the course. Each hill matches a progressive degree of difficulty. Hills last between 30 and 60 seconds, depending on the workout duration.

EZ RESISTANCE

In this workout, the gradual changes in resistance are extremely subtle, lowering perceived exertion. The changes in resistance also are independent of user's pedaling speed. The cardiovascular workout is effective, efficient, and enjoyable at the same time.

The workout consists of one hill. The user determines the height of the peak of this hill by selecting an intensity level during the setup. The higher the level selected, the higher the intensity at the entry point, which is the beginning of the workout, and the higher the intensity at the peak, which occurs after 75% of the workout is completed. After the peak is reached, the resistance gradually returns to the same intensity level as that of the entry point. See the chart below.

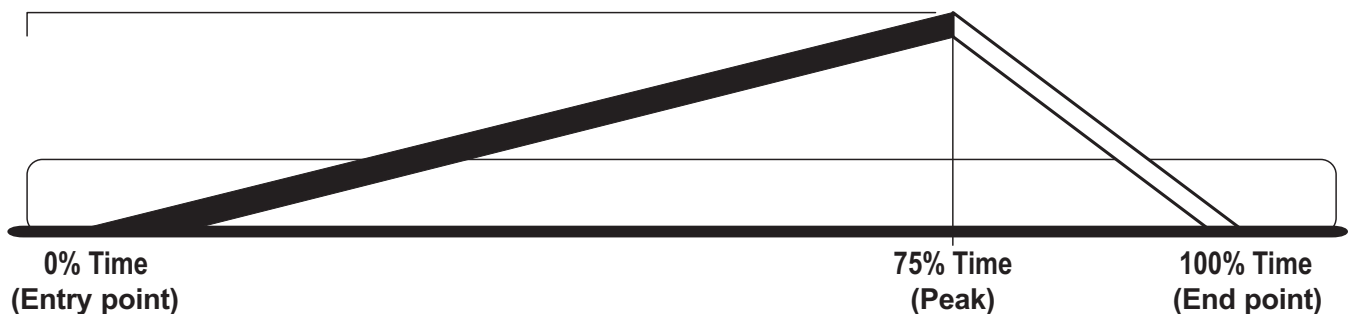

EZ Resistance Workout Profile

HILL

The Life Fitness-patented **HILL** workout offers a variety of configurations for interval training. Intervals are periods of intense cardiovascular exercise separated by regular periods of lower-intensity exercise. The **WORKOUT PROFILE** window represents these high and low intervals as columns of illuminated LEDs, which together have the appearance of hills and valleys. The computerized interval training workout has been scientifically demonstrated to promote greater cardiorespiratory improvement than steady-pace training.

The **HILL** workout goes through four phases, each marked by different intensity levels. The **WORKOUT PROFILE** window displays the progress of these phases. As noted in the descriptions below, the heart rate should be measured at two stages in the workout to gauge its effectiveness. Wear the Polar telemetry heart rate chest strap or continuously grip the Lifepulse™ handles. The **MESSAGE CENTER** does not display a request for a heart rate measurement, as it does with **CARDIO**, **FAT BURN** and the **HEART RATE ZONE TRAINING** programs.

1. **Warm-up** is a phase of low, gradually rising resistance, which brings the heart rate into the lower end of the target zone and increases respiration and blood flow to working muscles.
2. **Plateau** increases the intensity slightly and keeps it steady, to bring the heart rate to the low end of the target zone. Check the heart rate at the end of this phase.
3. **Interval Training** is a series of increasingly steeper hills alternating with valleys or stints of recovery. The heart rate should rise to the high end of the target zone. Check the heart rate at the end of this phase.
4. **Cool Down** is a low-intensity phase that allows the body to begin removing lactic acid and other exercise by-products which build up in muscles and contribute to soreness.

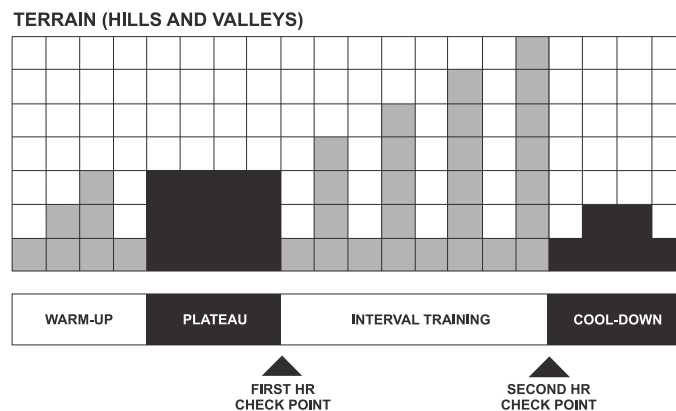

Each column, as seen in the **WORKOUT PROFILE WINDOW** and the chart above, represents one interval. The overall duration of the workout determines the length of each interval. Each workout is made up of 20 intervals, so the duration of each interval is equal to the duration of the entire workout divided by 20.

1 to 9 minutes: A workout with a duration of less than 10 minutes is insufficient for the **HILL** program to complete all four phases adequately. The program therefore condenses a workout of this duration at various stages.

10 to 19 minutes: The interval durations initially are set at 30 seconds for a 10-minute workout. For every minute over 10, each interval increases by three seconds. A 15-minute workout consists of 20 intervals at 45 seconds each.

20 to 99 minutes: All intervals last 60 seconds. If the user adds minutes to the pre-set duration while the workout is in progress, the program adds hills and valleys that are identical to the first eight intervals of the Interval Training phase. This pattern repeats until the workout is completed.

HEART RATE HILL™

This program combines the standard **HILL** workout profile with the concept of Heart Rate Zone Training. The default target heart rate is calculated as 80% of the theoretical maximum (HRmax), but the user can adjust the target rate during the workout setup. All hills and valleys are percentages of HRmax. The workout consists of three hills that target three heart rate goals:

- The first hill brings the heart rate to 70% of HRmax.
- The second hill increases the rate to 75% of HRmax.
- The third hill matches the Target Heart Rate bringing the heart rate to 80% of HRmax.

The valley is always defined as 65% of HRmax.

After a standard three-minute warm-up, the workout progresses toward the first hill and heart rate goal. Once the user reaches 70% of HRmax, the hill continues for one minute. When the minute expires, the level decreases into a valley. Once the user's heart rate falls to 65% of HRmax, the valley continues for one minute, then the next hill begins with its corresponding heart rate goal. After the user completes the third hill/valley pair, the program returns to the first hill and repeats the cycle as long as the duration allows. At the end of the duration, the workout goes into a cool down phase. If the heart rate goes above the theoretical maximum for more than 45 seconds, the Cross-Trainer automatically goes into pause mode. The program does not proceed to a new heart rate goal until the user reaches the current goal.

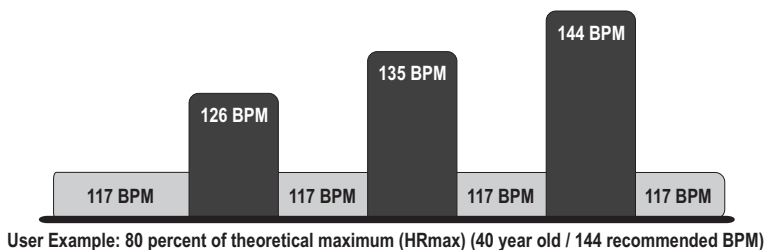
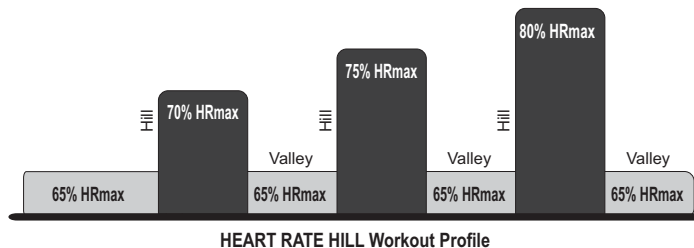

User Example: 80 percent of theoretical maximum (HRmax) (40 year old / 144 recommended BPM)

HEART RATE INTERVAL™

This program also combines the standard **HILL** workout profile with the concept of Heart Rate Zone Training. The default target heart rate is calculated as 80% of the theoretical maximum (HRmax), but the user can adjust the target rate during the workout setup. The workout alternates between a hill, which brings the heart rate up to the target rate of 80% of HRmax, and a valley which brings the heart rate down to 65% of HRmax. After a standard three-minute warm-up, the workout progresses toward the first hill and heart rate goal. Once the goal is reached, the hill continues for three minutes, then the level decreases into a valley. Once the 65% of HRmax goal is reached, the valley continues for three minutes, after which the next hill begins. The user's fitness level determines the number of hills and valleys encountered within the duration. At the end of the duration, the workout goes into a cool down phase. If the heart rate goes above the theoretical maximum for more than 45 seconds, the Cross-Trainer automatically goes into pause mode. The program does not proceed to a new heart rate goal until the user reaches the current goal.

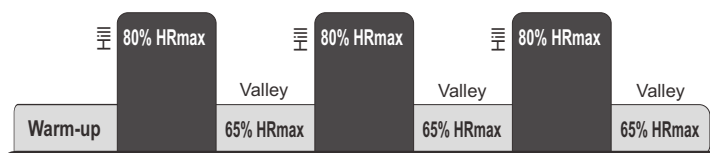

HEART RATE INTERVAL Workout Profile

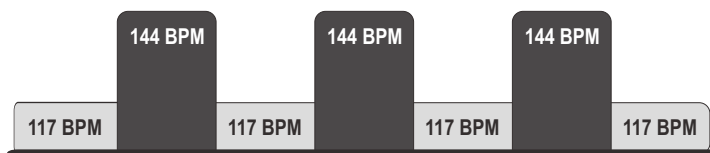

User Example: 80 percent of theoretical maximum (HRmax) (40 year old / 144 recommended BPM)

EXTREME HEART RATE™

This intense, varied workout is designed to help more experienced users to break through fitness improvement plateaus. The workout alternates between two target heart rates as quickly as possible. The effect is similar to that of running sprints. The user must wear a Polar telemetry heart rate chest strap or grip the Lifepulse™ sensors throughout the workout.

When setting up the workout, the user enters a target heart rate. After a standard three-minute warm-up, the intensity increases, until the user reaches the target heart rate goal of 85% of the theoretical maximum (HRmax). That target rate is maintained for a stabilizing period. Then, the intensity decreases. When the heart rate falls to the 65% of HRmax goal, it is maintained there for a stabilizing period. The program repeats the alternating intensity levels, continuing this pattern throughout the duration. The program does not proceed to a new heart rate goal until the user reaches the current goal.

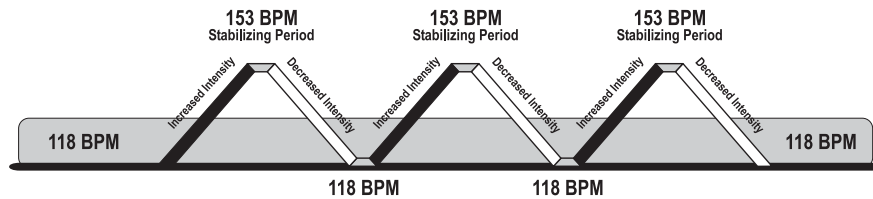
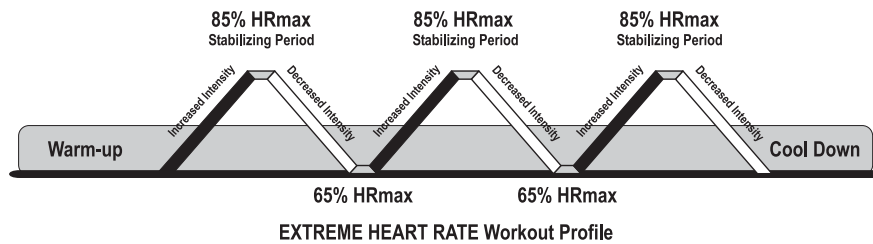

User Example 85 percent of theoretical maximum (HRmax) (40 year old / 153 recommended BPM)

SIX PRE-SET WORKOUTS

AROUND THE WORLD, CASCADES, FOOTHILLS, INTERVAL, KILIMANJARO, and SPEED TRAINING are variations of the HILL workout. These workouts cannot be changed “on the fly.”

AROUND THE WORLD is an interval-training workout in which the hills resemble scenes of various geographical areas.

CASCADES is a two-peak workout in which intensity levels gradually increase and decrease.

FOOTHILLS is a rolling hill workout with low intensity levels.

INTERVAL is a HILL workout in which intensity levels rise and fall. The higher levels gradually incline toward a peak and then gradually decline.

KILIMANJARO is a HILL workout in which the intensity levels gradually incline toward one ultimate peak and then gradually decline.

SPEED TRAINING is a HILL workout in which the intensity level alternates between high and low levels very quickly to simulate a typical speed training workout.

TOTAL BODY WORKOUT

During this workout, the MESSAGE CENTER displays prompts to emphasize different muscle groups. To emphasize upper-body muscles, the MESSAGE CENTER displays prompts to focus on pushing and pulling the moving arms at various times. To emphasize lower-body muscles, the MESSAGE CENTER displays prompts to rest the hands on the stationary handlebar, thus forcing the legs to do all the work. The program also alternates between forward and reverse motion as well as different speeds.

Ten seconds after prompting the user to change pedaling direction, the workout applies “braking resistance,” that is, a high resistance level that essentially forces the user to stop pedaling. Once the user stops pedaling, the workout resumes the normal resistance level. The actual level of braking resistance depends on the user’s pedaling RPM. If the user is pedaling at a rate equal to, or faster than, 65 RPM, the workout applies the maximum level of braking resistance. If the user is pedaling at a speed below 65 RPM, the workout applies 92% of the maximum.

TOTAL BODY WORKOUT is a constant-resistance workout. However, for a similar experience with a variable-resistance-level workout, the user can start any workout, except for **FAT BURN, CARDIO, HEART RATE HILL, HEART RATE INTERVAL, EXTREME HEART RATE, or EZ RESISTANCE**; and then press the TOTAL BODY TRAINER key.

LOWER BODY WORKOUT

During this workout, the MESSAGE CENTER displays alternating prompts to use pedal forward for five minutes and then backward motion for two minutes. This feature varies the emphasis on different leg muscles. Ten seconds after prompting the user to change pedaling direction, the workout applies “braking resistance,” that is, a high resistance level that essentially forces the user to stop pedaling. Once the user stops pedaling, the workout resumes the normal resistance level. The actual level of braking resistance depends on the user’s pedaling RPM. If the user is pedaling at a rate equal to, or faster than, 65 RPM, the workout applies the maximum level of braking resistance. If the user is pedaling at a speed below 65 RPM, the workout applies 92% of the maximum.

LOWER BODY WORKOUT is a constant-resistance workout. However, for a similar experience with a variable-resistance-level workout, the user can start any workout, except for **FAT BURN, CARDIO, HEART RATE HILL, HEART RATE INTERVAL, EXTREME HEART RATE, or EZ RESISTANCE**; and then press the LOWER BODY TRAINER key.

FIT TEST

The Life Fitness Cross-Trainer Fit Test program is another exclusive feature of this versatile Cross-Trainer. The Fit Test workout estimates cardiovascular fitness and can be used to monitor improvements in endurance every four to six weeks. The user must grasp the Lifepulse hand sensors when prompted or wear a heart rate chest strap, as the test score calculation is based on a heart rate reading. The workout duration will be five minutes at the chosen resistance level. Immediately afterward, the console will take the user's heart rate reading, calculate a fitness score, and display the score in the MESSAGE CENTER.

The Fit Test is considered to be a submax VO_2 (volume of oxygen) test. It gauges how well the heart supplies oxygenated blood to the exercising muscles, and how efficiently those muscles receive oxygen from the blood. Physicians and exercise physiologists generally regard this test as a good measure of aerobic capacity.

To set up the Fit Test:

- Begin pedaling.
- Press the WORKOUT PROFILES button repeatedly until the FIT TEST option appears in the message center. Press ENTER to select the FIT TEST option.
- The message center will prompt for a user weight (ENTER WEIGHT). Use the NUMERIC KEYS or UP/DOWN ARROW KEYS to input your weight. Press ENTER to accept the weight.
- The message center will next prompt for a user age (ENTER AGE). Use the NUMERIC KEYS or UP/DOWN ARROW KEYS to input your age. Press ENTER to accept the age.
- The message center will next prompt for a user gender (SELECT GENDER). Using the UP/DOWN ARROW KEYS, select a gender. Press ENTER to accept the gender selection.
- The message center will next prompt for a workout level (ENTER LEVEL). Consult the following recommended fit test level chart for an appropriate effort level based on your age, gender and activity level. Use the NUMERIC KEYS or UP/DOWN ARROW KEYS to enter the corresponding level.
- As the test continues, a message will prompt the user to maintain a pedaling rate between 50-60 rpm (equivalent to 4.2-5.5 mph). The user must maintain this rate throughout the 5-minute test duration. After 16 seconds, if 50-60 rpm is not maintained, the fit test will automatically terminate.

After the five-minute FIT TEST is completed, a FIT TEST score will be displayed.

FIT TEST PROGRAM SUGGESTED EXERTION LEVELS

	Inactive	Active	Very Active
Cross-Trainer	L2-4 men	L3-10 men	L7-15 men
Fit Test Level	L1-2 women	L2-5 women	L3-10 women

Suggested exertion levels should be used as a guideline for setting up the Fit Test program. The goal is to elevate the user's heart rate to a level that is between 60%-85% of their theoretical maximum heart rate.

Within each suggested range, these additional guidelines can be used:

Lower Half of Range	Upper Half of Range
higher age	lower age
lower weight	higher weight*
shorter	taller

* In cases of excessive weight, use lower half of range

The computer will not accept:

- heart rates less than 52 or greater than 200 beats per minute
- body weights less than 75 pounds (34 kg) or greater than 400 pounds (181 kg)
- ages below 10 or over 99 years
- data input that exceeds human potential

If you make an error when entering any Fit Test data, you can correct it by pressing CLEAR, inputting the correct information and pressing ENTER.

It is important for you to take the Fit Test under similar circumstances each time. Your heart rate is dependent on many factors, including:

- amount of sleep the previous night (at least seven hours is recommended)
- time of day
- time you last ate (two to four hours after the last meal is recommended)
- time since you last drank a liquid containing caffeine or alcohol, or smoked a cigarette (at least four hours is recommended)
- time since you last exercised (at least six hours is recommended)

For the most accurate Fit Test results, you should perform the Fit Test on three consecutive days and average the three scores.

Note: To receive a proper Fit Test score, the work done must be within a training heart rate zone that is 60% to 85% of the theoretical maximum heart rate (HRmax). This program requires a constant exertion for accuracy, so it will not be allowed to resume if paused. This program will control level. Manual adjustment of level is not permitted.

The tables below list fit test results

RELATIVE FITNESS CLASSIFICATION FOR MEN					
	Estimated VO ₂ Max (ml/kg/min) Per Age Category				
Rating	20-29	30-39	40-49	50-59	60+
Elite	55+	52+	51+	47+	43+
Excellent	53-54	50-51	49-50	45-46	41-42
Very Good	50-52	48-49	46-48	43-44	39-40
Above Average	45-49	43-47	42-45	39-42	35-38
Average	40-44	38-42	37-41	34-38	31-34
Below Average	38-39	36-37	34-36	32-33	29-30
Low	35-37	34-35	32-33	29-31	26-28
Very Low	<35	<34	<32	<29	<26

RELATIVE FITNESS CLASSIFICATION FOR WOMEN					
	Estimated VO ₂ Max (ml/kg/min) Per Age Category				
Rating	20-29	30-39	40-49	50-59	60+
Elite	47+	44+	42+	37+	35+
Excellent	45-46	42-43	40-41	35-36	33-34
Very Good	43-44	40-41	38-39	33-34	31-32
Above Average	38-42	36-39	34-37	30-32	27-30
Average	33-37	31-35	30-33	26-29	24-26
Below Average	31-32	29-30	28-29	24-25	22-23
Low	28-30	27-28	25-27	22-23	20-21
Very Low	<28	<27	<25	<22	<20

Life Fitness developed this rating scale based on VO₂ max percentile distributions referenced in *American College of Sports Medicine's Guidelines for Exercise Testing and Prescription* (8th E. 2010). It is designed to provide a qualitative description of a user's VO₂ max estimation, and a means of assessing initial fitness level and tracking improvement.

4.4 USING MY WORKOUTS PERSONAL PROGRAMS

The **MY WORKOUTS** personal programs feature on the Life Fitness Cross-Trainer makes it possible to pre-set up to seven workouts with personal setup information, such as age or duration, and then store the workouts in the console memory. MY WORKOUTS is used to store statistics for up to 7 different users of profiles. These workouts are accessed with the MY WORKOUTS key.

MY WORKOUTS allows the end-user to customize the set-up of a workout once and save it for quick start up. Any of the following workouts may be pre-set and stored: **FAT BURN, CARDIO, HEART RATE HILL, HEART RATE INTERVAL, EXTREME HEART RATE, HILL, RANDOM, MANUAL, SPORT TRAINING,** and **EZ RESISTANCE**. MY WORKOUTS allows the end-user to view workout statistics overtime applicable to each saved profile.

MY WORKOUTS - PROGRAMMING OPTIONS

Press the MY WORKOUTS key. Press the MY WORKOUTS key again to scroll through MY WORKOUTS. Press ENTER to select and start a MY WORKOUT. Press and hold the MY WORKOUTS key on the desired MY WORKOUT for editing options (this will only edit the selected MY WORKOUT). Press ENTER on one of the editing options: CHANGE NAME, CHANGE WORKOUT, or VIEW STATISTICS.

MY WORKOUTS - PROGRAMMING OPTIONS

Programmed Options	Description
NAME	Name of the user or profile, up to 16 characters
WORKOUT NAME	Choose a workout profile (ie. Random)
TIME	Duration of workout in minutes
WEIGHT	Weight of user in pounds or kilograms
AGE	Age of user in years
THR or LEVEL	Target Heart Rate for HeartSync™ workouts and resistance level for other profiles

MY WORKOUTS - PROGRAMMING THE NAME (CHANGE NAME)

Press the MY WORKOUTS key to scroll through all My Workouts. The default My Workouts names will be MY WORKOUT 1 through MY WORKOUT 7. Once the desired MY WORKOUT appears, press and hold the MY WORKOUTS key for editing options. The message center then displays USE ARROW KEYS TO SCROLL AND ENTER KEY TO SELECT EDIT OPTIONS. Scroll through the edit options by using the ARROW KEYS and press the ENTER key when CHANGE NAME appears. A name will appear with the first character blinking. To modify the first character simply press the UP or DOWN ARROW keys to scroll through all available characters. Once the desired character appears press the ENTER key to accept the character and then automatically move to the next character. When completed, press and hold the MY WORKOUTS key to save the profile name. The name will be saved and the display will return to EDIT OPTIONS.

The PAUSE/CLEAR key can be pressed at anytime to delete the current flashing character. In addition, when the first character is blinking the PAUSE/CLEAR key can be pressed to return the console to My Workouts EDIT OPTIONS.

If the PAUSE/CLEAR key is pressed while in My Workouts EDIT OPTIONS the console will return to idle mode. If no key is pressed within 30 seconds, the display will exit the programming mode and return to idle mode. No workout will be saved.

MY WORKOUTS - PROGRAMMING THE WORKOUT PROFILE (CHANGE WORKOUT)

Press the MY WORKOUTS key to scroll through all My Workouts. The default My Workouts names will be MY WORKOUT 1 through MY WORKOUT 7. Once the desired MY WORKOUT appears, press and hold the MY WORKOUTS key for editing options. The message center then displays USE ARROW KEYS TO SCROLL AND ENTER KEY TO SELECT EDIT OPTIONS. Scroll through the edit options by using the ARROW KEYS and press the ENTER key when CHANGE WORKOUT is displayed. The console will seem like it is now in normal workout set-up mode. Choose a workout and press the ENTER key. Set all other workout parameters such as time, weight, age, or target heart rate / level. If no key is pressed within 30 seconds, the display will exit the programming mode and return to idle mode. No workout will be saved.

MY WORKOUTS - VIEWING THE STATISTICS (VIEW STATISTICS)

Press the MY WORKOUTS key to scroll through all My Workouts. The default My Workouts names will be MY WORKOUT 1 through MY WORKOUT 7. Once the desired MY WORKOUT appears, press and hold the MY WORKOUTS key for editing options. The message center then displays USE ARROW KEYS TO SCROLL AND ENTER KEY TO SELECT EDIT OPTIONS. Scroll through the edit options by using the ARROW KEYS and press the ENTER key when VIEW STATISTICS is displayed. Press the ARROW KEYS to scroll through statistics including: Accumulated Time (hours), Accumulated Minutes (minutes combined with hours), Accumulated Calories, and Accumulated Distance. Press the MY WORKOUTS key at any time to exit statistics and return to My Workouts EDIT OPTIONS. If no key is pressed within 30 seconds, the display will exit the programming mode and return to idle mode. No workout will be saved.

5 SYSTEM MENU

A special system menu is available to Managers and other authorized personnel to allow access to certain Information, diagnostics tests and configuration settings.

5.1 ENTERING AND USING THE SYSTEM MENU

The System Menu consists of 3 submenus including the Information submenu, Diagnostic submenu and Configuration submenu. To enter the System Menu press and hold down the UP ARROW key and then press the CLEAR key twice. Continue to hold down the UP ARROW key until the MESSAGE CENTER displays the words CODE VER. X.XX. This is the Information menu which is the default submenu in the System Menu.

INFORMATION MENU (CODE VER X.XX)

The Information submenu will display information identifying the software version numbers and their associated part numbers as well as the version numbers of other installed software components. Use this menu when it is necessary to identify the version/part numbers installed on the product. The UP and DOWN arrow keys can be used to navigate through the list of items that may be displayed. Press the CLEAR key once to exit the Information Menu and hence the System Menu.

DIAGNOSTIC MENU (SERVICE MENU)

The Diagnostics submenu allows technicians to run system diagnostics. This menu can be entered from the Information Menu by pressing and holding the COOL DOWN key then pressing the ENTER key. The MESSAGE CENTER will display the words SERVICE MENU. Pressing the ENTER key will navigate forward through the list of diagnostic utilities while pressing the CLEAR key will navigate backward. Use the CLEAR key repeatedly to exit the Diagnostic Menu.

CONFIGURATION MENU (OPTIONAL SETTINGS)

The Configuration submenu allows the manager to configure options for the product. This menu can be entered from the Information Menu by pressing the ENTER key. The MESSAGE CENTER will display the words OPTIONAL SETTINGS. Pressing the ENTER key will navigate forward through the list of optional settings while pressing the CLEAR key will navigate backward. Use the CLEAR key repeatedly to exit the Configuration Menu. See the next page for a list of configuration options (Optional Settings).

5.2 MANAGER'S CONFIGURATION (OPTIONAL SETTINGS)

Setting	Default Value	Description
Maximum Workout Duration	60 Minutes	This feature allows the setting of maximum workout duration limits.
English / Metric Units	English (<i>International: Metric</i>)	This option sets the measurement unit type for weight, distance, and speed.
Pause Timeout	5 Minutes	This sets the maximum time during which a workout can remain in pause mode.
WATTS Display	Off (<i>International: On</i>)	If this option is enabled, the MESSAGE CENTER displays the Watts equivalent of the step rate.
METS Display	Off	If this option is enabled, the MESSAGE CENTER displays the METs equivalent of the step rate.
Calorie Per Hour (CPH) Display	On (<i>International: Off</i>)	If this option is enabled, the MESSAGE CENTER displays the number of calories burned per hour during the workout.
Sleep Mode	Off	The Sleep Time configuration setting controls how long the console will stay powered up from the last key press but before actively engaging the product in exercise. This configuration applies to externally powered products only. Upon entry to this utility the current configuration setting shall be displayed. The UP / DOWN arrow keys shall allow incrementing / decrementing of the Sleep Time value in 1 minute increments respectively. The range of values for Sleep Time shall be 1 through 99 minutes and OFF.
Language Select	Off	If this option is enabled, users can set the User Language. Choices include: English, German, French, Spanish, Italian, Dutch, and Russian.
iPod Video	Enable	This feature allows control over allowing iPod video tracks to be played on the Life Fitness Attachable TV, if present. If enabled by selecting the On setting, and an iPod video track is selected, the video shall be routed to the TV. Otherwise, the video shall not.
AUX Source	Off	This setting allows control over whether or not an optional CSAFE compatible audio device attached to the CSAFE connector shall be selectable as an audio source with the Source Select key.
TV GAIN	2	This setting allows control over the console earphone volume range for the Life Fitness Attachable TV Source. The range of settings are from 0 (Low) to 7 (High).

USER LANGUAGE SELECT

If enabled, this option allows users to select the language by which to interact with the unit during a workout.

To use the option, enable User Language Select (see below).

Begin pedaling. The console will display the message "SELECT LANGUAGE USING ARROW KEYS". The user can select from a list of available languages using any of the arrow keys. Press enter when the desired language appears to select that language. A workout can now be started using the selected language. Selecting a language is not necessary to begin a workout. Simply press the QUICK START key to start a workout or any of the program keys to begin workout programming using the default language.

The user may select from the following languages:

English, German, French, Italian, Dutch, Spanish, and Russian.

To enable the User Language Select option, enter the Optional Settings (see Section 5.1). Scroll forward through the options using the ENTER key, or backward, using the CLEAR key until LANGUAGE SEL appears. Once LANGUAGE SEL appears in the Message Center, press any of the UP/DOWN ARROW keys to toggle the mode from OFF to ON.

6 SERVICE AND TECHNICAL DATA

6.1 PREVENTIVE MAINTENANCE TIPS

The Life Fitness Cross-Trainer is backed by the engineering excellence and reliability of Life Fitness and is one of the most rugged and trouble-free pieces of exercise equipment on the market today. Commercial Life Fitness products are among the most popular of aerobic trainers in health clubs, colleges and military facilities the world over.

Note: *Safety of the equipment can be maintained only if the equipment is examined regularly for damage or wear. Keep the equipment out of use until defective parts are repaired or replaced. Pay special attention to parts that are subject to wear, as outlined below.*

REMARQUE: *pour conserver un matériel sûr, il convient de l'inspecter régulièrement afin de déceler tout signe d'usure ou d'endommagement. N'utilisez pas l'appareil tant que les pièces défectueuses n'ont pas été réparées ou remplacées. Portez une attention toute particulière aux pièces qui s'usent, comme indiqué ci-dessous.*

The following preventive maintenance tips will keep the Life Fitness Cross-Trainer operating at peak performance:

- Locate the Life Fitness Cross-Trainer in a cool, dry place.
- Clean the top surface of the pedals regularly.
- Keep the display console free of fingerprints and salt build-up caused by sweat.
- Clean the display console and all exterior surfaces with an approved or compatible cleaner (see *Life Fitness Approved Cleaners*) and a soft cotton cloth.
- Long fingernails may damage or scratch the surface of the console; use the pad of the finger to press the selection buttons on the console.
- Clean the housing and moving arms thoroughly on a regular basis.

LIFE FITNESS APPROVED CLEANERS

Two preferred cleaners have been approved by Life Fitness reliability experts: PureGreen 24 and Gym Wipes. Both cleaners will safely and effectively remove dirt, grime and sweat from equipment. PureGreen 24 and the Antibacterial Force formula of Gym Wipes are both disinfectants that are effective against MRSA and H1N1.

PureGreen 24 is available in a spray which is convenient for gym staff to use. Apply the spray to a microfiber cloth and wipe down the equipment. Use PureGreen 24 on the equipment for at least 2 minutes for general disinfection purposes and at least 10 minutes for fungus and viral control.

Gym Wipes are large, durable pre-moistened wipes to use on the equipment before and after workouts. Use Gym Wipes on the equipment for at least 2 minutes for general disinfection purposes.

Contact Customer Support Services to order these cleaners (1-800-351-3737 or email: customersupport@lifefitness.com).

LIFE FITNESS COMPATIBLE CLEANERS

Mild soap and water or a mild non-abrasive household cleaner can also be used to clean the display and all exterior surfaces. Use a soft cotton cloth only. Apply the cleaner to the cotton cloth before cleaning. DO NOT use ammonia or acid based cleaners. DO NOT use abrasive cleaners. DO NOT use paper towels. DO NOT apply cleaners directly to the equipment surfaces.

6.2 PREVENTIVE MAINTENANCE SCHEDULE

<i>ITEM</i>	<i>WEEKLY</i>	<i>MONTHLY</i>	<i>QUARTERLY</i>	<i>BI-ANNUALLY</i>	<i>ANNUALLY</i>
<i>Console Overlay</i>	<i>Clean</i>			<i>Inspect</i>	
<i>Accessory Trays</i>	<i>Clean</i>	<i>Inspect</i>			
<i>Frame</i>	<i>Clean</i>			<i>Inspect</i>	
<i>Plastic Covers</i>	<i>Clean</i>	<i>Inspect</i>		<i>Inspect</i>	
<i>Lifepulse Sensors</i>	<i>Clean / Inspect</i>				

6.3 TROUBLESHOOTING THE OPTIONAL POLAR® TELEMETRY HEART RATE CHEST STRAP

Malfunction	Probable Cause	Corrective Action
Heart rate reading is initially detected and functioning normally but then is lost.	Use of personal electronic devices, such as cell phones and portable MP3 players, causes external noise interference.	Remove the source of noise or reposition the exercise equipment.
	Equipment is in close proximity to other sources of noise such as audio/ video equipment, fans, two way radios, and high voltage/high current power lines.	
Heart rate readings are abnormally elevated.	Television sets and/or antennas generate electro-magnetic interference.	Move the Cross-Trainer a few inches away from the probable cause, or move the probable cause a few inches away from the Cross-Trainer, until the heart rate readings are accurate.
	Cell phones generate electromagnetic interference.	
	Computers generate electromagnetic interference.	
	Cars generate electromagnetic interference.	
	High voltage power lines generate electromagnetic interference.	
	Motor driven exercise equipment generates electro-magnetic interference.	
	Another heart rate transmitter within 3 feet (1 meter) generates electromagnetic interference.	

TROUBLESHOOTING THE OPTIONAL POLAR® TELEMETRY HEART RATE CHEST STRAP (CONTINUED)

Malfunction	Probable Cause	Corrective Action
Heart rate reading is erratic or absent entirely.	Belt transmitter electrodes are not wet enough to pick up accurate heart rate readings.	Wet the belt transmitter electrodes (see Section 3.2).
	Belt transmitter electrodes are not laying flat against the skin.	Ensure the belt transmitter electrodes are laying flat against the skin (see Section 3.2).
	Belt transmitter needs cleaning.	Wash the belt transmitter with mild soap and water.
	Belt transmitter is not within 3 feet (1 meter) of the heart rate receiver.	Make sure the chest strap transmitter is within 3 feet (1 meter) of the heart rate receiver.
	Polar telemetry heart rate chest strap battery is depleted.	Contact Life Fitness Customer Support Services for instructions on how to have the Polar telemetry heart rate chest strap replaced.
	Polar telemetry heart rate chest strap did not lock in with the heart rate receiver.	<p>Make sure the Polar telemetry heart rate chest strap is installed and move closer to the heart rate receiver. Wait up to 10 seconds for the heart rate to display on the console.</p> <p>Notes:</p> <ol style="list-style-type: none"> 1. Ensure proper adherence of the Polar telemetry heart rate chest strap to user's chest. 2. Ensure proper conductivity between the electrodes and user's chest. 3. If needed, use the Polar watch to verify chest strap's operation.

6.4 TROUBLESHOOTING THE IPOD®

Malfunction	Probable Cause	Corrective Action
Cannot control iPod using console keypad controls.	iPod is not fully connected due to interference with after market iPod protective cases.	Remove after market iPod protective case and reconnect.
Cannot hear iPod.	iPod paused.	Use iPod keypad controls on console to play a selection.
	Source selected is not currently set to iPod.	Press Source Select key until iPod is displayed.
	Mute key is pressed.	Press Mute key to unmute iPod source.
Cannot control iPod volume using console keypad controls.	Headphones are plugged into iPod instead of console headphone jack.	Plug headphones into console headphone jack.
	Volume control on iPod is being used with headphones plugged into console jack.	Use console iPod keypad volume controls.
Console displays a message that tells me to update my iPod firmware.	The iPod is not compatible due to its outdated firmware.	Visit www.apple.com for instructions on how to update your iPod device firmware.
Console displays a message that tells me "iPod COMMUNICATION TIMEOUT".	Use of older third generation (or earlier) iPod is not supported.	Use newer iPod model.
	iPod battery charge is extremely low.	Charge iPod to a minimum level before using.

TROUBLESHOOTING THE IPOD® (CONTINUED)

Malfunction	Probable Cause	Corrective Action
Cannot navigate iPod menus.	Use of console keypad controls to navigate iPod menus.	Use iPod controls to navigate menus and select playlists. Use console keypad controls to Play/Pause and to change volume and tracks.
Cannot control iPod volume using iPod slider ring.	Use of iPod slider ring controls to adjust iPod volume when headphones are plugged into the console jack.	Use console volume arrow keys to control volume.
No controls to change playlist on console.	Use of console keypad controls to change playlist on iPod.	Select playlist on iPod using iPod controls.

6.5 TROUBLESHOOTING THE LIFEPULSE SYSTEM SENSORS

If the heart rate reading is erratic or missing, do the following:

- Dry the hands if necessary to prevent slipping.
- Apply hands to all four sensors; two in each hand.
- Grasp the sensors firmly.
- Apply constant pressure around the sensors.

6.6 HOW TO OBTAIN PRODUCT SERVICE / SERIAL NUMBER LOCATION

1. Verify the symptom and review the operating instructions. The problem may be unfamiliarity with the product and its features and workouts.
2. Locate and write down the serial number of the unit which is located on the front stabilizer.
3. Contact Life Fitness Customer Support Services.

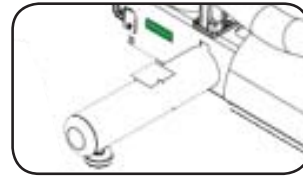
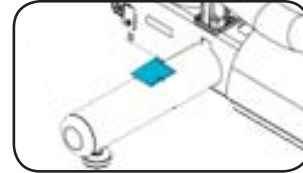

Remove plastic shroud to find small serial label location.

7 SPECIFICATIONS

7.1 LIFE FITNESS CSX CROSS-TRAINER SPECIFICATIONS

Designed use:	Heavy / Commercial
Maximum user weight:	350 pounds / 160 kilograms
Power requirements:	120 volt, 1.0 amp (U.S. & Canada); 100-240 volt, 1.0 amp (outside U.S. & Canada)
Console displays:	Elapsed time, total distance, total calories burned, calories burned per hour, heart rate, target heart rate, Watts, METS, workout profile, resistance level, speed
Workouts, goals, & modes:	Quick Start, Manual, Cardio, Fat Burn, Heart Rate Hill™, Heart Rate Interval™, Extreme Heart Rate™ Random, Hill, Time-Based Goal, Time in Zone Goal, Custom Workouts, My Workouts, Life Fitness Fit Test, Cool Down Mode, Speed Training, Around the World, Cascades, Foothills, Interval, Kilimanjaro, EZ Resistance, Sport Training, Total Body, Lower Body
Resistance levels:	25
Pedal speed range:	2.17 mph - 12.73 mph (3.49 kph - 20.49 kph)
Drive type:	Belt / alternator
Heart rate monitoring systems:	Patented Lifepulse™ digital contact heart rate and Polar® telemetry-compatible heart rate monitoring system
iPod power and charging:	5Vdc @ 500mA
iPod Compatibility:	Play / Pause Volume Control / Mute Previous Track / Next Track (Button Tap) Scan Forward / Scan Back (Button Hold)
Headphone jack:	3.5mm Stereo, 150mW max

Physical Dimensions	
Length:	81 ¾ in. (207.65 cm.)
Width:	28 in. (71.12 cm.)
Height:	65 in. (165 cm.) <i>with console</i>
Weight:	232 lbs. (105.24 kg.) 236 lbs. (107.05 kg.) <i>with console</i>
Shipping Dimensions (<i>without console</i>)	
Length:	80 in. (203 cm.)
Width:	28 in. (71 cm.)
Height:	47.5 in. (121 cm.)
Weight:	296 lbs. (134.27 kg.)

7.2 WARRANTY INFORMATION

WARRANTY COVERAGE: CSX CROSS-TRAINER

NOTE - Once any commercial product is placed in a private residence (home), it automatically becomes covered under that product category's consumer warranty. Warranty coverage begins at the original date of sale.

WHAT IS COVERED:

This Life Fitness consumer product ("Product") is warranted to be free of all defects in material and workmanship.

WHO IS COVERED:

The original purchaser or any person receiving the Product as a gift from the original purchaser.

HOW LONG IS IT COVERED:

All coverage is provided by specific Product according to the guidelines listed on the chart accompanying this warranty card.

WHO PAYS TRANSPORTATION & INSURANCE FOR SERVICE:

If the Product or any covered part must be returned to a service facility for repairs, **We, Life Fitness**, will pay all transportation and insurance charges for the first year. **You** are responsible for transportation and insurance charges during the second and third years (if applicable).

WHAT WE WILL DO TO CORRECT COVERED DEFECTS:

We will ship to you any new or rebuilt replacement part or component, or, at our option, replace the Product. Such replacement parts are warranted for the remaining portion of the original warranty period.

WHAT IS NOT COVERED:

Any failures or damage caused by unauthorized service, misuse, accident, negligence, improper assembly or installation, debris resulting from any construction activities in the Product's environment, rust or corrosion as a result of the Product's location, alterations or modifications without our written authorization or by failure on your part to use, operate and maintain the Product as set out in your Operation Manual ("Manual").

Two type RJ45 interchangeable Network ready and Fitness Entertainment ports are supplied with the Product. These ports comply with the FitLinxx CSAFE specification dated August 4, 2004 stating: 4.75VDC to 10VDC; maximum current of 85mA. Any Product damage caused by a load exceeding this FitLinxx CSAFE specification is not covered by warranty.

All terms of this warranty are void if this product is moved beyond the continental borders of the United States of America (excluding Alaska, Hawaii and Canada) and are then subject to the terms provided by that country's local authorized Life Fitness representative.

WHAT YOU MUST DO:

Retain proof of purchase (our receipt of the attached registration card assures registration of purchase information but is not required);

use, operate and maintain the Product as specified in the Manual;

notify Customer Support Services of any defect within 10 days after discovery of the defect; if instructed,

return any defective part for replacement or, if necessary, the entire Product for repair.

OPERATION MANUAL:

It is **VERY IMPORTANT THAT YOU READ THE MANUAL** before operating the Product. Remember to perform the periodic maintenance requirements specified in the Manual to assure proper operation and your continued satisfaction.

HOW TO GET REPLACEMENT PARTS & SERVICE:

Simply call Customer Support Services at **(800) 351-3737** or **(847) 451-0036**, Monday through Friday from 8:00 a.m. to 6:00 p.m. Central Standard Time, and tell them your name, address and the serial number of your product (refer to page 1 for Customer Services contact information). They will tell you how to get a replacement part, or, if necessary, arrange for service where your product is located or advise you on how and where to ship the product for service.

Before shipping:

1. **obtain** a Return Authorization Number (**RA#**) from Customer Support Services
2. securely **pack** your console (use the original shipping carton, if possible)
3. **write** the **RA#** on the outside of the carton
4. **insure** the console, and
5. **include** a letter explaining the defect or problem and a copy of your proof of purchase if you believe the service is covered by warranty

EXCLUSIVE WARRANTY:

THIS LIMITED WARRANTY IS IN LIEU OF ALL OTHER WARRANTIES OF ANY KIND EITHER EXPRESSED OR IMPLIED, INCLUDING BUT NOT LIMITED TO THE IMPLIED WARRANTIES OF MERCHANTABILITY AND FITNESS FOR A PARTICULAR PURPOSE, AND ALL OTHER OBLIGATIONS OR LIABILITIES ON OUR PART. We neither assume nor authorize any person to assure for us any other obligation or liability concerning the sale of this Product. Under no circumstances shall we be liable under this warranty, or otherwise, of any damage to any person or property, including any lost profits or lost savings, for any special, indirect, secondary, incidental or consequential damages of any nature arising out of the use of or inability to use this Product. Some states do not allow the exclusion or limitation of implied warranties or of liability for incidental or consequential damages, so the above limitations or exclusions may not apply to you.

CHANGES IN WARRANTY NOT AUTHORIZED:

No one is authorized to change, modify or extend the terms of this limited warranty.

EFFECT OF STATE LAWS:

This warranty gives you specific legal rights and you may have other rights which vary from state to state.

OUR PLEDGE TO YOU:

Our Products are designed and manufactured to the highest standards.

We want you completely satisfied with our Products and will do everything possible under the terms of this warranty to keep you secure in knowing you have bought the best!

MODEL	2 Years	1 Year	6 Months
CSX Cross- Trainer	✓ Electrical & Mechanical Parts	✓ Labor	✓ Console Overlay ✓