

# Life Cycle<sup>®</sup>

## 9500RHR

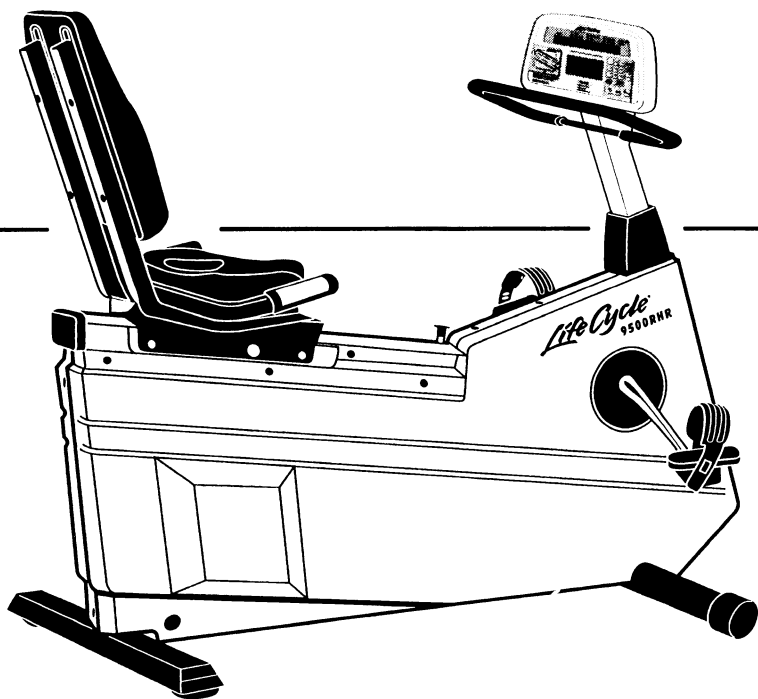

### AEROBIC TRAINER OPERATION MANUAL



# *Life Fitness*

*interactive fitness solutions*

---

## **Corporate Headquarters**

10601 West Belmont Avenue  
Franklin Park, Illinois 60131  
U.S.A.

(847) 288-3300 • FAX: (847) 288-3703  
(800) 735-3867 (Toll Free within the U.S. and Canada)

---

## **EUROPEAN OFFICES**

### ***Life Fitness Atlantic BV***

Atlantic Headquarters  
Columbusstraat 25  
3165 AC Rotterdam  
THE NETHERLANDS  
Telephone: (010) 494 5728  
FAX: (010) 494 5729

### ***Life Fitness GmbH***

Siemenstrasse 3  
85716 Unterschleissheim  
GERMANY  
Telephone: (089) 31 77 51-0  
FAX: (089) 3 10 73 69

### ***Life Fitness UK Ltd***

Queen Adelaide  
Ely, Cambs CB7 4UB  
UNITED KINGDOM  
Telephone: (01353) 666017  
FAX: (01353) 666018

### ***Life Fitness BeNeLux NV***

Lambrechtshoekenlaan 309-311  
B-2170 Antwerpen-Merksem  
BELGIUM  
Telephone: (03) 644 44 88  
FAX: (03) 644 24 80

### ***Life Fitness Italia S.R.L.***

Via, Elvas, 92  
39042 Bressanone (BZ)  
ITALY  
Telephone: (0472) 835470  
FAX: (0472) 835150

### ***Life Fitness Austria***

Schiesstattgasse 23  
A-2000 Stockerau  
AUSTRIA  
Telephone: (02266) 61959  
FAX: (02266) 61959



# TABLE OF CONTENTS

---

Introduction . . . . .	5
Safety Instructions . . . . .	6
How to Level the <b>Lifecycle® 9500RHR</b> Aerobic Trainer. . . . .	7
How to Adjust the Seat. . . . .	8
How to Adjust the Footstraps . . . . .	9
The Display Console . . . . .	10
Heart Rate Zone Training™ . . . . .	13
Operating Instructions & Program Descriptions . . . . .	15
<b>The Race Mode Option</b> . . . . .	16
<b>Fat Burn and Cardio Programs</b> . . . . .	18
<b>Random and Manual Programs</b> . . . . .	19
<b>Random Program</b> . . . . .	19
<b>Manual Program</b> . . . . .	19
<b>Hill Profile Program</b> . . . . .	20
<b>Fit Test Program</b> . . . . .	20
Optional Settings for the <b>Lifecycle 9500RHR</b> Aerobic Trainer. . . . .	26
Preventive Maintenance Tips . . . . .	27
How to Solve Basic Operating Problems. . . . .	28
How to Obtain Product Service. . . . .	29
<b>Lifecycle 9500RHR</b> Aerobic Trainer Specifications. . . . .	30





# INTRODUCTION

---

## ***Congratulations . . .***

And thank you for purchasing a **Lifecycle® 9500RHR** recumbent aerobic trainer. Your new Life Fitness aerobic trainer is the most versatile exercise bike ever developed, the culmination of over 20 years of Life Fitness research, technological innovation and engineering expertise. Lifecycle exercise bikes are recognized the world over as the most popular and advanced of computerized stationary bicycles.

Like other Life Fitness products, the **Lifecycle 9500RHR** aerobic trainer offers you a host of exclusive features designed to help you achieve your fitness goals faster and with greater enjoyment. Industry-standard workout programs, an array of up-to-the-second visual feedback, and the new Fat Burn and Cardio heart rate management programs are just a few of the benefits you'll enjoy on your **Lifecycle 9500RHR** aerobic trainer.

**Why use a Life Fitness aerobic trainer?** Aerobic training on a **Lifecycle 9500RHR** exercise bike is more than just a great workout. The **Lifecycle 9500RHR** aerobic trainer is ergonomically designed to deliver a comfortable workout, in a biomechanically superior seating position, and yet effortlessly guides you through your workout programs to aid you in reaching your intended goal.

The state-of-the-art, patented Lifepulse digital heart rate sensors make the new Cardio and Fat Burn programs the most effective workouts available on any aerobic trainer. And with features like the Race mode, Fit Test and level 0 resistance option that is almost 25% easier than the level 1 found on earlier editions of the classic Lifecycle aerobic trainer, you'll be much more likely to stick with your exercise plan and accomplish your goals.

If you have any questions regarding the operation of your **Lifecycle 9500RHR** aerobic trainer, please call **Life Fitness Customer Support Services** at (847) 451-0036 or toll free within the U.S. and Canada at (800) 351-3737. For product service in Europe, refer to the first page of this manual and contact your nearest Life Fitness

### **CAUTION:**

***Life Fitness STRONGLY recommends that if you are undertaking an exercise program you see your physician for a complete medical exam, particularly if you have a family history of high blood pressure or heart disease, are over the age of 45, or if you smoke, have high cholesterol, are obese, or have not exercised regularly in the past year.***

***If, at any time while exercising, you feel faint, dizzy, short of breath, or pain, stop immediately.***



## ***SAFETY INSTRUCTIONS***

---

### ***REMEMBER: SAFETY FIRST!***

- Always follow the console instructions for proper operation.
- Never operate a Life Fitness trainer if it has been dropped, damaged, or even partially immersed in water. Contact Life Fitness Customer Support Services.
- Never insert objects into any opening in your *Lifecycle 9500RHR* aerobic trainer. If an object should drop inside, carefully retrieve it; if you cannot reach the item, contact Life Fitness Customer Support Services.
- Never place liquids of any type directly on the unit, except in an accessory tray. Containers with lids are recommended.
- Do not use the *Lifecycle 9500RHR* aerobic trainer outdoors, near swimming pools or in areas of high humidity.
- Do not use the *Lifecycle 9500RHR* aerobic trainer in areas where aerosol spray products are being used or where oxygen is being administered. Such substances increase the danger of combustion and explosion.
- Keep all loose clothing, shoelaces, and towels away from the *Lifecycle 9500RHR* exercise bike pedals.
- Keep the area around your *Lifecycle 9500RHR* aerobic trainer clear of any obstructions, including walls and furniture.
- Always be careful and exercise caution when mounting or dismounting your *Lifecycle 9500RHR* aerobic trainer. Use the handlebar whenever additional stability is required.
- Wear shoes with rubber or high-traction soles. Do not use shoes with heels, leather soles, cleats or spikes. *Do not use the trainer in your bare feet.*
- Do not tip the *Lifecycle 9500RHR* aerobic trainer on its side during operation.

**NOTE: NEVER REMOVE THE STABILIZER BAR**

***SAVE THESE INSTRUCTIONS FOR FUTURE REFERENCE***





## ***HOW TO LEVEL THE LIFECYCLE 9500RHR AEROBIC TRAINER***

---

Depending on the surface you place your ***Lifecycle 9500RHR*** aerobic trainer on it may need to be leveled. After you place the bike where you will be primarily using it, check the stability of the bike by attempting to rock it back and forth. If it rocks, it isn't level. To level it, rotate the foot on the stabilizer bar that appears to be higher counter-clockwise (as viewed from above) with your finger until the bike is level.

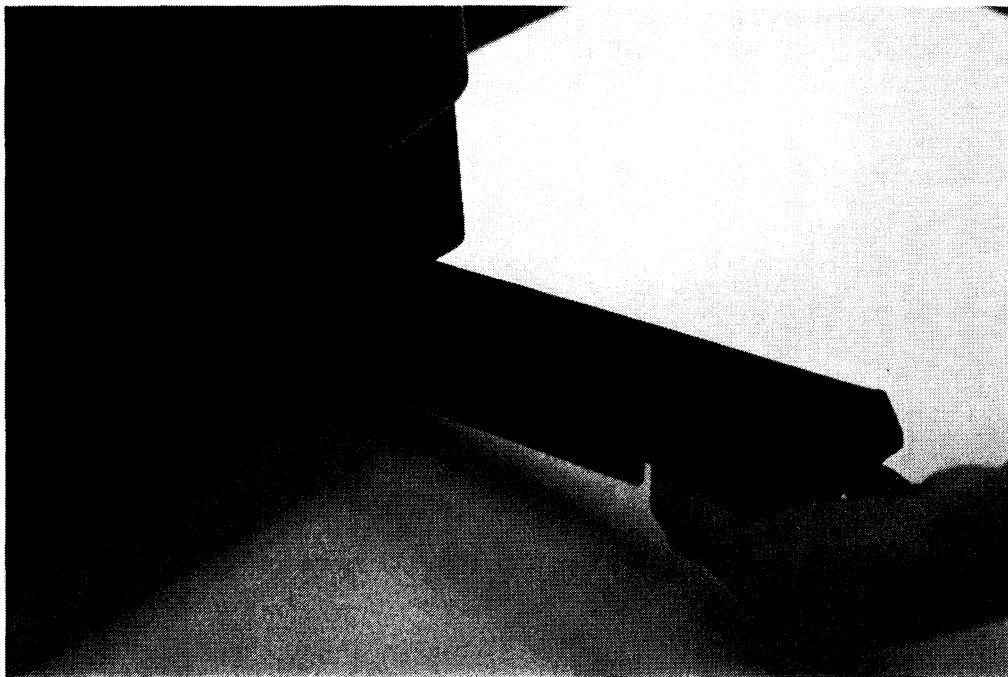

***Leveling the Lifecycle 9500RHR trainer***



## ***HOW TO ADJUST THE SEAT***

---

A properly adjusted seat is extremely important in any bike-oriented exercise activity, and the ***Lifecycle 9500RHR*** aerobic trainer is no exception. If the seat is too close, excessive strain will be placed on the knees and quadriceps muscles; if the seat is too far, the resulting reaching action will irritate the feet, ankles, hips and knees.

To adjust the seat properly, sit on it and place the balls of your feet on the pedals. An optimum position will allow you to move through the bottom of the stroke without locking your knees or shifting in the seat (your knees should have a slight bend at the point of fullest leg extension). If the seat needs to be adjusted pull the spring-loaded adjusting pin located on the extrusion in front of the seat. Slide the seat forward or backward as necessary to the proper position and release the pin to complete engagement. Gently slide the seat forward and backward a small distance to ensure it is locked into place. Check the seat distance again and readjust it if necessary.

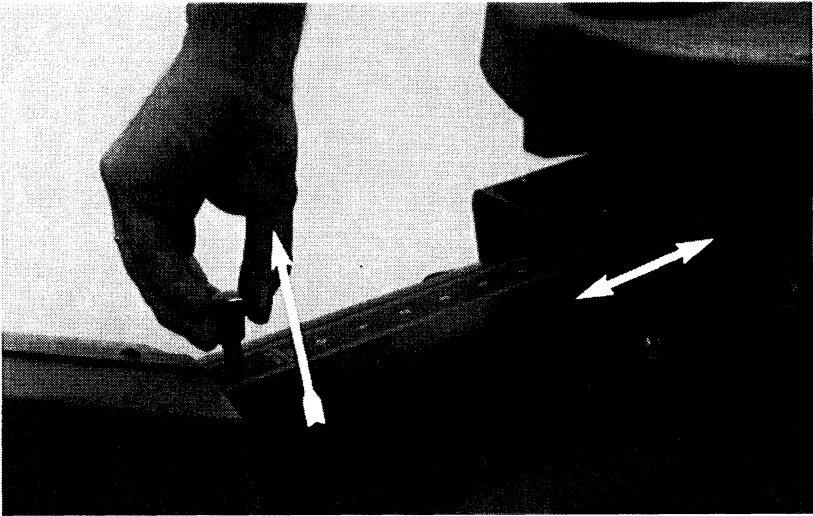

***Adjusting the seat***



***CAUTION: Do not attempt to adjust the seat while you are pedaling the bike. Doing so or failing to insert the seat pin completely may result in an uncomfortable workout or cause injury.***



## ***HOW TO ADJUST THE FOOTSTRAPS***

---

The pedals on your ***Lifecycle 9500RHR*** aerobic trainer have nylon-reinforced rubber footstraps with slits on both the inside and the outside of each strap. To adjust the width of the straps, grasp the outside of the strap and pull down and away from the knob. Once the slotted end is removed, choose a width that will feel the most comfortable while you are riding, reinsert the knob through the slot and pull the strap up. The strap will click when it locks in place.



***Adjusting the footstraps***



***CAUTION: Do not attempt to adjust the pedal footstraps while you are pedaling the bike. Doing so may result in an uncomfortable workout or cause injury.***



# THE DISPLAY CONSOLE

The **Lifecycle 9500RHR** aerobic trainer's display console is easy to use, and it allows you to follow your progress as you ride. The on-board computer lets you tailor your workouts to your individual fitness capabilities and goals while providing a unique means of measuring your fitness improvement from one workout to the next.

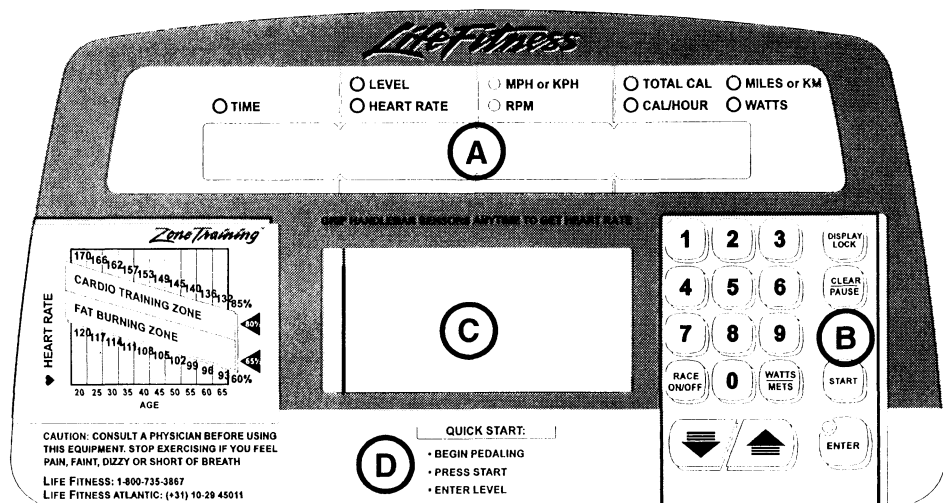

**The Display Console**

- A. MESSAGE CENTER:** Provides all the instructions for programming the Lifecycle 9500RHR trainer. In addition it displays elapsed time, level or heart rate, and speed. Total calories burned, calories per hour, distance traveled, MPH (in Race Mode), and Watts or METS (in Watts or METS Mode) are alternately displayed every 5 seconds. The alternating display can be locked on any one value by depressing the Display Lock key.
- B. DATA ENTRY ZONE:** Allows you to enter information required to set-up a workout or alter your current exercise program.
- **START:** The START key activates the display console after you begin pedaling and is then inactive for the remainder of the workout.
  - **▼▲ KEYS:** Use these keys to select all of your workout program parameters, including length of time of your ride, age, weight, gender, target heart rate and effort level. You can also increase or decrease your effort level at any time by pressing either of the ▼▲ keys (or change your target heart rate if you are in the Fat Burn or Cardio programs).



- **ENTER:** Actually *executes* the input of any information you have keyed in. It is not necessary to press ENTER when keying in a new effort level.
- **NUMERIC KEYS:** Use these keys to enter your riding time, level of difficulty and Heart Rate or Fit Test data. You can select a workout duration from 1 to 99† minutes. You may also enter a different resistance level than your current level, a different target heart rate for the Fat Burn and Cardio programs, or other data such as age, gender or weight via the numeric keypad.

- **CLEAR-PAUSE:** Use this key during programming to clear an erroneous value. Use this key to put your workout program on hold or restart it.

To place your workout on hold, **press the key once** and continue pedaling (remember, you are powering the machine; if you stop pedaling, all power is lost and the display will go blank). Pedal resistance drops to the minimum when the **Lifecycle 9500RHR** aerobic trainer is paused, and the stopwatch function is activated and the elapsed time window begins counting up from zero. Use this as a brief rest period if you feel fatigued or to take your heart rate.

**Press the key twice** to end your current program and show the program summary. **Press the key a third time** to clear the summary information and the Message Center Window prompts you to choose a program.

- **DISPLAY LOCK:** This button allows you to freeze the message center display on one set of feedback information - total calories, calories/hour, miles (kilometer), watts, etc. To unlock the display, simply push the Display Lock button again.
- **RACE ON / OFF:** Lets you toggle into and out of the Race mode at any time in the Hill, Random and Manual programs. The Speed / RPM display will toggle between RPM and MPH / KPH every five seconds. Your MPH will be dependent on your pedal speed and the level chosen. See the *Race Option information*.
- **WATTS / METS:** To display WATTS (roughly equal to 1/4 of calories per hour), press the WATTS / METS key once anytime during a program. During the Manual program, if you wish to enter a WATTS workload to maintain, press the ▼▲ keys or the numeric keypad while the WATTS value is being displayed.

To display METS (a measurement of oxygen consumption per unit of body weight), press WATTS/METS key twice. Next, key in your weight using the ▼▲ keys or the numeric keypad and press ENTER. During the Manual program, if you wish to enter a METS workload to maintain, enter that value using the ▼▲ keys or the numeric keypad (followed by the ENTER key) while the METS value is being displayed. Pressing the DISPLAY LOCK button while the WATTS or METS value is displayed will lock this value in the right-hand side display.

† Factory Setting for Maximum Program Duration is 60 minutes. See *Optional Settings for the Lifecycle 9500RHR Aerobic Trainer* section.



**C. PROGRAM PROFILE WINDOW:** Displays a matrix of lights showing your present position and upcoming terrain. The higher the column of lights the greater the resistance. The left-most column of lights represents your current position. The remaining columns show the upcoming terrain. As your workout progresses, the lights move across the screen from right to left.

In the Fat Burn and Cardio programs, a heart shape (♥) will be displayed in the window when you are required to grasp the Lifepulse sensors. A flashing heart will also appear at the conclusion of the Fit Test, again prompting you to grasp the Lifepulse sensors.

**D. QUICK START INSTRUCTIONS:** Tells you how to get right into a workout on your *Lifecycle 9500RHR* exercise bike. Just start pedaling, press start and enter an effort level using the numeric keypad!



## HEART RATE ZONE TRAINING™

Research shows that exercising within a specific heart rate range is the optimal way to both monitor your exercise intensity and achieve maximum results. That's the idea behind the Life Fitness Heart Rate Zone Training approach to exercise.

If your primary goal is to burn fat, you should exercise at a level between 60% and 75% of your theoretical maximum heart rate (defined by the American College of Sports Medicine's "Guidelines for Exercise Testing and Prescription" as 220 minus your age). If you wish to improve your cardiovascular condition, you should work out at 75% to 85% of your theoretical maximum heart rate.

**Example:** If you are 30 years old, your theoretical maximum heart rate is  $220 - 30$  (your age) = 190 beats per minute (bpm).

If your primary goal is *to burn fat*:

Multiply  $190 \times .60 = 114$  bpm (the low end of your target heart rate zone)

Multiply  $190 \times .75 = 143$  bpm (the high end of your target heart rate zone)

If your primary goal is *to improve your cardiovascular fitness*:

Multiply  $190 \times .75 = 143$  bpm (the low end of your target heart rate zone)

Multiply  $190 \times .85 = 162$  bpm (the high end of your target heart rate zone)

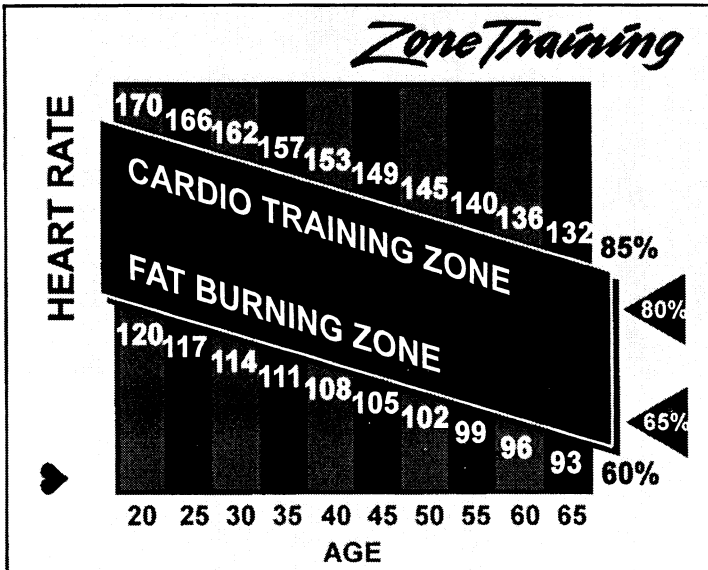

Heart Rate Zone Training chart



## ***HOW TO USE THE LIFEPULSE DIGITAL HEART RATE SENSORS***

The patented Lifepulse digital heart rate sensors are the heart rate monitoring system on the ***Lifecycle 950RHR*** exercise bike. To use the Lifepulse sensors, simply grasp the stainless steel sensors on the handlebars when the display console prompts you to do so or anytime you wish to check your heart rate. There are four sensors, two on each side of the handlebar, and you must make contact with all four to obtain your heart rate. The console will display your ECG-accurate heart rate in 10 to 30 seconds.





## **OPERATING INSTRUCTIONS & PROGRAM DESCRIPTIONS**

---

Selecting a workout program on your Life Fitness aerobic trainer is easy. Eight computerized aerobic workouts, including the exclusive Fat Burn, Cardio and Fit Test programs, are pre-programmed on your *Lifecycle 9500RHR* aerobic trainer:

<b>FAT BURN</b>	<b>HILL</b>	<b>MANUAL</b>	<b>WATTS</b>
<b>CARDIO</b>	<b>RANDOM</b>	<b>FIT TEST</b>	<b>METS</b>

**FAT BURN** is a Heart Rate Zone Training™ program designed to automatically maintain a target heart rate of 65% of your theoretical maximum heart rate. This lower intensity workout ensures that your heart rate is in an effective zone that will allow you to exercise longer.

**CARDIO** is a Heart Rate Zone Training™ program designed to increase cardiovascular fitness by automatically maintaining a target heart rate of 80% of your theoretical maximum heart rate.

**HILL** is an interval training workout consisting of a warm-up period followed by a plateau of constant effort, progressively more difficult levels of effort – or hills – separated by periods of recovery – or valleys – and a cool-down period.

**RANDOM** is a program of varying effort levels which occur randomly with each exercise session, resulting in more than one million workout combinations.

**MANUAL** maintains a constant effort level for the duration you select.

**WATTS** is a manual program which allows the user to set the workload value in WATTS.

**METS** is a manual program which allows the user to set the workload value in METS.

**FIT TEST** is a way of measuring your aerobic fitness level compared to others of the same age and gender.



The **Lifecycle 9500RHR** aerobic trainer is a “constant work” machine; in the Hill, Random and Manual programs, pedal resistance automatically compensates for changes in RPM. In other words, the slower you pedal, the greater the resistance; conversely, the faster you pedal the less resistance you feel<sup>1</sup>. The distance you travel will remain the same; pedaling faster will not bring you to the end of a program sooner nor burn more calories, assuring you of a consistent workout. If you prefer to be “rewarded” for going faster, try the *Race Mode Option*.

**NOTE:** Mileage readings are arbitrary and should not be used to compare workouts in different programs. Total calories burned is the best measure of the amount of work performed in any given workout.

<sup>1</sup>This is true as long as you pedal faster than 65 RPM. Below 65 RPM, the resistance will drop off to the point where you can continue pedaling at a pace sufficient to maintain power to the console.

### The Race Mode Option

Formerly a program in and of itself, the Race Mode now allows you to vary your pedal resistance to simulate the feel of an actual 12-speed racing bike in the Hill, Random and Manual programs. Turn the Race mode on at any time and the **Lifecycle 9500RHR** aerobic trainer’s 12 effort levels are transformed into the “gears” of a high performance road racing bicycle! The pedal resistance will change with the speed at which you pedal, enhancing your workout enjoyment while also allowing you greater control over the program’s intensity (the greater the resistance, the more LEDs will be illuminated). The distance you travel and the calories you burn during your workout will also vary with your pedal speed.



## ***TO BEGIN ANY LIFECYCLE 9500RHR AEROBIC TRAINER WORKOUT:***

- First adjust the seat position and make certain the seat pin is properly locked and the bike is level.
- Begin pedaling and press the START key.
- Select a workout program by pressing the ▼▲ keys until the program you want appears in the message center and then press ENTER (or wait 10 seconds and your selection will be automatically entered).
- You can “**Quick Start**” a Manual program workout without selecting a program. To do so, just begin pedaling, press START, and input an effort level, using the numeric keypad, between 0 (easiest) and 12 (most difficult).

<b>HILL</b>	<b>RANDOM</b>	<b>MANUAL OR FIT TEST</b>
<b>0</b>	<b>0</b>	<b>0</b>
<b>1-2</b>	<b>1-2</b>	<b>1</b>
<b>3-4</b>	<b>3</b>	<b>2</b>
<b>5-6</b>	<b>5</b>	<b>3</b>
<b>7-8</b>	<b>7</b>	<b>4</b>
<b>9-10</b>	<b>8-9</b>	<b>5</b>
<b>11</b>	<b>10</b>	<b>6</b>
<b>12</b>	<b>11</b>	<b>7</b>
	<b>12</b>	<b>8</b>
		<b>9</b>
		<b>10</b>
		<b>11</b>
		<b>12</b>

*Effort level equivalency table*

***REMEMBER – YOU CAN CHANGE EFFORT LEVELS AT ANY TIME  
DURING YOUR WORKOUT\* BY SIMPLY KEYING IN A NEW LEVEL  
ON THE KEYPAD OR THE ARROWS!***

\*Except in the Fat Burn and Cardio programs, in which you may change your target heart rate.



## **FAT BURN AND CARDIO PROGRAMS**

- Enter your age using the numeric keypad to receive your computed target heart rate. Press ENTER to accept the calculated target or input your own target heart rate using the keypad and press ENTER.
- The message center will prompt you to enter a time from 1 – 99 minutes (or the maximum time preprogrammed on unit). Key in the time you want your workout to last and press ENTER.
- Finally, select a warm-up effort level from 0 – 12. The effort level will be displayed in the Data Entry Window (you do not need to press ENTER) and your heart rate management program will begin a three minute warm-up at this level or until you reach your target heart rate, whichever comes first, followed by the actual heart rate controlled portion of the program.

The Fat Burn and Cardio heart rate management programs work by adjusting the resistance of the **Lifecycle 9500RHR** exercise bike in response to your heart rate. These two programs use the technology of the Lifepulse digital sensors to monitor your heart rate and automatically adjust the work load to maintain your target heart rate. The end result is a perfect workout every time, eliminating both under- and over-training.

On the **Lifecycle 9500RHR** aerobic trainer, the Fat Burn program will maintain your heart rate at 65% of your theoretical maximum heart rate (defined by the American College of Sports Medicine's "Guidelines for Exercise Testing and Prescription" as 220 minus your age), or another target heart rate that you enter. Pedal resistance will **automatically** adjust to maintain the target heart rate. Exercising at 65% of your theoretical maximum heart rate maximizes the aerobic benefits of exercise by accessing the body's fat stores for fuel and by allowing you to exercise longer.

The **Cardio** program is virtually identical to the Fat Burn program. The only difference is that your target heart rate is calculated at 80% of your theoretical maximum to accentuate cardiovascular improvement by placing a heavier work load on the heart muscle. If you wish to vary the focus of your exercise activities, once the warm-up is complete, you may switch back and forth between the Fat Burn and Cardio programs at any time during a workout simply by pressing the ENTER key, creating the **ultimate** interval training program!

Remember, you may change your target heart rate at any time **after** the warm-up period by simply keying in a new target heart rate or pressing the ▼▲ keys or toggling fat burn and cardio target heart rates using the ENTER key.

The Life Fitness Heart Rate Zone Training programs begin with a three minute warm-up period designed to safely get you closer to your target heart rate from a resting start. It should take two to three minutes for your heart rate to reach your target.



**NOTE:** *If your heart rate is above the chosen target during the warm-up period, the warm-up period will immediately end and the Lifecycle 9500RHR aerobic trainer will begin automatically varying its resistance to maintain your target heart rate.*

## **RANDOM AND MANUAL PROGRAMS**

- After selecting a workout, you will be asked to enter your desired workout time in minutes. Use the numeric keypad to input a number from 1-99 minutes (or the maximum time preprogrammed on unit) and press ENTER.
- Once you have selected either the Random or Manual program your workout will begin. All you need to do is choose an effort level between 0 (easiest) and 12 (hardest).

### ***Random Program***

The computer randomly selects hill and valley terrain which varies with each and every workout, resulting in more than one million combinations. Because resistance levels are greater in this program than in the Hill program, it is recommended that the Random program be set one or two levels *lower* than the level of intensity you would normally select on the Hill program.

### ***Manual Program***

The Manual program provides steady-pace exercise equal to that of the highest hill encountered on the Hill program at the same level of effort (except at level 0, when the resistance equals that of the lowest valley). Because of the greater resistance levels of this program, it is recommended that you set the Manual program about two to three levels *lower* than the level of effort that you would normally select on the Hill program.

You can design your own interval training program using the Manual program by varying the level of effort during the course of your workout. To do so, select a high level of resistance until you reach the upper end of your target heart rate zone, then ride at a lower effort level until your heart rate drops to the bottom of your target zone. Then increase the level of effort again until you are back to the upper portion of your target zone. By repeating this process, you will actually be creating your own hills and valleys.



## HILL PROGRAM

- After selecting a Hill workout, you will be asked to enter your desired workout time in minutes. Use the numeric keypad to input a number from 1-99 minutes (or the maximum time preprogrammed on unit) and press ENTER.
- Once you have selected the duration of your Hill workout the program will begin. Just choose an effort level between 0 (easiest) and 12 (hardest).

The **Lifecycle 9500RHR** aerobic trainer's patented Hill program offers the ideal configuration for interval training: periods of intense aerobic activity separated by regular intervals of lower-intensity exercise. Interval training programs have been scientifically demonstrated to yield greater cardiorespiratory improvement than steady-pace training.

Not only does the Hill program offer the challenge of alternating periods of high and low intensity, but the levels of intensity become progressively more difficult during the course of the program. Because you have the option of working out in a Hill program for anywhere from 1 to 99 minutes, and because the Hill program is composed of four distinct phases, the program must be structured differently to accommodate the entire array of program durations. Longer workouts add more hills.

***Each Hill program session comprises the following phases:  
(1) Warm-up, (2) Plateau, (3) Interval Training, and (4) Cool-down.***

- ***Warm-up:*** Gradually brings your heart rate into the lower portion of your target heart rate zone, increasing respiration and blood flow to working muscles.
- ***Plateau:*** Brings your heart rate into your target zone. Check your heart rate at the end of the plateau period to ensure that you have entered your target heart rate zone.
- ***Interval Training:*** A series of hills and valleys. During this portion of your workout, you will be confronted with sets of four successively steeper hills, each separated from the next by a valley, or recovery period. Check your heart rate at the end of the interval training period to ensure that you have stayed within your target zone.
- ***Cool-down:*** The cool-down allows your body to begin removing accumulated by-products of exercise, such as lactic acid, which build up in muscles during your workout and contribute to muscle soreness.



The Hill diagram below shows the effort level and recovery periods encountered during a Hill workout. Effort and recovery periods are simulated on the display console by columns of lights in the Program Profile window. The columns move from right to left during the workout. The higher the column, the greater the resistance; consequently, you must increase your effort.

### TERRAIN (HILLS AND VALLEYS)

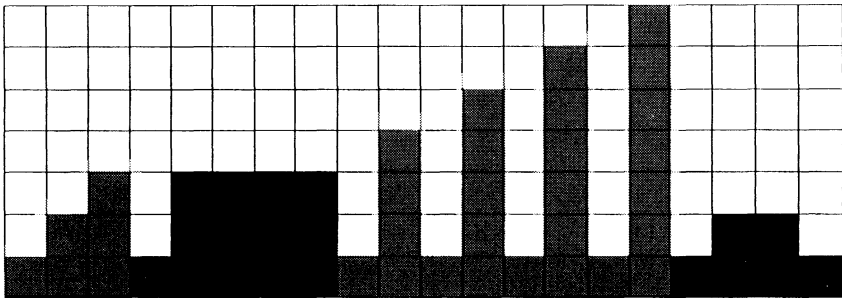

WARM-UP

PLATEAU

INTERVAL TRAINING

COOL-DOWN

FIRST HR  
CHECK POINT

SECOND HR  
CHECK POINT

### HEART RATE CHECK POINTS:

#### *For Fat Burning:*

- ✓ *First Heart Rate Check Point* — Your heart rate should be between 60% and 70% of the theoretical maximum heart rate for your age category.
- ✓ *Second Heart Rate Check Point* — Your heart rate should be between 70% and 75% of the theoretical maximum heart rate for your age category.

#### *For Cardio:*

- ✓ *First Heart Rate Check Point* — Your heart rate should be between 75% and 80% of the theoretical maximum for your age category.
- ✓ *Second Heart Rate Check Point* — Your heart rate should be between 80% and 85% of the theoretical maximum for your age category.

*Be sure to check your heart rate near the end of the plateau and interval training periods using the Lifepulse Sensors (see Hill diagram above). You should always take your heart rate at the times indicated to make sure you are staying within your target heart rate zone.*



## **FIT TEST PROGRAM**

The **Lifecycle 9500RHR** exercise bike Fit Test program is another exclusive feature of this versatile aerobic trainer. Your Fit Test score is also an approximate measure of your  $VO_2$  max; think of it as your relative fitness score. Use the Fit Test to monitor improvement in your endurance every four to six weeks.

- After selecting the Fit Test program using the ▼▲ keys, the message center will ask for your age (**ENTER AGE**). Use the numeric keys to input your age and press ENTER.
- After entering your age, you will be asked for your weight (**SELECT WEIGHT**). Use the ▼▲ keys or the numeric keys to input your weight and press ENTER.
- After entering your weight, the message center will prompt you to select your gender (**SELECT GENDER**). Press the ▼▲ keys to do so, ▲ for male or ▼ for female and then press ENTER.
- After selecting a gender the message center will prompt you to select a workout level (**SELECT LEVEL**). Consult the **Activity Levels** chart on the following page for the effort level you should input based on your age, gender and activity level. Use the numeric keys to enter the corresponding level.

After you have completed the five-minute Fit Test you will be prompted to grasp the Lifepulse sensors. After 20 to 30 seconds your Fit Test score and ranking will be displayed.





### RECOMMENDED FIT TEST LEVELS

<i>AGE (years)</i>	<i>WEIGHT</i>	<i>INACTIVE</i>	<i>ACTIVE</i>	<i>VERY ACTIVE</i>
<b>&lt; 30</b>	<b>&lt; 130</b>	<b>1</b>	<b>2</b>	<b>3</b>
	<b>131-169</b>	<b>2</b>	<b>3</b>	<b>4</b>
	<b>170-210</b>	<b>3</b>	<b>4</b>	<b>5</b>
	<b>&gt; 210</b>	<b>4</b>	<b>5</b>	<b>6</b>
<b>30-39</b>	<b>&lt; 130</b>	<b>0</b>	<b>1</b>	<b>2</b>
	<b>131-169</b>	<b>1</b>	<b>2</b>	<b>3</b>
	<b>170-210</b>	<b>2</b>	<b>3</b>	<b>4</b>
	<b>&gt; 210</b>	<b>3</b>	<b>4</b>	<b>5</b>
<b>40-49</b>	<b>&lt; 130</b>	<b>0</b>	<b>0</b>	<b>1</b>
	<b>131-169</b>	<b>1</b>	<b>1</b>	<b>2</b>
	<b>170-210</b>	<b>1</b>	<b>2</b>	<b>3</b>
	<b>&gt; 210</b>	<b>2</b>	<b>3</b>	<b>4</b>
<b>50 +</b>	<b>&lt; 130</b>	<b>0</b>	<b>0</b>	<b>0</b>
	<b>131-169</b>	<b>0</b>	<b>1</b>	<b>1</b>
	<b>170-210</b>	<b>1</b>	<b>1</b>	<b>2</b>
	<b>&gt; 210</b>	<b>1</b>	<b>2</b>	<b>3</b>

**NOTE:** The activity level values above have been based on a 170-pound (77-kilogram) man and a 125-pound (57-kilogram) woman. If your weight varies from these values substantially (i.e. less than 115 or more than 250 lbs), you may wish to increase or decrease the indicated levels accordingly.

If your heart rate is below 65% of your theoretical maximum heart rate at the conclusion of the Fit Test, retake the test at a higher level.

The Fit Test is an estimate of your submaximal  $VO_2$ , which is a measurement of how well the heart supplies oxygenated blood to the exercising muscles and how efficiently those muscles receive oxygen from the blood. This measurement is generally regarded by physicians and exercise physiologists as the standard for aerobic capacity.



## ***FIT TEST TIPS:***

*The computer will not accept:*

- heart rates less than 90 or greater than 199 beats per minute
- body weights less than 74 pounds (34 kg)  
or greater than 350 pounds (169 kg)
- ages below 10 or over 99 years
- data input that exceeds human potential

*If you make an error when entering any Fit Test data, you can correct it by pressing CLEAR-PAUSE, inputting the correct information, and pressing ENTER.*

*It is important for you to take the Fit Test under similar circumstances each time. Your heart rate is dependent on many factors, including:*

- amount of sleep the previous night (at least seven hours is recommended)
- time of day
- time you last ate (two to four hours after the last meal is recommended)
- time since you last drank a liquid containing caffeine or alcohol, or smoked a cigarette (at least four hours is recommended)
- time since you last exercised (at least six hours is recommended)

*For the most accurate Fit Test results, you should perform the Fit Test on three consecutive days and average the three scores.*

**NOTE:** *To receive a proper Fit Test score, you must be working within your training heart rate zone, which is 60%-85% of your theoretical maximum heart rate.*



**RELATIVE FITNESS CLASSIFICATIONS FOR MEN**

<b>RATING</b>	<b>AGE</b>				
	<b>20-29</b>	<b>30-39</b>	<b>40-49</b>	<b>50-59</b>	<b>60-69</b>
<i>Elite</i>	55+	52+	50+	48+	45+
<i>Excellent</i>	50-54	47-51	45-49	43-47	40-44
<i>Good</i>	45-49	42-46	40-44	38-42	35-39
<i>Above Average</i>	40-44	37-41	35-39	33-37	30-34
<i>Average</i>	36-39	33-36	31-34	29-32	26-29
<i>Below Average</i>	31-35	28-32	26-30	24-28	21-25
<i>Poor</i>	26-30	23-27	20-25	18-23	16-20
<i>Very Poor</i>	<26	<23	<20	<18	<16

**RELATIVE FITNESS CLASSIFICATIONS FOR WOMEN**

<b>RATING</b>	<b>AGE</b>				
	<b>20-29</b>	<b>30-39</b>	<b>40-49</b>	<b>50-59</b>	<b>60-69</b>
<i>Elite</i>	49+	46+	44+	42+	40+
<i>Excellent</i>	44-48	41-45	39-43	37-41	35-39
<i>Good</i>	39-43	36-40	34-38	32-36	30-34
<i>Above Average</i>	34-38	31-35	29-33	27-31	25-29
<i>Average</i>	30-33	27-30	25-28	23-26	21-24
<i>Below Average</i>	25-29	22-26	20-24	18-22	16-20
<i>Poor</i>	20-24	17-21	15-19	13-17	11-15
<i>Very Poor</i>	<20	<17	<15	<13	<11

**Fit Test Scoring Tables**



# OPTIONAL SETTINGS FOR THE LIFECYCLE 9500RHR AEROBIC TRAINER

---

## ● *Maximum program time*

The maximum program time option allows the maximum program time to be changed from the default maximum time limit of 60 minutes to anywhere from 1 to 99 minutes. Altering the maximum program time will affect all programs **except** the Fit Test. To change the **Lifecycle 9500RHR** aerobic trainer maximum program time, proceed as follows:

1. Press and hold the **5** key on the numeric keypad.
2. Begin pedaling (you must reach a minimum of 55 RPM), then press **START**.

All LEDs and 14-segment displays will be illuminated. This is called **Diagnostic State 1**. There are nine distinct Diagnostic States and the maximum program time default settings reside in **Diagnostic State 5**. Each time you press the **ENTER** key you will advance one diagnostic state. Continue to advance to **Diagnostic State 5**.

3. When you reach **Diagnostic State 5**, the current **MAXIMUM PROGRAM TIME** setting will be displayed. The default maximum program time is 60 minutes.
4. Use the **1** key or **▼** key to decrease the **MAXIMUM PROGRAM TIME** or the **3** key or **▲** key to increase the **MAXIMUM PROGRAM TIME**.
5. To exit the Diagnostic States, press the **CLEAR/PAUSE** key repeatedly until you return to the user display. The user display is the initial display console you see when you approach the unit for normal operation.

## ● *English/metric conversion*

The factory default is set to english measurement. When you reach **Diagnostic State 7** (see above), the Data Entry Window will display **ENGLISH** to designate english units. To change the default to metric measurement, press the '5' key and the system will toggle between english and metric units and display **METRIC**.

For more information on the other seven Diagnostic States please refer to the **Lifecycle 9500RHR Service Manual** available from Life Fitness Customer Support Services. (See *How To Obtain Product Service* for information on how they can be reached.)



## ***PREVENTIVE MAINTENANCE TIPS***

---

Your ***Lifecycle 9500RHR*** aerobic trainer is backed by the engineering excellence of Life Fitness and is one of the most rugged and trouble-free pieces of exercise equipment on the market today. Commercial Life Fitness exercise bikes are among the most popular of aerobic trainers, regularly standing up to marathon use — 18 hours a day, 7 days a week — in health clubs, colleges and military facilities the world over. This same technology and engineering expertise has gone into your ***Lifecycle 9500RHR*** aerobic trainer.

Here are some preventive maintenance tips that will keep your ***Lifecycle 9500RHR*** exercise bike operating at peak performance:

- Locate your ***Recumbent Lifecycle 9500RHR*** aerobic trainer in a cool, dry place.
- Clean the seat surface regularly.
- Clean the seat extrusion with a soft cloth and a non-abrasive liquid cleanser and check the seat adjustment pin insertion monthly.
- Keep the display console and Lifepulse sensors free of fingerprints and salt build-up caused by sweat. Use a 100% cotton cloth lightly moistened with water and a mild liquid detergent (other fabrics or paper towels may scratch the surface).
- Long fingernails may scratch the surface of the console. Use the pad of your fingertip to press the console buttons.



# HOW TO SOLVE BASIC OPERATING PROBLEMS

Symptom	Probable Cause	Corrective Action
<b>No Power</b>	<ul style="list-style-type: none"> <li>• 6 volt battery voltage too low</li> <li>• Harness not connected</li> <li>• Low RPMs</li> </ul>	<ul style="list-style-type: none"> <li>• Replace 6-volt battery</li> <li>• Disconnect and reconnect harness</li> <li>• Pedal at 40 RPM min.</li> </ul>
<b>Difficult to pedal</b>	<ul style="list-style-type: none"> <li>• 10- to 15-hour break-in period not complete</li> <li>• Selected level of difficulty too high</li> </ul>	<ul style="list-style-type: none"> <li>• Ride the bike for 10 to 15 hours</li> <li>• Lower the level of difficulty</li> </ul>
<b>Bike shuts off during ride</b>	<ul style="list-style-type: none"> <li>• Not entering desired workout duration</li> <li>• Low RPMs</li> </ul>	<ul style="list-style-type: none"> <li>• Check that desired workout duration appears in display window prior to pressing ENTER</li> <li>• Pedal at 40 RPM min.</li> </ul>
<b>Display flickers or fades in and out</b>	<ul style="list-style-type: none"> <li>• Wire harness connector loose</li> <li>• Low RPMs</li> </ul>	<ul style="list-style-type: none"> <li>• Carefully remove console and disconnect then reconnect the 10-pin connector</li> <li>• Pedal at 40 RPM min.</li> </ul>



# HOW TO OBTAIN PRODUCT SERVICE

## Step 1

Verify the symptom and review the operating instructions and **How To Solve Basic Operating Problems** on the previous page. The problem may be unfamiliarity with your **Lifecycle 9500RHR** aerobic trainer's features and programs.

## Step 2

Locate and document the serial number of the unit, which is located on the underside of the bike, just behind the front stabilizer bar.

## Step 3

Contact: **Life Fitness Customer Support Services:**

### **Life Fitness Customer Support Services**

10601 West Belmont Avenue  
Franklin Park, IL 60131  
Telephone: (800) 351-3737  
Toll Free within the U.S. and Canada)  
Telephone: (847) 451-0036  
Facsimile: (847) 288-3702

### **For Product Service In Europe:**

#### **Life Fitness GmbH**

Telephone: (089) 31 77 51-0  
Facsimile: (089) 3 10 73 69

#### **Life Fitness BeNeLux**

Telephone: (03) 644 44 88  
Facsimile: (03) 644 24 80

#### **Life Fitness Austria**

Telephone: (02266) 61959  
Facsimile: (02266) 61959

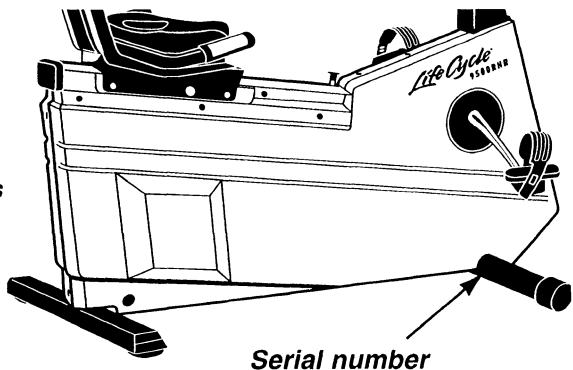

#### **Life Fitness UK Ltd**

Telephone: (01353) 666017  
Facsimile: (01353) 666018

#### **Life Fitness Italia S.R.L.**

Telephone: (0472) 835470  
Facsimile: (0472) 833150

Please have the serial number of your **Lifecycle 9500RHR** aerobic trainer and the problem/symptom ready for the Customer Support Services Specialist who will be assisting you. This information is necessary for us to help solve any problems you may be having.



# LIFECYCLE 9500RHR AEROBIC TRAINER

## SPECIFICATIONS

---

<b>Designed use</b>	Commercial
<b>Maximum user weight</b>	350 pounds / 159 kilograms
<b>Power requirements</b>	None
<b>Programs</b>	Hill, Random, Manual, Cardio, Fat Burn, Fit Test, Watts, METS
<b>Console displays</b>	Effort level, MPH or KPH (Race Mode), Total Calories Burned, Distance Traveled (miles or kilometers), Elapsed Time, Heart Rate, Pedal RPM, Calories per Hour, and Watts and/or METS
<b>Heart Rate monitoring system</b>	Patented Lifepulse digital heart rate sensors

### PHYSICAL DIMENSIONS:

<b>Length</b>	52 inches / 132 centimeters
<b>Width</b>	25 inches / 64 centimeters
<b>Height</b>	48 inches / 122 centimeters
<b>Weight</b>	128 pounds / 58 kilograms
<b>Color</b>	Medium grey with Black Accents

### SHIPPING DIMENSIONS:

<b>Length</b>	57 inches / 145 centimeters
<b>Width</b>	29 inches / 74 centimeters
<b>Height</b>	44 inches / 112 centimeters
<b>Weight</b>	159 pounds / 72 kilograms













**M051-00K19-A043**

***LifeFitness***

**10601 West Belmont Avenue  
Franklin Park, IL 60131**