

Communicate via **Micro network**



**Micronet**<sup>®</sup>  
Making Communication Easier

User's Manual

# 24-port 10/100Mbps Layer 2 Managed Switch

Model No.: SP1658C



# Table of Contents

<b>1. Introduction</b> .....	<b>4</b>
1.1 Package Contents .....	4
1.2 Feature .....	4
1.3 Hardware Specification .....	5
1.4 Environments Specification.....	7
1.5 Standard Conformance.....	7
1.6 How to Use this Guide .....	8
<b>2. Installation</b> .....	<b>9</b>
2.1 Product Description Overview.....	9
2.2 Switch Overview .....	9
2.3 LED Function .....	10
2.4 Reset Button .....	11
2.5 Installing the Switch .....	11
2.6 Rack- Mount Placement.....	13
<b>3. Configuration</b> .....	<b>15</b>
3.1 Web-based configuration .....	16
3.2 Command Line Interface (by Console or Telnet) .....	42
3.3 Privileged Mode commands.....	43
3.4 Global Config mode commands.....	50
3.5 Interface Config mode commands .....	66
<b>4. Specifications</b> .....	<b>70</b>
4.1 Cable specifications .....	70
4.2 Technical specifications .....	72
<b>5 Warranty statement</b> .....	<b>73</b>

## Notes and Cautions

A  **NOTE** indicates important information that helps you make better use of your device.

A  **NOTICE** indicates either potential damage to hardware or loss of data and tells you how to avoid the problem.



A  **CAUTION** indicates a potential for property damage, personal injury, or death.

# 1. Introduction

Micronet SP1658C 10/100Mbps Layer 2 Managed Switch offers high performance and a full set of layer 2 networking management features at an affordable cost, suitable for high performance workgroups and server applications. With 10/100Mbps RJ-45 ports and shared mini-GBIC slots for fiber optic connection, it delivers maximum throughput to high performance users or provides a backbone to a growing business network.

## 1.1 Package Contents

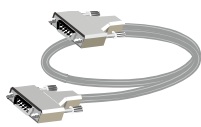
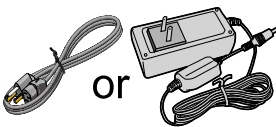
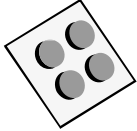
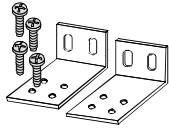
Package contains the following:

		
SP1658C switch	RS-232 cable	Power cord or adapter
		
Rubber feet	Brackets	CD for user manual and utilities

If any of the listed items is missing or damaged, please contact the place of purchase for a replacement immediately.

## 1.2 Feature

Four groups (history, statistics, alarms, and events) of embedded remote monitoring (RMON) agents for network monitoring and traffic analysis

- Provides SNMP protocol(v1/v2c/v3) to monitor and control the switch by using SNMP management applications such as HP Open View
- Supports IGMP snooping to limit flooding of IP multicast traffic and filtering for controlling the set of multicast groups to which hosts on a switch port can belong
- Supports 802.1d/1w/1s Spanning Tree Protocol for loop free installation.
- Supports 802.1Q VLAN for assigning users to VLAN associated with appropriate network resources, traffic patterns, and bandwidth. Up to 256 VLAN entries can be configured
- Supports Management VLAN for administration to protect switch to be attacked by client.

- Supports IEEE 802.3ad Link Aggregation, up to 14 LAG groups, and 8 ports for each LAG group
- Built-in DHCP client to get IP address from DHCP server automatically
- Supports SNTP to synchronize the precision time with Internet Time server.
- Supports many-to-one, one-to-one Port Mirroring function.
- Supports for IEEE 802.1p/DSCP CoS scheduling for classification and preferred high-priority traffic.
- Supports per port Ingress and Egress Rate Limiting.
- Supports Dynamic Learning mode for Port Security function, up to 24 MAC addresses can be learned for each port
- Supports 802.1X port-based authentication, and build-in RADIUS client to co-operate with the RADIUS servers.
- Supports broadcast, multicast, and unknown unicast storm control
- Supports Protected Port feature.
- Supports SSL/SSH secure access.
- Supports web-based interface for management
- Supports CLI interface for local console or remote Telnet management
- Supports TFTP, HTTP and X-modem protocol for firmware/configuration upgrade or backup.
- Supports TACACS+ login authentication.
- Supports DSCP remarking
- Supports DHCP Relay
- Supports IGMP Proxy
- Supports IGMP Querier
- Supports LLDP
- Supports IGMP Immediate Leave
- Supports RSTP Root Guard
- Supports DHCP/TFTP configuration download
- Supports Port Self-Loop Detection
- Supports DHCP Snooping
- Supports Dynamic ARP Inspection
- Supports IP Source Guard
- Supports Green Ethernet
- Supports Auto Dos

### 1.3 Hardware Specification

- Support 24 10/100Mbps copper ports with 2 shared mini-GBIC slots

- User configurable 100FX or 1000Base-SX/LX mini-GBIC fiber module on mini-GBIC ports
- Supports half duplex and full duplex modes and auto-negotiation for all 10BASE-T/100BASE-TX/1000BASE-T ports
- IEEE 802.3ab Auto MDI/MDI-X on all 100/1000 twisted-pair ports
- Automatic polarity detection and correction on all RJ-45 ports for automatic adjustment of wiring errors
- Throughput up to 48 Gbps.
- Provides IEEE802.3x Flow Control mechanism ensures zero packet loss, which uses Back Pressure for half-duplex operation and Flow Control for full duplex operation.
- Supports 8K MAC address and Up to 4Mb packet buffer
- Supports Store & Forward architecture and performs forwarding and filtering
- Provides non-blocking switching performance
- Supports Jumbo Frame up to 9KB
- Provides a RS-232 port for system configuration.
- Flexible TCAM-based Compact Field Process for packet classification and filtering.
- Low power consumption.

#### 1.4 Environments Specification

<b>Size (H x W x D)</b>	H 44 x W 430 x D 250mm
<b>Weight(Net/Gross)</b>	2.4kg / 3.5kg (88.2 oz / 123.5 oz)
<b>Power</b>	30W
<b>Operating Temp.</b>	0 °C ~ 40 °C (32 °F ~ 104 °F)
<b>Storage Temp.</b>	-20 °C ~ 70 °C (-4 °F ~ 158 °F)
<b>Operating Humidity</b>	20% to 85% relative humidity, Non-Condensing
<b>Storage Humidity</b>	10% to 90% relative humidity, Non-Condensing

#### 1.5 Standard Conformance

<b>EMC Certification</b>	FCC Class A, CE
--------------------------	-----------------

## 1.6 How to Use this Guide

This user guide is structured as follows:

**Chapter 2, *Installation*** explains the functions of the switch and how to physically install it.

**Chapter 3, *Configuration*** explains how to set up and modify the configuration of the switch.

**Chapter 4, *Specifications*** contains information about the cables, and the technical specifications of the switch.

Appendices include the Warranty Statement. Read them as necessary.



## 2. Installation

This chapter describes the function of the management switch components and shows how to install it on the desktop or shelf. Basic knowledge of networking is assumed. Read this chapter completely before continuing.

### 2.1 Product Description Overview

Micronet SP1658C supports 802.1Q VLAN, QoS, 802.1d / 1w / 1s Spanning Tree Protocol, 802.1x, Port Security, Port Mirroring, IGMP Snooping, STNP, Storm Control, Rate Control, SNMP etc. features.

### 2.2 Switch Overview

Figure 2.2.1a Front Panel



Figure 2.2.1b Rear Panel





Table 2.2.1c Port Function

	Port	Function
<b>Front panel</b>	1~24	This is where you connect the Cat. 5e or better ethernet cable for 10/100Mbps ethernet connection
	miniGBIC	This is where you connect the SFP module for fiber connection.
	Console	This is where you connect the RS-232 cable for CLI management.
<b>Real Panel</b>	Power	This is where you connect the AC power cord or DC adapter.

### 2.3 LED Function

This section explains the definition of the Switch's LEDs on the front panel.

POWER	 (Green)	Green lights when connected to AC power
LINK/ACT	 (Green)	Indicates a successful connection of a network. Otherwise, it indicates the link is off or no-link detected of that port. When the LED <b><i>blinks</i></b> , it indicates the port is activating and transmitting data

## 2.4 Reset Button

There is a Reset button on the front panel, which has two functionalities:

- a) To restore switch configuration to factory defaults  
Press the **Reset** button for more than 10 seconds, switch configuration will be restored to factory defaults and then reboots.
- b) To reboot switch  
Press the **Reset** button for less than 10 seconds, switch will reboot. Please note, you will lose unsaved change when doing this.



## 2.5 Installing the Switch

This section describes how to install and make connection to the SP1658C switch. The following diagrams shows the a typical network configuration, (**Figure 2.5.1**)

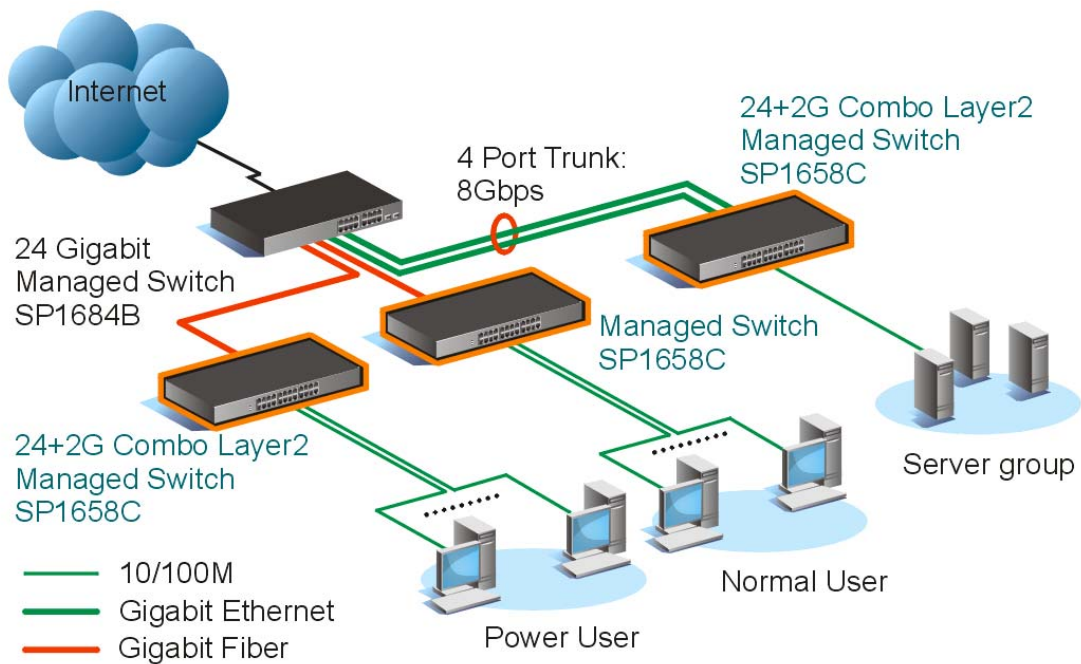
**Figure 2.5.1** Network Configuration for Layer 2 Management Switch



Read and perform the following procedures to install the switch,

	<p><b><u>Pre-Installation Considerations</u></b> <b>Gigabit Considerations:</b></p>	<p>If you will use the switch for Gigabit applications, keep in mind that the maximum UTP cabling length of Category 5e cable is 328 feet (100 meters).</p>
	<p><b><u>Positioning the switch:</u></b></p>	<p>When choosing a location for the switch, observe the following guidelines: Keep enough ventilation space between the switch and the surrounding objects.</p> <p>Keep cabling away from sources of electrical noise, power lines, and fluorescent lighting fixtures.</p> <p>Do not stack free-standing switch more than four units high.</p>

### Desktop or Shelf Mounting

To install the switch on a desktop or shelf, simply complete the following steps:

**Step 1** Place the switch on a desktop or shelf near an AC power source.

**Step 2** Keep enough ventilation space between the switch and the surrounding objects.



**Note:** When choosing a location, keep in mind the environmental restrictions discussed in Chapter 4, Specifications.

**Step 3** Connect the switch to network devices.

- A. Connect one end of a standard network cable to the RJ-45 ports on the front of the switch.
- B. Connect the other end of the cable to the network devices such as printer servers, workstations or routers.







**Note:** It is recommended to use the UTP Category 5e network cabling with RJ-45 tips for the network connection. For more information, please see the Cable Specifications in Chapter 4, Specifications.

**Step 4** Supply power to the switch.

- A. Connect one end of the power cable to the switch.
- B. Connect the power cube end of the power cable to a standard wall outlet.

## 2.6 Rack- Mount Placement

Before mounting the Switch, please read the following instructions carefully,

	<b>Elevated Operating Ambient</b>	If installed in a closed or multi-unit rack assembly, the operating ambient temperature of the rack environment may be greater than room ambient. Therefore, consideration should be given to installing the equipment in an environment compatible with the maximum ambient temperature (T <sub>ma</sub> ) specified by the manufacturer.
	<b>Reduced Air Flow</b>	Installation of the equipment in a rack should be such that the amount of air flow required for safe operation of the equipment is not compromised.
	<b>Mechanical Loading</b>	Mounting of the equipment in the rack should be such that a hazardous condition is not achieved due to uneven mechanical loading.
	<b>Circuit Overloading</b>	Consideration should be given to the connection of the equipment to the supply circuit and the effect that overloading of the circuits might have on overcurrent protection and supply wiring. Appropriate consideration of equipment nameplate ratings should be used when addressing this concern.
	<b>Reliable Earthing</b>	Reliable earthing of rack-mounted equipment should be maintained. Particular attention should be given to supply connections other than direct connections to the branch circuit (e.g. use of power strips)."

To mount the Switch in any standard-sized, 19-inch wide, 1U high rack, please follow these instructions:

Place the Switch on a hard flat surface with the front panel facing you. Attach a rack-mount bracket to one side of the Switch with the supplied screws. Then attach the other bracket to the other side. (**Figure 2.6.1**)

**Figure 2.6.1**

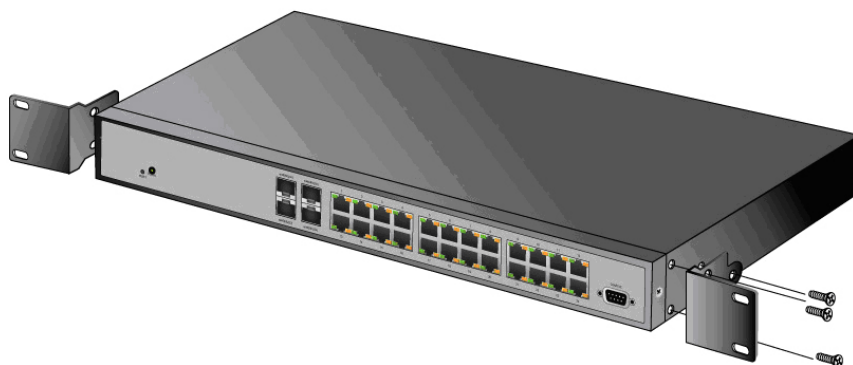

Make sure the brackets are properly attached to the Switch.  
Use the appropriate screws (not included) to securely attach the brackets to  
your rack. (**Figure 2.6.2**)

**Figure 2.6.2**

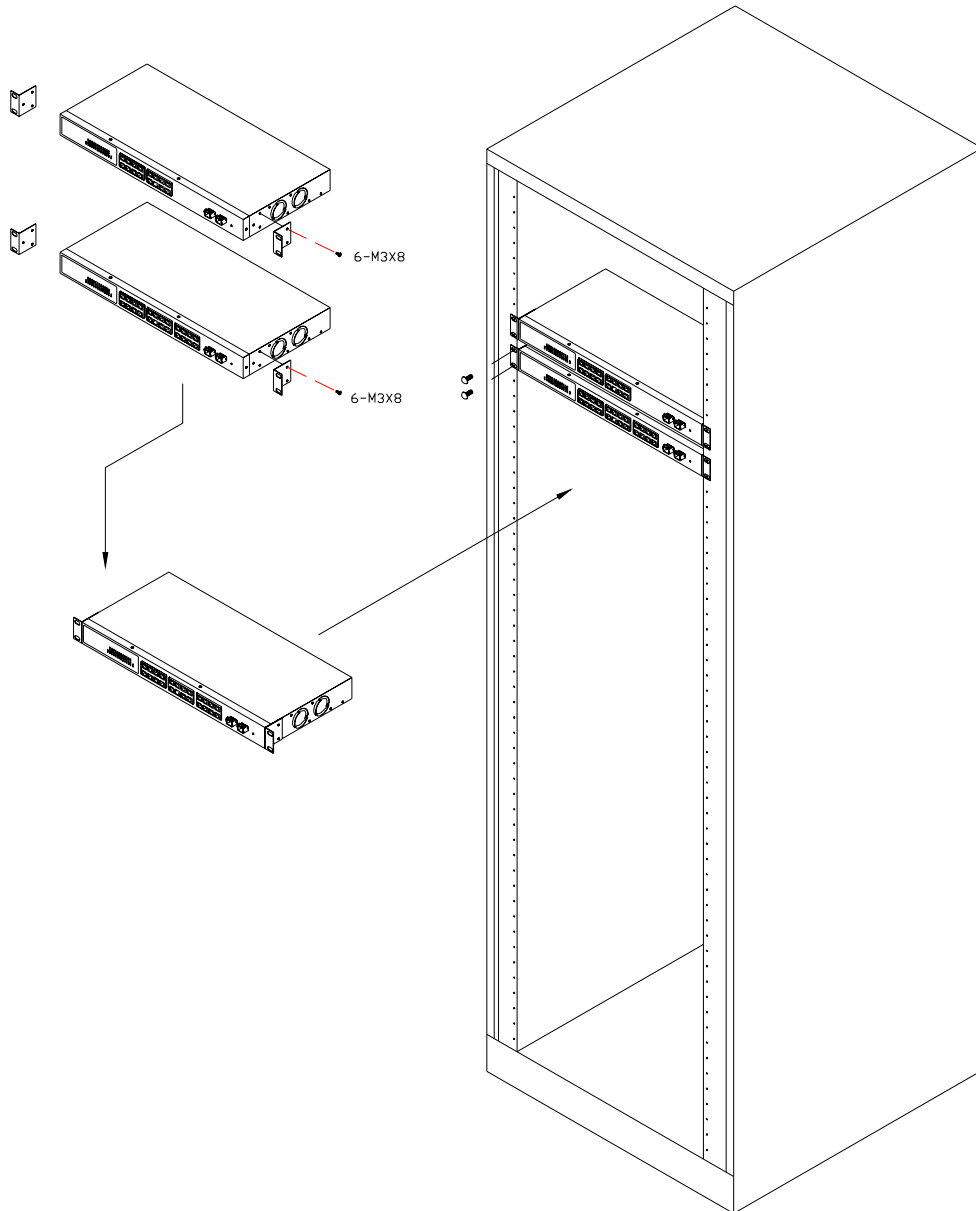

## 3. Configuration

The configuration programs are supplied with the SP1658C Switch. Unlike the unmanaged switch (dumb switch), the switch performs "management" functions that make the switch operate more effectively. This Chapter will describe the use of the switch Management Configuration program.

### Preparing for configuration

SP1658C Management Switch offers a console CLI interface for switch configuration and management. Users can use this interface to perform the activities such as configuring DHCP, ARP, assigning IP address and upgrading firmware etc.

There are four methods to manage your switch:

<b>Local Console Management</b>	You can manage the switch locally by connecting the switch to a PC or workstation with terminal emulation software using the serial port.
<b>Remote Console Management</b>	You can manage the switch by having a remote host establish a Telnet connection to the switch via an Ethernet or modem link.
<b>SNMP Management</b>	You can manage the switch across a LAN using a SNMP Network Management Station with a graphical user interface. Note that to use this management method, your network must use the IP protocol and your switch must be configured on the Network with a proper IP address. You may use any of the following method to manage the switch.
<b>Web-Browser</b>	You can manage the switch through a web connection by connecting to the switch's IP address using your web browser.

This User Guide provides instructions on how to configure the switch using the console interface. Read the following sections to start up:

<b>Connecting a PC or Terminal to the RS-232 Port</b>	When you are ready to configure the Management Function of the switch, make sure you have connected the supplied RS-232 serial cable to the RS-232 port at the front panel of your switch and your PC.
<b>Terminal Emulation Setup Program</b>	Run a terminal emulation program with the following setting. <ul style="list-style-type: none"> <li>• <b>Emulation:</b> VT-100 compatible</li> <li>• <b>Baud per second:</b> 38400</li> <li>• <b>Data bits:</b> 8</li> <li>• <b>Parity:</b> None</li> <li>• <b>Stop bits:</b> 1</li> <li>• <b>Flow Control:</b> None</li> </ul>
<b>Logging on to the switch</b>	Enter the factory default user name " <b>admin</b> " with no password when logging on to the switch. The password is set to be empty. If you can enter "?" on the command line screen, it will display all items so that you can configure by your requirements.

### 3.1 Web-based configuration

The Switch provides a Web-based interface for configuring and managing the Switch. This interface allows you to access the switch using the Web browser of your choice. This chapter describes how to use the switch's Web browser interface to configure and manage the switch.

#### Logging on the switch

To log on to the Switch:

**Step 1.** In your web browser, specify the IP address of the switch. Default IP address is **192.168.1.254**.

**Step 2.** Enter the factory default “admin” to login on the Switch with no password. Refer to the **figure 3-1**.

**Figure 3-1**





### 3-1-1. System Information

Device Name	N/A
Hardware Version	00.03.00
Boot Version	1.1.2
Firmware Version	1.20a
Build Date	Mon Dec 13 16:28:49 2010
MAC Address	00-11-3b-22-64-80
System Name	<input type="text"/>
System Location	<input type="text"/>
System Contact	<input type="text"/>

### 3-1-2. Network Management

IP configuration is one of the most important configurations in the switch. Without the proper setting, network manager will not be able to manage or view the device. The switch supports both manual IP address setting and automatic IP address setting via DHCP server. When IP address is changed, you must reboot the switch to have the setting taken effect and use the new IP to browse for web management and CLI management.

Function name:

Network Management

Function description:

Set IP address, subnet mask, default gateway and DNS for the switch.

IP Address Mode	Static <input type="button" value="v"/>
IP Address	<input type="text" value="192.168.1.254"/>
Subnet Mask	<input type="text" value="255.255.255.0"/>
Default Gateway	<input type="text" value="0.0.0.0"/>
Management VLAN	1 <input type="button" value="v"/>

### 3-1-3. Time Configuration

The switch provides manual and automatic ways to set the system time via NTP. Manual setting is simple and you just input "Year", "Month", "Day", "Hour", "Minute" and "Second" within the valid value range indicated in each item. If you input an invalid value, for example, 61 in minute, the switch will clamp the figure to 59.

Function name:

Time

Function description:

Set the system time by manual input or set it by syncing from Time servers.

The function also supports daylight saving for different area's time adjustment.

Enable Daylight Saving  
 (GMT) Greenwich Mean Time: Dublin, Edinburgh, Lisbon, London

Use SNTP Server  
 Server IP Address:  Update Time Now  
 Polling Interval: 1 day

Use Local Time  
 M D Y H M S  
 1 1 2007 9 49 8 Use Browser Time

Save Settings

### 3-2-1. Port Configuration

Port Configuration is applied to change the setting of each port. In this configuration function, you can set/reset the following functions.

Port	Link Status	Speed & Duplex	Flow Control
01	Down	--	--
02	Down	--	--
03	Down	--	--
04	Down	--	--
05	Down	--	--
06	Down	--	--
07	Down	--	--
08	Down	--	--
09	Down	--	--
10	Down	--	--
11	Down	--	--
12	Down	--	--
13	Down	--	--
14	Down	--	--
15	Down	--	--
16	Down	--	--
17	Up	100Mbps Full	Disabled

Port Number	Admin Mode	Auto Negotiation	Speed Duplex	Flow Control	LAG Group
01	Enable	Enable	100M Full	Disable	--

Save Settings

### 3-2-2. LACP property

The Port Trunking Configuration is used to configure the settings of Link Aggregation. You can bundle more than one port with the same speed, full duplex and the same MAC to be a single logical port, thus the logical port aggregates the bandwidth of these ports. This means you can apply your current Ethernet equipments to build the bandwidth aggregation. For example, if there are three Fast Ethernet ports aggregated in a logical port, then this logical port has bandwidth three times as high as a single Fast Ethernet port has.

The switch supports two kinds of port trunking methods:

LACP:

Ports using Link Aggregation Control Protocol (according to IEEE 802.3ad

specification) as their trunking method can choose their unique LACP GroupID (1~8) to form a logic “trunked port”. The benefit of using LACP is that a port makes an agreement with its peer port before it becomes a ready member of a “trunk group” (also called aggregator). LACP is safer than the other trunking method - static trunk.

The switch LACP does not support the followings:

- Link Aggregation across switches
- Aggregation with non-IEEE 802.3 MAC link
- Operating in half-duplex mode
- Aggregate the ports with different data rates

Static Trunk:

Ports using Static Trunk as their trunk method can choose their unique Static GroupID (also 1~8, this Static groupID can be the same with another LACP groupID) to form a logic “trunked port”. The benefit of using Static Trunk method is that a port can immediately become a member of a trunk group without any handshaking with its peer port. This is also a disadvantage because the peer ports of your static trunk group may not know that they should be aggregate together to form a “logic trunked port”. Using Static Trunk on both end of a link is strongly recommended. Please also note that low speed links will stay in “not ready” state when using static trunk to aggregate with high speed links.

As to system restrictions about the port aggregation function on the switch, In the management point of view, the switch supports maximum 8 trunk groups for LACP and additional 8 trunk groups for Static Trunk. But in the system capability view, only 8 “real trunked” groups are supported. An LACP trunk group with more than one ready member-ports is a “real trunked” group. An LACP trunk group with only one or less than one ready member-ports is not a “real trunked” group. Any Static trunk group is a “real trunked” group.

LACP System Priority  (0 - 65535)

Port Number	Priority	Admin Key	LAG Group	Status
<a href="#">01</a>	1001	1000	N/A	
<a href="#">02</a>	1002	1000	N/A	
<a href="#">03</a>	1003	1000	N/A	
<a href="#">04</a>	1004	1000	N/A	
<a href="#">05</a>	1005	1000	N/A	
<a href="#">06</a>	1006	1000	N/A	
<a href="#">07</a>	1007	1000	N/A	
<a href="#">08</a>	1008	1000	N/A	
<a href="#">09</a>	1009	1000	N/A	
<a href="#">10</a>	1010	1000	N/A	
<a href="#">11</a>	1011	1000	N/A	
<a href="#">12</a>	1012	1000	N/A	

# LACP Properties for Port 01

Admin Key

LACP Port Priority

## 3-2-3. LAG Group

LAG Group	Port Member	Link Status	Speed Duplex
<a href="#">01</a>	N/A	Down	--
<a href="#">02</a>	N/A	Down	--
<a href="#">03</a>	N/A	Down	--

**LAG LAG01**

<b>01</b>	<b>02</b>	<b>03</b>	<b>04</b>	<b>05</b>	<b>06</b>	<b>07</b>	<b>08</b>	<b>09</b>	<b>10</b>	<b>11</b>	<b>12</b>
<input type="checkbox"/>	<input type="checkbox"/>	<input type="checkbox"/>	<input type="checkbox"/>	<input type="checkbox"/>	<input type="checkbox"/>	<input type="checkbox"/>	<input type="checkbox"/>	<input type="checkbox"/>	<input type="checkbox"/>	<input type="checkbox"/>	<input type="checkbox"/>
<b>13</b>	<b>14</b>	<b>15</b>	<b>16</b>	<b>17</b>	<b>18</b>	<b>19</b>	<b>20</b>	<b>21</b>	<b>22</b>	<b>23</b>	<b>24</b>
<input type="checkbox"/>	<input type="checkbox"/>	<input type="checkbox"/>	<input type="checkbox"/>	<input type="checkbox"/>	<input type="checkbox"/>	<input type="checkbox"/>	<input type="checkbox"/>	<input type="checkbox"/>	<input type="checkbox"/>	<input type="checkbox"/>	<input type="checkbox"/>
<b>G1</b>	<b>G2</b>										
<input type="checkbox"/>	<input type="checkbox"/>										

### 3-3-1. Create VLAN

The Create VLAN screen provides information and global parameters for configuring and working with VLANs

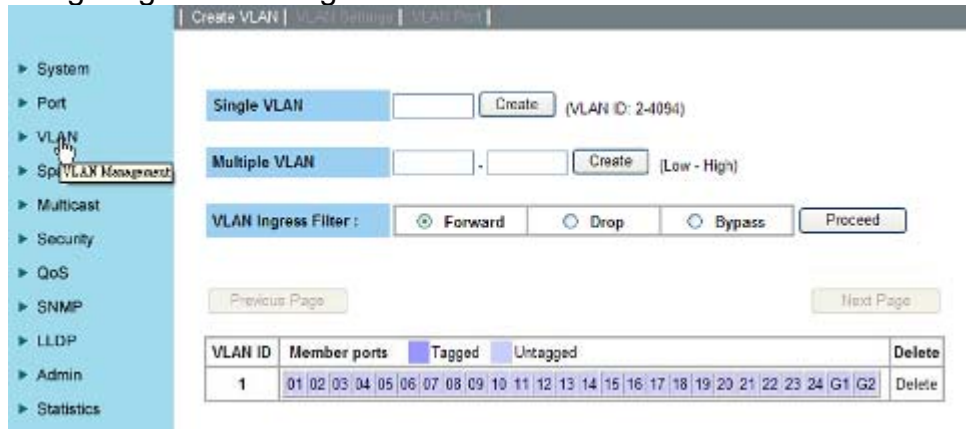

### 3-3-2. VLAN Settings

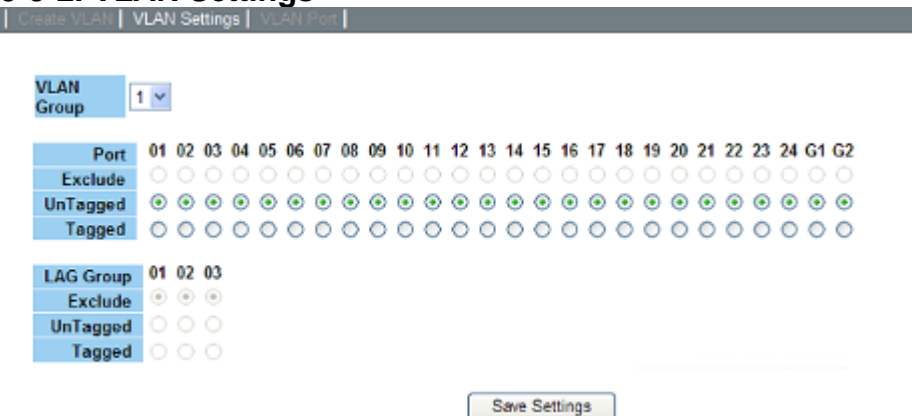

### 3-3-3. VLAN Port



Port Number	PVID	Protected Port	Drop Non 1Q Frame
01	1	<input type="checkbox"/>	<input type="checkbox"/>
02	1	<input type="checkbox"/>	<input type="checkbox"/>
03	1	<input type="checkbox"/>	<input type="checkbox"/>
04	1	<input type="checkbox"/>	<input type="checkbox"/>
05	1	<input type="checkbox"/>	<input type="checkbox"/>
06	1	<input type="checkbox"/>	<input type="checkbox"/>
07	1	<input type="checkbox"/>	<input type="checkbox"/>
08	1	<input type="checkbox"/>	<input type="checkbox"/>
09	1	<input type="checkbox"/>	<input type="checkbox"/>
10	1	<input type="checkbox"/>	<input type="checkbox"/>
11	1	<input type="checkbox"/>	<input type="checkbox"/>
12	1	<input type="checkbox"/>	<input type="checkbox"/>

### 3-4-1. RSTP

The Rapid Spanning Tree Protocol (RSTP) provides rapid convergence of the spanning tree by assigning port roles and by determining the active topology. The RSTP builds upon the IEEE802.1D STP protocol to select the switch with the highest switch priority as the root switch.

RSTP | RSTP Port | MSTP | MSTP Port | MSTP Instance | MSTP Interface

- ▶ System
- ▶ Port
- ▶ VLAN
- ▶ Spanning Tree
- ▶ Multicast
- ▶ Security
- ▶ QoS
- ▶ SNMP

Enable RSTP

Property	Bridge Setting	Root Status
Priority (0 - 61440)	32768	32768
Max Age (6-40 sec)	20	20
Forward Delay (4-30 sec)	15	15
Designated Root Bridge		-----

Save Settings

### 3-4-2. RSTP

RSTP | RSTP Port | MSTP | MSTP Port | MSTP Instance | MSTP Interface

Port	Participate	Cost	Priority	Edge	P2P	Status	Role
01	<input type="checkbox"/> Yes	-	-	-	-	-	-
02	<input type="checkbox"/> Yes	-	-	-	-	-	-
03	<input type="checkbox"/> Yes	-	-	-	-	-	-
04	<input type="checkbox"/> Yes	-	-	-	-	-	-
05	<input type="checkbox"/> Yes	-	-	-	-	-	-
06	<input type="checkbox"/> Yes	-	-	-	-	-	-
07	<input type="checkbox"/> Yes	-	-	-	-	-	-
08	<input type="checkbox"/> Yes	-	-	-	-	-	-
09	<input type="checkbox"/> Yes	-	-	-	-	-	-
10	<input type="checkbox"/> Yes	-	-	-	-	-	-
11	<input type="checkbox"/> Yes	-	-	-	-	-	-

### 3-4-3. MSTP

RSTP | RSTP Port | MSTP | MSTP Port | MSTP Instance | MSTP Interface

Enable MSTP

Region Name (Max. 32 chars.)

Revision Level (0-65535)

Max Age (6-40 sec)

Forward Delay (4-30 sec)

Max Hops (1-40)

Save Settings

### 3-4-4. MSTP Port

#### MSTP Port Settings

#### [MSTP Port Priority & Path Cost Settings](#)

Port	Edge	P2P	Migration Check
01	-	-	-
02	-	-	-
03	-	-	-
04	-	-	-
05	-	-	-
06	-	-	-
07	-	-	-
08	-	-	-
09	-	-	-
10	-	-	-
11	-	-	-
12	-	-	-
13	-	-	-
14	-	-	-
15	-	-	-

### 3-4-5. MSTP Instance

MST Instance    
 MST ID (0-4094)    
 VLAN Range

MST Instance	MST ID	VLAN Members
0	0	

Instance	Bridge Priority
0	---

### 3-4-6. MSTP Interface

Instance

Port	Path Cost	Priority	Edge	P2P	Port Status	Port Role
01	-	-	-	-	-	-
02	-	-	-	-	-	-
03	-	-	-	-	-	-
04	-	-	-	-	-	-
05	-	-	-	-	-	-
06	-	-	-	-	-	-
07	-	-	-	-	-	-
08	-	-	-	-	-	-
09	-	-	-	-	-	-
10	-	-	-	-	-	-
11	-	-	-	-	-	-
12	-	-	-	-	-	-
13	-	-	-	-	-	-
14	-	-	-	-	-	-
15	-	-	-	-	-	-

### 3-5-1. Static Multicast

Static multicast groups provides a way to add and delete multicast addresses in the L2 address table.

Static Multicast | Static Multicast Table | IGMP

Group Name	<input type="text"/>	(Max. 8 characters)
VLAN ID	<input type="text"/>	(1 ~ 4094)
MAC Address	<input type="text"/>	(01:xx:xx:xx:xx:xx)

Port 01 02 03 04 05 06 07 08 09 10 11 12 13 14 15 16 17 18 19 20 21 22 23 24 G1 G2

Create..

### 3-5-2. Static Multicast Table

Static Multicast | Static Multicast Table | IGMP

The Maximum Number of Multicast Groups is 128

Group ID	Group Name	VLAN ID	Multicast Address	Member Port	Modify	Delete
----------	------------	---------	-------------------	-------------	--------	--------

Save Settings

### 3-5-3. IGMP

Static Multicast | Static Multicast Table | IGMP

Enable IGMP Snooping  
 Enable IGMP Proxy  
 Enable IGMP Querier

Assign Router Ports:

1 2 3 4 5 6 7 8 9 10 11 12 13 14 15 16 17 18 19 20 21 22 23 24 G1 G2

Save Settings Group Membership Dynamic Router Port



### 3-6-1. Port Security

Port Security provides two kinds of security modes, Static and Dynamic, to limit user's access on all ports.

Port Security | 802.1X | RADIUS | Storm Control | Management IP List

- System
- Port
- VLAN
- Spanning Tree
- Multicast
- Security
- QoS
- SNMP

Port: All  
Security Mode: None  
Max Entries: 0

Save Settings Show Security Tbl

Item	Source MAC	Port	Delete
Add Security MAC			
Previous Page			
Next Page			

### 3-6-2. 802.1x

Port Security | 802.1X | RADIUS | Storm Control | Management IP List

Enable 802.1X

Save Settings

### 3-6-3. RADIUS

Port Security | 802.1X | RADIUS | Storm Control | Management IP List

RADIUS Server IP Address: 0 . 0 . 0 . 0  
Authorization Port: 1812  
Secret Key String:

Save Settings

### 3-6-4. Storm Control

Port Security | 802.1X | RADIUS | Storm Control | Management IP List

Port: All  
Control Type: None  
Control Rate: No Limit

Save Settings Show Control Table

### 3-6-5. Management IP List

Management	Disabled ▾
IP Address 1	<input type="text"/>
IP Address 2	<input type="text"/>
IP Address 3	<input type="text"/>
IP Address 4	<input type="text"/>
IP Address 5	<input type="text"/>
IP Address 6	<input type="text"/>
IP Address 7	<input type="text"/>
IP Address 8	<input type="text"/>

Save Settings

### 3-7-1. QUEUE Settings

#### Scheduling Mode

Selects Strict Priority, the packets in the higher queue will always be served first until the queue is empty. Select Weighted Round Robin, the packets will be served according to the queue weight.

#### Queue

Indicates priority queues. Queue 1 is the lowest priority queue, and Queue 4 is the highest priority queue.

#### Weight

Indicates the weight (number of packets) to be served in the queue before moving to serve next queue. A high priority queue should have a higher weight than a low priority queue.

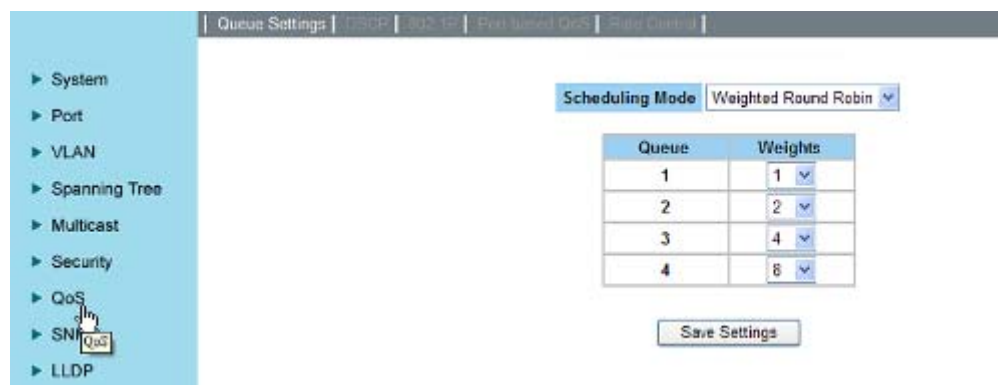

### 3-7-2. DSCP



### 3-7-3. 802.1P

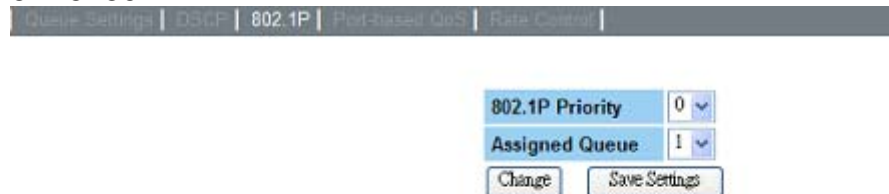

Priority	Queue
0	1
1	1
2	2
3	2
4	3
5	3
6	4
7	4

### 3-7-4. Port based QoS

High Priority											
01	02	03	04	05	06	07	08	09	10	11	12
<input type="checkbox"/>	<input type="checkbox"/>	<input type="checkbox"/>	<input type="checkbox"/>	<input type="checkbox"/>	<input type="checkbox"/>	<input type="checkbox"/>	<input type="checkbox"/>	<input type="checkbox"/>	<input type="checkbox"/>	<input type="checkbox"/>	<input type="checkbox"/>
13	14	15	16	17	18	19	20	21	22	23	24
<input type="checkbox"/>	<input type="checkbox"/>	<input type="checkbox"/>	<input type="checkbox"/>	<input type="checkbox"/>	<input type="checkbox"/>	<input type="checkbox"/>	<input type="checkbox"/>	<input type="checkbox"/>	<input type="checkbox"/>	<input type="checkbox"/>	<input type="checkbox"/>
G1	G2										
<input type="checkbox"/>	<input type="checkbox"/>										

### 3-7-5. Rate Control

Port

Ingress Rate

Egress Rate

### 3-8-1. SNMP

Enable SNMP Functionalities

Enables or Disables SNMP function on this device.

Enable SNMP Notification

Enables or Disables SNMP notification function on this device.

Engine ID

Configures the Engine ID on this device.

SNMP | Group Profile | User Profile | Community Profile | SNMP Trap Station

- System
- Port
- VLAN
- Spanning Tree
- Multicast
- Security
- QoS
- SNMP
- LLDP

Enable SNMP Functionalities

Enable SNMP Notification

<input type="radio"/>	Engine ID:	80 00 07 e5 04
<input checked="" type="radio"/>	Use Default:	80 00 07 e5 04 00036d226480

Save Settings

### 3-8-2. Group Profile

SNMP | Group Profile | User Profile | Community Profile | SNMP Trap Station

Group ID

Group ID	Group Name	SNMP Version	Authentication	Access
----------	------------	--------------	----------------	--------

Previous Page Next Page

### 3-8-3. User Profile

SNMP | Group Profile | User Profile | Community Profile | SNMP Trap Station

User ID

User ID	User Name	Group Name	SNMP Version	Auth Type
---------	-----------	------------	--------------	-----------

Previous Page Next Page

### 3-8-4. Community Profile

SNMP | Group Profile | User Profile | Community Profile | SNMP Trap Station

Community ID

Community ID	Community String	Group Name	Remote Station IP
--------------	------------------	------------	-------------------

Previous Page Next Page

### 3-8-5. SNMP Trap Station

SNMP | Group Profile | User Profile | Community Profile | SNMP Trap Station

Trap Station ID

Trap Station ID	Community String	Remote IP Address	Link Change Trap	Boot Up Trap	Version
-----------------	------------------	-------------------	------------------	--------------	---------

Previous Page Next Page

### 3-9-1. LLDP

#### Advertised Interval

The interval at which LLDP frames are transmitted on behalf of this LLDP agent.

#### Hold value

A multiplier to Advertised interval. The result would be the TTL value for the information advertised.

#### Transmit Delay

The delay between successive LLDP frame transmissions initiated by value/status changes in the local system

#### Re-initialization delay

The minimum delay period before from the time a ports becomes disabled until re-initialization.

#### Notification Interval

The interval at which notification are generated when remote MSAP information changes.

#### Management Address Transmit Ports

Indicates the ports on which the management address will be transmitted.

#### Port Configuration

LLDP configuration for a port.

LLDP System Settings [Change Settings](#)

LLDP:	Disabled
Advertised Interval (5-32768 sec):	30
Hold value (2-10):	4
Re-initialization Delay (1-10 sec):	2
Transmit Delay (1-8192 sec):	2
Notification Interval (5-3600 sec):	5
MED Device Type:	Not Defined
Fast Start Count(1-10):	3
Management Address Transmit Ports:	

LLDP Port Settings [Change Settings](#)

Select	Port	LLDP State	SNMP Notification	MED Fast Start Notification	Optional Enabled TLVs			
					Basic	802.1	802.3	MED
<input type="radio"/>	1	Disabled	Disabled	Disabled	--	--	--	--
<input type="radio"/>	2	Disabled	Disabled	Disabled	--	--	--	--
<input type="radio"/>	3	Disabled	Disabled	Disabled	--	--	--	--
<input type="radio"/>	4	Disabled	Disabled	Disabled	--	--	--	--
<input type="radio"/>	5	Disabled	Disabled	Disabled	--	--	--	--
<input type="radio"/>	6	Disabled	Disabled	Disabled	--	--	--	--
<input type="radio"/>	7	Disabled	Disabled	Disabled	--	--	--	--
<input type="radio"/>	8	Disabled	Disabled	Disabled	--	--	--	--
<input type="radio"/>	9	Disabled	Disabled	Disabled	--	--	--	--
<input type="radio"/>	10	Disabled	Disabled	Disabled	--	--	--	--
<input type="radio"/>	11	Disabled	Disabled	Disabled	--	--	--	--

### 3-9-2. LLDP Statistics

Number of Inserts:	N/A
Number of Deletes:	N/A
Number of Drops:	N/A
Number of Ageouts:	N/A

Port	Tx Frames	Rx Frames Discarded	Rx Frames Errors	Rx Frames Total	Rx Frames TLVs Discarded	Rx Frames TLVs Unrecognized	Rx Frames Ageouts
1	N/A	N/A	N/A	N/A	N/A	N/A	N/A
2	N/A	N/A	N/A	N/A	N/A	N/A	N/A
3	N/A	N/A	N/A	N/A	N/A	N/A	N/A
4	N/A	N/A	N/A	N/A	N/A	N/A	N/A
5	N/A	N/A	N/A	N/A	N/A	N/A	N/A
6	N/A	N/A	N/A	N/A	N/A	N/A	N/A
7	N/A	N/A	N/A	N/A	N/A	N/A	N/A
8	N/A	N/A	N/A	N/A	N/A	N/A	N/A

### 3-9-3. LLDP Information

<b>Chassis ID SubType</b>					N/A
<b>Chassis ID</b>					N/A
<b>System Name</b>					N/A
<b>System Description</b>					N/A
<b>System Capabilities</b>					N/A
<b>Enabled Capabilities</b>					N/A
<b>MED Device Type</b>					N/A
<b>Management Addresses</b>					
<b>Address Sub-type</b>	<b>Address</b>	<b>Interface Sub-type</b>	<b>Interface Number</b>	<b>OID</b>	
N/A	N/A	N/A	N/A	N/A	N/A

Port	Port ID SubType	Port ID	Port Description
1	N/A	N/A	N/A
2	N/A	N/A	N/A
3	N/A	N/A	N/A
4	N/A	N/A	N/A
5	N/A	N/A	N/A
6	N/A	N/A	N/A
7	N/A	N/A	N/A
8	N/A	N/A	N/A
9	N/A	N/A	N/A
10	N/A	N/A	N/A
11	N/A	N/A	N/A
12	N/A	N/A	N/A
13	N/A	N/A	N/A
14	N/A	N/A	N/A
15	N/A	N/A	N/A

### 3-9-4. Remote Information

LLDP Settings | LLDP Statistics | Local Information | Remote Information |

MSAP Entry	Local Port	Chassis ID SubType	Chassis ID	Port ID SubType	Port ID	Details
------------	------------	--------------------	------------	-----------------	---------	---------



### 3-10-1. Admin

#### Admin Password

The screen allows user to change the password of the administrator.

#### Old Password

Enters original password.

#### New Password

Enters a desired password to replace the original one.

#### Confirm New Password

Enters new password again for confirmation.

Admin Password | L2 Table | Static Address | Port Mapping | Admin Timeout | Firmware Upgrade | >>

System  
Port  
VLAN  
Spanning Tree  
Multicast  
Security  
QoS  
SNMP  
LLDP  
Admin  
Static Address  
Help

Old Password  
New Password  
Confirm New Password

Save Settings

### 3-10-2. L2 Table

Admin Password | L2 Table | Static Address | Port Mapping | Admin Timeout | Firmware Upgrade | >>

L2 Table Aging Enable

Aging Time 300

Save Settings

Reload L2 Table Clear L2 Table

Entry	Source MAC	Port	VLAN ID	Type
0	00-16-D3-3A-E7-86	17	1	dynamic
1	00-E0-0F-21-15-20	24	1	dynamic
2	00-11-3B-15-3A-D8	24	1	dynamic
3	00-09-A3-00-DD-CD	24	1	dynamic

Total L2 Entries: 4 ( Static: 0 , Dynamic: 4 )

Previous Page Next Page

L2 Entry Lookup:

MAC 00-00-00-00-00-00 VLAN ID 1 Lookup

### 3-10-3. Static Address

Admin Password | L2 Table | Static Address | Port Mapping | Admin Timeout | Firmware Upgrade | >>

Static Address: [ADD](#)

Entry	Source MAC	Port	VLAN ID	Delete
-------	------------	------	---------	--------

### 3-10-4. Port Mirroring

Admin Password | L2 Table | Static Address | Port Mirroring | Admin Timeout | Firmware Upgrade | >>

Function

[Previous](#) ... [Next](#)

Port ID	01	02	03	04	05	06	07	08	09	10	11	12	13
Ingress Mirror	<input type="checkbox"/>	<input type="checkbox"/>	<input type="checkbox"/>	<input type="checkbox"/>	<input type="checkbox"/>	<input type="checkbox"/>	<input type="checkbox"/>	<input type="checkbox"/>	<input type="checkbox"/>	<input type="checkbox"/>	<input type="checkbox"/>	<input type="checkbox"/>	<input type="checkbox"/>
Egress Mirror	<input type="checkbox"/>	<input type="checkbox"/>	<input type="checkbox"/>	<input type="checkbox"/>	<input type="checkbox"/>	<input type="checkbox"/>	<input type="checkbox"/>	<input type="checkbox"/>	<input type="checkbox"/>	<input type="checkbox"/>	<input type="checkbox"/>	<input type="checkbox"/>	<input type="checkbox"/>
Mirror To	<input type="radio"/>	<input type="radio"/>	<input type="radio"/>	<input type="radio"/>	<input type="radio"/>	<input type="radio"/>	<input type="radio"/>	<input type="radio"/>	<input type="radio"/>	<input type="radio"/>	<input type="radio"/>	<input type="radio"/>	<input type="radio"/>

### 3-10-5. Admin Timeout

Admin Password | L2 Table | Static Address | Port Mirroring | Admin Timeout | Firmware Upgrade | >>

Enable Web/Console Admin Timeout

Timeout Value (Seconds)

### 3-10-6. Firmware Upgrade

Admin Password | L2 Table | Static Address | Port Mirroring | Admin Timeout | Firmware Upgrade | >>

Protocol

Action  Upgrade  BACKUP

Source File

### 3-10-7. Reboot

<< | Reboot | Save Configurations | Logs Settings | Log Server | Memory Logs | Flash Logs | >>

Reboot Switch

Restore Configuration to Factory Defaults (Keep Switch IP address)

Restore Configuration to Factory Defaults

### 3-10-8. Save Configurations

<< | Reboot | Save Configurations | Logs Settings | Log Server | Memory Logs | Flash Logs | >>

Protocol

Action  Upgrade  Backup

Source File

### 3-10-9. Logs Settings

[Reboot](#) | [Save Configurations](#) | [Logs Settings](#) | [Log Server](#) | [Memory Logs](#) | [Flash Logs](#) | [»](#)

Target \ Level	ERROR	WARNING	INFO	DEBUG	ACTION
<a href="#">Memory</a>	<input checked="" type="checkbox"/>	<input checked="" type="checkbox"/>	<input checked="" type="checkbox"/>	<input type="checkbox"/>	<a href="#">CLEAR</a>
<a href="#">Flash</a>	<input checked="" type="checkbox"/>	<input checked="" type="checkbox"/>	<input type="checkbox"/>	<input type="checkbox"/>	<a href="#">CLEAR</a>
<a href="#">Console</a>	<input checked="" type="checkbox"/>	<input checked="" type="checkbox"/>	<input type="checkbox"/>	<input type="checkbox"/>	

### 3-10-10. Log Server

[Save Configurations](#) | [Logs Settings](#) | [Log Server](#) | [Memory Logs](#) | [Flash Logs](#) | [»](#)

**Server Name**   
**Server IP Address**   
**Service UDP Port**   
**Facility**

### 3-10-11. Memort Logs

[«](#) | [Reboot](#) | [Save Configurations](#) | [Logs Settings](#) | [Log Server](#) | [Memory Logs](#) | [Flash Logs](#) | [»](#)

Page 1 of 1

Index	Level	Category	Time	Message
49	INFO	WEB	2007/ 1/ 1 9:44:02	User admin logged from 192.168.1.114
48	INFO	WEB	2007/ 1/ 1 9:09:44	User session from 192.168.1.114 has expired.
47	INFO	WEB	2007/ 1/ 1 9:04:31	User admin logged from 192.168.1.114
46	INFO	PORT	2007/ 1/ 1 9:01:46	Link change UP, port 24, 100Mb Full Duplex.
45	INFO	WEB	2007/ 1/ 1 8:22:18	User session from 192.168.1.60 has expired.
44	INFO	WEB	2007/ 1/ 1 8:15:18	User admin logged from 192.168.1.60
43	INFO	PORT	2007/ 1/ 1 8:14:56	Link change UP, port 17, 100Mb Full Duplex.
42	INFO	PORT	2007/ 1/ 1 6:40:41	Link change DOWN, port 17.
41	INFO	PORT	2007/ 1/ 1 4:35:52	Link change DOWN, port 24.
40	INFO	WEB	2007/ 1/ 1 1:49:32	User session from 192.168.1.60 has expired.
39	INFO	WEB	2007/ 1/ 1 1:44:24	User admin logged from 192.168.1.60
38	INFO	WEB	2007/ 1/ 1 0:54:06	User session from 192.168.1.60 has expired.

### 3-10-12. Flash Logs

[«](#) | [Reboot](#) | [Save Configurations](#) | [Logs Settings](#) | [Log Server](#) | [Memory Logs](#) | [Flash Logs](#) | [»](#)

Page 1 of 1

Index	Level	Category	Time	Message
-------	-------	----------	------	---------

### 3-10-13. Ping Function

← | Ping Function | Cable Diagnostic | DHCP Relay | DHCP Option 82 |

Host IP Address  .  .  .

### 3-10-14. Cable Diagnostic

← | Ping Function | Cable Diagnostic | DHCP Relay | DHCP Option 82 |

Port  ▼

### 3-10-15. DHCP Relay

← | Ping Function | Cable Diagnostic | DHCP Relay | DHCP Option 82 |

Mode  ▼

Server IP

### 3-10-16. DHCP Option 82

← | Ping Function | Cable Diagnostic | DHCP Relay | DHCP Option 82 |

Select VLAN Interface

1	
---	--

### 3-11-1. Statistics-802.1x Statistic

#### Port

Indicates the port number.

#### Octets Recieved

The number of octets received on this port during the session.

#### Octets Transmitted

The number of octets transmitted on this port during the session.

#### Session Time

The duration of the session in seconds.

#### Termination Cause

The reason for the session termination. This parameter can take the following values,

- 1) Supplicant Logoff (1)
- 2) Port Failure (2)
- 3) Supplicant Restart (3)
- 4) Reauthentication Failure (4)
- 5) AuthControlledPortControl set to ForceUnauthorized (5)
- 6) Port re-initialization (6)
- 7) Port Administratively Disabled (7)
- 8) Not Terminated Yet (999)

802.1X Statistic   RMON Statistic   RMON Event   RMON Event Log   RMON Alarm   RMON History						
Port	Octet Received	Octet Transmitted	Session Time	Terminate Cause	User Name	
01	0	0	0	0	N/A	
02	0	0	0	0	N/A	
03	0	0	0	0	N/A	
04	0	0	0	0	N/A	
05	0	0	0	0	N/A	
06	0	0	0	0	N/A	
07	0	0	0	0	N/A	
08	0	0	0	0	N/A	
09	0	0	0	0	N/A	
10	0	0	0	0	N/A	
11	0	0	0	0	N/A	
12	0	0	0	0	N/A	
13	0	0	0	0	N/A	
14	0	0	0	0	N/A	
15	0	0	0	0	N/A	
16	0	0	0	0	N/A	

### 3-11-2. RMON Statistic

802.1X Statistic   RMON Statistic   RMON Event   RMON Event Log   RMON Alarm   RMON History		
Source Interface	Owner	Status
<a href="#">01</a>	monitor	Disabled
<a href="#">02</a>	monitor	Disabled
<a href="#">03</a>	monitor	Disabled
<a href="#">04</a>	monitor	Disabled
<a href="#">05</a>	monitor	Disabled
<a href="#">06</a>	monitor	Disabled
<a href="#">07</a>	monitor	Disabled
<a href="#">08</a>	monitor	Disabled
<a href="#">09</a>	monitor	Disabled
<a href="#">10</a>	monitor	Disabled
<a href="#">11</a>	monitor	Disabled
<a href="#">12</a>	monitor	Disabled
<a href="#">13</a>	monitor	Disabled
<a href="#">14</a>	monitor	Disabled
<a href="#">15</a>	monitor	Disabled

### 3-11-3. RMON Event

<b>Index</b>	1
<b>Description</b>	<input type="text"/>
<b>Event Type</b>	<input checked="" type="radio"/> None <input type="radio"/> Log <input type="radio"/> SNMP-Trap <input type="radio"/> Log and Trap
<b>Community</b>	<input type="text"/>
<b>Owner</b>	<input type="text"/>

### 3-11-4. RMON Event log

Index	Event Type	Last Time Sent	Owner
-------	------------	----------------	-------

### 3-11-5. RMON Alarm

<b>Index</b>	1
<b>Interval(Second)</b>	<input type="text" value="0"/>
<b>Source Interface</b>	(Unassigned) ▾
<b>Variable</b>	(Unassigned) ▾
<b>Sample Type</b>	Absolute ▾
<b>Startup Alarm</b>	Rising Threshold ▾
<b>Rising Threshold</b>	<input type="text" value="0"/>
<b>Falling Threshold</b>	<input type="text" value="0"/>
<b>Rising Event</b>	0:None(Unassigned) ▾
<b>Falling Event</b>	0:None(Unassigned) ▾
<b>Owner</b>	<input type="text"/>

### 3-11-6. RMON History

Control Index

Index	Source Interface	Sampling Requested	Current Number of Samples	Sampling Interval	Owner	Status
<a href="#">1</a>	01	50	50	1800	monitor	Disabled
<a href="#">2</a>	02	50	50	1800	monitor	Disabled
<a href="#">3</a>	03	50	50	1800	monitor	Disabled
<a href="#">4</a>	04	50	50	1800	monitor	Disabled
<a href="#">5</a>	05	50	50	1800	monitor	Disabled
<a href="#">6</a>	06	50	50	1800	monitor	Disabled
<a href="#">7</a>	07	50	50	1800	monitor	Disabled
<a href="#">8</a>	08	50	50	1800	monitor	Disabled
<a href="#">9</a>	09	50	50	1800	monitor	Disabled
<a href="#">10</a>	10	50	50	1800	monitor	Disabled
<a href="#">11</a>	11	50	50	1800	monitor	Disabled
<a href="#">12</a>	12	50	50	1800	monitor	Disabled
<a href="#">13</a>	13	50	50	1800	monitor	Disabled
<a href="#">14</a>	14	50	50	1800	monitor	Disabled

### 3-12-1. Help

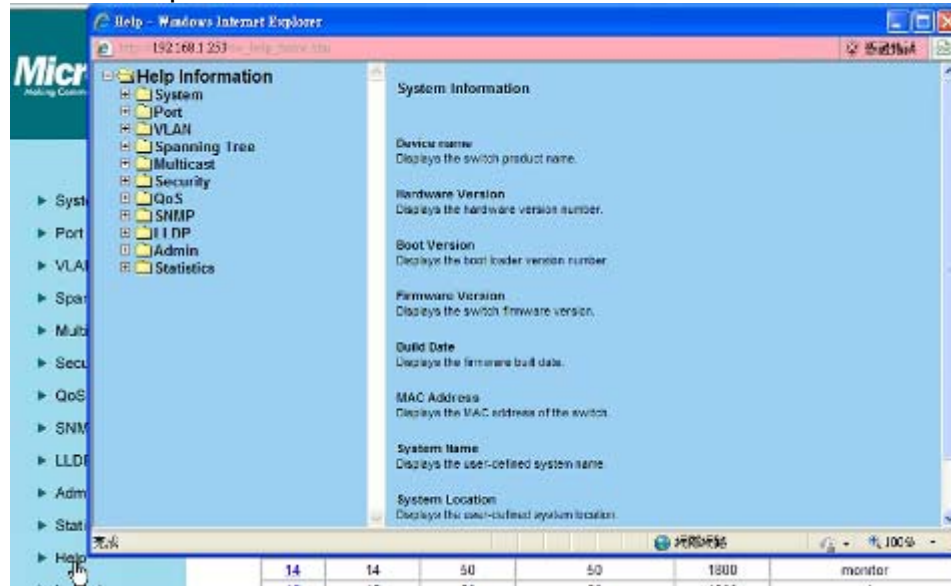



### 3-13-1. Log out



## 3.2 Command Line Interface (by Console or Telnet)

### Mode-based Command Hierarchy

The Command Line Interface (CLI) groups all the commands in appropriate modes by the nature of the commands. Examples of the CLI command modes are described below. Each of the command modes supports specific switch's commands.

The CLI Command Modes table captures the command modes, the prompts visible in that mode and the exit method from that mode.

**Table 1 CLI Command Modes**

Command Mode	Access Method	Prompt	Exit or Access Previous Mode
User Mode	This is the first level of access. Perform basic tasks and list system information.	COMMAND>	Enter <b>Logout</b> command
Privileged Mode	From the User Mode, enter the <b>enable</b> command.	Switch#	To exit to the User Mode, enter <b>exit</b> or <b>Logout</b> .
Global Config Mode	From the Privileged Mode, enter the <b>configuration</b> command.	Switch (Config)#	To exit to the Privileged Mode, enter the <b>exit</b> command.
Interface Config Mode	From the Global Config mode, enter the <b>interface</b> <port#> command.	Switch (Interface <port#>)#	To exit to the Global Config mode, enter <b>exit</b> .

The CLI is divided into various modes. The commands in one mode are not available until the operator switches to that particular mode. The commands available to the operator at any point in time depend upon the mode. By entering a question mark (?) at the CLI prompt, it will display a list of the available commands and descriptions of the commands.

The CLI provides the following modes:

#### User Mode

When the operator logs into the CLI, the User Mode is the initial mode. The User Mode contains a limited set of commands. The command prompt shown at this level is:

Command Prompt: COMMAND>

#### Privileged Mode

To have access to the full suite of commands, the operator must enter the Privileged Mode. The Privileged Mode requires password authentication. From Privileged Mode, the operator can issue any Exec command to enter the Global Configuration mode. The command prompt shown at this level is:

Command Prompt: Switch#

## Global Config Mode

This mode permits the operator to make modifications to the running configuration. General setup commands are grouped in this mode. From the Global Configuration mode, the operator can enter the Interface Configuration mode. The command prompt at this level is:

Command Prompt: Switch(Config)#

From the Global Config mode, the operator may enter the following configuration modes:

## Interface Config Mode

Many features are enabled for a particular interface. The Interface commands enable or modify the operation of an interface. In this mode, a physical port is set up for a specific logical connection operation. The command prompt at this level is:

Command Prompt: Switch(Interface <port#>)#

### 3.3 Privileged Mode commands

Commands	Description	Syntax
<b>cable-diag</b>	This command is used to proceed cable diagnostic	<b>Format</b> cable-diag port <port ID> <b>Mode</b> Privileged Mode  e.g. Switch#cable-diag port 1
<b>clear</b>	<b>1) clear arl</b> This command is used to clear ARL table entries	
	<b>1.1) clear arl dynamic</b> This command is used to Clear dynamic arl table entries	<b>Format</b> clear arl dynamic <b>Mode</b> Privileged Mode
	<b>1.2) clear arl static</b> This command is used to clear static arl table entries	<b>Format</b> clear arl static mac <mac-addr> <b>Mode</b> Privileged Mode
	<b>2) clear config</b> This command is used to restore switch factory default configuration	<b>Format</b> clear config <b>Mode</b> Privileged Mode
	<b>3) clear counters</b> This command is used to clear RMON statistics for entire switch	<b>Format</b> clear counters <b>Mode</b> Privileged Mode
	<b>4) clear igmpsnooping</b> This command is used to restore igmpsnooping configuration to factory default	<b>Format</b> clear igmpsnooping <b>Mode</b> Privileged Mode
	<b>5) clear static-mcast</b> This command is used to clear static multicast groups	<b>Format</b> clear static-mcast <b>Mode</b> Privileged Mode
	<b>6) clear pass</b> This command is used to restore administrator's password to factory default	<b>Format</b> clear pass <b>Mode</b> Privileged Mode

Commands	Description	Syntax
	<b>7) clear lacp</b> This command is used to restore LAG and LACP configuration to factory default	<b>Format</b> clear lacp <b>Mode</b> Privileged Mode
	<b>8) clear logs</b> This command is used to clear memory/flash logs	<b>Format</b> clear logs <b>Mode</b> Privileged Mode
	<b>9) clear vlan</b> This command is used to delete all VLAN groups	<b>Format</b> clear vlan <b>Mode</b> Privileged Mode
<b>configuration</b>	Enter into Global Configuration mode	<b>Format</b> configuration <b>Mode</b> Privileged Mode
	This command is used to upload file from switch to host, or download file to switch from host	
<b>copy</b>	<b>1) copy nvram_config</b> This command is used to backup switch configuration e.g. Switch#copy nvram_config tftp 192.168.1.100 file switch_configuration	<b>Format</b> copy nvram_config tftp <A.B.C.D> file <filename> <b>Mode</b> Privileged Mode
	<b>2) copy system_image</b> This command is used to backup switch runtime image e.g. Switch#copy system_image tftp	<b>Format</b> copy system_image tftp <A.B.C.D> <filename> <b>Mode</b> Privileged Mode 192.168.1.100 image_file
	<b>3) copy tftp</b> This command is used to download configuration or runtime image from host to switch. e.g. Switch#copy tftp 192.168.1.100 file switch_configuration nvram_config  Switch#copy tftp 192.168.1.100 file runtime_code system_image	<b>Format</b> copy tftp <A.B.C.D> file <filename> {nvram_config   system_image} <b>Mode</b> Privileged Mode
<b>exit</b>	This command is used to exit current shell	<b>Format</b> exit <b>Mode</b> Privileged Mode
<b>help</b>	This command displays help information	<b>Format</b> help <b>Mode</b> Privileged Mode
<b>logout</b>	This command is used to exit current shell	<b>Format</b> logout <b>Mode</b> Privileged Mode
<b>ping</b>	This command is used to proceed ping destination host	<b>Format</b> ping <A.B.C.D> <b>Mode</b> Privileged Mode
<b>reload</b>	This command is used to reboot system	<b>Format</b> reload <b>Mode</b> Privileged Mode
<b>save</b>	This command is used to save configuration	<b>Format</b> save <b>Mode</b> Privileged Mode
<b>show</b>	This command is used to show configured data	
	<b>1.1) show qos cos</b> This command displays the cos mapping	<b>Format</b> show qos cos <b>Mode</b> Privileged Mode

Commands	Description	Syntax
	<b>1.2) show qos queue-settings</b> This command displays the queue-settings mapping	<b>Format</b> show qos queue-settings <b>Mode</b> Privileged Mode
	<b>1.3) show qos advanced</b> This command displays qos advanced mode information	
	<b>1.3.1) show qos advanced mode</b> This command displays mode of qos	<b>Format</b> show qos advanced mode <b>Mode</b> Privileged Mode
	<b>1.3.2) show qos advanced dscp</b> This command displays qos dscp mapping	<b>Format</b> show qos advanced dscp <b>Mode</b> Privileged Mode
	<b>1.3.3) show qos advanced ip-precedence</b> This command displays qos ip precedence mapping	<b>Format</b> show qos advanced ip-precedence <b>Mode</b> Privileged Mode
	<b>1.4) show qos port-based</b> This command is used to displays class of service information	
	<b>1.4.1) show qos port-based port</b> This command displays class of service information	<b>Format</b> show qos port-based port <port-ID> <b>Mode</b> Privileged Mode
	<b>1.4.2) show qos port-based all</b> This command displays all switch interfaces' cos settings	<b>Format</b> show qos port-based all <b>Mode</b> Privileged Mode
	<b>2) show dot1x</b> This command displays dot1x information	
	<b>2.1) show dot1x config</b> This command displays dot1x and port configuration	<b>Format</b> show dot1x config <b>Mode</b> Privileged Mode
	<b>2.2) show dot1x radius</b> This command displays radius configuration	<b>Format</b> show dot1x radius <b>Mode</b> Privileged Mode
	<b>2.3) show dot1x statistics</b> This command displays dot1x statistics	<b>Format</b> show dot1x statistics <b>Mode</b> Privileged Mode
	<b>3) show igmpsnooping</b> This command displays IGMP snooping information	
	<b>3.1) show igmpsnooping dynamic_router_port</b> This command displays dynamic router ports information	<b>Format</b> show igmpsnooping dynamic_router_port <b>Mode</b> Privileged Mode
	<b>3.2) show igmpsnooping groups</b> This command is used to displays igmp groups information	<b>Format</b> show igmpsnooping groups <b>Mode</b> Privileged Mode
	<b>3.3) show igmpsnooping info</b> This command displays IGMP Snooping configuration information	<b>Format</b> show igmpsnooping info <b>Mode</b> Privileged Mode
	<b>5) show lag</b> This command is used to displays link aggregation groups information	
	<b>5.1) show lag lag-index</b> This command is used to specify an switch lag	<b>Format</b> show lag lag-index <lag-id> <b>Mode</b> Privileged Mode
	<b>5.2) show lag all</b> This command is used to displays all switch lags	<b>Format</b> show lag all <lag-id> <b>Mode</b> Privileged Mode

Commands	Description	Syntax
	<b>6) show lldp</b> This command is use to displays lldp statistics	
	<b>6.1) show lldp statistic</b> This command is used to displays lldp statistic	<b>Format</b> show lldp statistic <b>Mode</b> Privileged Mode
	<b>6.2) show lldp local</b> This command is used to displays local information	<b>Format</b> show lldp local <b>Mode</b> Privileged Mode
	<b>6.3) show lldp msap</b> This command is used to displays msap information	<b>Format</b> show lldp msap <b>Mode</b> Privileged Mode
	<b>6.4) show lldp msap-entry</b> This command is used to displays msap details information	<b>Format</b> show lldp msap-entry <1..26> <b>Mode</b> Privileged Mode
	<b>7) show logging</b> This command is used to displays trap records	
	<b>7.1) show logging memory-log</b> This command displays memory log	<b>Format</b> show logging memory-log <b>Mode</b> Privileged Mode
	<b>7.2) show logging flash-log</b> This command displays flash logs	<b>Format</b> show logging flash-log <b>Mode</b> Privileged Mode
	<b>8) show monitor</b> This command is used to displays port mirroring settings	<b>Format</b> show monitor <b>Mode</b> Privileged Mode
	<b>9) show network</b> This command is used to configuration for inband connectivity	<b>Format</b> show network <b>Mode</b> Privileged Mode
	<b>10) show port</b> This command is used to displays port mode and settings, displays port status	
	<b>10.1) show port port-index</b> This command is used to specify an switch interface	<b>Format</b> show port port-index <port-ID> <b>Mode</b> Privileged Mode
	<b>10.2) show port all</b> This command is used to displays all switch interface	<b>Format</b> show port all <b>Mode</b> Privileged Mode
	<b>11) show port-security</b> This command is used to displays port security settings	
	<b>11.1) show port-security port</b> This command is used to specify an switch interface	<b>Format</b> show port-security port <port-ID> <b>Mode</b> Privileged Mode
	<b>11.2) show port-security all</b> This command is used to displays all interfaces' status	<b>Format</b> show port-security all <b>Mode</b> Privileged Mode
	<b>12) show rate-limit</b> This command is used to displays ingress and egress rate limit information	
	<b>12.1) show rate-limit port</b> This command is used to specify an switch interface e.g. Switch#Show rate-limit port 1 Switch#Show rate-limit port g1	<b>Format</b> show rate-limit port <port-ID> <b>Mode</b> Privileged Mode
	<b>12.2) show rate-limit all</b> This command is used to displays all interfaces' status	<b>Format</b> show rate-limit all <b>Mode</b> Privileged Mode
	<b>13) show running-config</b> This command is used to displays switch running config	<b>Format</b> show running-config <b>Mode</b> Privileged Mode

Commands	Description	Syntax
	<b>14) show snmp</b> This command is used to displays all snmp config	
	<b>14.1) show snmp groups</b> This command displays all snmp groups	<b>Format</b> show snmp groups <b>Mode</b> Privileged Mode
	<b>14.2) show snmp users</b> This command displays all snmp users	<b>Format</b> show snmp users <b>Mode</b> Privileged Mode
	<b>14.3) show snmp communities</b> This command displays all snmp communities	<b>Format</b> show snmp communities <b>Mode</b> Privileged Mode
	<b>14.4) show snmp info</b> This command displays all snmp information.	<b>Format</b> show snmp info <b>Mode</b> Privileged Mode
	<b>15) show snmp</b> This command is used to displays switch snmp information	<b>Format</b> show snmp <b>Mode</b> Privileged Mode
	<b>16) show spanning-tree</b> This command displays Spanning Tree information	
	<b>16.1) show spanning-tree interface</b> This command displays RSTP ports information	
	<b>16.1.1) show spanning-tree interface port</b> This command specify an switch interface	<b>Format</b> show spanning-tree interface port<port-ID> <b>Mode</b> Privileged Mode
	<b>16.1.2) show spanning-tree interface all</b> This command displays all switch interface	<b>Format</b> show spanning-tree interface all <b>Mode</b> Privileged Mode
	<b>16.2) show spanning-tree mst</b> This command displays MST information	
	<b>16.2.1) show spanning-tree mst detailed</b> This command displays a MST instance information	<b>Format</b> show spanning-tree mst detailed <0..4094> <b>Mode</b> Privileged Mode
	<b>16.2.2) show spanning-tree mst instance</b> This command displays ports information on a MST instance	<b>Format</b> show spanning-tree mst instance <0..4094> <b>Mode</b> Privileged Mode
	<b>16.2.3) show spanning-tree mst summary</b> This command displays all MST instance information	<b>Format</b> show spanning-tree mst summary <b>Mode</b> Privileged Mode
	<b>16.2.4) show spanning-tree status</b> This command is used to displays spanning-tree status	<b>Format</b> show Spanning-tree status <b>Mode</b> Privileged Mode
	<b>17) show storm-control</b> This command is used to displays storm-control information	<b>Format</b> show storm-control <b>Mode</b> Privileged Mode
	<b>18) show sysinfo</b> This command is used to displays system information including system up time	<b>Format</b> show sysinfo <b>Mode</b> Privileged Mode
	<b>19) show switch</b> This command is used to displays switch information	

Commands	Description	Syntax
	<b>19.1) show switch admin-time</b> This command displays the age time of web and console	<b>Format</b> show switch admin-time <b>Mode</b> Privileged Mode
	<b>19.2) show switch age-time</b> This command displays the age time of L2 table	<b>Format</b> show switch age-time <b>Mode</b> Privileged Mode
	<b>19.3) show switch mac-table</b> This command is used to displays address resolution protocol cache	
	<b>19.3.1)show switch mac-table all</b> This command displays all element of the mac table	<b>Format</b> show switch mac-table all <b>Mode</b> Privileged Mode
	<b>19.3.2)show switch mac-table vlan</b> This command displays all mac in a specify vlan	<b>Format</b> show switch mac-table vlan <vlan-id> <b>Mode</b> Privileged Mode
	<b>19.3.3)show switch mac-table port</b> This command displays all mac in a specify port	<b>Format</b> show switch mac-table port <port-id> <b>Mode</b> Privileged Mode
	<b>19.4) show switch mcast-table</b> This command displays multicast address table	<b>Format</b> show switch mcast-table <b>Mode</b> Privileged Mode
	<b>19.5) show switch mac</b> This command displays vlan and port info by the specific mac address	<b>Format</b> show switch mac <b>Mode</b> Privileged Mode
	<b>20) show trapflags</b> This command is used to displays the value of trap flags that apply to the switch	<b>Format</b> show trapflags <b>Mode</b> Privileged Mode
	<b>21) show vlan</b> This command is used to displays vlan configuration	
	<b>21.1)show vlan member</b> This command displays vlan configuration	<b>Format</b> show vlan member <1..4094> <b>Mode</b> Privileged Mode
	<b>21.2)show vlan number</b> This command displays how many vlans has been created	<b>Format</b> show vlan number <b>Mode</b> Privileged Mode
	<b>22) show rmon</b> This command displays rmon information	
	<b>22.1) show rmon event</b>	
	<b>22.1.1) show rmon event index</b> This command displays rmon event table.	<b>Format</b> show rmon event index <1..65535> <b>Mode</b> Privileged Mode
	<b>22.1.2) show rmon event</b>	<b>Format</b> Show rmon event<CR> <b>Mode</b> Privileged Mode
	<b>22.2) show rmon event log</b> This command displays rmon event log.	<b>Format</b> Show rmon event log event_index <1..65535> <b>Mode</b> Privileged Mode
	<b>22.3) show rmon alarm</b>	
	<b>22.31) show rmon alarm index</b> This command displays rmon Alarm table.	<b>Format</b> show rmon alarm index <1..65535> <b>Mode</b> Privileged Mode
	<b>22.3.2) show rmon alarm</b>	<b>Format</b> show rmon alarm<CR> <b>Mode</b> Privileged Mode
	<b>22.4) show rmon history</b>	



Commands	Description	Syntax
	<b>22.4.1)show rmon history index</b> This command displays enabled rmon history.	<b>Format</b> show rmon history index <1..65535> <b>Mode</b> Privileged Mode
	<b>22.4.2)show rmon history &lt;CR&gt;</b>	<b>Format</b> show rmon history <CR> <b>Mode</b> Privileged Mode
	<b>22.5) show rmon statistics</b> This command displays port summary statistics.	<b>Format</b> Show rmon statistics <port-index> <b>Mode</b> Privileged Mode
	<b>23 )show poe</b> This command is used to displays poe mode and settings,displays poe port status	
	<b>23.1) show poe port-index</b> This command is used to specify an switch poe interface	<b>Format</b> show poe port-index <port-ID> <b>Mode</b> Privileged Mode
	<b>23.2)show poe all</b> This command is used to displays all switch PoE interface	<b>Format</b> show poe all <b>Mode</b> Privileged Mode
	<b>23.3)show poe system-status</b> This command is used to displays PoE system status	<b>Format</b> show poe system-status <b>Mode</b> Privileged Mode
	<b>24)show tacplus</b> This command is used to displays TACACS+ information, includes authentication type and server parameters.	<b>Format</b> show tacplus <b>Mode</b> Privileged Mode
	<b>25)show arp</b> This command is used to displays table of static ARP.	<b>Format</b> show arp <b>Mode</b> Privileged Mode
	<b>26)show acl</b> This command is used to displays information about ACL entries.	<b>Format</b> show acl <b>Mode</b> Privileged Mode
	<b>27)show dhcpsnooping</b> This command is used to display dhcp snooping information.	
	<b>27.1)show dhcpsnooping config</b> This command is used to displays dhcp snooping global configuration	<b>Format</b> show dhcpsnooping config <b>Mode</b> Privileged Mode
	<b>27.2)show dhcpsnooping port</b> This command is used to displays dhcp snooping trust port.	<b>Format</b> show dhcpsnooping port <b>Mode</b> Privileged Mode
	<b>27.3)show dhcpsnooping vlan</b> This command is used to displays dhcp snooping vlan	<b>Format</b> show dhcpsnooping vlan <b>Mode</b> Privileged Mode
	<b>27.4)show dhcpsnooping database</b> This command is used to displays dhcp snooping database entries.	
	<b>27.4.1)show dhcpsnooping database all</b> This command is used to show all dhcpsnooping entries	<b>Format</b> show show dhcpsnooping database all <b>Mode</b> Privileged Mode
	<b>27.4.2)show dhcpsnooping database static</b> This command is used to show all dhcpsnooping static entries	<b>Format</b> show show dhcpsnooping database static <b>Mode</b> Privileged Mode

Commands	Description	Syntax
	<b>27.4.3)show dhcp snooping database dynamic</b> This command is used to show all dhcp snooping dynamic entries	<b>Format</b> show show dhcp snooping database dynamic <b>Mode</b> Privileged Mode
	<b>28)show ip src guard</b> This command is used to displays the config, ports and database of the IP source Guard.	
	<b>28.1)show ip src guard config</b> This command is used to displays the configuration of IP Source Guard.	<b>Format</b> show ip src guard config <b>Mode</b> Privileged Mode
	<b>28.2)show ip src guard ports</b> This command is used to displays ports which enabled IP Source Guard	<b>Format</b> show ip src guard ports <b>Mode</b> Privileged Mode
	<b>28.3)show ip src guard database</b> This command is used to displays the database of IP Source Guard.	<b>Format</b> show ip src guard database <b>Mode</b> Privileged Mode
	<b>29)show https</b> This command is used to displays https information.	<b>Format</b> show https <b>Mode</b> Privileged Mode
	<b>30)show loop detect</b> This command is used to displays self loop detect information	<b>Format</b> show loop detect <b>Mode</b> Privileged Mode
<b>telnet</b>	This command is used to telnet the other host.	<b>Format</b> telnet <A.B.C.D> <b>Mode</b> Privileged Mode

### 3.4 Global Config mode commands

Commands	Description	Syntax
<b>exit</b>	This command is used to exit current shell	<b>Format</b> exit <b>Mode</b> Global Config
<b>vlan</b>	This command is used to configure vlan	
	<b>1) vlan add</b> This command is used to create a new vlan or some vlans	
	<b>1.1) vlan add number</b> This command enter a vlan ID	<b>Format</b> vlan add number <vlan-ID> <b>Mode</b> Global Config
	<b>1.2) vlan add range</b> This command enter a range of vlan ID	<b>Format</b> vlan add range from <vlan-ID > to <vlan-ID> <b>Mode</b> Global Config
	<b>2) vlan delete</b> This command remove a existed vlan	<b>Format</b> vlan delete <vlan-ID> <b>Mode</b> Global Config
	<b>3) vlan port</b> This command is used to configure 802.1Q port parameters for vlans	
	<b>3.1) vlan port all</b> This command is used to configure all ports	
	<b>3.1.1) vlan port all port configure</b> This command is used to configure ports in a specific vlan	<b>Format</b> vlan port all port configure <vlan-ID> <b>Mode</b> Global Config
	<b>3.1.2) vlan port all protected</b> This command is used to configure protected ports	<b>Format</b> vlan port all protected {enable disable} <b>Mode</b> Global Config
	<b>3.1.3) vlan port all pvid</b> This command is used to configure port pvid	<b>Format</b> vlan port all pvid <vlan-ID> <b>Mode</b> Global Config

Commands	Description	Syntax
	<b>3.2) vlan port ports</b> This command is used to configure multiple ports	
	<b>3.2.1) vlan port ports port-configure</b> This command is used to configure ports in a specific vlan	<b>Format</b> vlan port ports port-configure <vlan-ID> <b>Mode</b> Global Config
	<b>3.2.2) vlan port ports protected</b> This command is used to configure protected ports	<b>Format</b> vlan port ports protected {enable disable} <b>Mode</b> Global Config
	<b>3.2.3) vlan port ports pvid</b> This command is used to configure port vid	<b>Format</b> vlan port ports pvid < vlan-ID> <b>Mode</b> Global Config
	<b>4) vlan lag</b> This command is used to configure lag to a special vlan	
	<b>4.1) vlan lag vlan &lt; vlan-id&gt; exclude</b> This command is used to remove lag from a vlan	<b>Format</b> vlan lag vlan < vlan-ID> exclude lags <lag-ID> <b>Mode</b> Global Config
	<b>4.2) vlan lag vlan &lt;vlan-ID&gt; untagged</b> This command is used to set to untagged lag.	<b>Format</b> vlan lag vlan <vlan-ID> untagged lags <lag-ID> <b>Mode</b> Global Config
	<b>4.3) vlan lag vlan &lt;vlan-ID&gt; tagged</b> This command is used to set to tagged lag.	<b>Format</b> vlan lag vlan <vlan-ID> tagged lags <lag-ID> <b>Mode</b> Global Config
<b>bridge</b>	This command is used to configure switch aging time	<b>Format</b> bridge aging-time <0-1048575> <b>Mode</b> Global Config
<b>lacp-syspri</b>	This command is used to configure lacp system priority	<b>Format</b> lacp-syspri system-priority <0-65535> <b>Mode</b> Global Config
	This command is used to configure link aggregation	
	<b>1) link-aggregation addport</b> This command is used to configure LAG groups	<b>Format</b> Link-Aggregation addport lag <LAG-ID> <b>Mode</b> Global Config
	<b>2) link aggregation delport</b> This command remove ports from LAG	
	<b>2.1) Link Aggregation delport all</b> This command remove all ports from a LAG	<b>Format</b> link-aggregation-delport all lag <LAG-ID> <b>Mode</b> Global Config
	<b>2.2) link aggregation delport lag</b> This command remove specify LAG group	<b>Format</b> link aggregation delport lag <LAG-ID> <b>Mode</b> Global Config
	<b>1) lldp enable</b> This command is used to enable lldp functions	<b>Format</b> lldp enable <b>Mode</b> Global Config
	<b>2) lldp disable</b> This command is used to disable lldp functions	<b>Format</b> lldp disable <b>Mode</b> Global Config
	<b>3) lldp adv-interval</b> This command is used to specify advertised interval in seconds	<b>Format</b> lldp adv-interval <5-32768> <b>Mode</b> Global Config
	<b>4) lldp fast-startcnt</b> This command is used to specify fast-start count	<b>Format</b> lldp fast-startcnt <1-10> <b>Mode</b> Global Config
	<b>5) lldp hold</b> This command is used to specify hold value	<b>Format</b> lldp hold <2-10> <b>Mode</b> Global Config

Commands	Description	Syntax
	<b>6) lldp notify-interval</b> This command is used to specify notification interval in seconds	<b>Format</b> lldp notify-interval <5-3600> <b>Mode</b> Global Config
	<b>7) lldp reinit-delay</b> This command is used to specify re-initialization delay in seconds	<b>Format</b> lldp reinit-delay <1-10> <b>Mode</b> Global Config
	<b>8) lldp tx-delay</b> Transmit Delay in seconds	<b>Format</b> lldp tx-delay <1-8192> <b>Mode</b> Global Config
	<b>9) lldp mgmt-adddrxport</b> A range of ports can be set.	<b>Format</b> lldp mgmt-adddrxport ports <port list> <b>Mode</b> Global Config e.g. switch(config)# lldp mgmt-adddrxport ports 1 switch(config)# lldp mgmt-adddrxport ports 1-4
<b>log</b>	This command is used to configure log server	
	<b>1) log log-server</b> This command is used to configure log server	
	<b>1.1) log log-server name &lt;WORD&gt;add</b> This command is used to specify log server name, enter a name, up to 12 characters, add a log server IP address	<b>Format</b> log log-server name <WORD> add ipaddr word <b>Mode</b> Global Config
	<b>1.2) log log-server name &lt;word&gt; delete</b> This command is used to delete a log server	<b>Format</b> log log-server name <WORD> delete <b>Mode</b> Global Config
	<b>2) log logging-target</b> This command is used to configure log notification level	
	<b>2.1) log logging-target memory</b> This command is used to specify memory log notify-level	<b>Format</b> log logging-target memory {enable disable} <b>Mode</b> Global Config
	<b>2.2) log logging-target flash</b> This command is used to specify flash log notify-level	<b>Format</b> log logging-target flash {enable disable} <b>Mode</b> Privileged Mode
	<b>2.3) log logging-target console</b> This command is used to specify console log notify-level	<b>Format</b> log logging-target console {enable disable} <b>Mode</b> Global Config
<b>2.4) log logging-target server</b> This command is used to specify console log notify-level	<b>Format</b> log logging-target server name <WORD> {enable disable} <b>Mode</b> Global Config	
<b>radius-server</b>	This command is used to configure radius server	<b>Format</b> radius-server ip <IP addr> <b>Mode</b> Global Config
<b>static-address</b>	This command is used to specify static address	
	<b>1) static-address add</b> This command is used to add static mac address	<b>Format</b> static-address add <mac addr> vid <vlan-ID> port <port-ID> <b>Mode</b> Global Config
	<b>2) static-address delete</b> This command is used to delete static mac address	<b>Format</b> static-address delete <mac addr> vid <vlan-ID> <b>Mode</b> Global Config
<b>mgmt-accesslist</b>	<b>1) mgmt-accesslist ipaddr</b> This command specifies a management access IP for the DUT, up to 8 IP address can be set.	<b>Format</b> mgmt-accesslist ipaddr <IP addr> <b>Mode</b> Global Config

Commands	Description	Syntax
	<b>2) mgmt-accesslist enable</b> This command enables management access list. Only the IP address specified in the management list is allowed to access DUT.	<b>Format</b> mgmt-accesslist enable <b>Mode</b> Global Config
	<b>3) mgmt-accesslist disable</b> This command disables management access list.	<b>Format</b> mgmt-accesslist disable <b>Mode</b> Global Config
monitor	<b>1) monitor enable</b> This command enables port mirroring.	<b>Format</b> monitor enable <b>Mode</b> Global Config
	<b>2) monitor disable</b> This command disables port mirroring.	<b>Format</b> monitor disable <b>Mode</b> Global Config
	<b>3) monitor des</b> Configure destination port.	
	<b>3.1) monitor des &lt;port-ID&gt; probetype bidirection</b> This command configures port monitor probetype as bi-direction traffic.	<b>Format</b> monitor des <port-ID> probetype bidirection src <port list> <b>Mode</b> Global Config e.g. Switch(config)# monitor des 1 probetype bidirection src 2-8
	<b>3.2) monitor des &lt;port-ID&gt; probetype ingress</b> This command configures port monitor probetype as ingress traffic.	<b>Format</b> monitor des <port-ID> probetype ingress src <port list> <b>Mode</b> Global Config e.g. Switch(config)# monitor des 1 probetype ingress src 2-8
<b>3.3) monitor des &lt;port-ID&gt; probetype egress</b> This command configures port monitor probetype as egress traffic.	<b>Format</b> monitor des <port-ID> probetype egress src <port list> <b>Mode</b> Global Config e.g. Switch(config)# monitor des 1 probetype egress src 2-8	
dot1x	<b>1) dot1x enable</b> This command enables global 802.1x function.	<b>Format</b> dot1x enable <b>Mode</b> Global Config
	<b>2) dot1x disable</b> This command disables global 802.1x function.	<b>Format</b> dot1x disable <b>Mode</b> Global Config
	<b>3) dot1x port-control</b> Configure port auto-authentication mode.	
	<b>3.1) dot1x port-control enable</b> This command set auto-authorized on a list of ports.	<b>Format</b> dot1x port-control enable port <port list> <b>Mode</b> Global Config
	<b>3.2) dot1x port-control disable</b> This command set force authorized on a list of ports.	<b>Format</b> dot1x port-control disable port <port list> <b>Mode</b> Global Config e.g. Switch(config)# dot1x port-control disable port 1-4
network	<b>1) network mgmt-vlan</b> This command changes management vlan.	<b>Format</b> network mgmt-vlan <vlan-ID> <b>Mode</b> Global Config
	<b>2) network parms</b> This command configures static IP address of the switch.	<b>Format</b> network parms <IP addr> <subnet mask> <gateway> <b>Mode</b> Global Config
	<b>3) network protocol</b> This command configure switch dhcp client.	<b>Format</b> network protocol {dhcp none} <b>Mode</b> Global Config
	<b>4) network dhcp-relay</b> Configure switch dhcp relay functions	

Commands	Description	Syntax
	<b>4.1) network dhcp-relay mode</b> This command configures dhcp relay mode.	<b>Format</b> network dhcp-relay mode {enable disable} <b>Mode</b> Global Config
	<b>4.2) network dhcp-relay server</b> This command configures dhcp-relay server ip-address.	<b>Format</b> network dhcp-relay server <A.B.C.D> <b>Mode</b> Global Config
	<b>4.3) network dhcp-relay vlan</b> Configure dhcp-relay option-82 vlan information.	
	<b>4.3.1) network dhcp-relay vlan &lt;vlan-ID&gt; add</b> This command enters a vlan which will be enable DHCP-relay option82.	<b>Format</b> network dhcp-relay vlan <vlan-ID> add <b>Mode</b> Global Config
	<b>4.3.2) network dhcp-relay vlan &lt;vlan-ID&gt; remove</b> This command enters a vlan which will be disable dhcp-relay option82.	<b>Format</b> network dhcp-relay vlan <vlan-ID> remove <b>Mode</b> Global Config
	<b>5) network sysinfo</b> Configure switch system information.	
	<b>5.1) Network sysinfo sysname</b> This command configures system name.	<b>Format</b> network sysinfo sysname <WORD> <b>Mode</b> Global Config
	<b>5.2) network sysinfo syslocate</b> This command configures system location.	<b>Format</b> network sysinfo syslocate <WORD> <b>Mode</b> Global Config
	<b>5.3) network sysinfo syscontact</b> This command configures system contact information.	<b>Format</b> network sysinfo syscontact <WORD> <b>Mode</b> Global Config
	<b>6) network admin-timeout</b> This command configures web/console admin time out interval. '0' means disable.	<b>Format</b> network admin-timeout <0-65535> <b>Mode</b> Global Config
port-all	<b>1) port-all admin-mode</b> This command configures ports admin mode.	<b>Format</b> port-all admin-mode {enable   disable} <b>Mode</b> Global Config
	<b>2) port-all auto-negotiate</b> This command configures ports auto-negotiation mode.	<b>Format</b> port-all auto-negotiate {enable disable} <b>Mode</b> Global Config
	<b>3) port-all flow-control</b> This command configures ports flow control.	<b>Format</b> port-all flow-control {enable disable} <b>Mode</b> Global Config
	<b>4) port-all portsec-lockmode</b> Configure port security.	
	<b>4.1) port-all portsec-lockmode none</b> This command disable port security	<b>Format</b> port-all portsec-lockmode none <b>Mode</b> Global Config
	<b>4.2) port-all portsec-lockmode dynamic</b> This command enable limited dynamic lock mode.	<b>Format</b> port-all portsec-lockmode dynamic max-entries <0-24> <b>Mode</b> Global Config
	<b>5) port-all rate-limit</b> Configure rate limit value on all ports.	
	<b>5.1) port-all rate-limit egress</b> This command specifies egress rate limit.	<b>Format</b> port-all Rate-Limit egress <value> <b>Mode</b> Global Config
	<b>5.2) port-all rate-limit ingress</b> This command specifies ingress rate limit.	<b>Format</b> port-all rate-limit ingress <value> <b>Mode</b> Global Config

Commands	Description	Syntax
	<b>6) port-all rmon-counter</b> This command configures rmon counter capability on ports.	<b>Format</b> port-all rmon-counter {enable disable} <b>Mode</b> Global Config
	<b>7) port-all speed</b> This command configures ports speed.	<b>Format</b> port-all speed {10hd 10fd 100hd 100fd} <b>Mode</b> Global Config
	<b>8) port-all storm-control</b> Configure all ports' storm control settings.	
	<b>8.1) port-all storm-control disable</b> This command disables storm control.	<b>Format</b> port-all Storm-Control disable <b>Mode</b> Global Config
	<b>8.2) port-all storm-control broadcast</b> This command configures storm control for broadcast only.	<b>Format</b> port-all storm-control broadcast <value> <b>Mode</b> Global Config
	<b>8.3) port-all storm-control broadcast-multicast</b> This command configures storm control for broadcast and multicast.	<b>Format</b> port-all Storm-Control broadcast-multicast <value> <b>Mode</b> Global Config
	<b>8.4) port-all storm-control broadcast-unknown</b> This command configures storm control for broadcast and unknown unicast.	<b>Format</b> port-all storm-control broadcast-unknown <value> <b>Mode</b> Global Config
	<b>8.5) port-all storm-control all-cast</b> This command configures storm control for broadcast, multicast and unknown unicast.	<b>Format</b> port-all Storm-Control all-cast <value> <b>Mode</b> Global Config
<b>qos</b>	<b>1) qos qos-advanced</b> Configure qos advanced mode.	
	<b>1.1) qos qos-advanced DSCP</b> This command enables DSCP mode.	<b>Format</b> qos qos-advanced DSCP <b>Mode</b> Global Config
	<b>1.2) qos qos-advanced ip_precedence</b> This command enables IP Precedence mode.	<b>Format</b> qos qos-advanced ip_precedence <b>Mode</b> Global Config
	<b>1.3) qos qos-advanced none</b> This command disables qos advanced mode.	<b>Format</b> qos qos-advanced none <b>Mode</b> Global Config
	<b>2) qos cos</b> This command configures 802.1p priority queue mapping.	<b>Format</b> Qos cos priority <0-7> queue <1-4> <b>Mode</b> Global Config
	<b>3) qos dscp</b> This command specifies dscp value to queue mapping.	<b>Format</b> qos dscp <0-63> queue <1-4> <b>Mode</b> Global Config
	<b>4) qos port-based</b> This command configures port-based priority mapping.	<b>Format</b> qos port-based port <WORD>status {enable   disable} <b>Mode</b> Global Config
	<b>5) qos scheduling</b> Configure qos scheduling mode.	
	<b>5.1) qos scheduling strict</b> This command sets to strict priority.	<b>Format</b> qos scheduling strict <b>Mode</b> Global Config
	<b>5.2) qos scheduling wrr</b> This command sets to Weight Round-Robin.	<b>Format</b> qos scheduling wrr <b>Mode</b> Global Config
	<b>6) qos ip-precedence</b> This command configures IP precedence queue mapping.	<b>Format</b> qos ip-precedence <0-7> queue <1-4> <b>Mode</b> Global Config

Commands	Description	Syntax
	<b>7) qos wrr</b> This command configures queue weight for weight round robin.	<b>Format</b> qos wrr weight <1-15> queue <1-4> <b>Mode</b> Global Config
set	<b>1) set IGMP</b> Configure IGMP snooping.	
	<b>1.1) set igmp enable</b> This command enables igmp snooping.	<b>Format</b> set igmp enable <b>Mode</b> Global Config
	<b>1.2) set igmp disable</b> This command disables IGMP snooping.	<b>Format</b> set igmp disable <b>Mode</b> Global Config
	<b>1.3) set igmp last-memberquery</b> This command specifies last member query interval.	<b>Format</b> set igmp last-memberquery <1-200> <b>Mode</b> Global Config
	<b>1.4) set igmp last-membercount</b> This command specifies last member count.	<b>Format</b> set igmp last-membercount <1-20> <b>Mode</b> Global Config
	<b>1.5) set igmp query-interval</b> This command specifies igmp query interval<secs>.	<b>Format</b> set igmp query-interval <10-600> <b>Mode</b> Global Config
	<b>1.6) set igmp query-resinterval</b> This command specifies igmp query response interval<secs>.	<b>Format</b> set igmp query-resinterval <0-200> <b>Mode</b> Global Config
	<b>1.7) set igmp robustness</b> This command specifies robustness variable.	<b>Format</b> set igmp robustness <1-20> <b>Mode</b> Global Config
	<b>1.8) set igmp router-port</b> This command specifies igmp router port e.g. Switch(config)# set igmp router-port ports 1-10	<b>Format</b> set igmp router-port ports <port list> <b>Mode</b> Global Config
	<b>2) set igmp-querier</b> This command configures igmp querier.	<b>Format</b> set igmp-querier {enable   disable} <b>Mode</b> Global Config
	<b>3) set igmp-proxy</b> This command configures igmp proxy.	<b>Format</b> set igmp-proxy {enable   disable} <b>Mode</b> Global Config
	<b>4) set static-mcast</b> Configure static multicast.	
	<b>4.1) set static-mcast name &lt;WORD&gt; add</b> This command create a multicast group.	<b>Format</b> set static-mcast name <WORD> add vid <vlan-ID> mac <mac-addr> member port <port list> <b>Mode</b> Global Config
	<b>4.2) set static-mcast name &lt;WORD&gt;delete</b> This command delete a static multicast group	<b>Format</b> set static-mcast name <WORD>delete <b>Mode</b> Global Config
snmp	<b>1) snmp notify</b> This command configures snmp notification.	<b>Format</b> snmp notify {enable disable} <b>Mode</b> Global Config
	<b>2) snmp group</b>	
	<b>2.1) snmp group add</b> This command create a snmp group.	<b>Format</b> snmp group add <WORD>version <1-2> <b>Mode</b> Global Config
	<b>2.2) snmp group delete</b> This command delete a snmp group.	<b>Format</b> snmp group delete <WORD> <b>Mode</b> Global Config



Commands	Description	Syntax
	<b>3) snmp user</b>	
	<b>3.1) snmp user add</b> This command creates a snmp user.	<b>Format</b> snmp user add <user name> group <group name> version <1-3> <b>Mode</b> Global Config
	<b>3.2) snmp user delete</b> This command deletes a snmp user.	<b>Format</b> snmp user delete <WORD> <b>Mode</b> Global Config
	<b>4) snmp community</b>	
	<b>4.1) snmp community add</b> This command creates a community.	<b>Format</b> snmp community add <community name> group <group name> mgmt-ip <ip-addr> <b>Mode</b> Global Config
	<b>4.2) snmp community delete</b> This command deletes a community.	<b>Format</b> snmp community delete <community name>. <b>Mode</b> Global Config
	<b>5) snmp trapstation</b>	
	<b>5.1) snmp trapstation add</b> Create a snmp trap station.	
	<b>5.1.1) snmp trapstation add &lt;ip-addr&gt; community &lt;community name&gt; type bootup</b> Send trap when system reboot	<b>Format</b> snmp trapstation add <ip-addr> community <community name> type bootup trap-version {1 2} <b>Mode</b> Global Config
	<b>5.1.2) snmp trapstation add &lt;ip-addr&gt; community &lt;community name&gt; type linkchange</b> Send trap when port link change	<b>Format</b> snmp trapstation add <ip-addr> community <community name> type linkchange trap-version {1 2} <b>Mode</b> Global Config
	<b>5.1.3) snmp trapstation add &lt;ip-addr&gt; community &lt;community name&gt; type both</b> Send trap when system reboot or port link change.	<b>Format</b> snmp trapstation add <ip-addr> community <community name> type both trap-version {1-2} <b>Mode</b> Global Config
	<b>5.1.4) snmp trapstation add &lt;ip-addr&gt; community &lt;community name&gt; type none</b> Send no trap.	<b>Format</b> snmp trapstation add <ip-addr> community <community name> type none trap-version {1-2} <b>Mode</b> Global Config
	<b>5.2) snmp trapstation delete</b> This command delete a trap station.	<b>Format</b> snmp trapstation delete <WORD> <b>Mode</b> Global Config
<b>sntp</b>	<b>1) sntp daylight</b> This command enables or disables the daylight saving configuration.	<b>Format</b> sntp daylight {enable disable} <b>Mode</b> Global Config
	<b>2) sntp localtime</b> Configure the local time.	
	<b>2.1) sntp localtime enable</b> This command enables local time.	<b>Format</b> sntp localtime enable <b>Mode</b> Global Config
	<b>2.2) sntp localtime localtime_date</b> This command sets local time.	<b>Format</b> sntp localtime localtime_date <year> <month> <date> <hour> <minute> <second> <b>Mode</b> Global Config
	<b>3) sntp server</b>	
	<b>3.1) sntp server enable</b> This command enables sntp server.	<b>Format</b> sntp server enable <b>Mode</b> Global Config
	<b>3.2) sntp server ipaddr</b> This command sets sntp server IP address.	<b>Format</b> sntp server ipaddr <IP-addr> <b>Mode</b> Global Config

Commands	Description	Syntax
	<b>3.3) snmp server polling</b> This command sets snmp server polling time interval.	<b>Format</b> snmp server polling <0-9> <b>Mode</b> Global Config
	<b>4) snmp timezone</b> This command sets snmp timezone.	<b>Format</b> snmp timezone <1-75> <b>Mode</b> Global Config
spanning-tree	<b>1) spanning-tree forceversion</b> This command configures Spanning Tree protocol version.	
	<b>1.1) spanning-tree forceversion 8021s</b> This command selects spanning tree type as 8021.s(multiple Spanning Tree).	<b>Format</b> spanning-tree forceversion 8021s <b>Mode</b> Global Config
	<b>1.2) spanning-tree forceversion 8021w</b> This command selects spanning tree type as 802.1w(rapid Spanning Tree).	<b>Format</b> spanning-tree forceversion 8021w <b>Mode</b> Global Config
	<b>1.3) spanning-tree forceversion none</b> This command selects none spanning tree type.	<b>Format</b> spanning-tree forceversion none <b>Mode</b> Global Config
	<b>2) spanning-tree configuration</b> This command configures MSTP region name and revision.	
	<b>2.1) spanning-tree configuration name</b> This command configures MSTP region name (Max.32 chars).	<b>Format</b> spanning-tree configuration name <WORD> <b>Mode</b> Global Config
	<b>2.2) spanning-tree configuration revision</b> This command configures revision level.	<b>Format</b> spanning-tree configuration revision <0-65535> <b>Mode</b> Global Config
	<b>3) spanning-tree forward-time</b> This configures the bridge forward delay parameter.	<b>Format</b> spanning-tree forward-time <4-30> <b>Mode</b> Global Config
	<b>4) spanning-tree max-age</b> This command configures the bridge max age parameter.	<b>Format</b> spanning-tree max-age <6-40> <b>Mode</b> Global Config
	<b>5) spanning-tree max-hops</b> This command configure the number of hops in a region.	<b>Format</b> spanning-tree max-hops <1-40> <b>Mode</b> Global Config
	<b>6) spanning-tree port</b>	
	<b>6.1) spanning-tree port all</b> This command specifies RSTP capability for all ports.	<b>Format</b> spanning-tree port all {enable disable} <b>Mode</b> Global Config
	<b>6.2) spanning-tree port cost</b> This command configures RSTP port path cost.	<b>Format</b> spanning-tree port cost <0-200000000> <b>Mode</b> Global Config
	<b>6.3) spanning-tree port priority</b> This command configures RSTP port priority.	<b>Format</b> spanning-tree port priority <0-24> <b>Mode</b> Global Config
	<b>6.4) spanning-tree port edge</b> This command configures STP edge	<b>Format</b> spanning-tree port edge {enable disable} ports <port-list> <b>Mode</b> Global Config
	<b>6.5) spanning-tree port force-p2plink</b> This command configures force point to point link mode on ports.	<b>Format</b> spanning-tree port force-p2plink {auto enable disable} ports <port-list> <b>Mode</b> Global Config

Commands	Description	Syntax
	<b>6.6) spanning-tree port migration-check</b> This command Re-checks the appropriate BPDU format to send on ports.	<b>Format</b> spanning-tree port migration-check {enable disable} ports <port-list> <b>Mode</b> Global Config
	<b>6.7) spanning-tree port root-guard</b> This command is used to configure stp root guard	<b>Format</b> spanning-tree port migration-check {enable disable} ports <port-list> <b>Mode</b> Global Config
	<b>7) spanning-tree priority</b> This command configures RSTP bridge priority value.	<b>Format</b> spanning-tree priority <0-61440> <b>Mode</b> Global Config
	<b>8) spanning-tree mst</b> Configure a multiple spanning tree instance.	
	<b>8.1) spanning-tree mst instance</b> This command creates or removes a MST instance	
	<b>8.1.1) spanning-tree mst instance add</b> This command creates a MST instance.	<b>Format</b> spanning-tree mst instance add vlan <vlan list> mstpid <MST ID> <b>Mode</b> Global Config e.g. Switch(Config)# Spanning-Tree mst instance add vlan 2-5 mstpid 2 Switch(Config)# Spanning-Tree mst instance add vlan 6 mstpid 3
	<b>8.1.2) spanning-tree mst instance delete</b> This command removes the last MST instance.	<b>Format</b> spanning-tree mst instance delete <b>Mode</b> Global Config
	<b>8.2) spanning-tree mst vlan</b> This command adds or deletes vlan frome a MSTP instance.	
	<b>8.2.1) spanning-tree mst vlan &lt;MST ID&gt; &lt;vlan list&gt; add</b> This command creates a MST instance.	<b>Format</b> spanning-tree mst vlan <MST ID> <vlan list> add <b>Mode</b> Global Config e.g. Switch(Config)# Spanning-Tree mst vlan 3 3-5 add
	<b>8.2.2) Spanning-Tree mst vlan &lt;MST ID&gt; &lt;vlan list&gt; delete</b> This command deletes a vlan from a MST instance.	<b>Format</b> Spanning-Tree mst vlan <MST ID> < vlan list> delete <b>Mode</b> Global Config
	<b>8.3) spanning-tree mst bridgepri</b> This command configures bridge priority for a MST instance.	<b>Format</b> spanning-tree mst bridgepri <MST ID> <priority> <b>Mode</b> Global Config
	<b>8.4) spanning-tree mst cost</b> This command configures port path cost in a MST instance.	<b>Format</b> spanning-tree mst cost <MST ID> <path cost> ports <port list> <b>Mode</b> Global Config
	<b>8.5) spanning-tree mst priority</b> This command configures port priority in a MST instance	<b>Format</b> spanning-tree mst priority <MST ID> <priority> ports <port list> <b>Mode</b> Global Config
<b>User</b>	This command changes user password.	<b>Format</b> user password <b>Mode</b> Global Config
<b>Interface</b>	This command enters into configure interface mode.	<b>Format</b> Interface <port-ID> <b>Mode</b> Global Config

Commands	Description	Syntax
<b>rmon</b>	This command is used to configure RMON. <b>1) rmon event</b> This command creates rmon event entry.	<b>Format</b> rmon event index < 1..65535 > desc <WORD> event <1..4> community <WORD>owner<WORD> <b>Mode</b> Global Config e.g. Switch(Config)# rmon event index 1 desc 123 event 4 community 123 owner test
	<b>2) rmon alarm</b> This command creates rmon alarm entry. e.g. Switch(Config)# RMON alarm index 1 interval 10 interface counter 1 sample delta start all rthreshold 100 fthreshold 10 reindex 1 feindex 0 owner test	<b>Format</b> rmon alarm index < 1..65535 > interval <0..3600> interface <port number> counter <1..17> sample{absolute delta}start{rasi ng falling all}rthreshold<0..6553 5>fthreshold<0..65535> reindex <0..65535> feindex <0..65535> owner<WORD> <b>Mode</b> Global Config
	<b>3) rmon del</b>	
	<b>3.1) rmon del event</b> This command deletes rmon event entry.	<b>Format</b> rmon del event index< 1..65535 > <b>Mode</b> Global Config
	<b>3.2) rmon del alarm</b> This command deletes rmon alarm entry.	<b>Format</b> rmon del alarm index< 1..65535 > <b>Mode</b> Global Config
	<b>access list</b>	<b>1) access-list name &lt;WORD&gt; add</b> This command creates a new access-list.
<b>2) access-list name &lt;WORD&gt; action</b>		
<b>2.1) access-list name &lt;WORD&gt; action deny</b> This command denies an ACL entry.		<b>Format</b> access-list name <WORD> action deny <b>Mode</b> Global Config
<b>2.2) access-list name &lt;WORD&gt; action permit</b> This command permits an ACL entry and queue 1-4 will assign priority queue when rule activated.		<b>Format</b> access-list name <WORD> action permit {<cr> queue <1-4>} <b>Mode</b> Global Config
<b>3) access-list name &lt;WORD&gt; clear</b> This command clears ACL entry contents.		
<b>3.1) access-list name &lt;WORD&gt; clears SRC IP</b> This command clears the source IP/subnet mask filter.		<b>Format</b> access-list name <WORD> clear SRC IP <b>Mode</b> Global Config
<b>3.2) access-list name &lt;WORD&gt; clears DST IP</b> This command clears the destination IP/subnet mask filter.		<b>Format</b> access-list name <WORD> clear DST IP <b>Mode</b> Global Config
<b>3.3) access-list name &lt;WORD&gt; clear L4port</b>		
<b>3.3.1) access-list name &lt;WORD&gt; clear L4port SRC port</b> This command clears TCP/UDP source port filter.		<b>Format</b> access-list name <WORD> clear l4port SRC port <b>Mode</b> Global Config
<b>3.3.2) access-list name &lt;WORD&gt; clear l4port DST port</b> This command clears TCP/UDP destination port filter.		<b>Format</b> access-list name <WORD> clear l4port DST port <b>Mode</b> Global Config

Commands	Description	Syntax
	<b>3.4) access-list name &lt;WORD&gt; clear packet-type</b> This command clears packet type filter.	<b>Format</b> access-list name <WORD> clear packet-type <b>Mode</b> Global Config
	<b>3.5) access-list name &lt;WORD&gt; clear mac SA</b> This command clears a source mac address.	<b>Format</b> Access-list name <WORD> clear mac SA <b>Mode</b> Global Config
	<b>3.6) access-list name &lt;WORD&gt; clear MAC DA</b> This command clears a destination mac address	<b>Format</b> Access-list name <WORD> clear mac DA. <b>Mode</b> Global Config
	<b>3.7) access-list name &lt;WORD&gt; clear VID</b> This command clears the 802.1Q VLAN tag of packet.	<b>Format</b> Access-list name <WORD> clear VID <b>Mode</b> Global Config
	<b>3.8) access-list name &lt;WORD&gt; clear ether-type</b> This command clears ether type filter.	<b>Format</b> access-list name <WORD> clear ether-type <b>Mode</b> Global Config
	<b>4) access-list name &lt;WORD&gt; deletes.</b> This command removes the ACL entry.	<b>Format</b> access-list name <WORD> deletes <b>Mode</b> Global Config
	<b>5) access-list name &lt;WORD&gt; {enable disable}</b> This command enables/disables the ACL entry	<b>Format</b> access-list name <WORD> {enable disable} <b>Mode</b> Global Config
<b>6) access-list name &lt;WORD&gt; set</b>		
	<b>6.1) access-list name &lt;WORD&gt; set priority</b> This command specifies ACL entry priority.	<b>Format</b> access-list name <WORD> set priority <0-65535> <b>Mode</b> Global Config
<b>6.2) access-list name &lt;WORD&gt; set IP-mode</b>		
	<b>6.2.1) access-list name &lt;WORD&gt; set IP-mode SRC IP.</b> This command specifies a source IP address.	<b>Format</b> access-list name <WORD> set IP-mode SRC IP <IP-addr> <mask-addr> <b>Mode</b> Global Config
	<b>6.2.2) access-list name &lt;WORD&gt; set IP-mode DST IP</b> This command specifies a destination IP address.	<b>Format</b> access-list name <WORD> set IP-mode DSP IP <IP-addr> <mask-addr> <b>Mode</b> Global Config
<b>6.3) access-list name &lt;WORD&gt; set L4port</b> This command specifies the TCP/UDP port range.		
	<b>6.3.1) access-list name &lt;WORD&gt; set l4port SRC-port</b> This command specifies the source TCP/UDP port range.	Access-list name <WORD> set L4 port SRE-port from <1-65535> to <1-65535> Global Config
	<b>6.3.2) access-list name &lt;WORD&gt; set l4port DST-port</b> This command specifies the destination TCP/UDP port range.	access-list name <WORD> set l4port DST-port from <1-65535> to <1-65535> Global Config
	<b>6.4) access-list name &lt;WORD&gt; set IP-mode packet-type</b> This command specifies the packet type.	access-list name <WORD> set IP-mode packet-type {ICMP IGMP IP TCP UDP GRE} Global Config
<b>6.5) access-list name &lt;WORD&gt; set mac-mode</b> Specify ACL entry priority.		

Commands	Description	Syntax
	<b>6.5.1) access-list name &lt;WORD&gt; set mac-mode mac SA</b> This command specifies a source mac address.	access-list name <WORD> set mac-mode mac SA <mac-addr> <mask-addr> Global Config
	<b>6.5.2) access-list name &lt;WORD&gt; set mac-mode mac DA</b> This command specifies a destination mac address.	access-list name <WORD> set mac-mode mac DA <mac-addr> <mask-addr> Global Config
	<b>6.6) access-list name &lt;WORD&gt; set mac-mode ether-type</b> This command specifies the ether type of the packet.	access-list name <WORD> set mac-mode ether-type {ipv4 ARP xns} Global Config
	<b>7) access-list name &lt;name&gt; set portlist</b>  This command is used to specify an acl entry to be work on a list of ports.	<b>Format</b> access-list name <name> set portlist <LINE   port_id> <b>Mode</b> Global Config
	<b>1) arp dynamic</b>	
	<b>1.1) arp dynamic enables and disables.</b> This command enables and disables dynamic arp functions.	<b>Format</b> arp dynamic {enable disable} <b>Mode</b> Global Config
	<b>1.2) arp dynamic aging-time</b> This command set arp dynamic aging-time between 0s and 999s. "0" means disable.	arp dynamic aging-time <0~999> Global Config
	<b>1.3) arp dynamic ports</b> This command set dynamic arp ports to trust and un-trust.	arp dynamic ports {trust untrust} <port-list> Global Config e.g. Switch<Config># arp dynamic ports trust 1-4 Config># arp dynamic ports untrust 4
	<b>1.4) arp dynamic vlan</b> This command set add/remove dynamic arp on specified vlan.	<b>Format</b> arp dynamic vlan {add remove} from < vlan -id> to < vlan -id> <b>Mode</b> Global Config e.g. Switch<Config># arp dynamic vlan add from 1 to 1 Switch<Config># arp dynamic vlan remove from 1 to 1
	<b>2) arp static command</b> This command set arp static address table for mac address with IP Address.	<b>Format</b> arp static {add delete} vid <1~4094> ip <A.B.C.D> mac <mac-address> <b>Mode</b> Global Config
<b>dos</b>		
	<b>1) dos land</b> This command enables and disables land-type attacks prevention.	<b>Format</b> dos land {enable disable} <b>Mode</b> Global Config
	<b>2) dos blat</b> This command enables and disables blat-type attack prevention.	<b>Format</b> dos blat {enable disable} <b>Mode</b> Global Config
	<b>3) dos syn-fin</b> This command enables and disables SYN-fin-type attack prevention.	<b>Format</b> dos syn-fin {enable disable} <b>Mode</b> Global Config
	<b>4) dos ports</b>	

Commands	Description	Syntax
	4.1) dos ports smurf This command enables and disables Smurf-TYPR attack prevention.	dos ports smurf {enable disable} Global Config
	4.2)dos ports ping-flooding This command enables and disables ping-flooding-type attack prevention.	dos ports ping-flooding {enable disable} Global Config
	4.3)dos ports synack-flooding This command enables and disables SYNACK -flooding -type attack prevention. Set rate is 64 kbps or 128kbps for port lists (1, 3-5, 7-9.11)	<b>Format</b> dos ports synack -flooding {enable disable} rate {64 128} <port-list> <b>Mode</b> Global Config e.g. Switch<Config>#dos ports synack -flooding enablerate 64 1-4 Switch<Config>#dos ports synack -flooding enablerate 64 5
<b>tacplus</b>	<b>1) tacplus authen_type</b> This command is used to set authentication type. There are three types for selecting: local, tacplus, localandtacplus	tacplus authen_type {local   tacplus   localandtacplus} Global Config
	<b>2) tacplus add</b> This command is used to add a new TACACS+ server and set server IP address, priority, key string, authentication port and timeout for reply	acplus add server <IP_addr> priority <0-65535> key <key string> port <auth port id> timeout <1-30> Global Config
	<b>3) tacplus del</b> This command is used to delete a TACACS+ server.	<b>Format</b> tacplus del server <IP_addr> <b>Mode</b> Global Config
<b>green-eth</b>	This command is used to enable/disable green Ethernet function. Enable green Ethernet mode will reduce system power consumption when the link is not present.	<b>Format</b> green-eth { enable   disable } <b>Mode</b> Global Config
<b>Dhcpsnooping</b>	<b>1)dhcpsnooping enable</b> This command is used to enable dhcp snooping functions.	<b>Format</b> dhcpsnooping enable <b>Mode</b> Global Config
	<b>2)dhcpsnooping disable</b> This command is used to disable dhcp snooping functions.	<b>Format</b> dhcpsnooping enable <b>Mode</b> Global Config
	<b>3)dhcpsnooping option82</b> This command is used to set option82 packets.	<b>Format</b> dhcpsnooping option82 {enable disable} <b>Mode</b> Global Config
	<b>4)dhcpsnooping verifymac enable</b> This command is used to set verify mac address	<b>Format</b> dhcpsnooping verifymac{enable disable} <b>Mode</b> Global Config
	<b>5)dhcpsnooping ports</b> This command is used to set ports to trust or untrust.	
	<b>5.1)dhcpsnooping ports trust</b> This command is used to set ports to trust	<b>Format</b> dhcpsnooping ports trust <port-list> <b>Mode</b> Global Config
	<b>5.2)dhcpsnooping ports untrust</b> This command is used to set ports to untrust	<b>Format</b> dhcpsnooping ports untrust <port-list> <b>Mode</b> Global Config
	<b>6)dhcpsnooping vlan</b> This command is used to configure dhcp vlan.	

Commands	Description	Syntax
	<b>6.1)dhcp snooping vlan add</b> This command is used to enable dhcp snooping in a specified vlan.	<b>Format</b> dhcp snooping vlan add from <vlan-id> to <vlan-id> <b>Mode</b> Global Config
	<b>6.2)dhcp snooping vlan</b> This command is used to disable dhcp snooping in a specified vlan.	<b>Format</b> dhcp snooping vlan remove from <vlan-id> to <vlan-id> <b>Mode</b> Global Config
	<b>7)dhcp snooping static</b> This command is used to configure dhcp static entry.	
	<b>7.1)dhcp snooping static add</b> This command is used to add a static dhcp entry.	<b>Format</b> dhcp snooping static add ip <A.B.C.D> mac <mac-address> port <port-id> vid <vlan-id> <b>Mode</b> Global Config
	<b>7.2)dhcp snooping static delete</b> This command is used to delete a static dhcp entry.	<b>Format</b> dhcp snooping static delete ip <A.B.C.D> mac <mac-address> port <port-id> vid <vlan-id> <b>Mode</b> Global Config
	<b>8)dhcp snooping dynamic</b> This command is used to configure dhcp dynamic entry.	
	<b>8.1)dhcp snooping dynamic add</b> This command is used to add a dynamic dhcp entry	<b>Format</b> dhcp snooping dynamic add ip <A.B.C.D> mac <mac-address> port <port-id> vid <vlan-id> lease-time <1..9999999> <b>Mode</b> Global Config
	<b>8.2)dhcp snooping dynamic delete</b> This command is used to delete a dynamic dhcp entry.	<b>Format</b> dhcp snooping dynamic delete ip <A.B.C.D> mac <mac-address> port <port-id> vid <vlan-id> lease-time <1..9999999> <b>Mode</b> Global Config
<b>Loop_detect</b>	<b>1)Loop_detect enable</b> This command is used to enable port self-loop detection.	<b>Format</b> loop_detect enable <b>Mode</b> Global Config
	<b>2)loop_detect disable</b> This command is used to disable port self-loop detection.	<b>Format</b> loop_detect disable <b>Mode</b> Global Config
	<b>3)loop_detect recovertime</b> This command is used to set the recover time.	<b>Format</b> loop_detect recovertime <0..65535> <b>Mode</b> Global Config
	<b>4)loop detect trytorecover</b> This command is used to try to recover all the selfloop port immediately	<b>Format</b> loop_detect trytorecover <b>Mode</b> Global Config
<b>https</b>	This command is used to set https enable or disable.	<b>Format</b> https { enable   disable } <b>Mode</b> Global Config
<b>BOOTP</b>	<b>1)bootp enable</b> This command is used to enable bootp function.	<b>Format</b> bootp enable <b>Mode</b> Global Config
	<b>2)bootp disable</b> This command is used to disable bootp function.	<b>Format</b> bootp disable <b>Mode</b> Global Config
	<b>3)bootp renew</b> This command is used to renew bootp.	<b>Format</b> bootp renew <b>Mode</b> Global Config
<b>SSH</b>	<b>1)ssh enable</b> This command is used to enable ssh function.	<b>Format</b> ssh enable <b>Mode</b> Global Config
	<b>2)ssh disable</b> This command is used to disable ssh function.	<b>Format</b> ssh disable <b>Mode</b> Global Config



Commands	Description	Syntax
	<b>3)ssh changekey</b> This command is used to change key function.	<b>Format</b> ssh changekey <b>Mode</b> Global Config
<b>ipsrcgd</b>	<b>1)ipsrcgd enable</b> This command is used to enable ip source guard function.	<b>Format</b> ipsrcgd enable <b>Mode</b> Global Config
	<b>2)ipsrcgd disable</b> This command is used to disable ip source guard function.	<b>Format</b> ipsrcgd disable <b>Mode</b> Global Config
	<b>3)ipsrcgd ports</b> This command is used to configure ports to enable or disable ip source guard.	<b>Format</b> ipsrcgd ports {enable disable} <b>Mode</b> Global Config
	<b>4)ipsrcgd retry</b> This command is used to configure the retry mechanism of ip source guard database.	
	<b>4.1)ipsrcgd retry now</b> This command is used to retry inactive entries now.	<b>Format</b> ipsrcgd retry now <b>Mode</b> Global Config
	<b>4.2)ipsrcgd retry interval</b> This command is used to retry inactive entries after a interval.	<b>Format</b> ipsrcgd retry interval <0-1440> <b>Mode</b> Global Config

### 3.5 Interface Config mode commands

Commands	Description	Syntax
<b>exit</b>	Exit current shell	<b>Format</b> exit <b>Mode</b> Interface Config
<b>dot1x</b>	Set 802.1x port control. Set auto-authorized or force authorized on ports	<b>Format</b> 802.1x port-control {enable disable} <b>Mode</b> Interface Config
<b>lacp</b>	<b>1) admin command</b> Configure admin key of port	<b>Format</b> lacp admin <0 ..65535> <b>Mode</b> Interface Config e.g. switch(interface g1)#lacp admin 36768
	<b>2) priority command</b> Configure lacp port priority	<b>Format</b> lacp priority <0..65535> <b>Mode</b> Interface Config
<b>addport</b>	add one port to a LAG group	<b>Format</b> addport <LAG-ID> <b>Mode</b> Interface Config
<b>delport</b>	Remove a port from a LAG group	<b>Format</b> delport <LAG-ID> <b>Mode</b> Interface Config
<b>lldp</b>	An lldp agent can transmit information about the capabilities and current status of the system associated with its MSAP identifier. The lldp agent can also receive information about the capabilities and current status of the system associated with a remote MSAP identifier. However, lldp agents are not provided any means of soliciting information from other lldp agents via this protocol.	
	<b>1) lldp state set</b> Only transfer the lldp status	lldp state {tx   rx   tx_rx   disable} Interface Config
	<b>2) configure notifications</b> Enable/disable notification form the agent	lldp notification {enable disable} Interface Config
	<b>3) Configures which TLVs are enabled for transmission.</b>	
	<b>3.1) basic set</b>	<b>Format</b> lldp tlvs-tx {enable   disable} option basic {port-desc   sys-name   sys-desc   sys-capability } <b>Mode</b> Interface Config
	<b>3.2) 8021 set</b> Status of local-802.1 settings	<b>Format</b> lldp tlvs-tx {enable   disable} option 8021 {pvid   vlanname   protocol-id} Interface Config eg.switch(interdface 1)lldp tlvs enable option 8021 pvid 1
<b>3.3) 8023 set</b>	<b>Format</b> lldp tlvs-tx {enable   disable} option 8023 {mac-phy   power  link-aggregation  frame-size} <b>Mode</b> Interface Config	
<b>admin-mode</b>	Configure administrative mode on a port	<b>Format</b> Switch(Interface 1)# admin-mode {enable   disable} <b>Mode</b> Interface Config
<b>auto-negotiate</b>	Configure auto-negotiate mode on a port	<b>Format</b> auto-negotiate {enable   disable} <b>Mode</b> Interface Config

Commands	Description	Syntax
<b>speed</b>	Set port speed to 10Mbps half duplex/ 10Mbps full/ 100Mbps half/ 100Mbps full/ 1000Mbps 100FX mode/1000base-x full	speed {10hd   10fd   100hd   100fd   1000fd   100fx   1000base-x} Interface Config
<b>flow-control</b>	This command enable/disable flow-control on ports.	flow-control {enable   disable} Interface Config
<b>port-security</b>	This command add or delete a static mac into mac security table.	<b>Format</b> port-security {add delete} <sourcemac > <b>Mode</b> Interface Config
<b>port-security lock-mode</b>	This command disable port security or specify static lock mode.	port-security lock-mode {none   static} Interface Config
<b>port-security lock-mode dynamic</b>	This command enable limited dynamic lock mode,and specify maximin learning entries for limited dynamic lock mode.the max-entries value :0~24	port-security lock-mode dynamic max-entries 24 Interface Config
<b>qos</b>	This command specifies port-based qos priority mapping.	qos port-based priority <0..7> Interface Config
<b>rate-limit</b>	<b>1.1)rate-limit egress enable</b> This command limits egress rate, which the unit is Kbps.	<b>Format</b> rate-limit egress enable token bsize <Burst Size Value> <b>Mode</b> Interface Config
	<b>1.2)rate-limit egress disable</b> This command disable egress rate limit.	
	<b>2) rate-limit ingress</b> This command limits ingress rate, which the unit is Kbps.	<b>Format</b> rate-limit ingress <rate> <b>Mode</b> Interface Config
<b>storm-control</b>	<b>1) Enable/disable storm control.</b>	<b>Format</b> storm-control {enable   disable} <b>Mode</b> Interface Config
	<b>2) storm-control broadcast</b> This command storm control for broadcast only, and limited value :0,64,256,1024,10240,65536.102400,1024000,which the unit is Kbps and 0 means no limit.	storm-control broadcast <rate> Interface Config
	<b>3) storm-control broadcast-multicast</b> This command storm control limited value :0,64,256,1024,10240,65536.102400,1024000,which the unit is Kbps and 0 means no limit.	storm-control broadcast-multicast <rate> Interface Config
	<b>4) storm-control broadcast-unknown</b> This command storm control limited value :0,64,256,1024,10240,65536.102400,1024000,which the unit is Kbps and 0 means no limit.	<b>Format</b> storm-control broadcast-unknown <rate> <b>Mode</b> Interface Config e.g. Switch(Interface 1)# storm-control broadcast-unknown 64

Commands	Description	Syntax
	<b>5) storm-control all-cast</b> This command storm control limited value :0,64,256,1024,10240,65536.102400,1024000,which the unit is Kbps and 0 means no limit.	storm-control all-cast <rate> Interface Config
<b>rmon-counter</b>	This command specifies rmon counter capability on a port	rmon-counter {enable   disable} Interface Config
<b>set igmp-router-port</b>	This command specifies a igmp router port .	set igmp-router-port {enable   disable} Interface Config
<b>spanning tree</b>	<b>1) spanning-tree cost</b> This command configure RSTP port path cost, path cost value:0~200000000.	spanning-tree cost <pathcost> Interface Config
	<b>2) spanning-tree edge</b> This command configure edge property	<b>Format</b> spanning-tree edge {enable disable} <b>Mode</b> Interface Config e.g. Switch(Interface 1)# spanning-tree edge enable
	<b>3) spanning-tree force-p2plink</b> This command configure force point to point link mode.	spanning-tree force-p2plink {auto enable disable} Interface Config
	<b>4) spanning-tree migration-check</b> This command re-checks the appropriate BPDU format to send on this port	spanning-tree migration-check {enable disable} Interface Config
	<b>5) spanning-tree mst</b> This command configures multiple spanning tree instance.	
	<b>5.1) spanning-tree mst cost</b> This command configure the path cost on a MST instance :1~200000000.	spanning-tree mst cost <MST ID> <pathcost> Interface Config
	<b>5.2) spanning-tree mst priority</b> This command configure the port priority on a MST instance:0~4094.	spanning-tree mst priority <0~4094> <0~240> Interface Config
	<b>6) spanning-tree participation</b> This command configures RSTP capability on a port.	spanning-tree participation {enable disable} Interface Config
	<b>7) spanning-tree priority</b> this command configure RSTP port priority:0~240	spanning-tree priority <0..240> Interface Config
<b>vlan</b>	<b>1) vlan participation</b> This command join or leave a port to a vlan.	
	<b>1.1) vlan participation exclude</b> This command is used to leave a vlan.	vlan participation exclude < vlan id> Interface Config
	<b>1.2) vlan participation</b> This command join a vlan with untagged/tagged mode.	vlan participation {untagged  tagged}< vlan id> Interface Config
	<b>2) vlan protected</b> This command configures port protected property.	vlan protected {enable disable} Interface Config
	<b>3) vlan dropnq</b> This command configure port drop none 802.1Q frame .	vlan dropnq {enable disable} Interface Config

Commands	Description	Syntax
	<b>4) vlan pvid</b> This command configure port PVID.	<b>Format</b> vlan pvid <pvid> <b>Mode</b> Interface Config e.g. Switch(Interface 1)# vlan pvid 1
<b>Interface commands</b>	This command is used to change to another interface	<b>Format</b> Interface <port number> <b>Mode</b> Interface Config e.g. Switch(Interface 1)# interface g1

## 4. Specifications

### 4.1 Cable specifications

Straight Through and Crossover Cable Specifications Table

Ethernet Type	Cable Requirements	Maximum Length
10BASE-T	Category 3 or better, UTP or STP	328 ft (100M)
100BASE-TX	Category 5 or better, UTP or STP	328 ft (100M)
1000BASE-T	Category 5e or better, UTP or STP	328 ft (100M)



**Caution:** Please do not use telephone cables ; telephone cables do not support Ethernet or Gigabit .

Twisted-pair cabling comes in various grades, or categories. Category 5 is required for Fast Ethernet and is also the most reliable and most commonly used category. You can buy UTP Category 5 (Unshielded Twisted Pair) Ethernet cabling in precrimped lengths, or you can crimp your own. Crimping your own can result in faulty connections if the RJ-45 tips are not attached properly. Precrimped Category 5 cabling is available at most computer retail stores.

The most reliable and commonly used type of Category 5 cabling used is UTP, or "unshielded twisted pair." STP, or "shielded twisted pair" wiring is only necessary for network environments exposed to excessive amounts of electromagnetic interference, or EMI. These environments include areas with high sources of electrical power, air conditioning, generators, and radio signals. STP is also used for wiring outdoors.

There are two types of the wiring: straight through cable and crossover cable. Category 5 UTP/STP cable has eight wires inside the sheath. The wires form four pairs. Straight through cable has the same pinouts at both ends while crossover cable has a different pin arrangement at each end.

In a straight through cable, wires 1,2,3,4,5,6,7 and 8 at one end of the cable are still wires 1~8 at the other end. In a crossover cable, the wires of 1,2,3,6 are reversed so that wire 1 become 3 at the other end of the cable, 2 becomes 6, and so forth.

To determine which wire is wire 1, hold the RJ-45 cable tip with the spring clip facing towards the ground and the end pointing away from you. The copper wires exposed upwards to your view. The first wire on the far left is wire 1. You can also refer to the illustrations and charts of the internal wiring on the following page.

Figure 4-1 shows the diagram of Straight Through Cables  
 Figure 4-2 shows the diagram of Crossover Cables

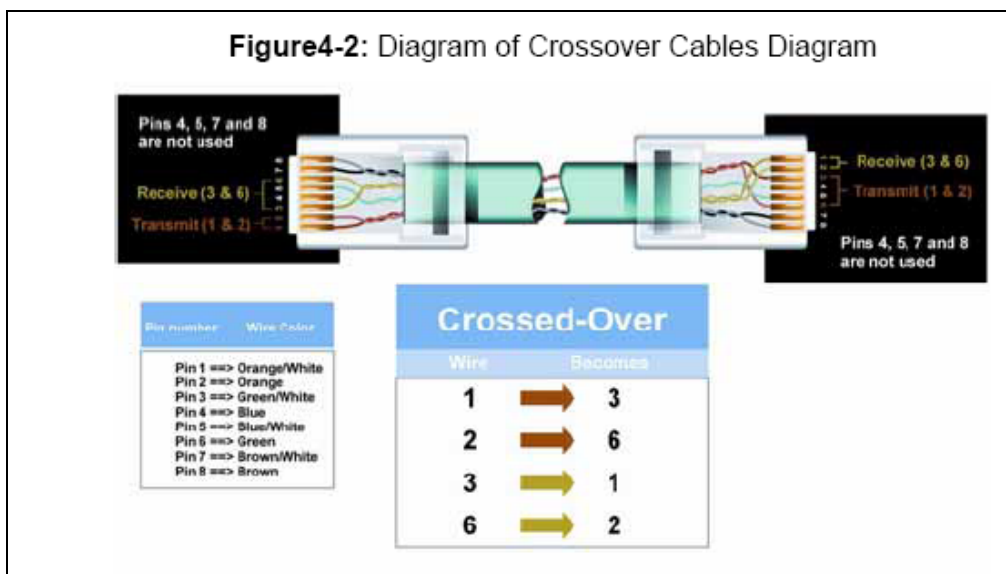
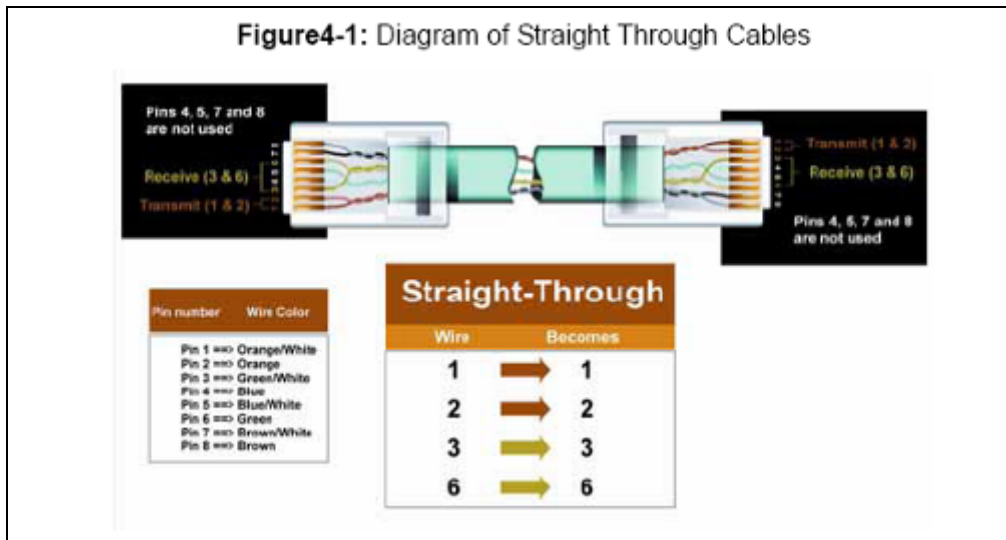

## 4.2 Technical specifications

<b>Standards</b>	IEEE802.3, IEEE802.3u, IEEE802.3ab, IEEE802.3z, IEEE802.3x, IEEE802.3ad, IEEE802.1q/p, IEEE802.1d, IEEE802.1w, IEEE802.1s, IEEE802.1x
<b>Buffer Memory</b>	32MB
<b>Mac Address Table</b>	8K entries
<b>Interface</b>	2 * Combo SFP/RJ-45 ports 24 * 10/100Mbps RJ-45 slots
<b>Bridging</b>	LACP (802.3ad), Tag-based VLAN (802.1q), Management Port-based VLAN, STP (802.1d), Rapid STP (802.1w), MSTP (802.1s), Port Mirror, Jumbo frame up to 9216K
<b>Multicast</b>	IGMP snooping, filtering and proxy, Broadcast Storm Control
<b>QoS</b>	Traffic classification, Port Priority, Bandwidth Control
<b>Security</b>	IEEE802.1x port-based authentication, Port security with MAC address, Access Control List, IP-MAC-Port Binding, DHCP Relay Agent(option 82)
<b>Management</b>	Web-based, Telnet, Console, SNMP, TFTP software-upgrade, Cabling Diagnostics
<b>SNMP &amp; MIBs</b>	SNMPv1,v2, v3, Interface MIB, Address Translation MIB, IP MIB, ICMP MIB, TCP MIB, UDP MIB, SNMP MIB, MIB-II, RMON MIB, Bridge MIB, Ethernet MIB, Enterprise MIB
<b>Environment</b>	Operating Temperature: 0° - 40° C Operating Humidity: 5% - 90%
<b>Dimension &amp; Weight</b>	430 x 250 x 44 mm, 2.8kg
<b>Power Supply</b>	100-240V AC, 50-60Hz
<b>Power Consumption</b>	30W
<b>Emission</b>	FCC Class A, CE



## 5 Warranty statement

We provide this limited warranty for it originally purchased the product from us or its authorized reseller or distributor. We guarantee that equipment is free from physical defects in workmanship and material under normal use from the date of original retail purchase of the Hardware. If the product proves defective during this warranty period, call our Customer Service in order to obtain a Return Authorization number. Be sure to have a proof of purchase on hand when calling. Return requests cannot be processed without proof of purchase. When returning a product, mark the Return Authorization Number clearly on the package pack and include you original proof of purchase. All customers outside the R.O.C shall be held responsible for shipping and handling charges.

In no event shall our liability exceed the price paid for the product from direct, incidental or consequential damage resulting from the use of the product, its accompanying software, or its documentation. We make no warranty or representation, expressed, implied, or statutory, with respect to its products or the contents or use of this documentation and all accompanying software, and specifically disclaim its quality, performance, merchantability, or fitness for any particular purpose. We reserve the right to revise or update its products, software, or documentation without obligation to notify any individual or entity.

The information in this guide may be changed without notice. The manufacturer assumes no responsibility for any errors which may appear in this guide.

Ethernet is a trademark of XEROX Corporation. Microsoft, Windows and Windows logo are trademarks of Microsoft Corporation.

Copyright 2010. All right are reserved. No Part of the contents of this guide maybe transmitted or reproduced in any form or by any means without the written permssion of us. Printed in Taiwan.

The revision date for this guide is **Dec., 2010**  
Version 1.0A

### **FCC Statement**

This product has been tested and found to comply with the limits for a Class A digital device pursuant to Part 15 of FCC Rules. These limits are designed to provide reasonable protection against such interference when operating in a commercial environment. This equipment generates uses and can radiate radio frequency energy, and if not installed and used according to the instructions, may cause harmful interference to radio communications.

Operation of this equipment in a residential area is likely to cause interference, in which case the user, at his or her own expense will be required to take whatever measures to correct the interference.

**CE Mark Warning**

This is a Class A product. In a domestic environment, this product may cause radio interference in which case the user may be required to take adequate measures.