

# AxW DC

## CONFIGURABLE MOTION CONTROL PLATFORM

User Manual 





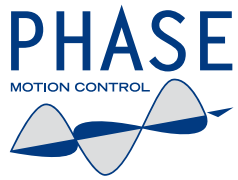

# AxW-DC

## CONFIGURABLE MOTION CONTROL PLATFORM

.....

User Manual 

Release 1.0

# SUMMI

## SUMMARY

---

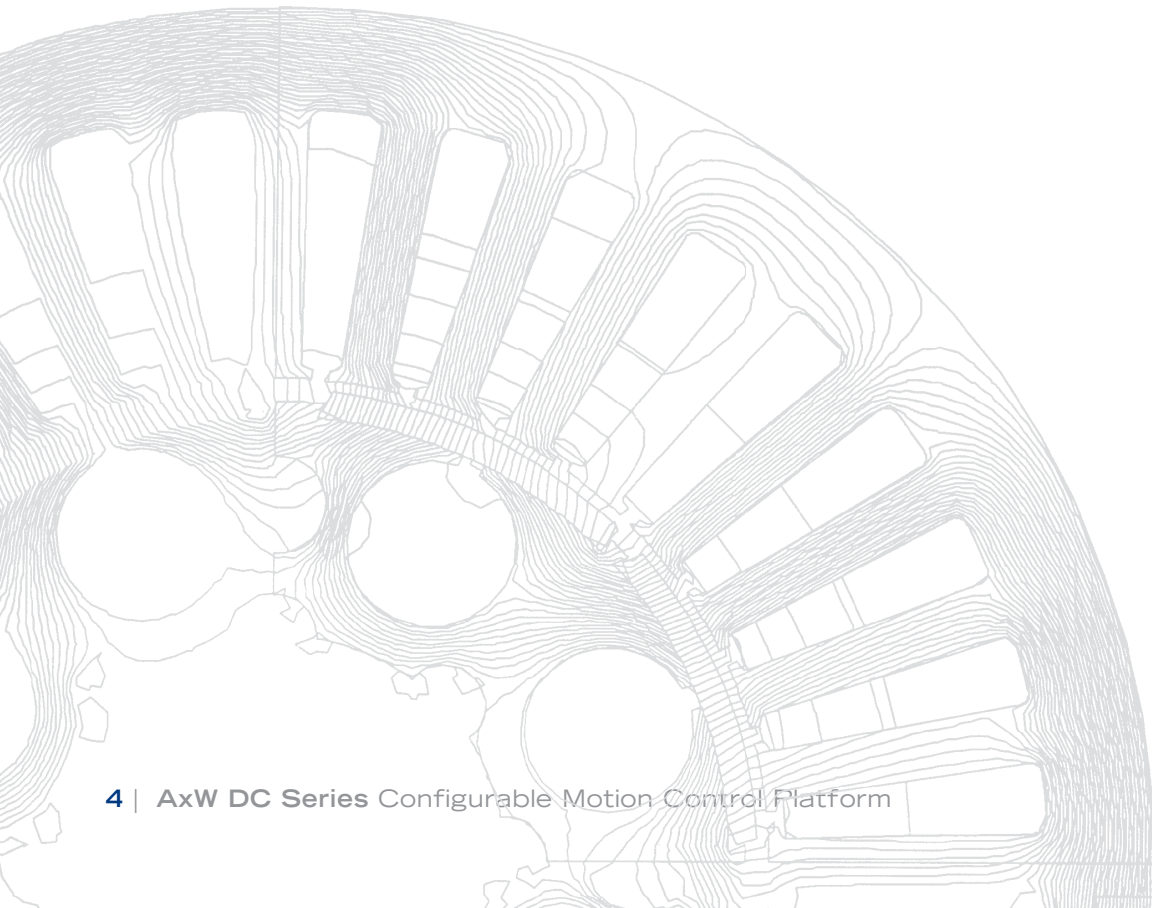

# SUMMARY

---

## 1 Mechanical Assembly and Wiring

- 1.1 Overall dimensions and space required for installation ..... 8
- 1.2 Mounting options..... 9

## 2 Drive Configuration

- 2.1 Communication set up and system configuration..... 14
- 2.2 Motor cabling and connection check-up

## 3 Electrical Connections

- 3.1 User Connectors (U1/U2)..... 18
- 3.2 Encoder Connectors (E1) ..... 19
- 3.3 CAN Connectors (C1) ..... 20
- 3.4 RS232 Serial Connectors (S1).... 21

## 4 Technical Specifications



# 1

## **MECHANICAL ASSEMBLY AND WIRING**

---

Phase Motion Control  
**AxM-II / AxP Configurable Motion Control Platform**

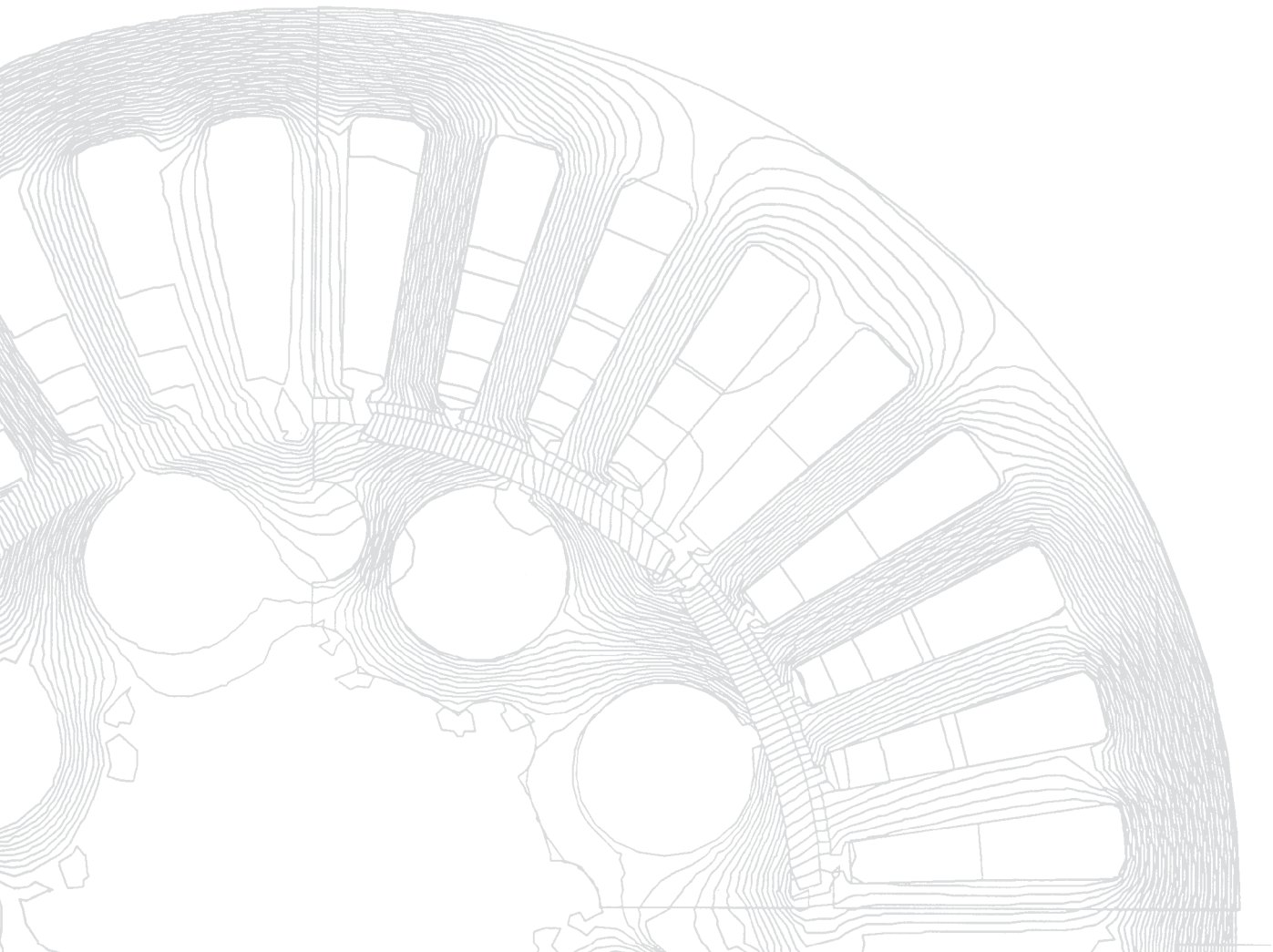

# 1.1 MECHANICAL ASSEMBLY AND WIRING

## AxW Overall dimensions

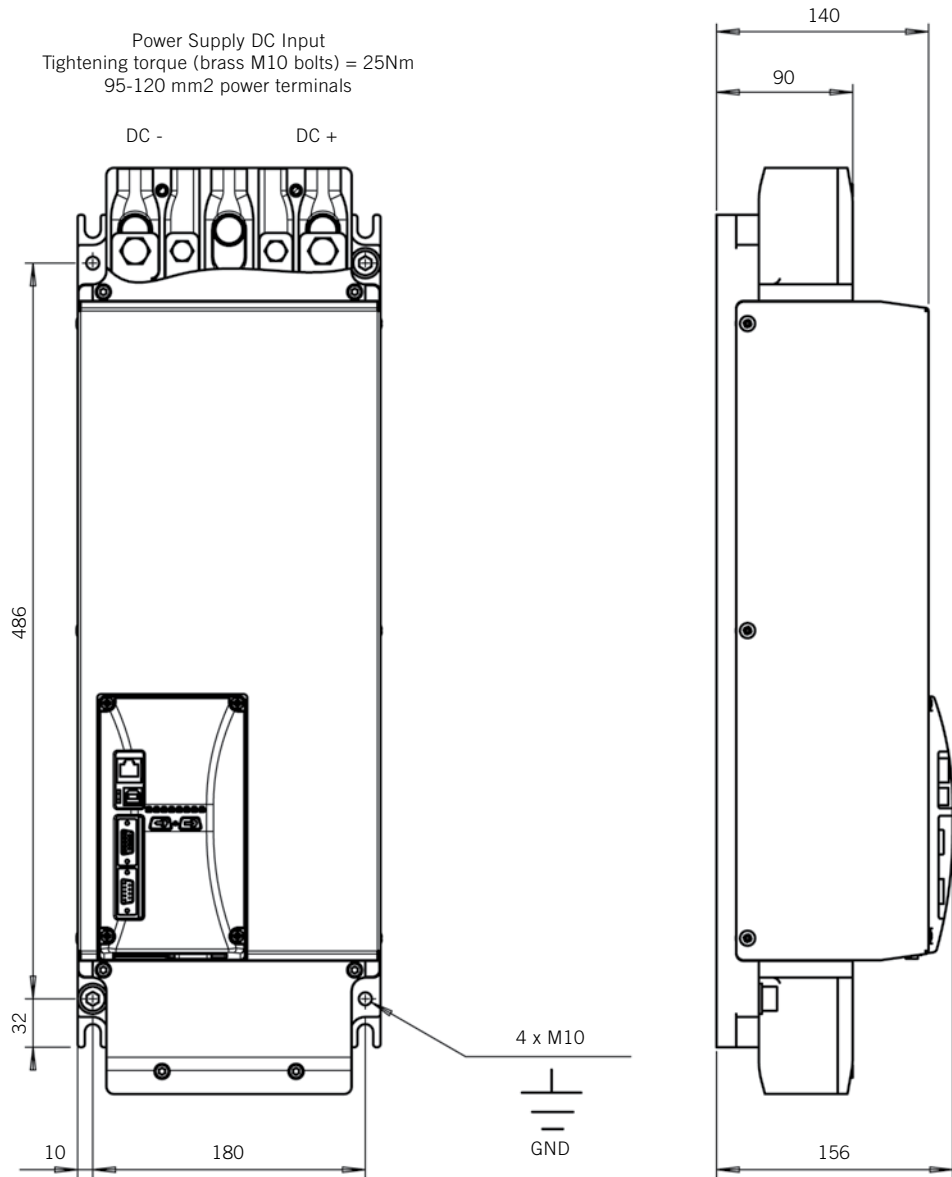



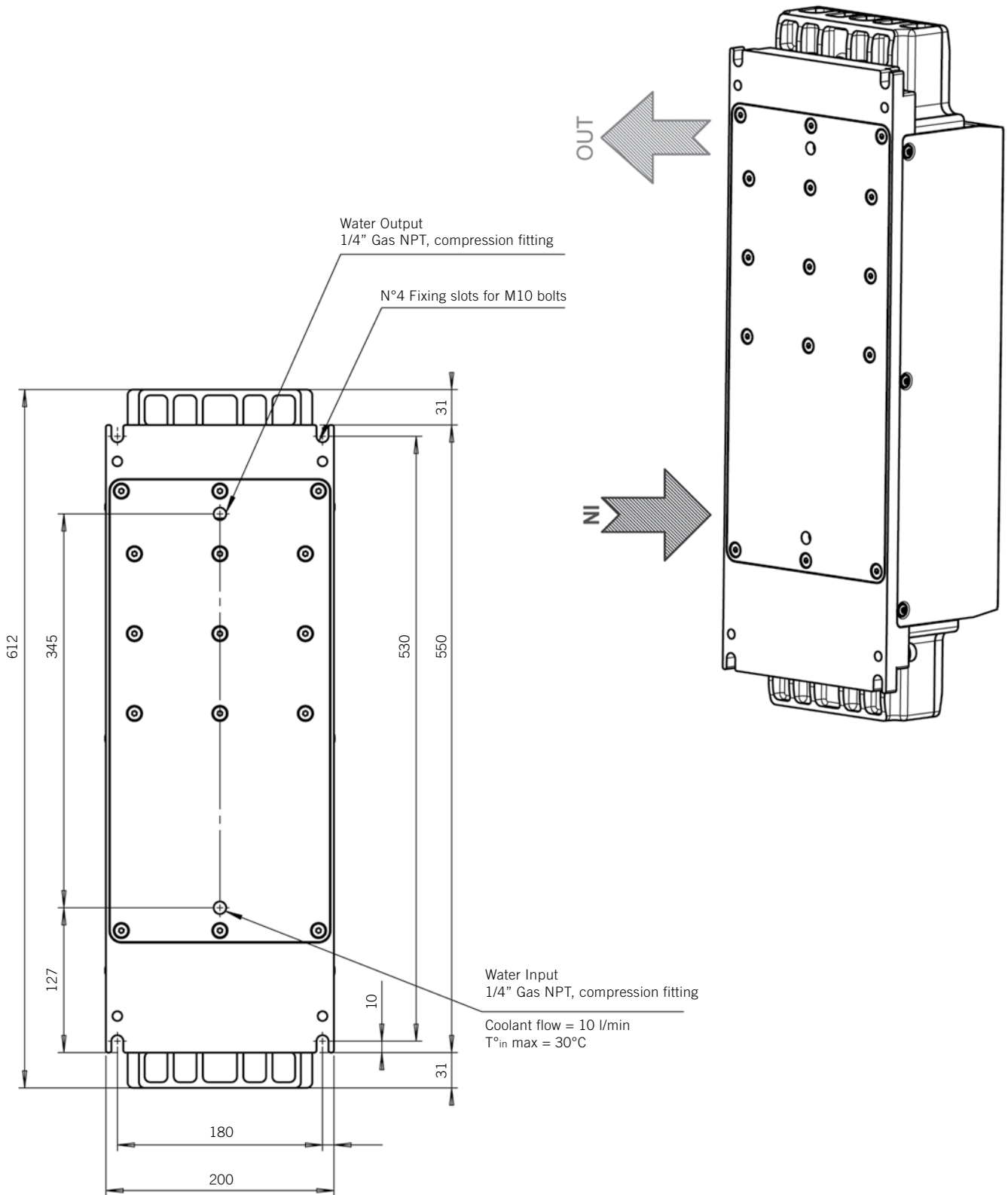

**Wiring**

Use Brass M10 bolts, 25Nm tightening torque with 95 / 120 mm<sup>2</sup> power terminals

**Cooling**

Use 1/4" Gas NPT compression fitting

## FxW Overall dimensions

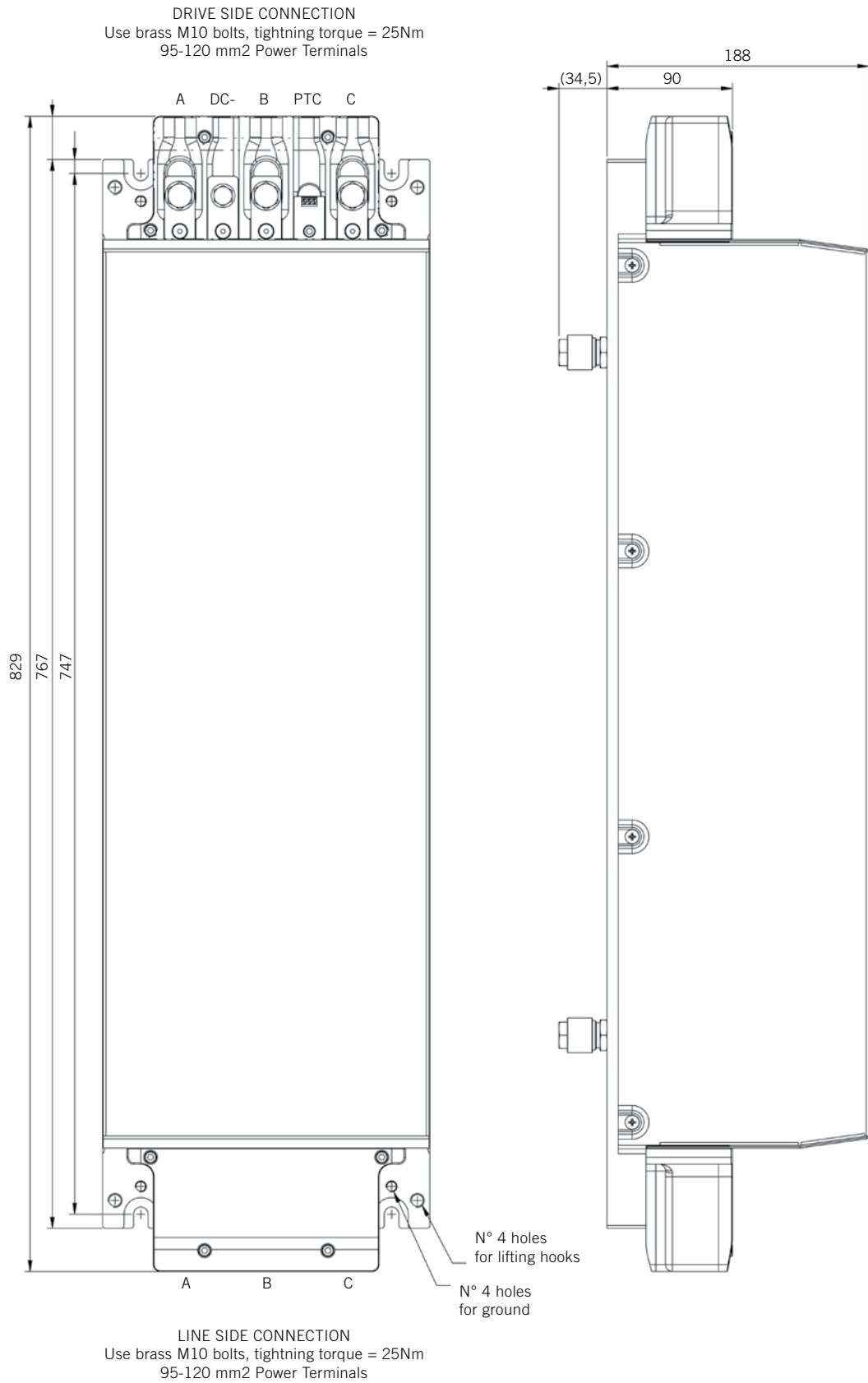

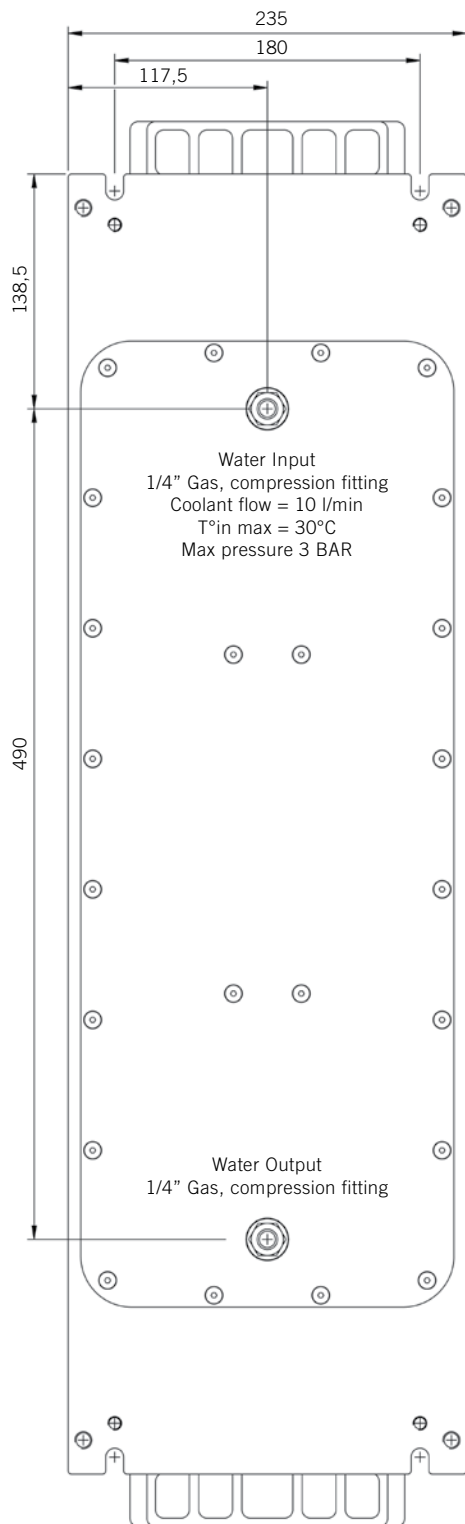



# 2

## DRIVE CONFIGURATION

---

Phase Motion Control  
**AxW DC Series Configurable Motion Control Platform**

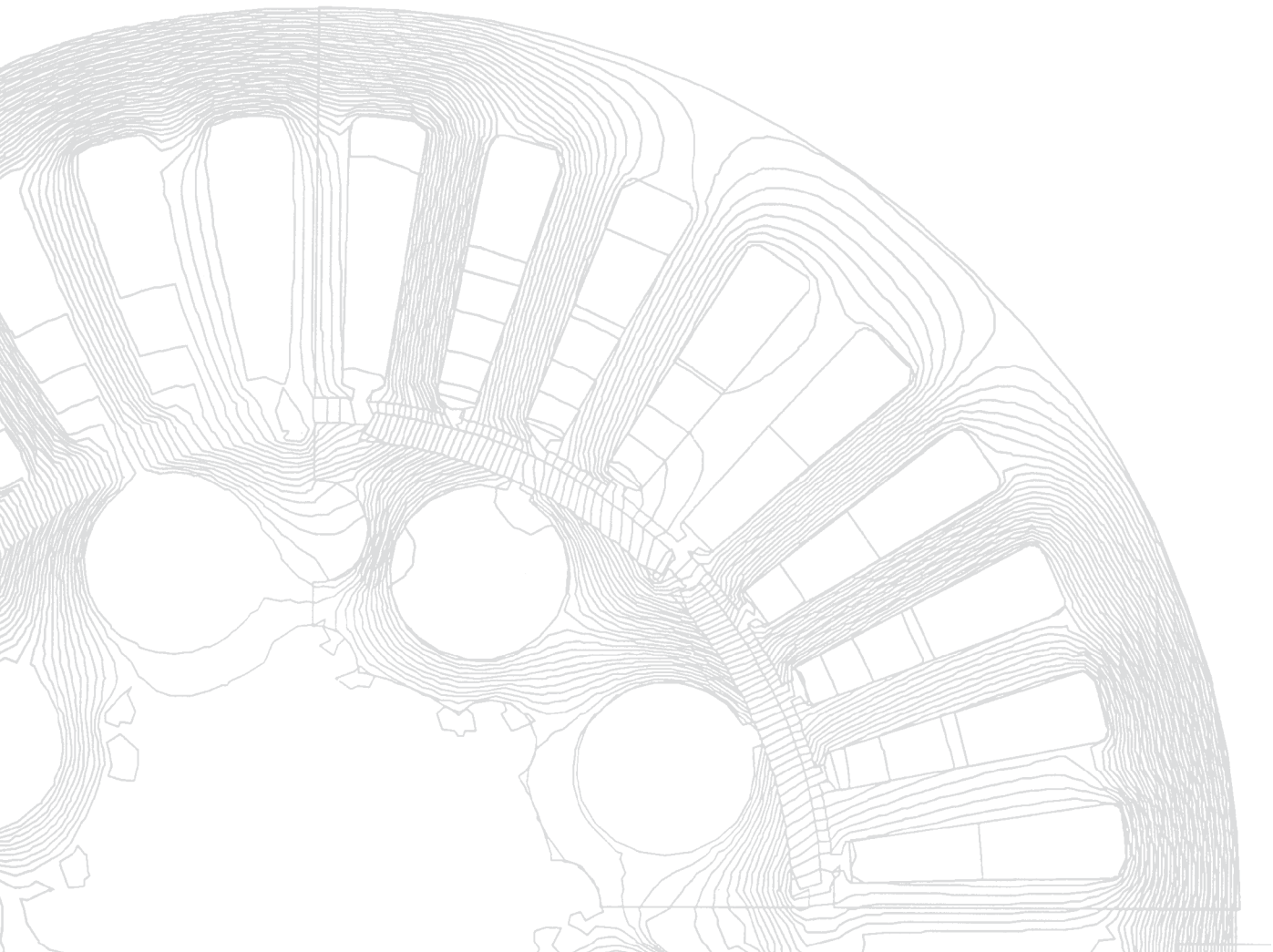

## 2.1 COMUNICATION SET UP AND SYSTEM CONFIGURATION

Configure your AxW according to your application request, upgrading (if necessary) the system application and the parameters settings.

“Cockpit” is the tool intended for this job.

Insert the CD-Rom supplied with the drive in the PC and let the autorun work. If it do not start please open the page “index.htm” in the CD root directory with any Internet browser. It is also possible activate setup opening the “setup.exe” file present in the folder

```
d:\ setup\axvsetup\disk1;
```

When setup is finished and PC restarted, the “AxV Cockpit” folder will be added to the Windows menu “Start->Windows Programs”

A PC with Windows XP, 80Mbyte of free space, Internet Explorer 6.0 browser or better and a RS 232 serial line is requested.

**Cable connection** is RS232 serial female to female, null modem (see pag. 10 for connections)

**Auxiliary power supply** 24V (22-30V) stabilized voltage 1A is necessary to supply the Drive.

### PC Connection Schema

- » connect 24V supply on “+24V” and “0V” pins of the U1 terminal box (see pag. 6 for connections schema).
- » Connect the RS 232 line to the connector S1 port

Switching on the 24V supply the drive will turn on and the configuration will become possible through “Cockpit” tool.

If no alarms are active the green led of the drive is blinking. Opening the system table SyaApp-X-x.par or the application table with Cockpit tool, the connection should be established automatically.

## 2.2 MOTOR CABLING AND CONNECTION CHECK-UP

### Encoder Connection

Connect the position sensor to **E1** port, through a suitable multipolar shielded cable, according to the relative correspondence specified in the wiring table of par. 3.2.

Use a shielded cable with twisted duplexes, possibly of high flexibility type.

When the connection cable is longer than 25 m, the use of adequate cable section is recommended in order to avoid excessive voltage drops.

**WARNING:**

The cable shield must be grounded both side connectin it to the motor ground screw and to the drive connector frame.

## Power connections

Connect the power supply to the DC+ and DC- input of the power terminal box. Connect the motor phases A, B, C and the Ground wire to the terminals of the drive's power terminal box, according to the sequence specified in the connection outline supplied with the motor.

A shielded cable must be used for motor phases connection and the cable shield must be grounded on both sides, motor and drive.

## User connection

On **U1** and **U2** terminal box there is the analog and digital drive interface, complete of:

- » 2 analog differential programmable inputs
- » 2 analog programmable outputs
- » 8 digital programmable inputs
- » 4 digital programmable outputs

Check par. 3.1 for complete conenction sets

## Field bus

On connector **C1** there is the CAN bus interface as specified on par. 3.3





# 3

## ELECTRICAL CONNECTIONS

---

Phase Motion Control  
**AxW DC Series Configurable Motion Control Platform**

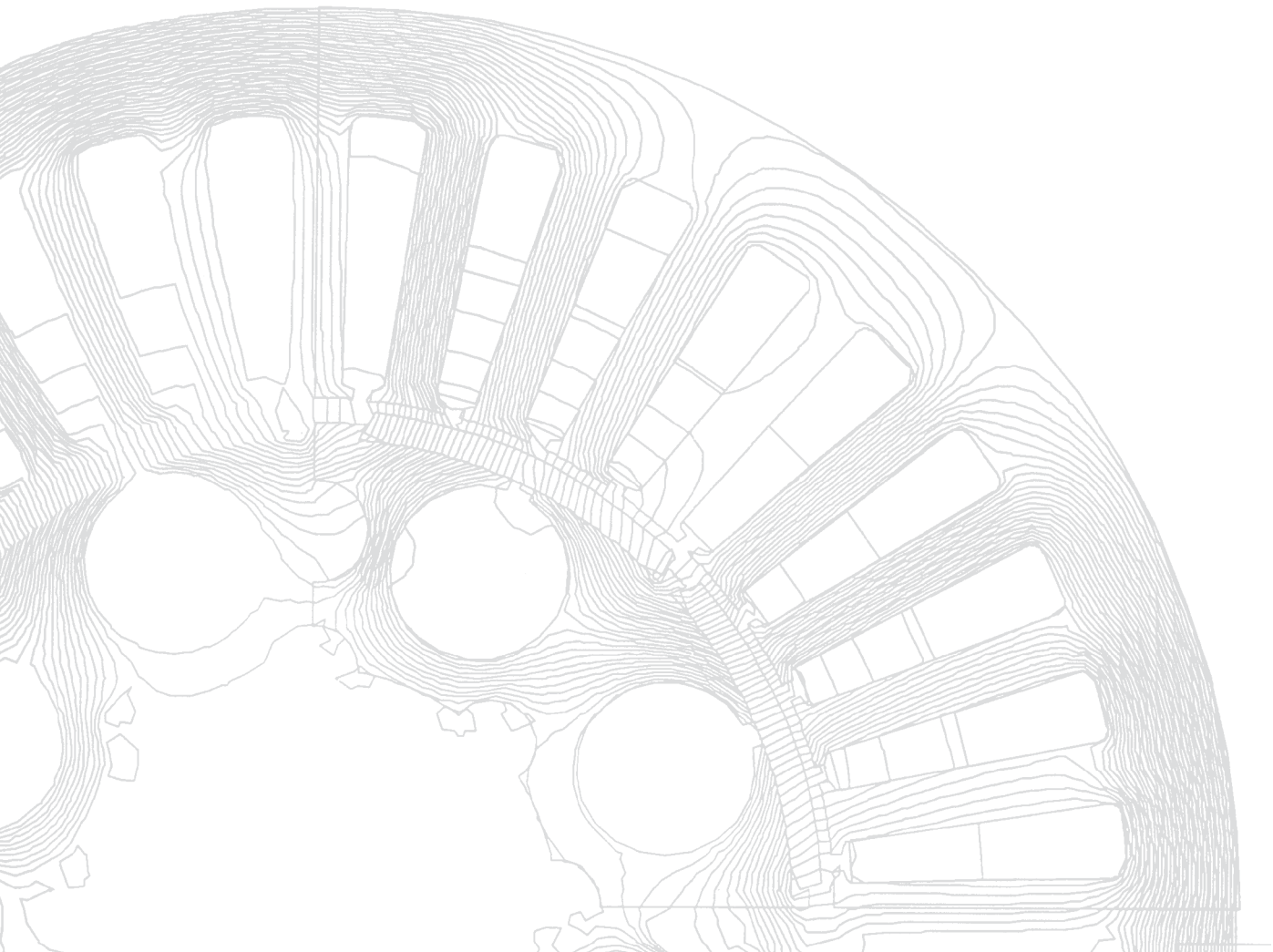

### 3.1 USER CONNECTORS (U1 /U2)

#### Removable Terminal Board, Phoenix 12 pin - cod. FK-MC 0.5/12-ST-2.5

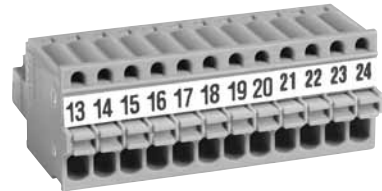

To obtain a good performance of the analog input connect the RxN pin to the reference (source side) and apply the  $-10/+10V$  to the RxP pin

USER CONNECTOR U1				
N	Name	Type	Function	Signal description
1	ROP	Analog input	Direct differential input	+/-10V, Z <sub>in</sub> = 10Kohm, if not used connect to GND
2	RON	Analog input	Denied differential input	+/-10V, Z <sub>in</sub> = 10Kohm, if not used connect to GND
3	A00	Analog output	Programmable output	+/-10V f.s., 5 mA
4	GND	Analog ground	Reference ground	Analog signals reference
5	DI0	Digital input	Programmable input	6.6 kOhm to ground, 20-30 V
6	DI1	Digital input	Programmable input	6.6 kOhm to ground, 20-30 V
7	DI2	Digital input	Programmable input	6.6 kOhm to ground, 20-30 V
8	DI3	Digital input	Programmable input	6.6 kOhm to ground, 20-30 V
9	DO0	Digital output	Programmable output	PNP open collector, 24 V, 100mA max
10	DO1	Digital output	Programmable output	PNP open collector, 24 V, 100mA max
11	24V	Auxiliary supply	Auxiliary supply of control circuits	Voltage: 22-30 V Referred to Pin 12 ( 0V) Requested current: 500mA.
12	0V	Auxiliary supply	Auxiliary supply negative	Digital signal reference

USER CONNECTOR U2				
N	Name	Type	Function	Signal description
13	GND	Analog ground	Reference ground	Analog signals Reference
14	R1P	Analog input	Direct differential input	+/-10V, Z <sub>in</sub> = 10Kohm, if not used, connect to GND
15	R1N	Analog input	Direct differential input	+/-10V, Z <sub>in</sub> = 10Kohm, if not used, connect to GND
16	A01	Analog output	Programmable output	+/-10V f.s., 5 mA
17	GND	Analog ground	Reference ground	Analog signals Reference
18	DI4	Digital input	Programmable input	6.6 kOhm to ground, 20-30 V
19	DI5	Digital input	Programmable input	6.6 kOhm to ground, 20-30 V
20	DI6	Digital input	Programmable input	6.6 kOhm to ground, 20-30 V
21	DI7	Digital input	Programmable input	6.6 kOhm to ground, 20-30 V
22	DO2	Digital output	Programmable output	PNP open collector, 24 V, 100mA max
23	DO3	Digital output	Programmable output	PNP open collector, 24 V, 100mA max
24	0V	Auxiliary supply	Auxiliary supply negative	Digital signal reference

## 3.2 ENCODER CONNECTOR (E1)

To allow the connection of different encoders some pins of this connector have more than one function. Select the connection corresponding to your encoder and set the parameters SYS\_ENC1\_TYPE and SYS\_ENC1\_CY\_REV in the system table (see par. 3.4)

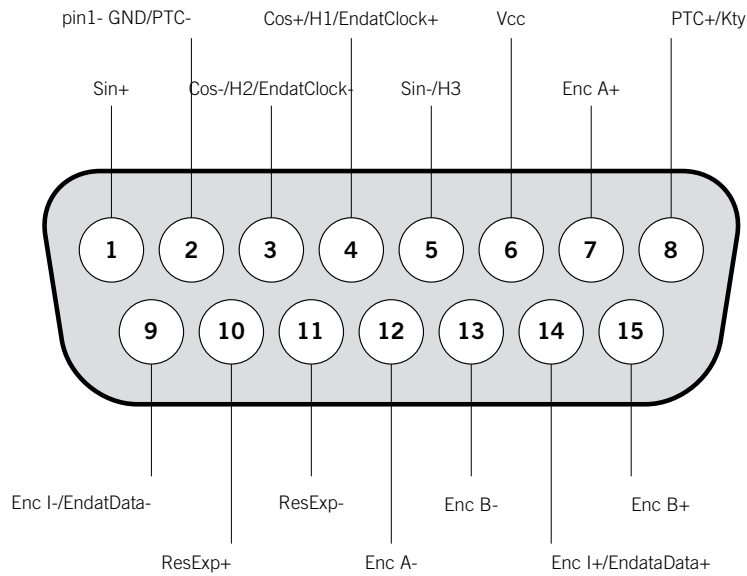

### Cannon connector subD 15 pin, male plug

#### Shield Connection:

To obtain a good connection without noise problems it is necessary to connect the shield of the encoder cable both on motor and drive side.

Motor side: connect the shield to the apposite screws or in the terminal board  
Drive side: connect the shield to the connector body.

### 3.3 CAN CONNECTOR (C1)

Connect the shield of the encoder cable to the connector body.

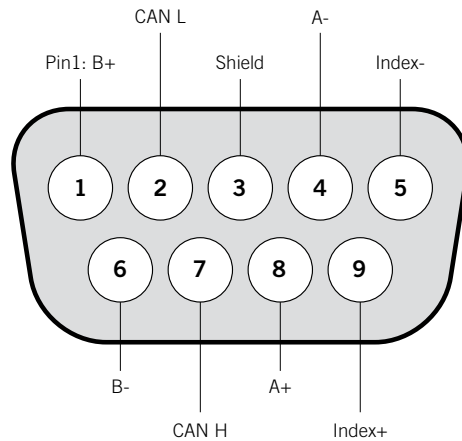

#### Cannon sub D9 pin, Male plug

C1 connector can be used alternatively for CAN line or to the auxiliary encoder signals; You can connect either the CANopen net or pick up the encoder emulation or use the inputs for auxiliary encoder.

The selection and the configuration is made by some system parameters.

Pin	Name	Type	Function	Signal description
1	B +	Digital I/O	Encoder incremental channel	TTL Differential line driver
2	CAN L	Digital I/O	CAN interface	CAN positive signal
3	Schermo	Gnd	CAN cable Shield	Logic Ground
4	A -	Digital I/O	Encoder incremental channel	TTL Differential line driver
6	B -	Digital I/O	Encoder incremental channel	TL Differential line driver
7	CAN H	Digital I/O	CAN interface	CAN negative signal
8	A +	Digital I/O	Encoder incremental channel	TL Differential line driver
9	I +	Digital I/O	Encoder index	TL Differential line driver

### 3.4 RS232 SERIAL CONNECTOR (S1)

#### Cannon connector sub D 9 pin, female plug

Standard RS 232 DCE ( + RS 485 )

Pin	Standard RS232	S1 connector	Description
1	DCD	---	
2	RxD	RxD ( Rx-, A )	Data Line
3	TxD	TxD ( Tx-, A )	Data Line
4	DTR	+12V	100mA MAX
5	GND	GND	
6	DSR	232 / 485	If +/-12V RS-232, if 0V RS-485
7	RTS	RTS ( Tx+, B )	Data Line
8	CTS	CTS ( Rx+, B )	Data Line
9	RI	---	





# 4

# TECHNICAL SPECIFICATIONS

---

Phase Motion Control  
**AxW DC Series Configurable Motion Control Platform**

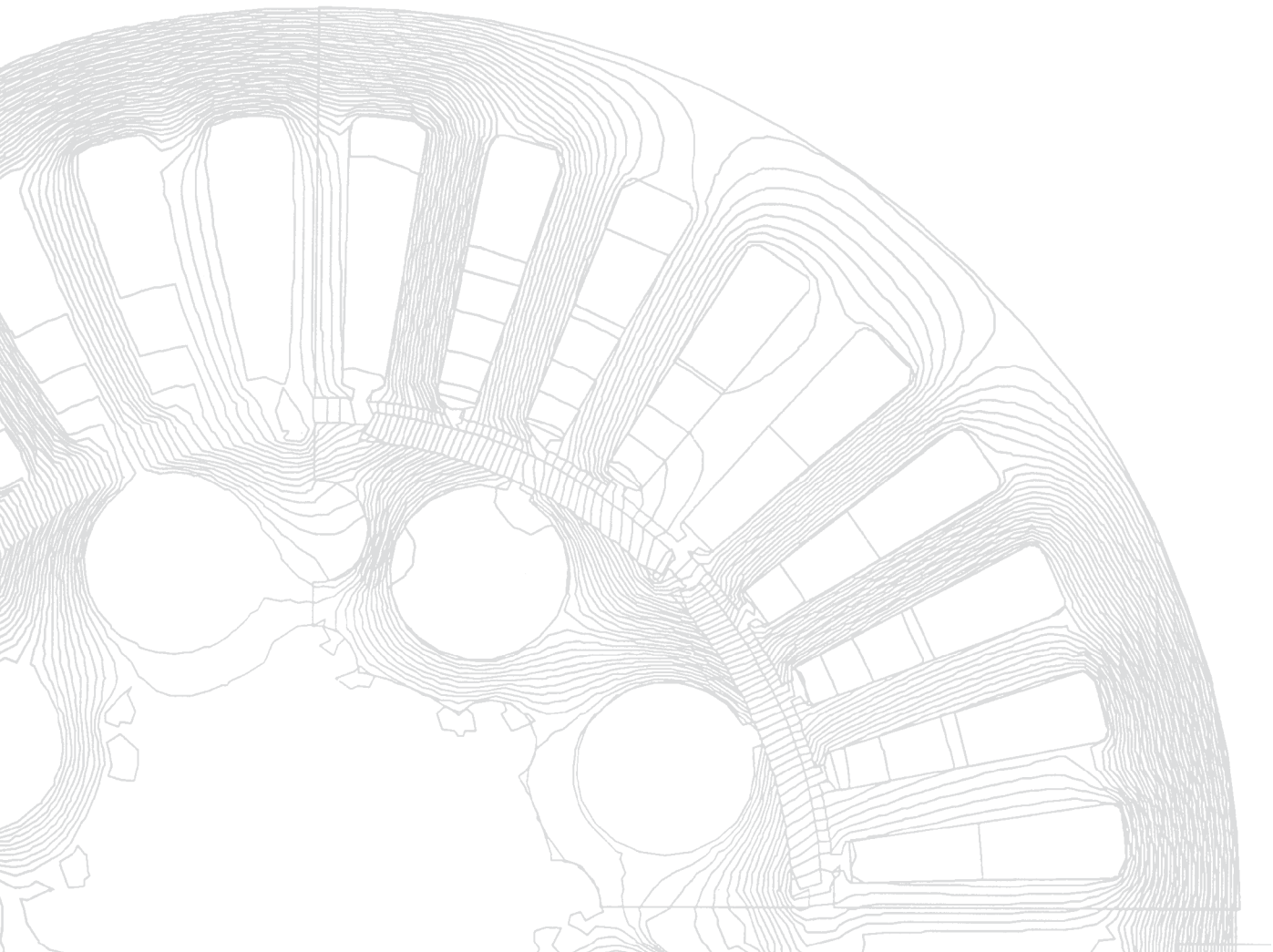

## 4.1 TECHNICAL SPECIFICATIONS

Test conditions, where not differently specified:  
VDC=700V, VAC=400V, cooling water temp. = 20°C

DC Side	AxW 250.330.6	AxW 300.400.6	Unit
Max DC Power	223	228	kW
Absolute MAX DC Voltage	950		Vdc
DC Voltage Range [VDC]	0 - 900		Vdc
Max DC Current [IDC]	245	297	Arms
Power Terminal Dimension	95 - 120		mm2

AC Side	AxW 250.330.6	AxW 300.400.6	Unit
Max AC Power	217	280	kW
MAX AC Voltage [VAC]	$(V_{dc} / \sqrt{2}) - 10\%$		
Max AC Current	330	400	Arms
Max AC Frequency	1,2		kHz
Ripple Current Frequency	16		kHz
Power Terminal Dimension	95 - 120		mm2

Performance	AxW 250.330.6	AxW 300.400.6	Unit
Efficiency	97,4 (*)		%
Water Cooling Temp. Range	18 - 60 (*!)		°C
Nominal Coolant Flow	10	15	l/min
Water In / Out Interface	1/4" Gas NPT		
Pressure Drop in Cooling Circuit	0.5		bar
Max Pressure in Cooling Circuit	5		bar
Environment Temperature	0 - 40		°C

(\*) – when the Drive is supplying 100KW of output power.

(\*!) CAUTION: Never overcool in order to avoid condensation; see Curves referred to  
Vac = 400V



**AxW 250.330.6**  
**Continuous Drive Current vs. Water Inlet Temperature**

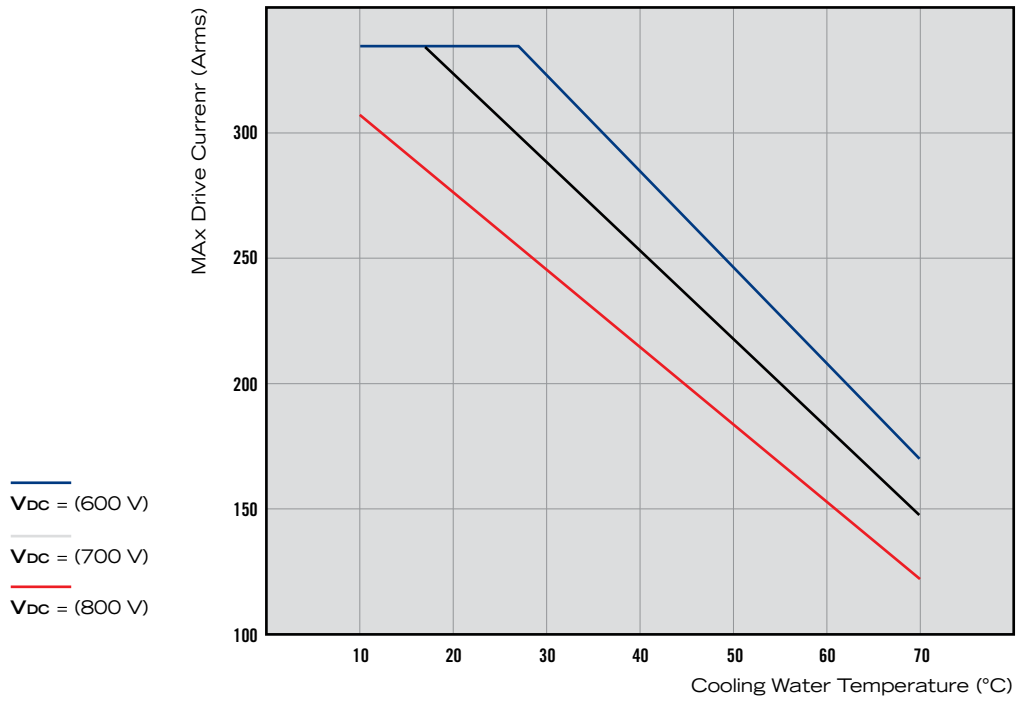

**AxW 300.400.6**  
**Continuous Drive Current vs. Water Inlet Temperature**

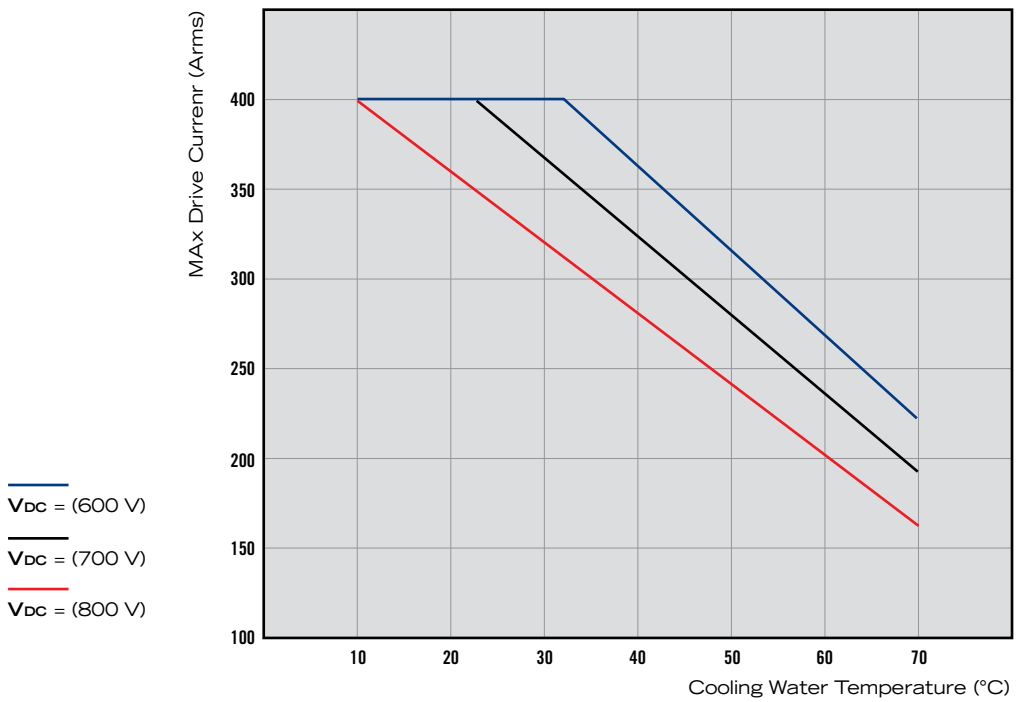

## Average Life Expectancy of Reactive Components vs. Current and Coolant Inlet Temperature

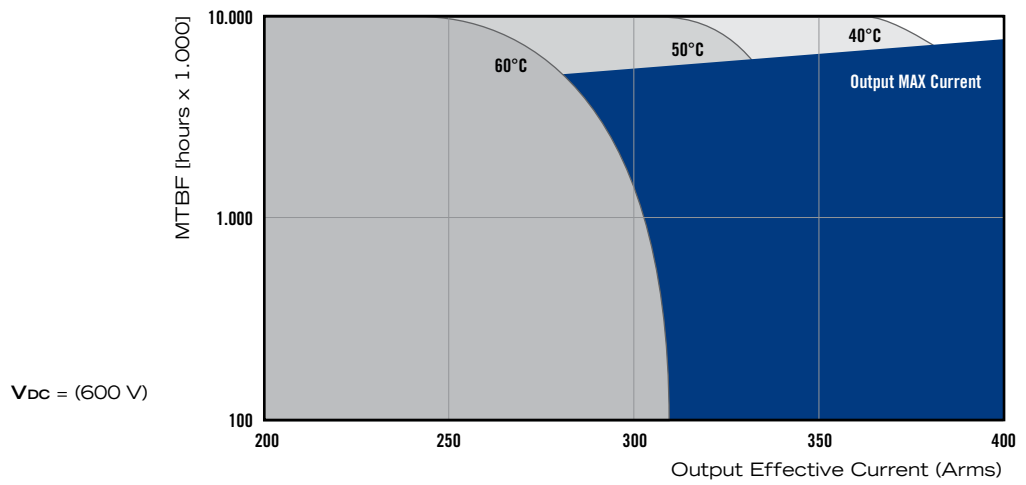
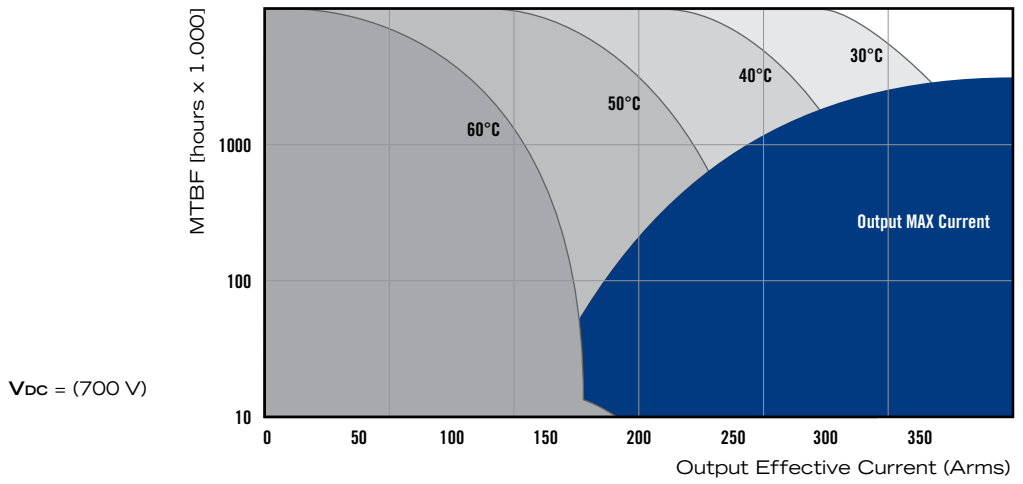
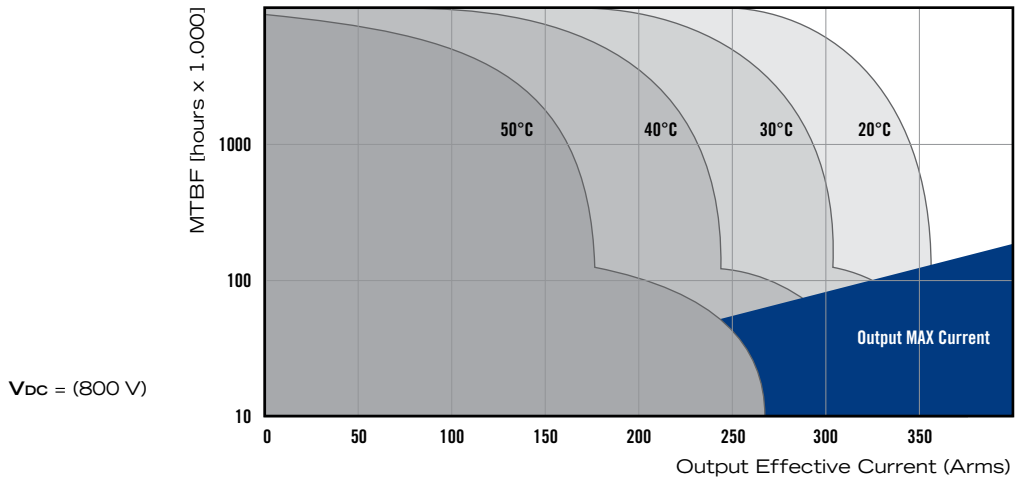

## AxW 250.330.6

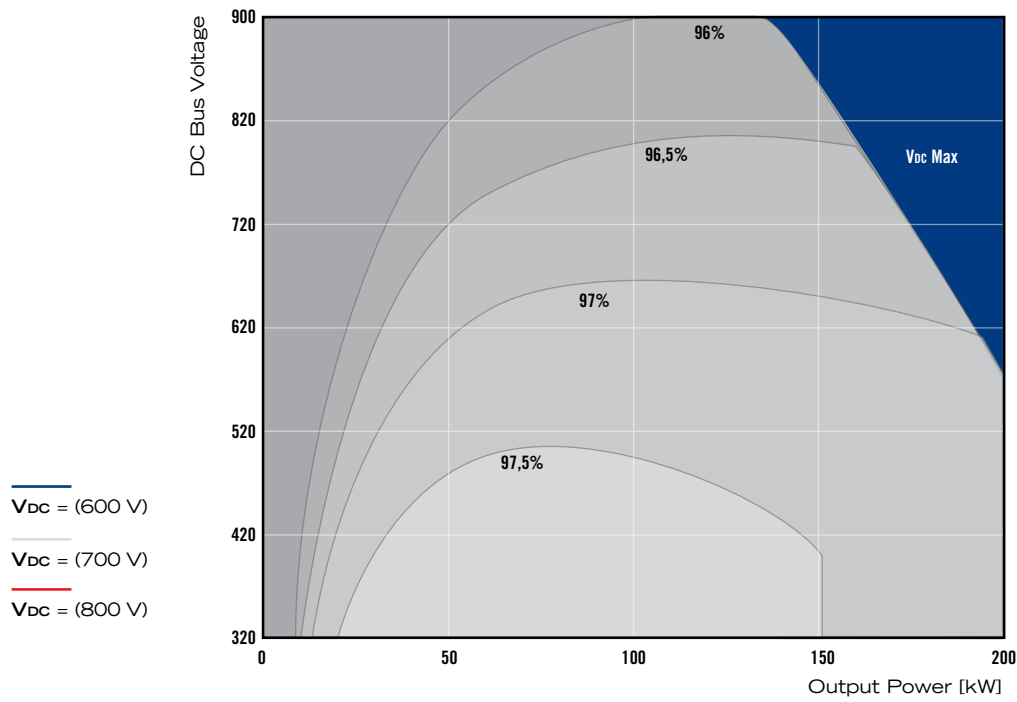

Converter efficiency loci Vs Output Power and DC link voltage (inclusive of FxW output filter loss).

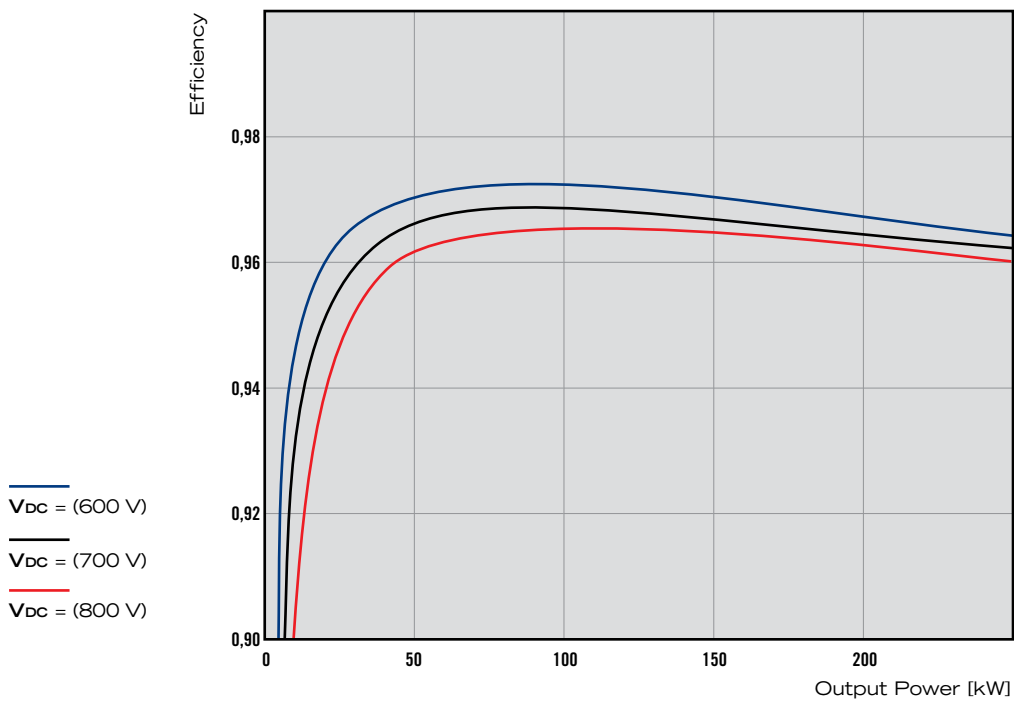

Efficiency Vs Output Power (inclusive of FxW output filter loss).

## AxW 300.400.6

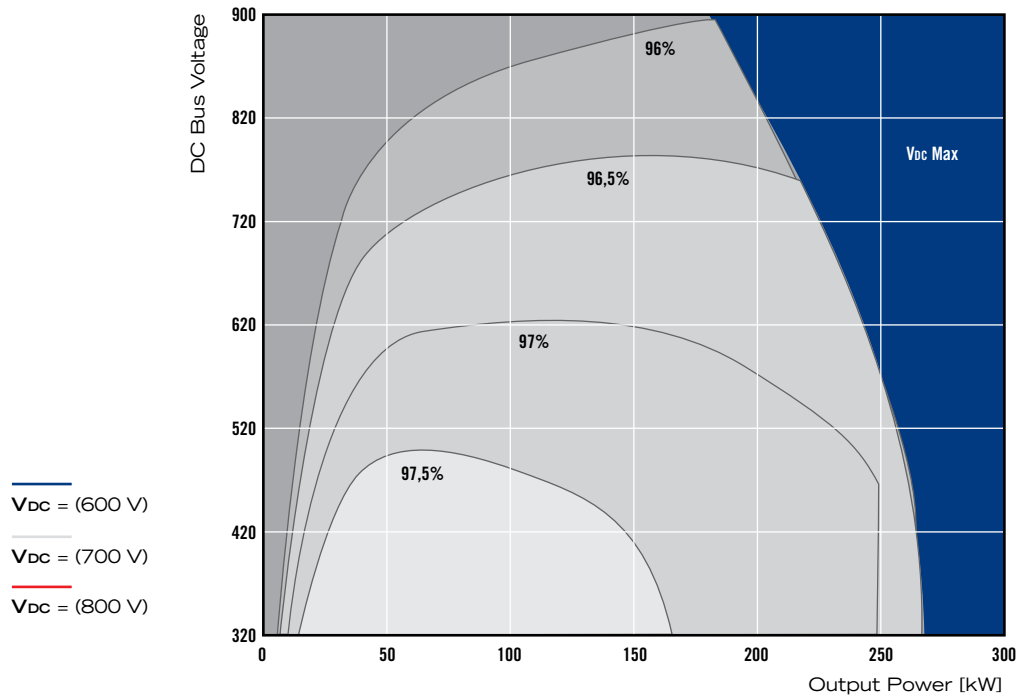

Converter efficiency loci Vs Output Power and DC link voltage (inclusive of FxW output filter loss).

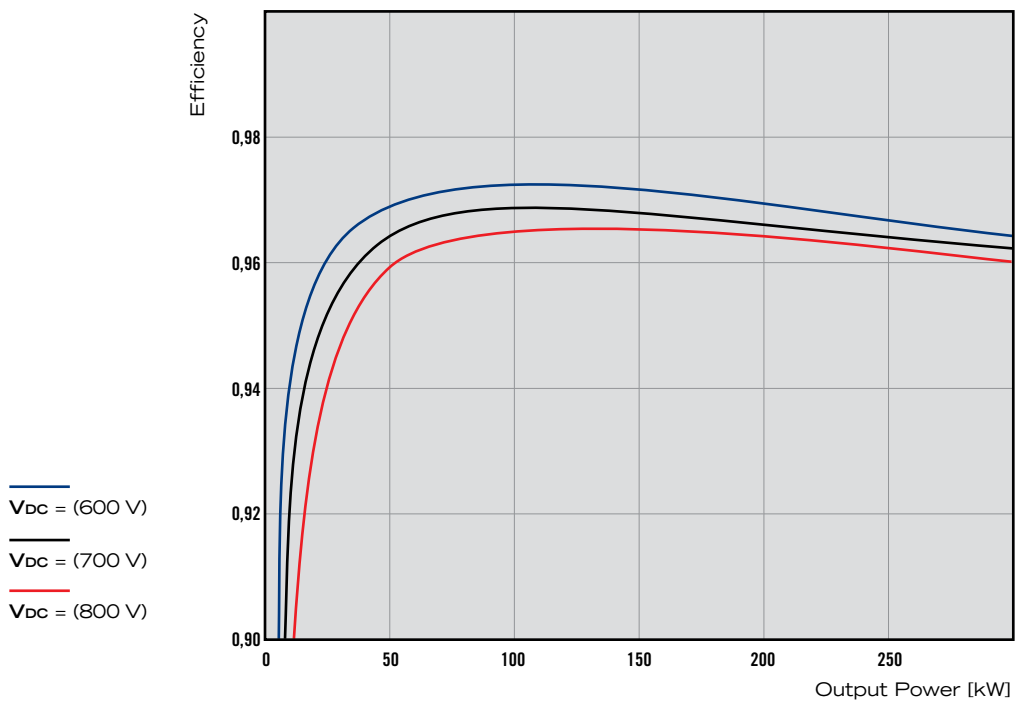

Efficiency Vs Output Power (inclusive of FxW output filter loss)



AxW-DC - Configurable Motion Control Platform  
User Manual  
English version  
Release 1.0



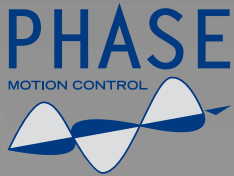

RETE MONDIALE DI DISTRIBUZIONE  
E ASSISTENZA  
**WORLDWIDE SUPPORT AND  
DISTRIBUTION NETWORK**

**Company headquarters**

Phase Motion Control S.p.a.  
Via Adamoli 461  
16141 Genova, Italy  
[www.phase.eu](http://www.phase.eu)

[www.phase.com.cn](http://www.phase.com.cn)

**Phase Automation (Ningbo) Ltd**

North of Binhai Rd  
Cixi Economic Development Zone  
Ningbo 315336  
[www.phase.com.cn](http://www.phase.com.cn)

**Phase Motion Control, China**

Phase Motion Control (Ningbo) Ltd  
55, Putuoshan Rd,  
Beilun Science and Technology Park  
Ningbo 315800

**Phase Motion Control, France**

Phase Automation S.a.r.l.  
20 Avenue Felix Faure  
69007 Lyon  
[www.phase-automation.com](http://www.phase-automation.com)

**Phase Motion Control, U.S.A.**

Phase USA, Inc.  
1335 Industrial dr.  
Itasca, IL 60143  
[www.PhaseUSA.com](http://www.PhaseUSA.com)

