

SPX-602H

User's Manual

Edition 1.0
2009/10/13



Copyright

Copyright 2009 all rights reserved. This document is copyrighted and all rights are reserved. The information in this document is subject to change without prior notice to make improvements to the products.

This document contains proprietary information and protected by copyright. No part of this document may be reproduced, copied, or translated in any form or any means without prior written permission of the manufacturer.

All trademarks and/or registered trademarks contains in this document are property of their respective owners.

Disclaimer

The company shall not be liable for any incidental or consequential damages resulting from the performance or use of this product.

The company does not issue a warranty of any kind, express or implied, including without limitation implied warranties of merchantability or fitness for a particular purpose.

The company has the right to revise the manual or include changes in the specifications of the product described within it at any time without notice and without obligation to notify any person of such revision or changes.

Trademark

All trademarks are the property of their respective holders.

Any questions please visit our website at <http://www.commell.com.tw>.

Packing List:

Hardware :

SPX-602H PCI-Express x1 Capture Card x1

Cable kit :

Video cable (Included)



16-Ch BNC video input Cable x 1
(OALDB25-BNC16)

Audio cable (Option)

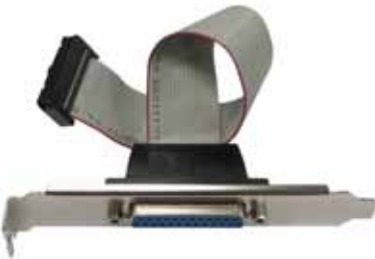

D-SUB 25 Cable x 1
(OAL1P-601H)



16-Ch RCA audio input Cable x 1
(OALDB25-AUD16)

CD Content : Windows Drivers/SDK & User's Manual

1.0 <Product Specification>

General Specification	
Form Factor	PCI-Express x1
Compression Format	H.264 Hardware compression technology
Video	Display Rate: NTSC:16-ch total 480 fps / D1 resolution PAL: 16-ch total 400 fps / D1 resolution Recording Rate: NTSC: 16-ch total 480 fps / D1 resolution PAL: 16-ch total 400 fps / D1 resolution
Audio	16-ch G.721 compression technology
TV-Output	SPOT & CALL Monitor
GPIO	16-bits GPIO interface (reserved)
OS Support	Windows XP , Vista (32-bit)
Software	Windows SDK Network Streaming SDK
Cable kit	1 x D-sub 25 to 16 channel BNC video Cable (OALDB25-BNC16) 1 x 20-pin header to 1 x D-sub 25 Cable (option) (OAL1P-601H) 1 x D-sub 25 to 16 channel RCA audio Cable (option) (OALDB25-AUD16)
Dimensions (L x W)	177.65mm x 111.15mm

1.1 <Component Placement>

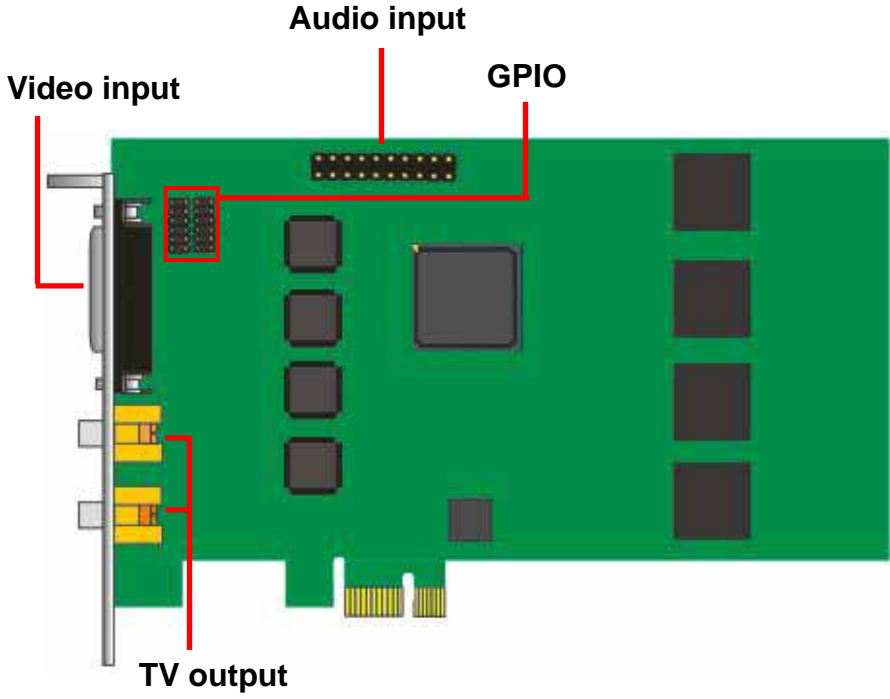

1.2 <Mechanical Drawing>

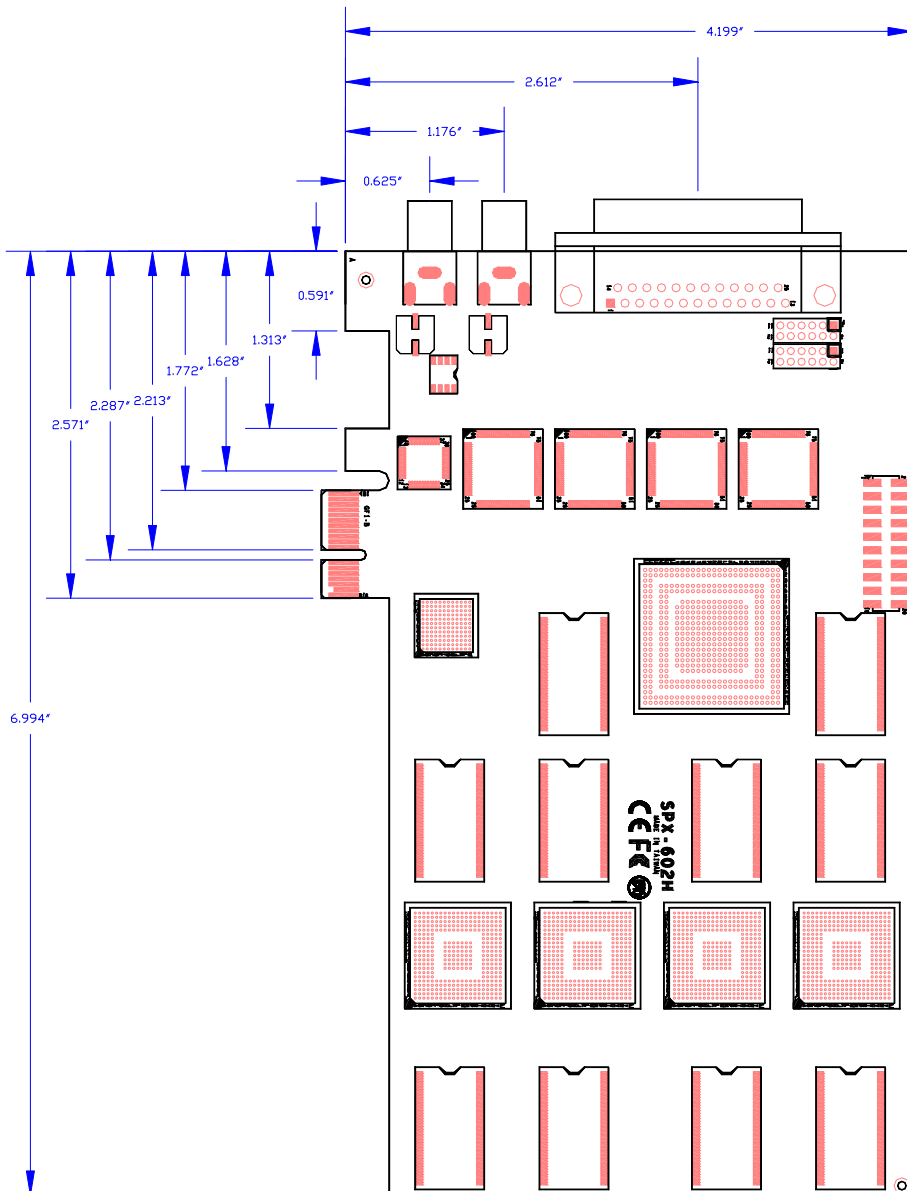

1.3 <Connector Reference>

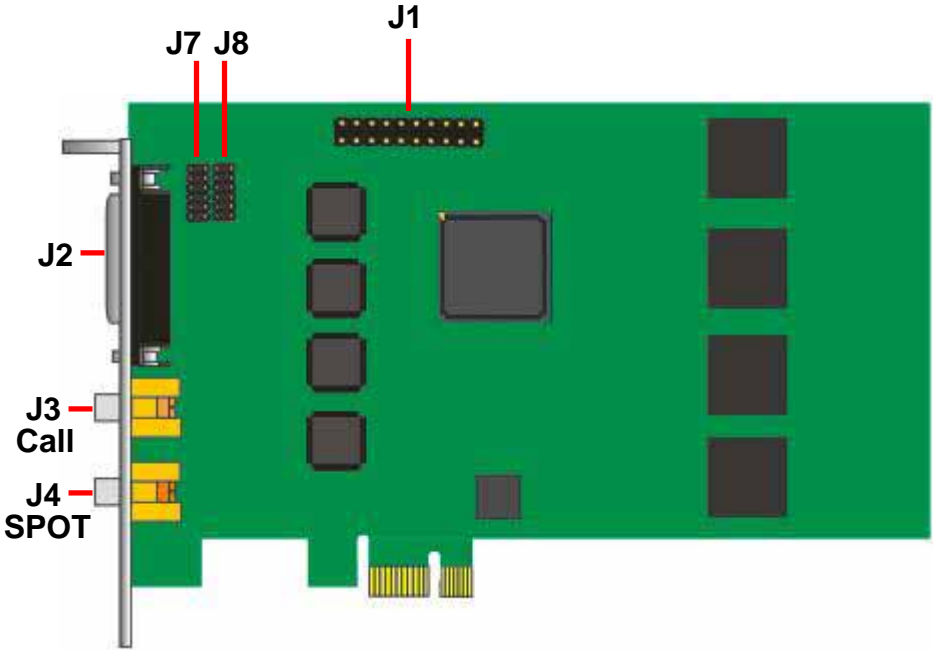

Connector: J1 (16 channel audio Input)
Type: 20-pin (10x2) header(2.54mm) X 1

Pin	Description	Pin	Description
1	Audio Input Ch 9	2	Audio Input Ch 1
3	Audio Input Ch 10	4	Audio Input Ch 2
5	Audio Input Ch 11	6	Audio Input Ch 3
7	Audio Input Ch 12	8	Audio Input Ch 4
9	Audio Input Ch 13	10	Audio Input Ch 5
11	Audio Input Ch 14	12	Audio Input Ch 6
13	Audio Input Ch 15	14	Audio Input Ch 7
15	Audio Input Ch 16	16	Audio Input Ch 8
17	GND	18	GND
19	GND	20	GND

Connector: J2 (16 channel video Input) D-sub25

Connector: J3 (Call Monitor) RCA

Connector: J4 (SPOT Monitor) RCA

Connector: J7 (8-bit GPIO) reserved

Type: 12-pin (6x2) header(2.0mm) X 1

Pin	Description	Pin	Description
1	GND	2	GND
3	GPIO0 PD11	4	GPIO4 PD15
5	GPIO1 PD12	6	GPIO5 PD16
7	GPIO2 PD13	8	GPIO6 PD17
9	GPIO3 PD14	10	GPIO7 PD18
11	+3.3V	12	+12V

Connector: J8 (8-bit GPIO) reserved

Type: 12-pin (6x2) header(2.0mm) X 1

Pin	Description	Pin	Description
1	GND	2	GND
3	GPIO8 PD19	4	GPIO12 PD23
5	GPIO9 PD20	6	GPIO13 PD24
7	GPIO10 PD21	8	GPIO14 PD25
9	GPIO11 PD22	10	GPIO15 PD26
11	+3.3V	12	+12V

1.4 <Driver Setting>

1. Copy the CD Driver folder to disk, Ex: C:\ , D:\ ...

2. Please choose **Device Manager**
then you can see **Other devices**
update driver **follow the device 0 to 3**

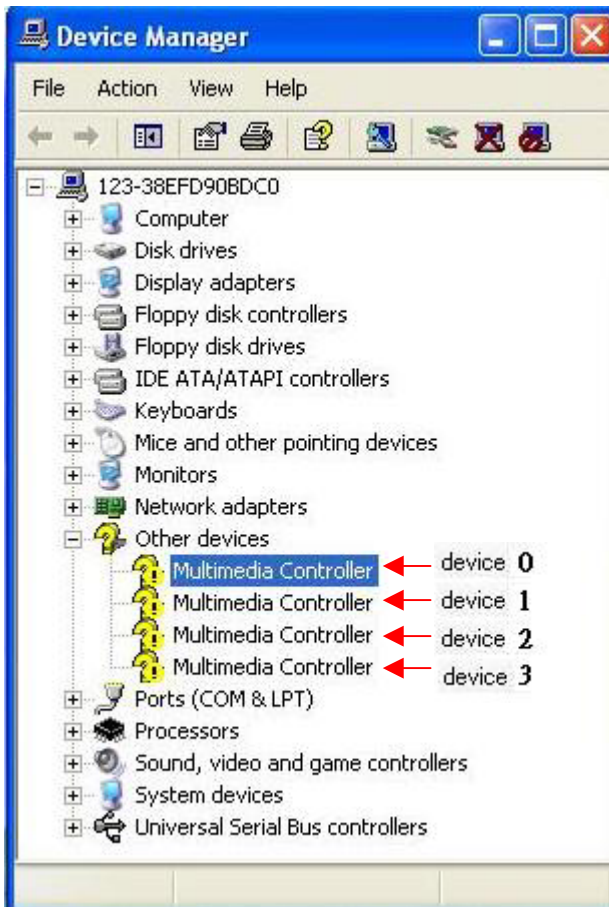

3. Please choose **Multimedia Controller** then press **advanced**



4. Please select file location

C:\SPX-602H_090907\driver

Hardware Update Wizard

Please choose your search and installation options.



Search for the best driver in these locations.
Use the check boxes below to limit or expand the default search, which includes local paths and removable media. The best driver found will be installed.

Search removable media (floppy, CD-ROM...)

Include this location in the search:

C:\SPX-602H_090907\driver

Don't search. I will choose the driver to install.
Choose this option to select the device driver from a list. Windows does not guarantee that the driver you choose will be the best match for your hardware.

5. Please press **continue anyway**

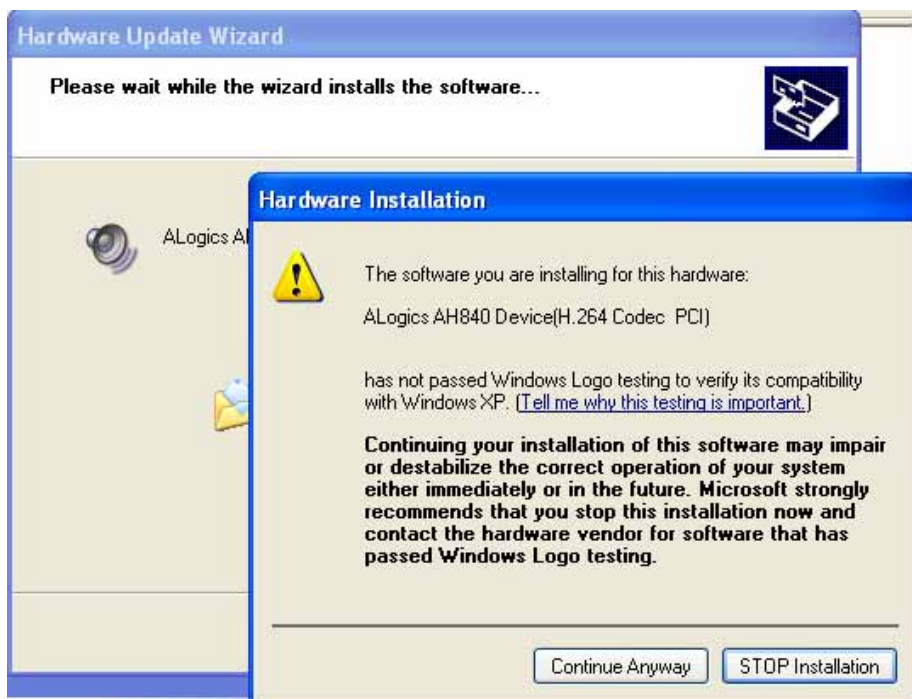

6. Press Finish

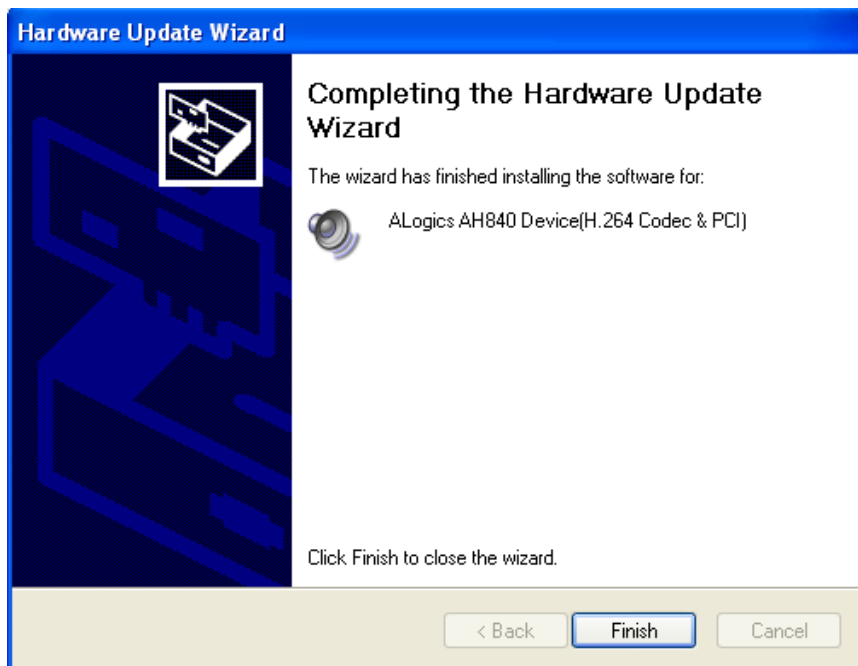

7. Driver install succeed

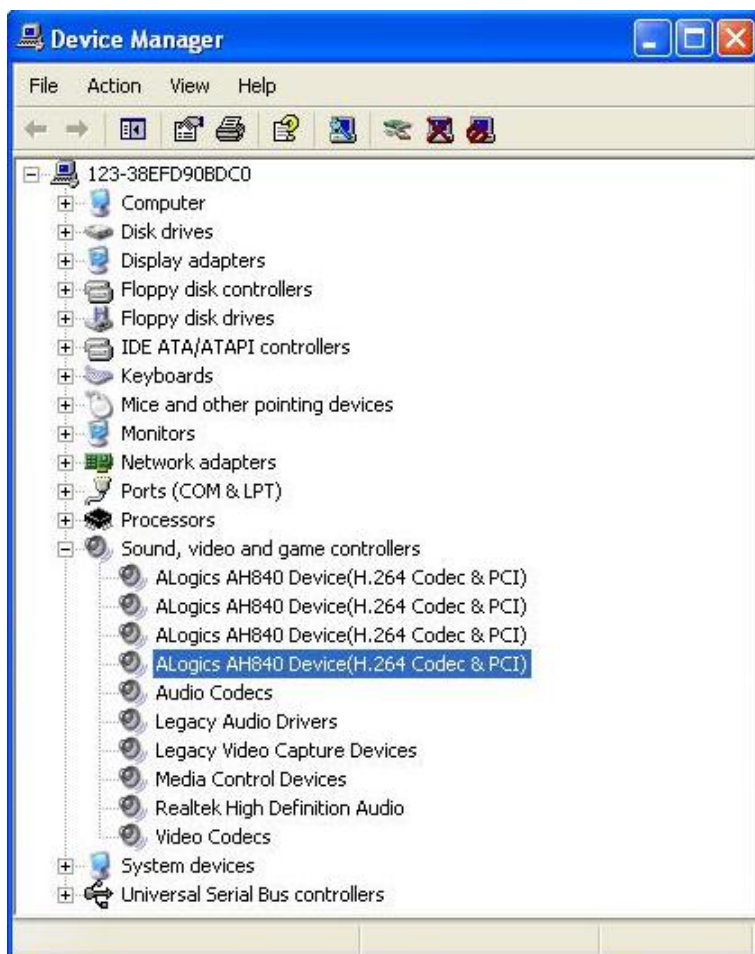

1.5 <Application files>

Location → C:\SPX-602H_090907\bin

AHWinApp.exe (Demo program)

AHWinPlayer.exe (Search program)

NetViewer.exe (Streaming program)

ALWatermark.exe (For checking watermark)

ALMonitor.exe (For check current compression rate)

ALCommon.dll (puplic library)

AZDevCtrl.dll (Driver interface library)

MyAVCD.dll (S/W Decoder library)

G721Codec.dll (Voice codec library)

WatermarkDLL.dll (Watermark library)

1.6 <Demo program play>

- 1) The Program is composed by Application program and Player (AHWinPlayer.exe).
- 2) If the application program was activated, it will be come out below window in the screen (FYI, Default camera input is set by NTSC).

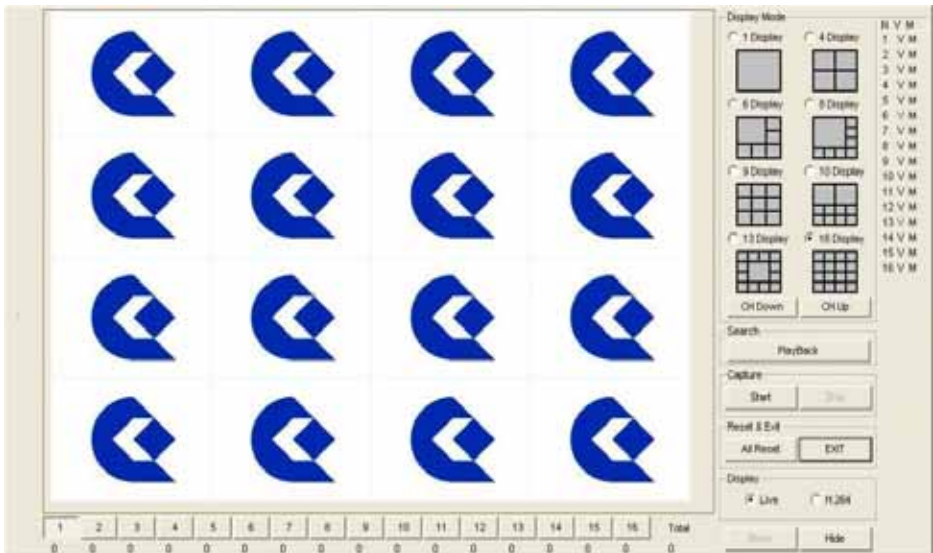

- 3) If the program is activated, 16ch display screen will be come out as a default.
- 4) The right part of display is composed of Display mode, Reset & Exit, Display set block.
- 5) The below [1]~[16] button of Display is for channel choice.
- 6) The below number of channel choice button means frame per second of each channel compressed and if the capture start, put a mark frame number which is captured.
- 7) The Show, Hide block in the right-below part could activate or disable detailed setting dialogs.

1.6.1 <Display Mode>

- 1) The screen displayed is controlled by Display Mode.
- 2) If it choose [1 Display], it comes out 720x480 size for just one channel in display screen and in this time, the channel could be changed by pressing [CH Down], [CH Up] button and also choose channel by pressing [1]~[16] button.
- 3) [4 Display], [6 Display], [8 Display], [9 Display], [10 Display], [13 Display], [16 Display] could choose the channel in the same way.

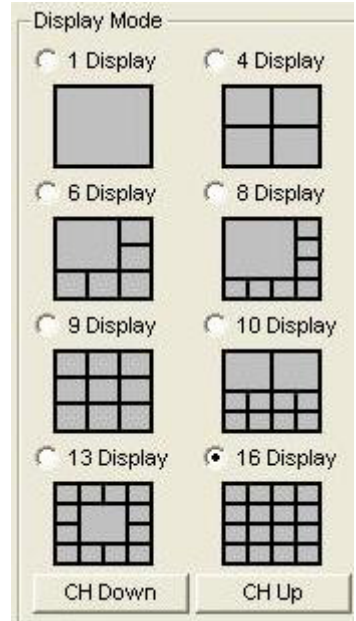

1.6.2 <Search>



- 1) This button to playback the record file

1.6.3 <Capture>

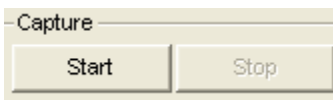

- 1) There are two [Start] and [Stop] buttons.
- 2) If choose [Start] button, the live and capture image is displayed.
- 3) If choose [Stop] button, the live and capture image stops.

1.6.4 <Reset & EXIT>

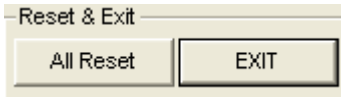

- 1) There are two [All Reset], [EXIT] buttons.
- 2) If [All Reset] button press, the value in PC Card is initialized in PC Card.
- 3) If [EXIT] button press, Application program is finished.

1.6.5 <Display>

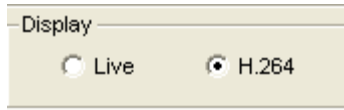

- 1) It could choose [Live] or [H.264] in Display setting block.
- 2) If you choose [Live] in capturing status, the chosen channel's live image is displayed in the screen in the real time.
- 3) If you choose [H.264] in capture start status, you could watch law capture image.

1.6.6 <Capture Information>

- 1) You could see camera off and motion event status in the right part of program window.
- 2) On the occasion of not having camera input, it will be displayed the red color "V" letter.
- 3) On the occasion of working motion event, it will be displayed the red color "M" letter.

N	V	M
1	✓	M
2	✓	M
3	✓	M
4	✓	M
5	✓	M
6	✓	M
7	✓	M
8	✓	M
9	✓	M
10	✓	M
11	✓	M
12	✓	M
13	✓	M
14	✓	M
15	✓	M
16	✓	M

1.6.7<Menu expansion>



- 1) There are two [Show] and [Hide] buttons.
- 2) If you press [Show] button, Menu expansion which could set application program in detail is displayed under main screen.
- 3) [Hide] is used for hiding this expansion-menu.

1.7 <Demo program menu expansion>

1.7.1 <General>



- 1) There are [General], [Camera], [Codec], [Register], [Color], [OSD], [Motion], [Audio], [Spot], [Network] tap in expansion-menu.
- 2) You could NTSC and PAL in [General] tap.
- 2) Default is NTSC, if you want change from NTSC to PAL, choose [PAL-B] and press [All Reset] button.
- 3) You could choose Hard disk drive in [Save Drive]. Default is C Drive.

1.7.2 <Camera>

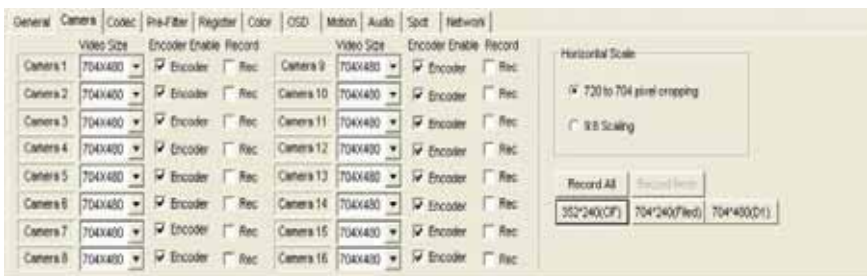

- 1) [Camera] : You can check the tab-settings through Rec in [Display] of main screen. User can use this image when the user does Network transmit.
- 2) Each channel could set the resolution.
- 3) All channel is set 720x480 (D1) resolution as a default. (NTSC).

1.7.3 <Codec>

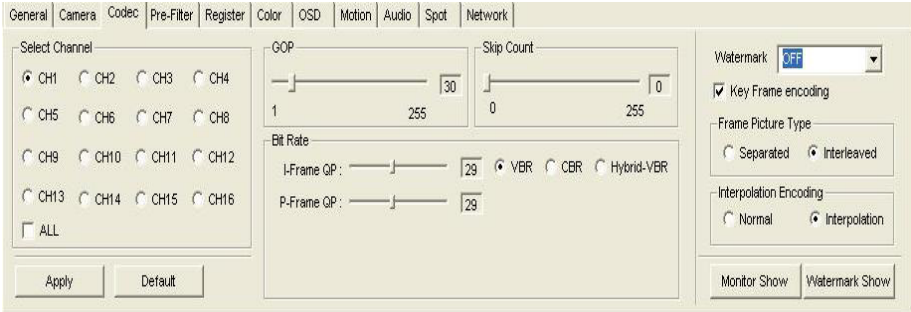

- 1) It choose Encoding Path.
- 2) [GOP] : could control the number of group of I frame and P frame.
- 3) [Skip Count] : could control the number of frame per second of chosen channel.
- 4) [Bit Rate] : set the display quality of chosen channel.
 - set VBR, CBR or Hybrid-VBR
 - I-Frame QP : set the display quality value of I Frame.
 - P-Frame QP : set the display quality value of P Frame.
 - QP-Limit, BPS Limit : set display quality limited value when it set CPR.
- 5) [Watermark] : recognition of On/Off water mark of chosen channel and choose the level.
- 6) [Frame Picture Type] :set field resolution of Odd, Even of D1 image.
On the occasion of Separated, it is displayed Even Field in upper side, Odd Field in below side.
- 7) [Key Frame Encoding] : set whether or not use of Key Frame of chosen channel.
- 8) [Interpolation Encoding] : set function to be shorten color line when H.264 compress, the color information is changed from 4:2:2 to 4:2:0

1.7.3 < Pre-Filter >

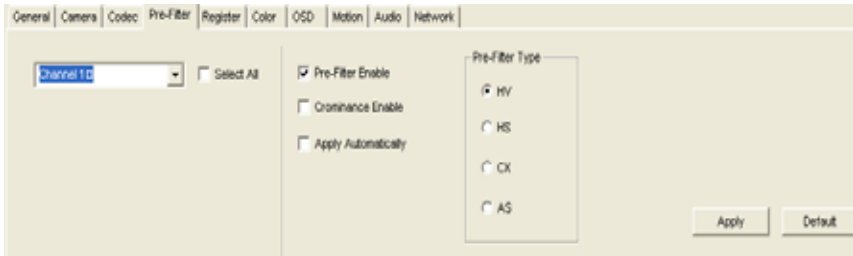

- 1) Choose Encoding Path. (Possible to set per each path)
- 2) [Pre-Filter Enable]: Activate filter function of chosen Path.
- 3) [Crominance Enable] : It activate the noise reduction function in the chrominance level.
- 4) [Apply Automatically] : If you check [Apply Automatically] clause, the filter function is activated automatically when the noise-image put into
- 5) [Pre-Filter Type] : It sets kinds of filter.

- **HV** : It has the lowest level of noise-reduction function. The improving effect of compression rate is very small and the picture quality is maintained as the original one.
- **HS** : It has lower level of noise-reduction function. The improving effect of compression rate is is small and the picture quality is maintained as nearly as the original one.
- **CX** : It has middle level of noise-reduction function. The improving effect of compression rate is better. The picture quality is little lower and the resolution in the border of the original one become dim.
- **AS** : It has high level of noise-reduction function. The improving effect of compression rate is best. The picture quality is lower and the resolution in the border of the original one become dimmer.

1.7.4 < Register >

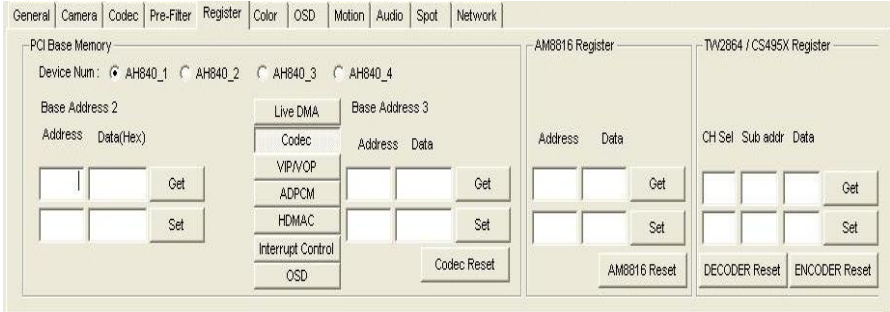

1) Register Tap could set PCI Base Memory of BAR2/BAR3, AM8816, TW2864.

2) You could access on the register of each function by using various taps PCI Base Memory BAR3.

3) [Get] button shows the selected IC Register on the Data space, [Set] button write the input value of Data space on the chip's Address.

(Caution) You have to 16 hex character in Address and Data space.

Ex) 31(0), 3B(0), 0x3C (X)

1.7.5 < Color >



1) Each channel or all channel at the same time could set [Brightness], [Contrast], [Color], [Hue].

2) Choose the channel in the left and set the value in the right.

3) If you want to set at the same time, check and set [All]

4) If you press Default on the right below side, all channel will be initialization.

1.7.6 <OSD >



- 1) It could be revised the OSD to be seen by PC, TV Monitor.
- 2) Each camera has been set channel number as a default like channel 1.
- 3) If it click [Start] in the [Capture] after revising OSD and checking [EncdeOSD], the revised letter is displayed in the Monitor screen.
- 4) If you don't want see OSD, it has only to do disable [EncdeOSD] after stopping [Capture].

1.7.7 <Motion >

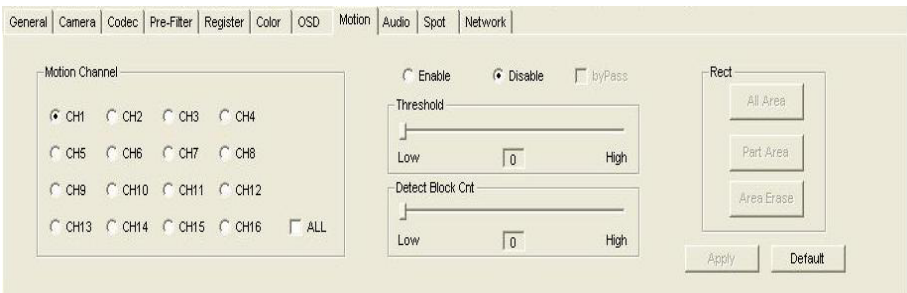

- 1) It is set the [Motion Capture Enable], [Threshold], [Detect Block Count], [Rect] In Motion tap.
- 2) On the occasion of choosing only one channel in [Motion Channel], input setting value is applied in the just chosen channel.
- 3) On the occasion of checking [ALL] check box, it could set all channel value at one time.
- 4) It is controlled sensitivity of Motion Detect in slide bar of [Threshold] block.
- 5) It could control block-count to recognize motion by using slide-bar of

[Detect Block Count].

6) It could choose motion part in [Rect].

a) [All Area] – Designated all area into motion part.

b) [Part Area] – Designated part of screen into motion part by using mouse.

c) [Area Erase] – deleted all designated part.

1.7.8 <Audio>

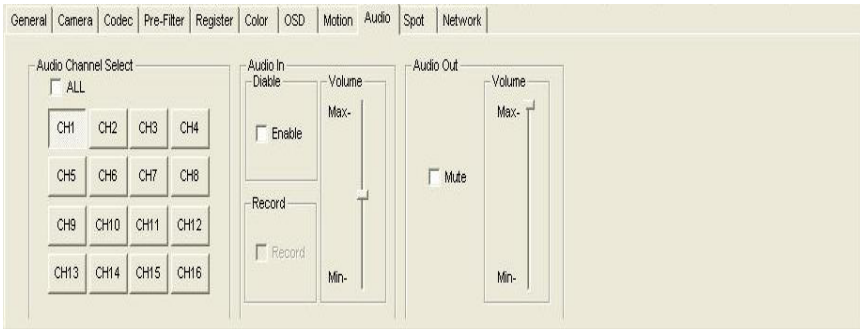

1) [Audio] support 16ch and each channel is possible to enable or record.

2) Volume control is possible in each [Audio In], [Audio Out].

4) If it check all in [Audio Channel Select], all channel is chosen and could set at one time.

Note : SDK does not support audio playback function.

1.7.9 < Spot >

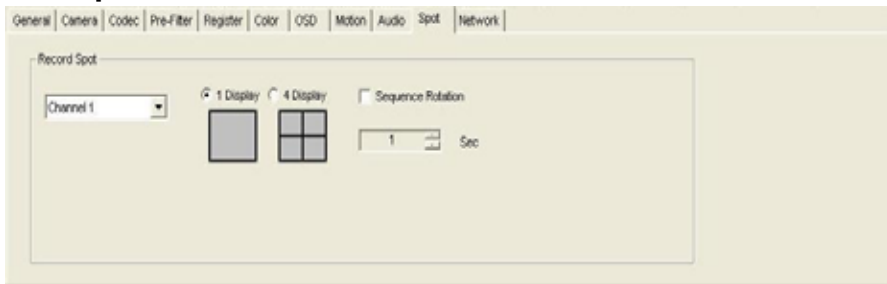

SPOT Monitor select display mode 1 or 4 & Sequence Rotation 1~5 sec

1.7.10 <Network>

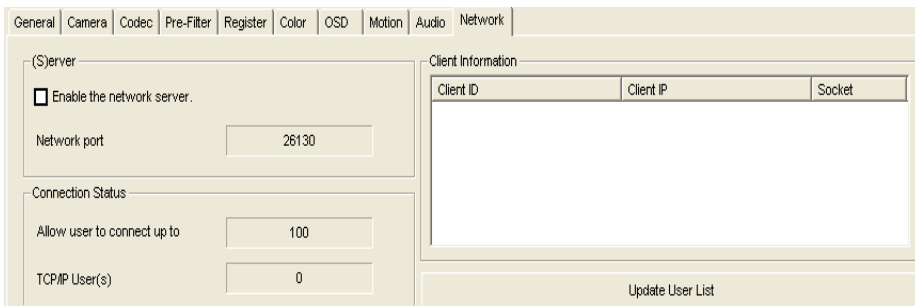

Enable or Disable the Network Server.

1.8 <Play back program>

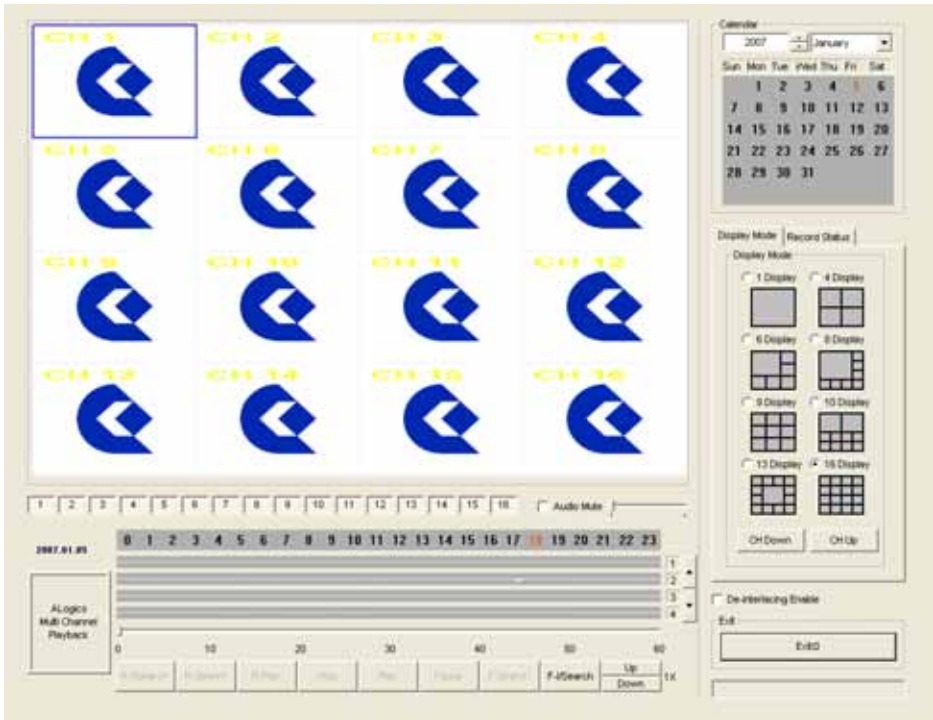

If you play **AHWinplayer.exe**, it will come out like upper. This is the program for play recorded video image.

The recorded file folder at **C:\Alogics** or **D:\Alogics...**

Video file → xxxxxx.264

Audio file → xxxxxx.g721

Note:

SDK does not support audio playback function.

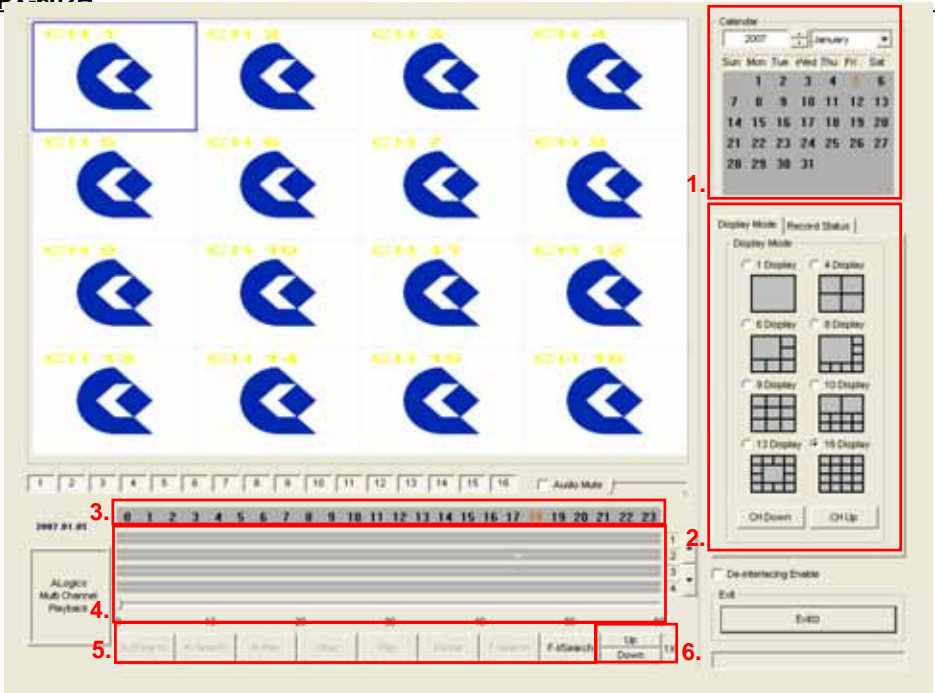

- 1) Calendar status : It displays recorded date and chosen date in right upper part. The chosen date is displayed by red color and the recorded date is displayed with shadow by dark color. It could choose the date by clicking mouse.
- 2) You can choose the partition mode on the right side of Display Mode tab.
- 3) Time status : It is displayed the recorded time by hours and minutes in the below part. The number of 0~24 means time and the chosen time is displayed by red color and the recorded time is displayed with shadow by dark color. It could choose the time by clicking the number.
- 4) Minute unit status : The chosen time is divided by 60 minutes and displayed in the right below part. A default is displayed 60 minute in 4 channel. On the occasion of having the recorded part, it is display with shadow. If it clicks the point which you want to search, it is displayed by minute unit.
Slide bar : It could control the time which you look for by moving the slide bar. The slide bar is fit into minute unit.

5) Play button : There are buttons related play in the below part of slide bar.

From left, there are (R-I/Search : moving per I frame unit in reverse), (R-Search: moving per a picture in reverse), (Stop), (Play), (Pause), (F-Search: moving per a picture), (F-I/Search :moving per I frame unit).

6) speed control : There are [Up], [Down] buttons related speed in the right side of button related play. When it play or play in reverse, it could control the speed and support 1/32, 1/16, 1/8, 1/4, 1/2, 1, 2, 4, 8, 16, 32 times.

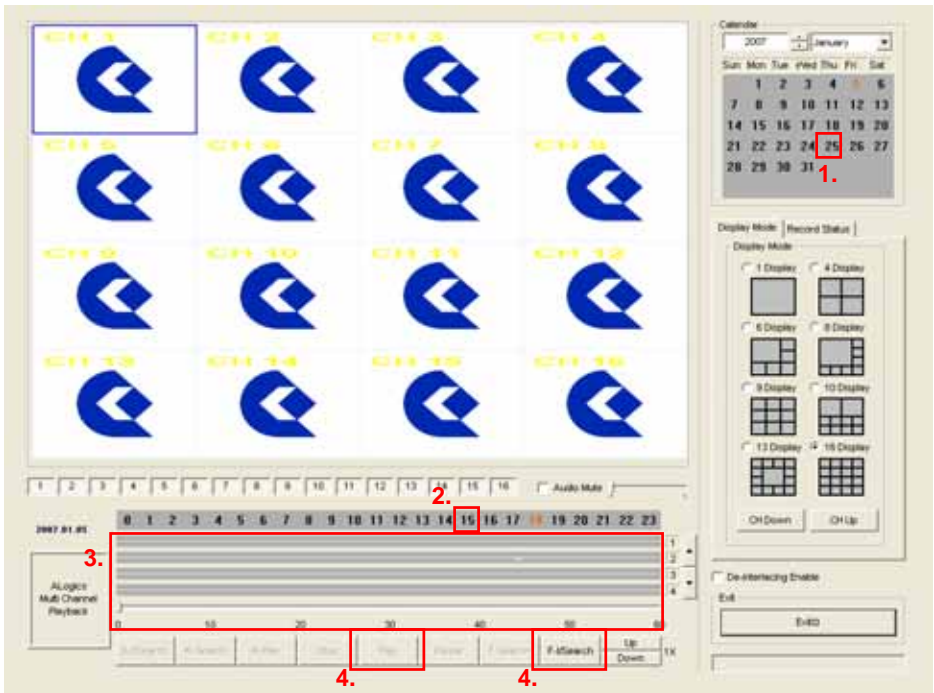

If you want to play the recording data, please follow up below step.

- 1) Select the date in the upper-right side calendar.
- 2) Select the hour in the hour menu below screen.
- 3) Select the minute in the minute menu below the application program, then slide bar will be moved to the place.
- 4) I/Search button, you can find out the nearest I-Frame. Then push the play button.

1.9 <Network Streaming program>

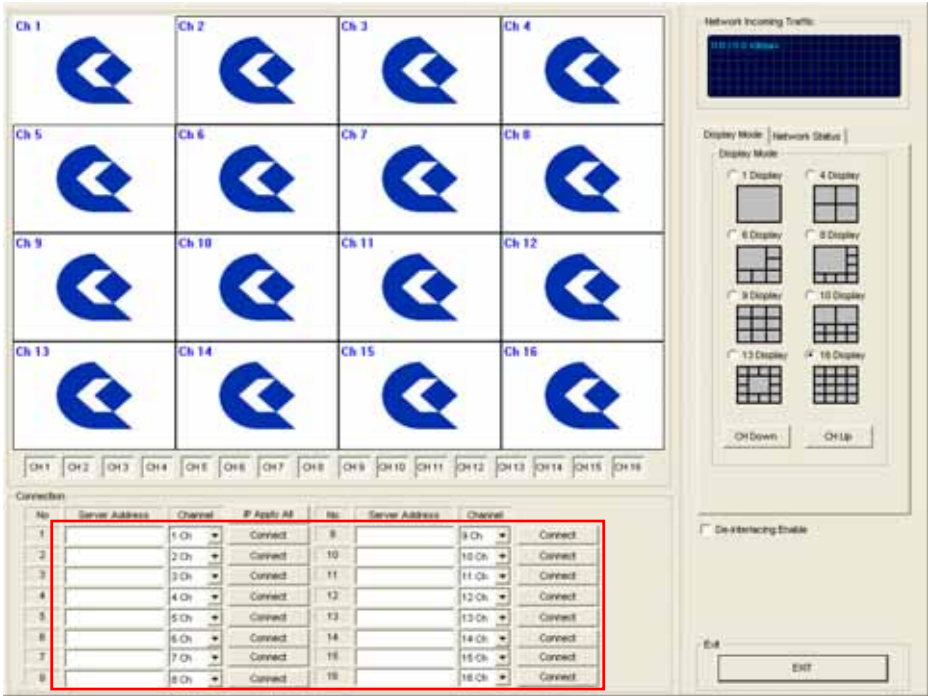

**Copy the Driver folder to your remote PC and run NetViewer.exe
 You'll see the network streaming program GUI .
 Then , Fill in the IP Address and Push the Connect .**

Contact Information

Any advice or comment about our products and service, or anything we can help you please don't hesitate to contact with us. We will do our best to support you for your products, projects and business.

Taiwan Commate Computer Inc.

Address	19F, No. 94, Sec. 1, Shin Tai Wu Rd., Shi Chih Taipei Hsien, Taiwan
TEL	+886-2-26963909
FAX	+886-2-26963911
Website	http://www.commell.com.tw
E-Mail	info@commell.com.tw (General Information) tech@commell.com.tw (Technical Support)

Commell is the trademark of Taiwan Commate Computer INC.