

DIBOSS

30"/32" WIDE TFT LCD TV/MONITOR

Owner's Manual

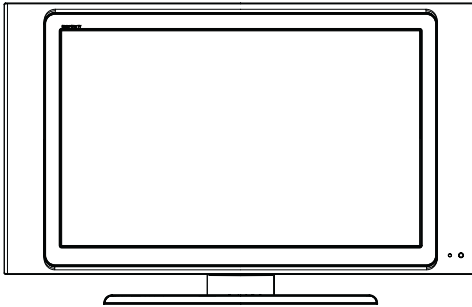

Model:LT-30HLF
/LT-32HLF

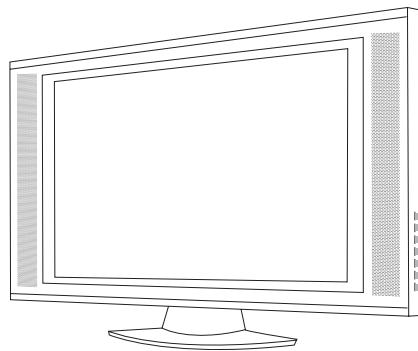

Model:LT-30FLF

Model: **LT-30FLF/LT-30HLF/LT-32HLF**

Warnings



WARNING
RISK OF ELECTRIC SHOCK
DO NOT OPEN



WARNING :

To reduce the risk of electric shock do not remove cover (or back).
No user serviceable parts inside. Refer servicing to qualified service personnel.



The lightning flash with arrowhead symbol, within an equilateral triangle, is intended to alert the user to the presence of uninsulated “dangerous voltage” within the product’s enclosure that may be of sufficient magnitude to constitute a risk of electric shock to persons.



The exclamation point within an equilateral triangle is intended to alert the user to the presence of important operating and maintenance (servicing) instructions in the literature accompanying the appliance.

WARNING :

To prevent fire or shock hazard, do not expose the set to rain or moisture. Do not rub or strike the Active Matrix LCD with anything hard as this may scratch, mar, or damage the Active Matrix LCD permanently.

CAUTION:

Do not attempt to modify this product in any way without written authorization. Unauthorized modification could void the user’s authority to operate this product.

Power(Model:LT-30FLF/LT-30HLF)

This set operates on a DC supply provided by the AC-DC adaptor, the voltage is as indicated on the label on the back cover. Use only the AC-DC adaptor supplied with the set and never apply an AC mains to the set directly. The AC-DC adaptor operates on an AC mains supply, the voltage is as indicated on the label of the AC-DC adaptor.

- Connect the DC plug of the AC-DC adaptor to the 24V socket of the set.
- Connect the AC-DC adaptor and its power cord.
- Connect the power cord to an AC mains.

In the event of thunderstorms or power cuts, please pull out the mains plug of the AC-DC adaptor and the aerial plug. Do not allow anything to rest upon or roll over the power cord, and do not place the set where the power cord is subject to damage.

Warnings

Service

Never remove the back cover of the TV, this can expose you to high voltage and other hazards. If the TV does not operate properly, unplug it and call your dealer. Connect the antenna cable to the connection marked Ant. (on the rear). For best reception, use an outdoor antenna.

Location

Position your TV so that no bright light or sunlight will shine directly on the screen. Do not expose the TV to vibration, moisture, dust or heat. Also ensure that the TV is placed in a position that allows a free flow of air. Do not cover the ventilation openings on the back cover. You can install the TV on a wall or place it on a table-top or similar flat surface. Mounted the TV securely to eliminate the risk of injury from the TV falling.

Cleaning

Unplug the TV before cleaning the face of the LCD Screen. Dust the TV by wiping the screen and cabinet with a soft, clean cloth. If the screen requires additional cleaning, use a clean, damp cloth. Do not use liquid or aerosol cleaners.

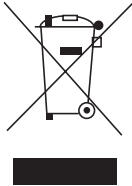

Note:

This product is designed and manufactured with high quality materials and components which can be recycled and reused.

This symbol means that electrical and electronic equipment, at their end-of-life, should be disposed of separately from your household waste.

Please, dispose of this equipment at your local community waste collection/recycling centre.

In the European Union there are separate collection systems for used electrical and electronic product.

Please, help us to conserve the environment we live in!

Contents

Before operating the set, please read this manual carefully.

Warnings	3~4
Contents	5
Supplied Accessories	6
Controls	7~9
Controller of panel	7
Remote controller	8~9
Basic Operation	10
Turning the TV On and Off	10
Programme selection	10
Volume adjustment	10
Q.View	10
Sound mute function	10
On screen Language selection	10
On Screen Menus and Displays	11
Setting up TV Programme	12~14
Auto Programme	12
Manual Programme	13
Programme Edit	14
Picture Control	15
Manual picture control	15
Auto picture control	15
Sound Control	16~17
Other functions	18~19
Clock	18
Blue Back	18
Auto Sleep	19
Childlock	19
Radio	19
ARC	19
Radio Control	20
Other functions	21
Teletext	22~23
Text On/Off	22
TOP text	22
FLOF text	22
Special Teletext function	23
External Equipment Connection	24~25
Antenna connection	24
SCART 1,2	24
S-VIDEO Input	25
Headphone jack	25
Connecting the PC as a monitor	26~29
Product specification	30
Troubleshooting	31
Limited Warranty	32

Supplied Accessories

■ Make Sure the following accessories are provided with Product.

1. AC/DC adaptor(Model:LT-30FLF/LT-30HLF)

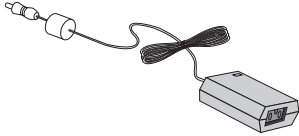

2. AC Cord



3. Remote controller



4. Batteries (type AAA)

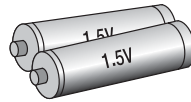

5. Owner's manual

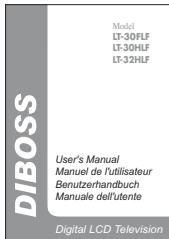

6. PC IN cable



7. PC Audio IN cable



Controls

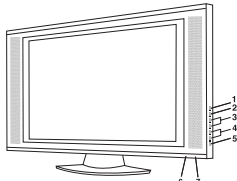

Model:LT-30FLF

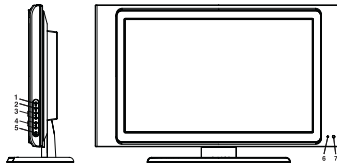

Model:LT-30HLF/LT-32HLF

1. **ON/OFF** Switches TV set on or off.
2. **MENU** Displays a menu.
3. **+ PR** - (Programme Up/Down) Selects a programme or a menu item.
4. **+ VOL** - (Volume Up/Down) Adjusts the volume./ Adjusts menu settings.
5. **TV/AV** Selects TV, SCART1, SCART2, S-VIDEO, RADIO(Only when the set is Radio On.) or PC Analog or PC Digital mode. / Clears the menu from the screen.
6. **Power Indicator**
Illuminates in red when the TV is in standby mode./ Illuminates in green when the TV is switched on. Illuminates in amber when the power save mode (only PC mode).
7. **Remote control sensor**
Accepts the IR signal of remote controller.

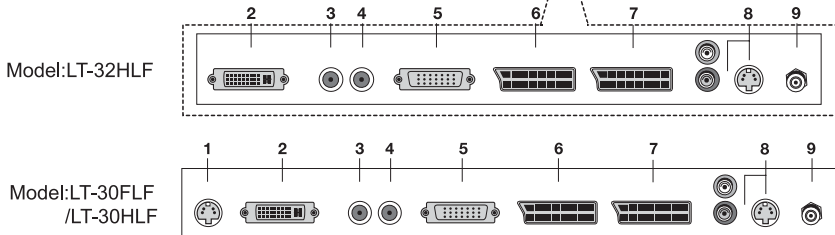
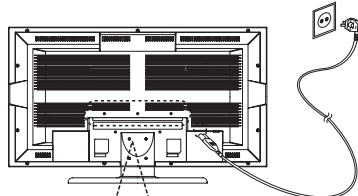

1. **DC24V IN**
2. **PC DIGITAL IN (DVI-I)**
3. **H/P (Headphone out)** Connect a headphone to this socket.
4. **PC AUDIO IN**
Connect the audio cable from the PC to the **PC AUDIO IN** of the set.
5. **PC ANALOG IN (D-SUB)**
6. **SCART1(Full)**
Connect the Audio/Video outputs of external equipment to scart jack.
7. **SCART2 (Half)**
8. **S-VIDEO IN**
Connect the output of the S -VIDEO on the VCR to the S-VIDEO input.
Connect the audio outputs of the S-VIDEO on the VCR to the Audio IN (L(MONO), R).
9. **Ant. (Antenna input)**

Controls

All the functions can be controlled with the remote controller. Some functions can also be adjusted with the buttons on the side panel of the set.

Remote controller

Before you use the remote controller, please install the batteries.

1. POWER

Turns the TV on from standby or off to standby mode.

2. MUTE

Turns the sound on and off.

3. NUMBER buttons

Selects programme numbers.

4. TV/AV

Selects TV, SCART1, SCART2, S-VIDEO, RADIO(Only when the set is Radio On.), PC Analog or PC Digital mode. Clears the menu from the screen.

5. MENU

Displays a main menu.

6. LIST

Displays the programme list menu.

7. I/II

Selects the language during dual language broadcast. Selects the sound output.

8. SLEEP

Sets the sleep timer.

9. Q.VIEW

Returns to the previously viewed programme.

10. PR▲▼ (Programme Up/Down)

Selects next programme or a menu item.

11. OK

Accepts your selection or displays the current mode.

12. VOL◀▶ (Volume Up/Down)

Adjusts the sound level. Adjusts menu settings.

13. TV/PC

Selects TV or PC mode directly.

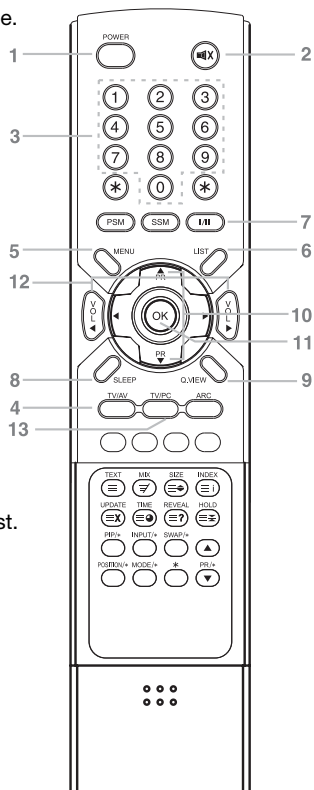

Controls

14. PSM (Picture Status Memory)

Recalls your preferred picture setting

15. SSM (Sound Status Memory)

Recalls your preferred sound setting

16. ARC

You can watch TV in various picture formats; **Auto, 16:9, 14:9, 4:3, 16:9 Zoom, 14:9 Zoom, 4:3 Zoom.** Repeatedly press the **ARC** button to select your desired picture format.

Note. 16:9 and 4:3 in PC mode are available.

17. TELETEXT buttons

These buttons are used for Teletext. For further details, see the 'Teletext' section.

18. INPUT/*

Selects the AV source of sub picture in PIP mode.

19. PIP/*

Displays a PIP(Picture In Picture) screen. The PIP function is available in PC Analog or PC Digital mode.

20. POSITION/*

Selects a position of PIP screen.

21. SWAP/*

Switches a main picture for sub picture in PIP mode. The PIP screen will disappears after pressing the SWAP button.

22. MODE/*

Selects a PIP screen mode. - 16:1, 9:1 and 3:1 mode.

23. PR/* ▲ ▼

Selects a programme when RF signal is displayed in PIP mode.

24. ◀ ▶

Adjusts menu settings. Adjusts the sound level.

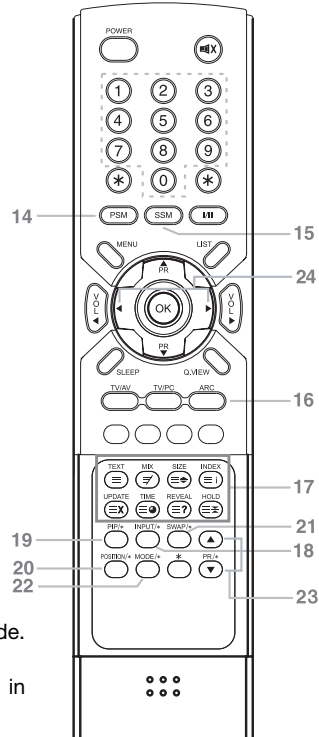

Battery installation

■ Inserting batteries

1. Remove the battery cover by pulling it upward in the direction shown by the arrow.
2. Insert the batteries with correct polarity ("+" to "+", and "-" to "-").
3. Replace the battery compartment cover.

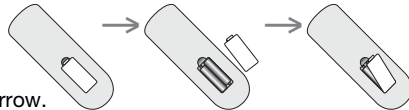

* Install two high-quality 1.5V "AAA" alkaline batteries. Don't mix old batteries with new batteries.

* Remove batteries when you won't use the remote controller for a long time. Liquid leakage from old batteries may cause operation failure.

■ Notes for using remote controller

- Make sure there are no objects between the remote controller and its sensor.
- Don't place the remote control near a heater or in damp place. Strong impact to the remote control may cause operation failure.
- Signal from the remote control may be disturbed by sun light or other bright light. In this case, darken the room or move the TV.

Basic Operation

Turning the TV On and Off

Standby Setup: The AC-DC adapter(Model:LT-30FLF/LT-30HLF) and the AC power cord must be set up and connected to have the TV in standby mode ready to be turned on. Press the **ON/OFF** button on the side panel of the TV to go into standby mode.

1. If the TV is in standby mode, press the **POWER** button on the remote controller or the TV itself to turn the TV on.
2. Press the Power button again on the remote controller or the **ON/OFF** button the TV itself to turn the TV off.

Note : If the TV is on and the **POWER** button is pressed to turn the TV off, the TV goes into standby mode.

Programme selection

You can select a Programme number with the **PR▲▼** button or **NUMBER** buttons.



Volume adjustment

Press the **VOL◀▶** button to adjust the sound level.

Quick view

Press the **Q.VIEW** button to view the last Programme you were watching.

Sound mute function

Press the **MUTE**() button. The sound is switched off and the mute display  appears.

To cancel mute mode, press the **MUTE**() button again,

VOL◀▶ or **SSM** button.

On screen menu language selection

The menu can be displayed on the screen in desired language. First, select your language.

1. Press the **MENU** button.
2. Select the **Setup** menu.
3. Select the **Language** menu.
4. Press the **PR▲▼** button to select your desired language.
5. Press the **TV/AV** button.

All the on screen displays will appear in the selected language.

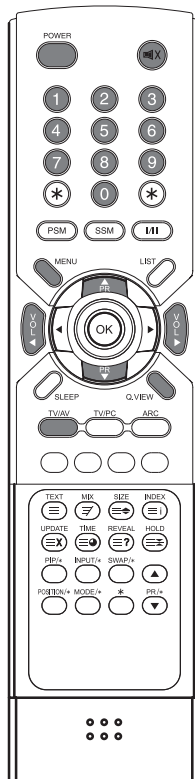

On Screen Menus and Displays

1. Press the **MENU** button to display main menu.
2. Press the **PR▲▼** button to select menus-Picture, Sound, Special, Setup.
3. Adjust each menu with the **◀▶** button.
4. Press the **MENU** button to return to preceding menu.
5. Press the **TV/AV** button to finish adjusting menu.

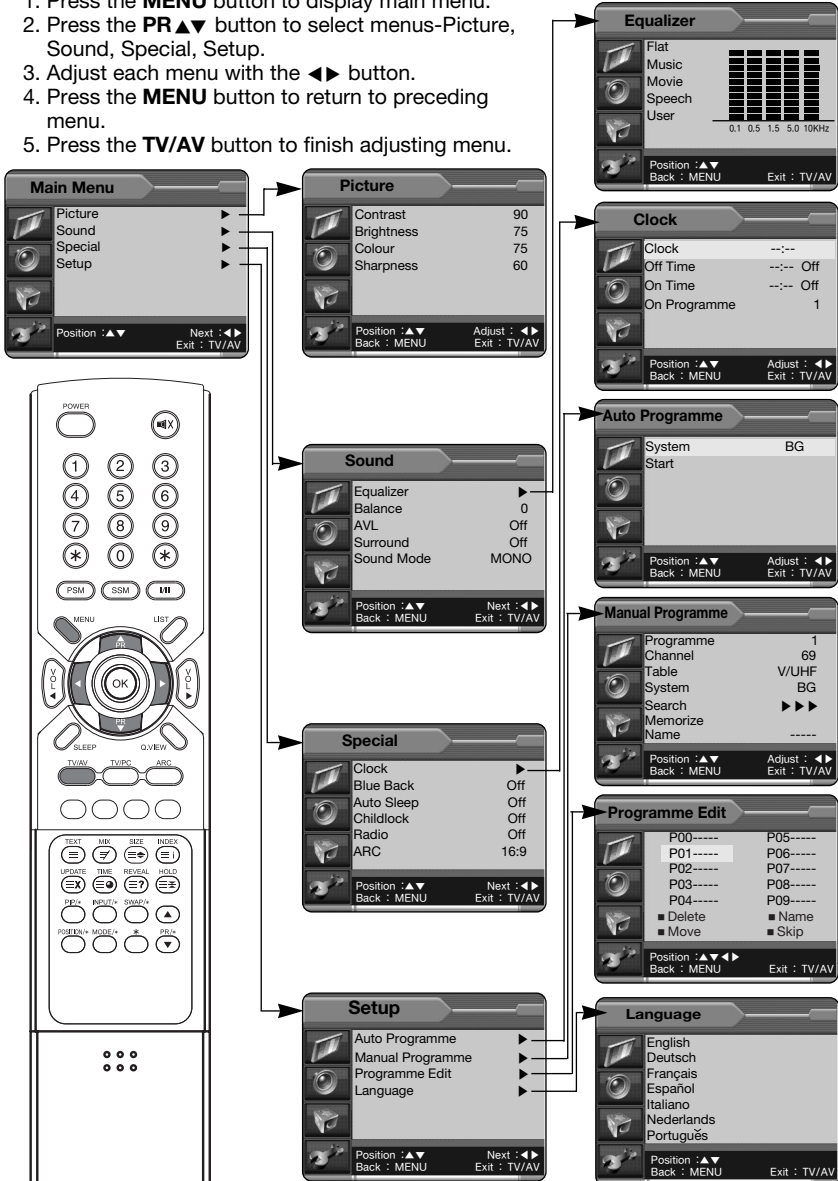

Setting up TV Programme

Once you have preset the programmes, you will be able to use the **PR** ▲ ▼ or **NUMBER** buttons to scan the programmes you programmed. Programmes can be tuned using automatic or manual modes.

Auto Programme

All programmes that can be received are stored by this method. It is recommended that you use Auto programme during installation of this set.



1. Press the **MENU** button.
2. Select the **Setup** menu.
3. Select the **Auto Programme** menu.
4. Press the **PR** ▲ ▼ button to select **System**.
5. Select a TV system with the ◀ ▶ button;
BG : (Germany/Asia/M.East/Africa/Australia)
I : (UK/Hong Kong/South Africa)
DK : (CIS/China/East Europe)
L : (France)
6. Select the **Start** menu to start **Auto Programme**.
7. Press the **MENU** button to stop Auto programme
8. Press the **TV/AV** button to return to normal TV viewing.

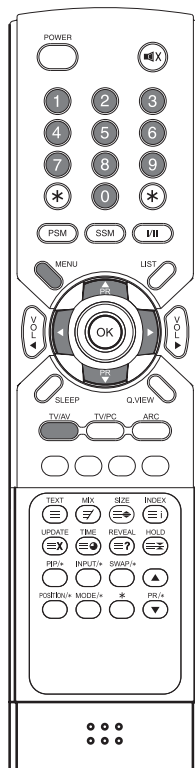

Setting up TV Programme

Manual Programme

Manual Programme lets you manually tune and arrange the programmes in whatever order you desire. Also you can assign a programme name with 5 characters to each programme number.

1. Press the **MENU** button.
2. Select the **Setup** menu.
3. Select **Manual Programme** menu.
4. Select a programme with the ◀▶ button or number buttons.
5. Press the **PR▲▼** button to select **Channel** menu.
6. Press the ◀▶ button or directly number buttons to select a Channel.
7. Press the **PR▲▼** button to select the **Table** menu.
8. Press the ◀▶ button to select **V/UHF** or **Cable** as required.
9. Select a TV system with the ◀▶ button.
 - BG** : (Germany/Asia/M.East/Africa/Australia)
 - I** : (UK/Hong Kong/South Africa)
 - DK** : (CIS/China/East Europe)
 - L** : (France)
10. Press the **PR▲▼** button to select **Search** menu.
When you press the ◀▶ buttons, the TV starts to search adjacent channel downward or upward.
11. Press the **PR▲▼** button to select **Memorize** menu.
12. Press the ◀▶ button to store it.
13. Press the **MENU** button to return to prior menu.
14. Press the **TV/AV** button to return to normal TV viewing.

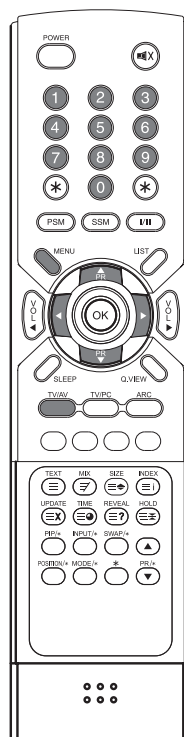

Setting up TV Programme

Programme Edit

This function enables you to delete or skip the stored programmes.

Also you can move some programmes to other programme numbers or insert a blank programme data into the selected programme number.

1. Press the **MENU** button.
2. Select the **Setup** menu.
3. Press the **PR▲▼** button select **Programme Edit** menu.
4. Select the programme name to edit with the **PR▲▼** and **◀▶** button.



Deleting a programme

1. Select a programme to be deleted with the **PR▲▼** or **◀▶** button.
2. Press the **RED** button once. The selected programme is deleted, all the following programme is shifted up one position.

Naming a programme

1. Select a programme to be named with the **PR▲▼** or **◀▶** button.
2. Press the **GREEN** button. Then it display as below.



3. Press the **PR▲▼** button repeatedly to edit programme name. You can use the numeric 0 to 9, the alphabet A to z (capital and small letters,) a blank and -. With the **◀▶** button, you can select in the opposite direction.
4. Press the **OK** button to store it.
5. Press the **MENU** button to return to prior menu.
6. Press the **TV/AV** button to return to normal TV viewing.

Moving a programme

1. Select a programme to be moved with the **PR▲▼** or **◀▶** button.
2. Press the **YELLOW** button.
3. Move the programme to desired programme number with the **PR▲▼** or **◀▶** button.
4. Press the **YELLOW** button again to release this function.

Skipping a programme number

1. Select a programme number to be skipped with the **PR▲▼** or **◀▶** button.
2. Press the **CYAN** button. The skipped programme turns to blue.
3. Press the **CYAN** button again to release the skipped programme.

Note: When a programme number is skipped it means that you will be unable to select it using the **PR▲▼** button during normal TV viewing. If you want to select the skipped programme, directly enter the programme number with the **NUMBER** buttons or select it in the **Programme Edit**.

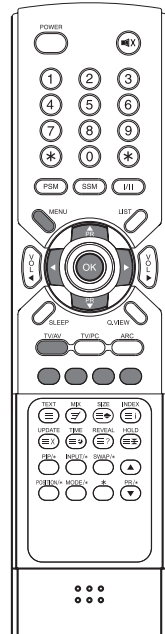

Picture Control

You can adjust picture **Contrast**, **Brightness**, **Colour**, **Sharpness** and **Tint**(only in NTSC mode) to the levels you prefer.

Manual Picture Control

1. Press the **MENU** button.
2. Select the **Picture** menu.
3. Press the **PR ▲ ▼** button select a picture item.
4. Press the **◀ ▶** button to adjust the picture condition as you want.
5. Press the **TV/AV** button to store for the picture **User**.



Selected Item	Setting Change
Contrast	More darkness ◀ 0~100 ▶ More light
Brightness	Less bright ◀ 0~100 ▶ More bright
Colour	Lower color intensity ◀ 0~100 ▶ Higher color intensity
Sharpness	Soft picture ◀ 0~100 ▶ Sharp picture
Tint*	More purple ◀ -50~50 ▶ More green

Auto Picture Control

*The Picture options - Dynamic, Standard, Mild and Game are programmed for good picture reproduction at the factory and cannot be changed.

PSM (Picture Status Memory)

1. Press the **PSM** button.
2. Press the **PSM** button repeatedly to select [PSM].

Each press of the button changes the screen display as below.

Dynamic → **Standard** → **Mild** → **Game** → **User**



- **Dynamic** : Vivid Picture Appearance
- **Standard** : Standard Picture Appearance
- **Mild** : Softer Picture Appearance
- **Game** : External Video Game Picture Setup
- **User** : Manual Picture Setup

Note. In PC mode, **PSM** function isn't available.

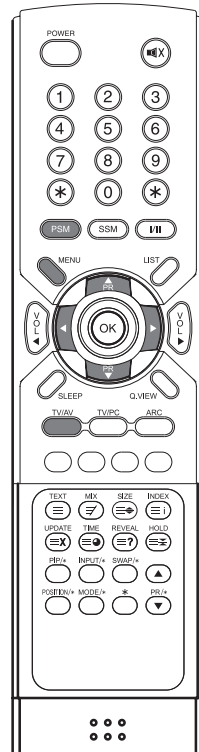

Sound Control

You can select your preferred sound setting; **Flat**, **Music**, **Movie** or **Speech**. You can also adjust the sound frequency of equalizer, balance. If you switch **AVL** to on, the set automatically keeps on an equal volume level even if you change programmes.

1. Press the **MENU** button.
2. Select the **Sound** menu.
3. Press the **PR**▲▼ button to select the desired sound item; **Equalizer**, **Balance**, **AVL**, **Surround** or **Sound Mode**.
4. Press the ◀▶ button to make desired adjustment.
5. Press the ◀▶ button in **Equalizer** to set the **Equalizer**.

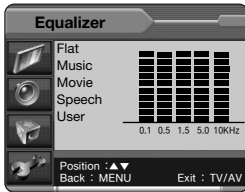

6. Press the **PR**▲▼ button to select your preferred setting ; **Flat**, **Music**, **Movie**, **Speech** or **User**.
To set the Equalizer User.
 - a. Select **User** by pressing the **PR**▲▼ button.
 - b. Select a sound band by pressing the ◀▶ button.
 - c. Make appropriate sound level with the **PR**▲▼ button.
 - d. Press the **MENU** button to return to preceding menu.
7. Press the **PR**▲▼ button to the **Balance** menu.
8. Select the **Balance** menu with the ◀▶ button and adjust the balance of speaker.
9. Select the **AVL**(Automatic Volume Leveler) menu **ON** or **OFF**.
10. Select the **Surround** menu **On** or **Off**.
11. Select the **Sound Mode** menu.

If the sound quality is poor while you are watching a programme broadcast in Stereo, select **MONO** with the ◀▶ button. Press the ◀▶ button to switch between **MONO** and **STEREO**.(Please note that it works only when the broadcast is done in stereo).

If a programme is received in two language(dual language), you can switch to **DUAL I** or **DUAL II** by pressing the ◀▶ button repeatedly.

DUAL I sends the primary broadcast language to the loudspeakers.

DUAL II sends the secondary broadcast language to the loudspeakers.

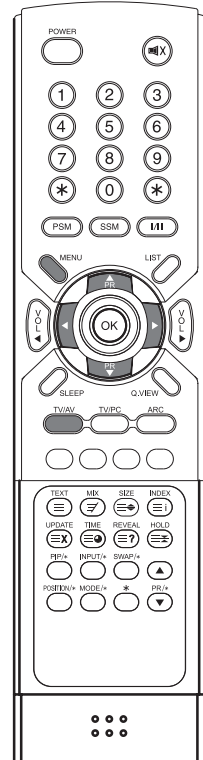

Sound Control

Auto Sound Control

* The sound **Flat**, **Music**, **Movie** and **Speech** are programmed for good sound reproduction at the factory and cannot be changed.

SSM (Sound Status Memory)

1. Press the **SSM** button.
2. Press the **SSM** button repeatedly to select.

Each press of the button changes the screen display as below.

Flat → **Music** → **Movie** → **Speech** → **User**



- Choose **Flat** for the standard factory settings.
- Choose **Music** when watching music video or concerts.
- Choose **Movie** when watching movies.
- Choose **Speech** when watching a show that is mostly dialogue.
- Choose **User** to recall your personalized settings.

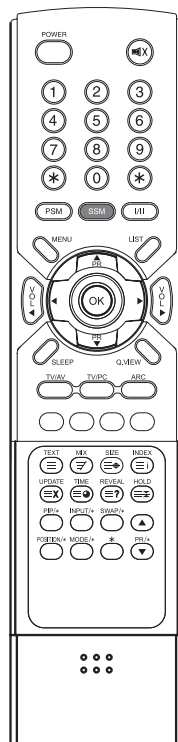

Other functions

You can control other functions; **Clock**, **Blue Back**, **Auto Sleep**, **Childlock**, **Radio** and **ARC** menu.

Clock

Setting the clock is necessary in order to use the various timer features of the TV. You can set automatic TV **On** or **Off** time.

1. Press the **MENU** button.
2. Press the **PR**▲▼ button to select the **Special** menu. Then press the ◀▶ button.
3. Press the ◀▶ button to select **Clock** menu.



4. Set the present time with the numeric buttons and the **PR**▲▼ button on remote controller. Store a time value between 00:00 ... 23:59(hours:minutes)
5. Press the **PR**▲▼ button to select **Off Time**.
6. Set the TV off time with the numeric buttons and the **PR**▲▼ button. Then press the ◀▶ button. Select **On** or **Off** with **PR**▲▼ button.(When the setting is off, the TV set will be switched off to stand by mode.)
7. Press the **PR**▲▼ button to select **On Time**.
8. Set the TV on time with the numeric buttons and the **PR**▲▼ button. Then press the ◀▶ button. Select **On** or **Off** with **PR**▲▼ button. When the setting is On, the set will be switched On automatically to the last selected programme.
9. Press the **PR**▲▼ button to select **On Programme**. You can select the first displayed programme with the ◀▶ button when the set is switched on automatically.
10. Press the **TV/AV** button to return to normal TV viewing.

Note. The present time must be set for using the **Clock** function.

Blue Back

If no signal is being received or the signal is very weak, a blue screen automatically replaces the noisy picture background.

If you wish to continue viewing the poor picture, you must select the **Blue Back On**.(Pressing the ◀▶ button will alternate between “On” and “Off”.)

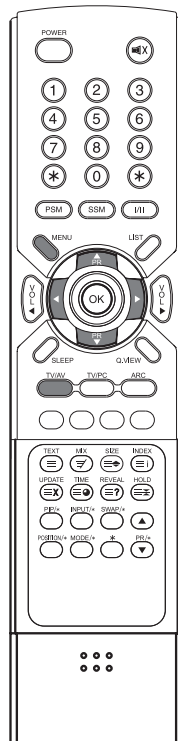

Other functions

Auto Sleep

If you select **Auto Sleep On** the set will automatically switch itself to standby mode approximately ten minutes after a TV Channel stops broadcasting.

1. Press the **MENU** button.
2. Select the **Special** menu.
3. Press the **PR▲▼** button to select **Auto Sleep**.
4. Press the **◀▶** button to select **On**.
5. Press the **TV/AV** button to return to normal TV viewing.

Note. If the set connects with the external input source in the middle of a lapse of 10 minutes after a TV channel stops broadcasting, Auto Sleep function is automatically canceled.

Childlock

Childlock menu is necessary in order to disable the buttons on the side panel of the set. Especially it is useful to prevent unauthorized viewing.

1. Press the **PR▲▼** button to select **Childlock**.
2. Press the **◀▶** button repeatedly to select **On** or **Off**.

* When the setting is **Childlock On**, the buttons on the side panel of the set is disabled.

* When the setting is **Childlock Off**, the buttons on the side panel of the set is enabled.

Radio

You can listen to radio with the set.

1. Press the **MENU** button.
2. Press the **PR▲▼** button to select the **Special** menu.
Then press the **◀▶** button.
3. Press the **PR▲▼** button to select Radio.
4. Press the **◀▶** button to select Radio **On** or **Off**.

Note. When the setting is **On**, you can adjust radio function in radio mode. (see page 20)

ARC (Aspect Ratio Control)

You can watch TV in various picture formats; **Auto, 16:9, 14:9, 4:3, 16:9 Zoom, 14:9 Zoom, 4:3 Zoom**.

Repeatedly press the **ARC** button to select your desired picture format.

Auto When your set receives the wide screen signal, it will change automatically the picture format that has been sent.

16:9 You can enjoy the cinema or general TV programme through the 16:9 mode.
The screen 16:9 is viewed just like that but the screen 4:3 is magnified to the left and right so that the screen 16:9 is full.

14:9 You can enjoy the picture format of 14:9 or general TV programme through the 14:9 mode.
The screen 14:9 is viewed just like that the screen 4:3 is magnified to the upper/lower and left/right.

4:3 This picture format is 4 to 3 of general TV.

16:9 Zoom Magnifies the size of the picture on screen 16:9.

14:9 Zoom Magnifies the size of the picture on screen 14:9.

4:3 Zoom Magnifies the size of the picture on screen 4:3.

Note. In **Zoom** mode, you can adjust the position of the picture with **PR▲▼** button.
(It's possible when the **ARC** information is displayed on screen.)

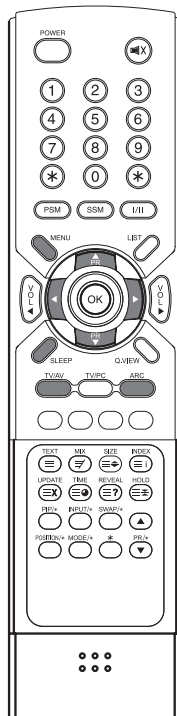

Other functions

PIP function

PIP will let you view two separate source inputs on your TV screen at the same time.

Viewing the PIP picture

Press the **PIP/*** button. (Press the PIP/* button again, to turn PIP off.)

Note : PIP function is available when the main picture is in PC Digital, PC Analog mode.

Selecting the PIP picture mode

Press the **MODE/*** button to adjust the PIP picture mode. Each press the **MODE/*** button, selects the 16:1, 9:1 and 3:1 mode.

Moving the PIP picture

Press the **POSITION/*** button to adjust the position of sub picture in PIP mode.

Switching the main picture to the sub picture

Press the **SWAP/*** button to switch off PIP and sub picture switch to main picture simultaneously.

Viewing the external source input

Press the **INPUT/*** button to select the input source of sub picture in PIP mode.

Press the **PR/*▲▼** button to select the programme desired in TV mode of sub picture.

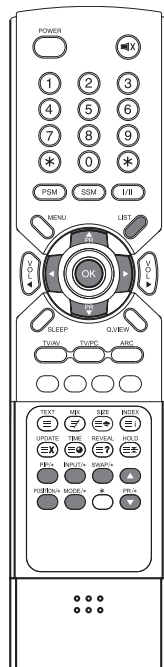

Calling the programme list

You can check the programmes stored in the memory by displaying the Programme List.

Displaying programme list

1. Press the **LIST** button to display the Programme list menu.

The programme list appears on the screen.

One programme list contains ten programmes as right.

Note :

a. You may find some blue programmes.

They have been set up to be skipped by auto programming or in the programme edit mode.

b. Some programmes with the channel number shown in the programme list indicate there is no station name assigned.



Selecting a programme in the programme list

Select a programme with the **PR▲▼** or **◀▶** button. Then press the **OK** button. The set switches to the chosen programme number.

Paging through a programme list

There are 10 programme table pages in which contain 100 programmes. Pressing the **PR▲▼** or **◀▶** button repeatedly turns the pages.

TELETEXT

TEXT On/Off

Press the **TEXT** button to switch to TELETEXT.
The initial page or last selected page appears on the screen.
The first page number indicates your selection,
while the second shows the current page displayed.

1. Press **TEXT** button once, displays the Teletext pages.
Press **MIX** button once more, displays the Teletext pages superimposed on the TV picture.
2. If you press the **TEXT** button twice, the teletext pages and the TV picture are concurrently displayed on both sides of the screen.
3. Press the **TEXT** button to switch off Teletext once more, Text mode is off, and TV mode appears.

TOP text

The user guide displays four fields-red, green, yellow and blue at the bottom of the screen. The yellow field denotes the next group and the blue field indicates the next block.

Group/block/page selection

1. With the **BLUE** button you can progress from block to block.
2. Use the **YELLOW** button to proceed to the next group with automatic overflow to the next block.
3. With the **GREEN** button you can proceed to the next existing page with automatic overflow to the next group. Alternatively the **PR▲** button can be used.
4. The **RED** button permits to return to previous selection. Alternatively the **PR▼** button can be used.

FLOF text

The Teletext pages are colour coded along the bottom of the screen and are selected by pressing the corresponding coloured button.





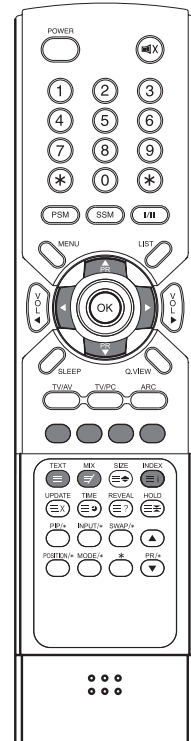



Page selection

1. Press the **INDEX** button to select the index page.
2. You can select the pages, which are colour coded along the bottom line with the same coloured buttons.
3. The **◀▶** button can be used to select the preceding or following page.



TELETEXT

Special TELETEXT functions

MENU		Functions
	TEXT	Changes Teletext mode
	SIZE	Selects double height text. Press this button to enlarge the top half of the page. Press this button again to enlarge the bottom half of the page. Press this button again to return to the normal display.
	HOLD	Stops the automatic page change, which will occur if a Teletext page consists of 2 or more sub pages. The number of sub pages and the sub page displayed is, usually, shown on the screen below the time. When this button is pressed the stop symbol is displayed at the top left-hand corner of the screen and the automatic page change is inhibited. To continue press this button again.
	INDEX	Return to index page
	UPDATE	Displays the TV picture on the screen while waiting for the new Teletext page. The display will appear at the top left hand corner of the screen. When the updated page is available then display will change to the page number. Press this button to view the updated Teletext page.
	TIME	When viewing a TV programme, press this button to display the time at the top right hand corner of the screen. Press this button again to remove the display. In Teletext mode press this button to select and hold or change a four-digit sub page number. This is displayed along the bottom of the screen. Press this button again to exit this function.
	REVEAL	Press this button to display the concealed information, such as solutions of riddles or puzzles. Press this button again to remove the information from the display.
	MIX	Only Teletext mode, text mode superimposed on the TV picture, TV mode

External Equipment Connection

You can connect additional equipment, such as VCRs, camcorders etc. to your set. Examples are shown below.

Antenna connection

1. Connect RF out on the VCR to the Antenna input on the rear of the TV.
2. Connect the antenna cable to the antenna in jack on the VCR.
3. Press the **TV/AV** button to select Antenna Input source.
4. Press the **PLAY** button on the VCR.

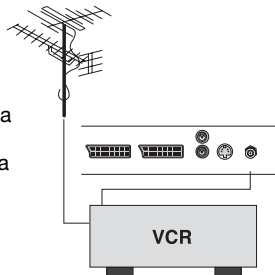

SCART 2(Half)

1. Connect the AV out jacks on the AV device to the SCART2 jack on the TV.
2. Use the **TV/AV** button to select **SCART2** mode.
3. Press the **PLAY** button on the DVD.

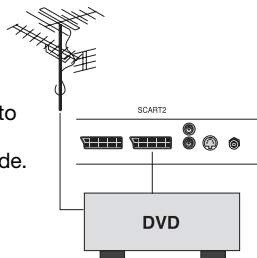

SCART 1(Full)

1. Connect the A/V out jacks on the AV device to SCART1 jack on the TV.
2. Use the **TV/AV** button to select **SCART1** mode.
3. Press the **PLAY** button on the VCR. The VCR playback picture appears on the TV screen.

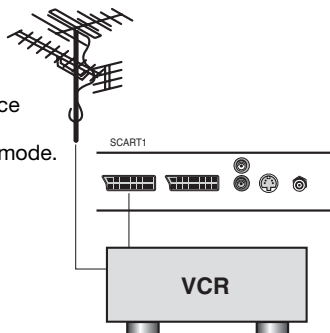

External Equipment Connection

S-VIDEO INPUT

If using an **S-VIDEO** source, the picture quality will be improved over a video source.

1. Connect the S-VIDEO output of a VCR to the **S-VIDEO** input on the TV.
2. Connect the audio cables from the S-VIDEO on the VCR to the **L (MONO), R** inputs on the TV.
3. Select **S-VIDEO** mode by pressing the **TV/AV** button repeatedly.
4. Press the **PLAY** button on the VCR.

The VCR playback picture appears on the screen.

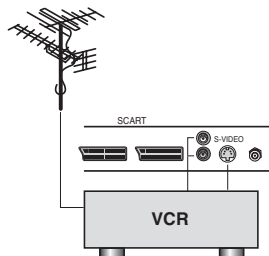

Headphone jack

Insert the headphone plug to the headphone jack on the TV. You can listen to the sound through the headphone; no sound from the speaker on the TV. To adjust the headphone volume, press the **◀▶** button. If you press the **MUTE** (🔇) button, the sound from the headphone is turned off.

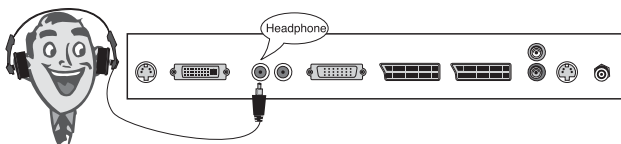

Model:LT-30FLF
/LT-30HLF

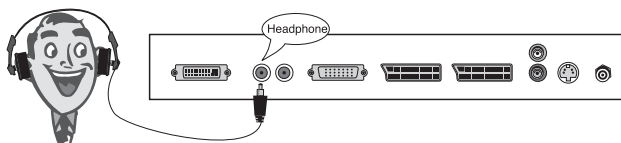

Model:LT-32HLF

Connecting the PC as a monitor

This function is possible only when the set is in PC mode. Use the **TV/AV** button on remote controller.

Picture adjustment

You can adjust picture **Contrast, Brightness, Temperature, Clock, Phase** and **ARC** as you prefer.

1. Press the **TV/AV** button to select the PC mode.
2. Press the **MENU** button.
3. Select the **Picture**.
4. Press the **PR** ▲ ▼ button to select the desired picture item.
5. Press the ◀ ▶ button to make appropriate adjustments.
6. Press the **TV/AV** button to exit menu.

Contrast

This function is to adjust **picture** to light/dark.

Brightness

This function is to adjust **brightness** of picture.

Temperature

Temperature is a measure of the warmth of the image color.

Note. Press the PSM button to switch Temperature directly.

Clock

This function is to minimize any vertical bars or stripes visible on the screen background. And the horizontal screen size will also change.

Note : This mediation range is different according to the supported resolution.

Phase

This function allows you to remove any horizontal noise and clear or sharpen the image of characters.

ARC (Aspect Ratio Control)

Selects a screen mode.-4:3 or 16:9

- * 4:3 mode : Sets the picture to 4:3 normal mode.
- * 16:9 mode : Sets the picture to 16:9 wide mode.



4 : 3



16 : 9

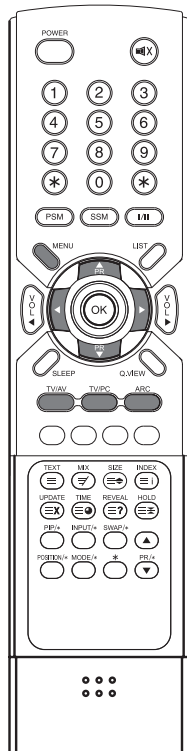
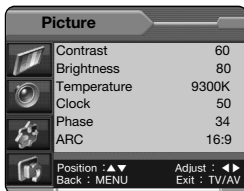
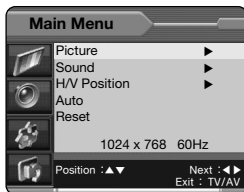

Connecting the PC as a monitor

Sound adjustment

1. Press the **MENU** button.
2. Select the **Sound** menu.
3. Press the **PR ▲ ▼** button to select the desired sound item; **Equalizer**, **Balance**, **AVL**, **Surround**, **Sound Mode** or **Input**.
4. Press the **◀▶** button to make desired adjustment.
5. Press the **◀▶** button in **Equalizer** to set the **Equalizer**.
6. Press the **PR ▲ ▼** button to select your preferred setting ; **Flat**, **Music**, **Movie**, **Speech** or **User**.
To set the Equalizer User.
 - a. Select **User** by pressing the **PR ▲ ▼** button.
 - b. Select a sound band by pressing the **◀▶** button.
 - c. Make appropriate sound level with the **PR ▲ ▼** button.
 - d. Press the **MENU** button to return to preceding menu.
7. Press the **PR ▲ ▼** button to the **Balance** menu.
8. Select the Balance menu with the **◀▶** button and adjust the balance of speaker.
9. Select the **AVL**(Automatic Volume Leveler) menu **ON** or **OFF**.
10. Select the **Surround** menu **ON** or **OFF**.
11. Select the **Sound Mode** with **PR ▲ ▼** button.
12. Press the **◀▶** button to select sound mode – **L+R**, **L+L**, **R+R**.

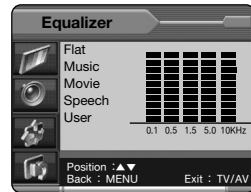

L+R : Audio signal from audio L input is sent to left loudspeaker and audio signal from audio R input is sent to right loudspeaker.

L+L : Audio signal from audio L input is sent to left and right loudspeakers.

R+R : Audio signal from audio R input is sent to left and right loudspeakers.

13. Select the **Input** with **PR ▲ ▼** button.
14. Press the **◀▶** button to select Input – **PC**, **Radio**.
In PIP mode, you can select **PC** or **PIP** Input.
When selecting **Radio** input, convert sound of radio to sound of PIP in PIP mode.
Note:
 - a. When selecting radio mode, sound mode alternates between **MONO** and **STEREO** according to the received signal.
 - b. In **PC** mode, radio mode supports only **Auto**.
 - c. In **PC** mode, radio mode function is on an equality with Radio function in the front.(See page 20)

Connecting the PC as a monitor

Position Adjustment

This function is to adjust picture to left/right and up/down as you prefer.

1. Press the **MENU** button.
2. Select the **H/V Position** menu.
3. Press the **PR ▲ ▼** button to select the desired position item.
4. Press the **◀▶** button to adjust horizontal position and vertical position.
5. Press the **TV/AV** button to exit menu

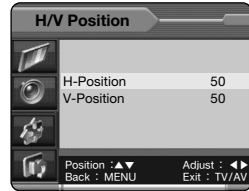

Auto

This function is for the automatic adjustment of the screen position, clock and clock phase. The displayed image will disappear for a few seconds while the Auto-configuration is in process.

Note: Some signal from some graphics boards may not function properly.
If the results are unsatisfactory, adjust your monitor's position, clock and clock phase manually.

Reset

This function allows you to return to the good picture reproduction programmed at the factory and cannot be changed.

Connecting the PC as a monitor

PC INPUT

1. Connect the PC IN cable (D-sub jack) from the monitor output socket of the PC to the PC ANALOG input socket of the set.
2. Connect the PC Audio IN cable from the PC to the **PC AUDIO IN** of the set.
3. Press the **TV/AV** or **TV/PC** button to select **PC Analog** mode.
4. Switch on the PC, and the PC screen appears on the set. The set can be operated as the PC monitor.

Model:LT-30FLF/LT-30HLF

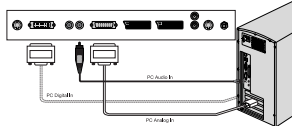

Model:LT-32HLF

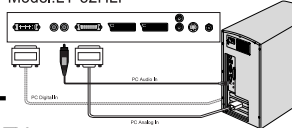

DVI (Digital Visual Interface) INPUT

1. Connect the DVI of PC to the PC Digital input on the TV.
2. Select PC-Digital mode by pressing the TV/AV button repeatedly. (When DVI source is connected, TV/AV mode converts PC to DVI mode.)

Resolution

Mode	Resolution	Horizontal frequency(KHz)	Vertical frequency(Hz)
VGA	640 x 480	31.5 KHz	60 Hz
	640 x 480	37.9 KHz	72 Hz
	640 x 480	37.5 KHz	75 Hz
	720 x 400	31.4 KHz	70 Hz
SVGA	800 x 600	35.1 KHz	56 Hz
	800 x 600	37.9 KHz	60 Hz
	800 x 600	48.1 KHz	72 Hz
	800 x 600	46.9 KHz	75 Hz
XGA	1024 x 768	48.4 KHz	60 Hz
	1024 x 768	56.5 KHz	70 Hz
	1024 x 768	60.0 KHz	75 Hz
WXGA	1280 x 768	47.4 KHz	60Hz RB
	1280 x 768	47.8 KHz	60 Hz
DTV	720 x 480p	31.5 KHz	60 Hz
	720 x 576p	31.2 KHz	50 Hz
	1280 x 720p	45.0 KHz	60 Hz
	1280 x 720p	37.5 KHz	50 Hz
	1920 x 1080i	33.7 KHz	60 Hz
	1920 x 1080i	28.1 KHz	50 Hz

Note:

- a. If the set is cold, there may be a small "flicker" when the set is switched on. This is normal, there is nothing wrong with the set.
- b. Some dot defects may appear on the screen, like Red, Green or Blue spots. However, this will have no impact or effect on the monitor performance.
- c. The resolution which is not supported will appear at the resolution which gets near to the resolution which is supported
 - * The standard of the resolution which gets near : H/V sync.
- d. Press the Q.VIEW button to switch the 640x480 60Hz to 720x480P 60Hz.

Product Specification

Model	LT-30FLF	LT-30HLF		
Main body	Horizontal size	850mm	Horizontal size	850mm
	Thickness	210mm	Thickness	210mm
	Height	485mm	Height	485mm
	Weight	15kg	Weight	15.64 kg
Power requirements	DC 24V/6.0A			
Television system	PAL-BG, I, DK / SECAM-BG, DK, L / AV NTSC			
Television programme	VHF: 2~12 UHF :21~69 Cable : S1~S41			
LCD Panel	30" WIDE TFT LCD panel			
Resolution	WXGA(1280 X 768)			
Power consumption	140W			
External antenna impedance	75Ω			
Audio output	10W + 10W			
External input ports	<ul style="list-style-type: none"> • DC 24V IN • HEADPHONE OUT • PC Analog IN • S-VIDEO • SCART 1 • PC Digital IN • PC/DVI-AUDIO IN • SCART 2 • ANTENNA 			
AC/DC Power Adaptor	100-240Va.c. 50/60Hz Output : 24Vd.c., 6.0A			

Model	LT-32HLF			
Main body	Horizontal size	930(930)mm	Thickness	112(210)mm
	Height	503(560)mm	Weight	17.6(19.3) kg
Television system	PAL-BG, I, DK / SECAM-BG, DK, L / AV NTSC			
Television programme	VHF: 2~12 UHF :21~69 Cable : S1~S41			
LCD Panel	32" WIDE TFT LCD panel			
Power consumption	150W			
External antenna impedance	75Ω			
Audio output	10W + 10W			
External input ports	<ul style="list-style-type: none"> • PC Digital IN • PC/DVI-AUDIO IN • SCART 1 • S-VIDEO • HEADPHONE OUT • PC Analog IN • SCART 2 • ANTENNA 			
AC Input	100-240Va.c. 50/60Hz			

Troubleshooting

Problem	Check item
No picture on screen and no sound from speakers	<ul style="list-style-type: none"> • Insert the AC power cord plug securely in AC power outlet. • Make sure the set is not in the standby mode (The POWER/Standby indicator is red.)
No picture/No picture from AV terminal	<ul style="list-style-type: none"> • Check the brightness setting of the display. • Lamp may have malfunction. • Make sure a cable with no VIDEO input signal is connected to the S-VIDEO INPUT terminal.
Picture is displayed, but no sound from the speakers.	<ul style="list-style-type: none"> • Check the sound setting. • Make sure the sound is not muted. • Make sure a pair of headphones is not connected. • Make sure the connectors of the optional speaker system are securely inserted.
Picture is too light	<ul style="list-style-type: none"> • Make sure COLOR and CONTRAST settings.
Picture is too dark.	<ul style="list-style-type: none"> • Make sure BRIGHTNESS setting is not set too low. • Lamp may have malfunction.
Remote control does not work.	<ul style="list-style-type: none"> • Change the batteries. • Make sure the infrared transmitter window is not receiving strong light such as light from fluorescent lamps.
The picture is not sharp. The picture moves.	<ul style="list-style-type: none"> • The reception may be weak. • The state of the broadcast may also be bad. • Make sure the antenna is facing the right direction. • Make sure the outside antenna is not disconnected.
The picture is doubled or tripled.	<ul style="list-style-type: none"> • Make sure the antenna is facing the right direction. • There may be reflected electric waves from mountains or buildings.
The picture is spotted.	<ul style="list-style-type: none"> • There may be interference from automobiles, trains, high voltage lines, neon lights, etc. • There may be interference between the antenna cable and power cable. Try positioning them further apart.
There are stripes on the screen or colors fade.	<ul style="list-style-type: none"> • Is the unit receiving interference from other devices? Transmission antennas of radio broadcasting stations and transmission antennas of amateur radios and cellular phones may also cause interference. • Use the unit as far apart as possible from devices that may cause possible interference.

Limited Warranty
