

ROPER[®]
Home Appliances

Use And Care

G U I D E

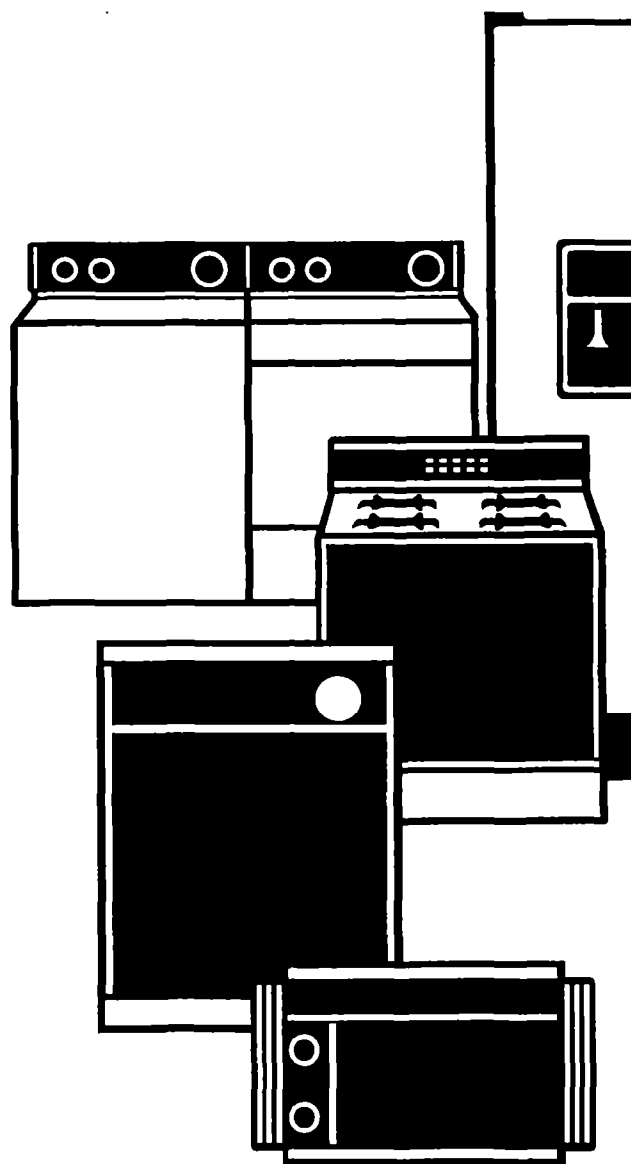

Table Of Contents	
(complete)	2
A Note To You	2
Refrigerator Safety	3
Parts And Features	4
Before Using Your Refrigerator	6
Using Your Refrigerator	9
Attaching the optional ice maker to a water supply	17
Reversing the door swing	22
Caring For Your Refrigerator	24
Food Storage Guide ...	28
Troubleshooting	30
Requesting Assistance Or Service	31
Warranty	32

1-800-44-ROPER

Call us with questions or comments.

NO-FROST TOP-FREEZER REFRIGERATOR

PART NO. 2193498

6196

Table Of Contents

A Note To You	2	Using the optional automatic ice maker	16
Refrigerator Safety	3	Attaching the optional ice maker to a water supply	17
Parts And Features	4	Removing the base grille	19
Before Using Your Refrigerator	6	Changing the light bulbs	20
Cleaning your refrigerator	6	Understanding the sounds you may hear	21
Installing it properly	6	Saving energy	21
Plugging it in	7	Reversing the door swing	22
Leveling it	8	Caring For Your Refrigerator	24
Using Your Refrigerator	9	Cleaning your refrigerator	24
Setting the controls	9	Vacation and moving care	26
Changing the control settings	10	Power interruptions	27
Removing the drop-in door trim pieces	11	Food Storage Guide	28
Removing the snap-on door trim	11	Storing fresh food	28
Using the flip-up door shelf	11	Storing frozen food	29
Adjusting the refrigerator shelves	12	Troubleshooting	30
Removing the meat drawer and cover	13	Requesting Assistance Or Service	31
Removing the crispers and crisper cover	14	Warranty	32
Adjusting the crisper cover track	14		
Adjusting the freezer shelf	15		

A Note To You

Thank you for buying a ROPER® appliance.

ROPER appliances give you all the functionality of name brand appliances at a value price. To ensure you enjoy years of trouble-free operation, we developed this Use and Care Guide. It contains valuable information about how to operate and maintain your appliance properly and safely. Please read it carefully. Also, please complete and mail the Ownership Registration Card provided with your appliance. This card helps us notify you about any new information on your appliance.

Please record your model's information.

Whenever you call to request service on your appliance, you need to know your complete model number and serial number. You can find this information on the model and serial number label (see diagrams on pages 4 and 5 for location of label).

Please also record the purchase date of your appliance and your dealer's name, address, and telephone number.

Model Number _____
 Serial Number _____
 Purchase Date _____
 Dealer Name _____
 Dealer Address _____
 Dealer Phone _____

Keep this book and the sales slip together in a safe place for future reference.

Refrigerator Safety

Your safety is important to us.

This guide contains statements under warning symbols. Please pay special attention to these symbols and follow any instructions given. Here is a brief explanation of the use of the warning symbol.



This symbol alerts you to hazards such as fire, electrical shock, or other injuries.

IMPORTANT SAFETY INSTRUCTIONS

! WARNING

To reduce the risk of fire, electrical shock, or injury when using your refrigerator, follow these basic precautions:

- Read all instructions before using the refrigerator.
- Never allow children to operate, play with, or crawl inside the refrigerator.
- Never clean refrigerator parts with flammable fluids. The fumes can create a fire hazard or explosion.

• FOR YOUR SAFETY •

DO NOT STORE OR USE GASOLINE OR OTHER FLAMMABLE VAPORS AND LIQUIDS IN THE VICINITY OF THIS OR ANY OTHER APPLIANCE. THE FUMES CAN CREATE A FIRE HAZARD OR EXPLOSION.

– SAVE THESE INSTRUCTIONS –

Proper disposal of your old refrigerator

! WARNING

Suffocation Hazard

Remove doors from your old refrigerator.

Failure to do so can result in death or brain damage.

IMPORTANT: Child entrapment and suffocation are not problems of the past. Junked or abandoned refrigerators are still dangerous ... even if they will sit for "just a few days." If you are getting rid of your old refrigerator, please follow the instructions below to help prevent accidents.

BEFORE YOU THROW AWAY YOUR OLD REFRIGERATOR OR FREEZER:

- Take off the doors.
- Leave the shelves in place so that children may not easily climb inside.

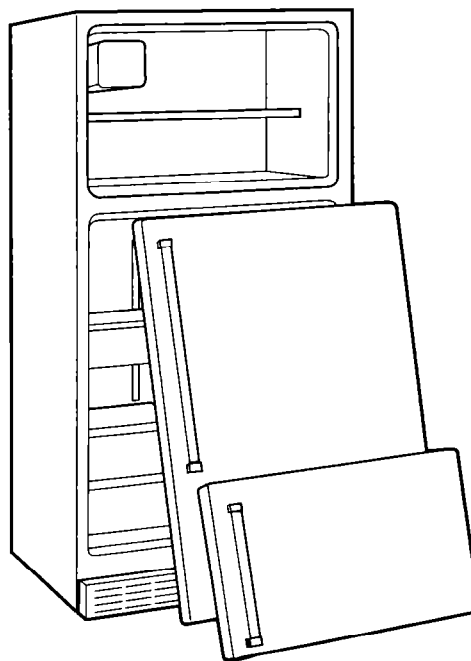

Parts And Features

Below are illustrations of your appliance with the parts and features called out. To help you find information on specific parts or features faster, page references are included.

NOTE: The model you purchased may have all or some of the parts and features shown and they may not match the illustrations exactly. This manual covers several models.

Control panel (all models)

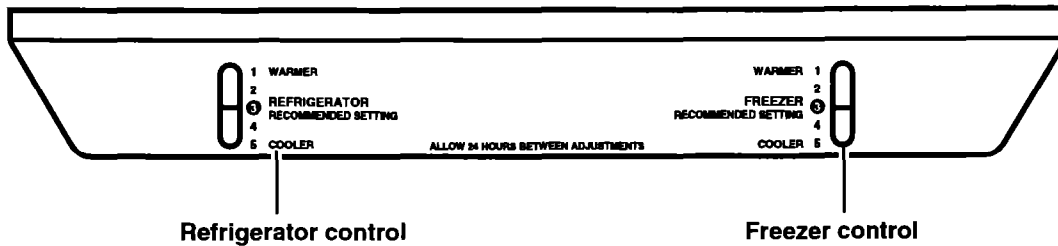

STYLE 1

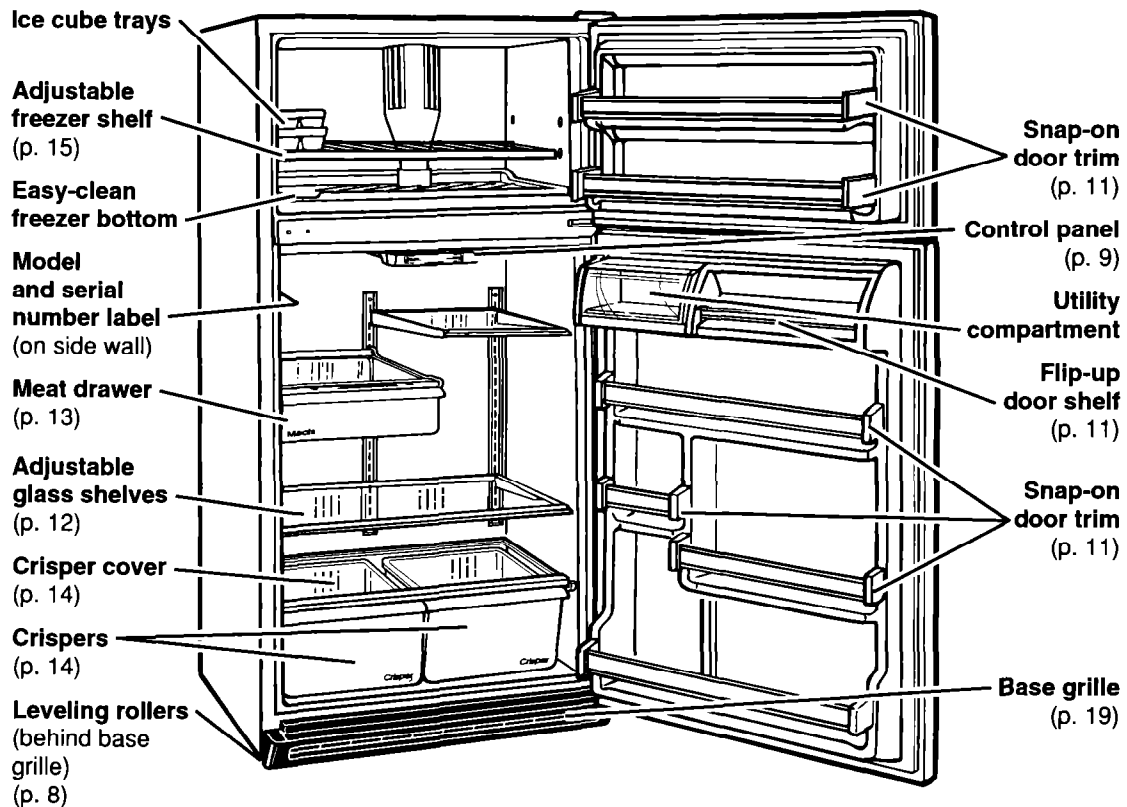

STYLE 2

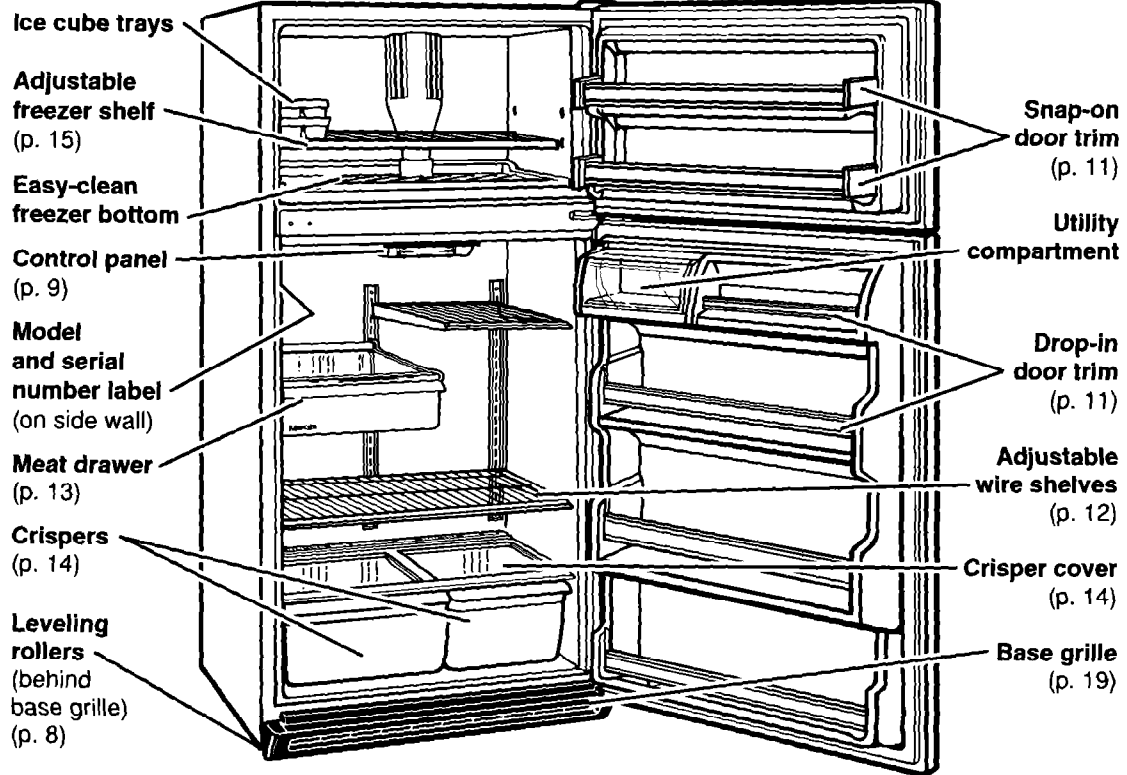

STYLE 3

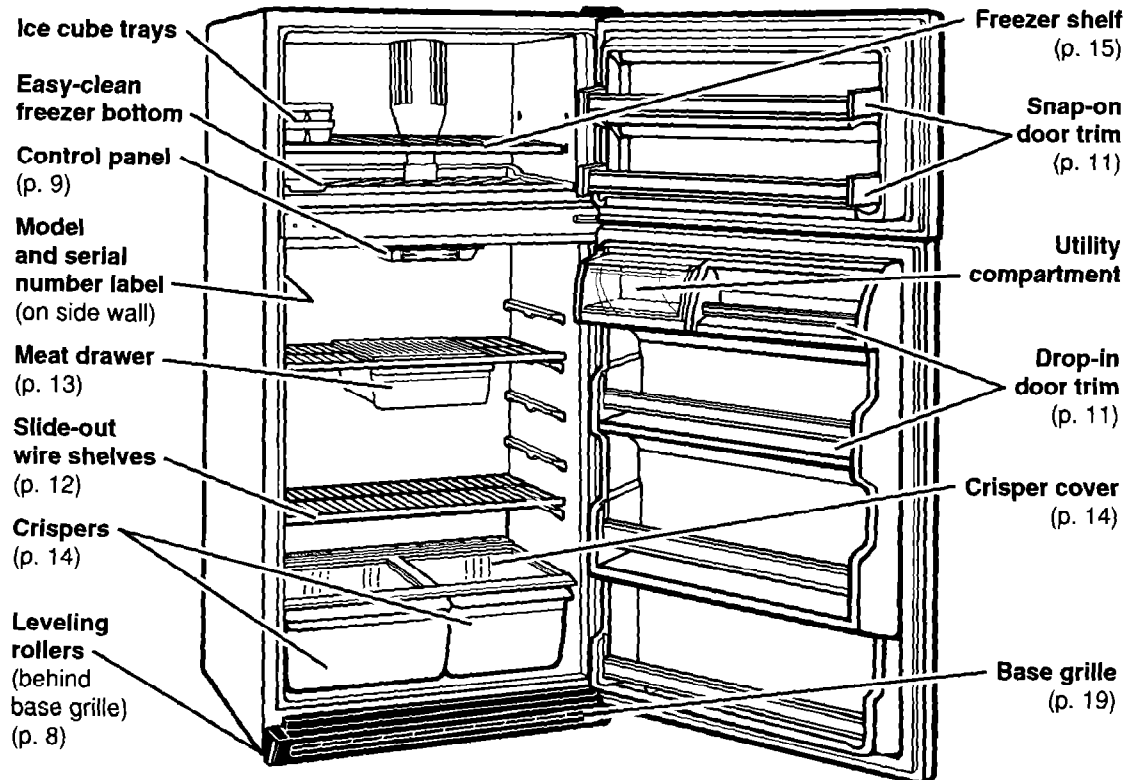

Before Using Your Refrigerator

It is important to prepare your refrigerator for use. This section tells you how to clean it, install it, connect it to a power source, and level it.

Cleaning your refrigerator

Removing packaging materials

Remove tape and any inside labels (except the model and serial number label) before using the refrigerator.

To remove any remaining glue:

- Rub briskly with thumb to make a ball, then remove.

OR

- Soak area with liquid hand dishwashing detergent before removing glue as described above. Do not use sharp instruments, rubbing alcohol, flammable fluids, or abrasive cleaners. These can damage the material. See "Important Safety Instructions" on page 3.

NOTE: Do not remove any permanent instruction labels inside your refrigerator. Do not remove the Tech Sheet fastened under the refrigerator at the front.

Cleaning it before use

After removing all packaging materials, clean your refrigerator before using it, if necessary. See cleaning instructions on pages 24-25.



Installing it properly

1. Allow ½ inch (1.25 cm) space on each side and at the top of the refrigerator for ease of installation.
2. If the hinge side of the refrigerator is to be against a wall, you might want to leave extra space so the door can be opened wider.
3. The refrigerator can be flush against the back wall.

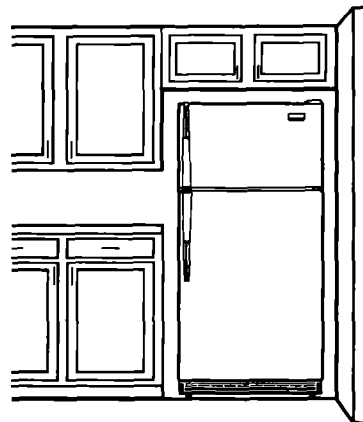

Plugging it in

⚠ WARNING



Fire Hazard

**Do not use an extension cord.
Doing so can result in death, fire,
or electrical shock.**

⚠ WARNING



Electrical Shock Hazard

**Plug into a grounded 3 prong outlet.
Do not remove ground prong.
Do not use an adapter.
Failure to follow these instructions
can result in death or electrical shock.**

Recommended Grounding Method

A 115 Volt, 60 Hz., AC only 15 or 20 ampere fused and properly grounded electrical supply is required. It is recommended that a separate circuit serving only this appliance be provided. Use a receptacle which cannot be turned off with a switch or pull chain. Do not use an extension cord.

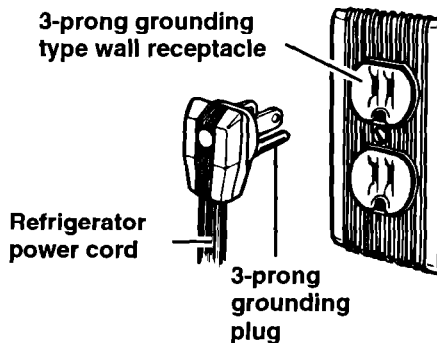

Leveling it

⚠ WARNING



Burn Hazard

Do not touch refrigeration tubes near defrost pan.

Doing so can result in burns.

Your refrigerator has 2 front leveling screws – one on the right and one on the left. To adjust one or both of these, follow the directions below.

1. Remove base grille. (See page 19.)
2. To raise front, turn screw clockwise.
3. To lower front, turn screw counterclockwise.
4. Check with level.
5. Replace base grille. (See page 20.)

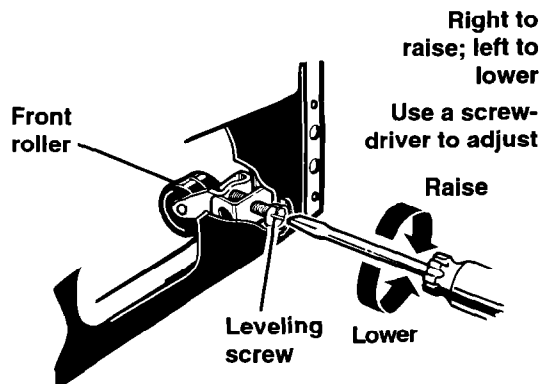

Using Your Refrigerator

To obtain the best possible results from your refrigerator, it is important that you operate it properly. This section tells you how to set the controls, remove and adjust some of the features in your refrigerator, and how to save energy.

Setting the controls

Controls for the refrigerator and freezer are in the refrigerator. When you plug in the refrigerator for the first time:

1. **Set the Refrigerator Control to 3 (Recommended Setting).** Refrigerator Control settings range from 1 (warmer) to 5 (cooler).

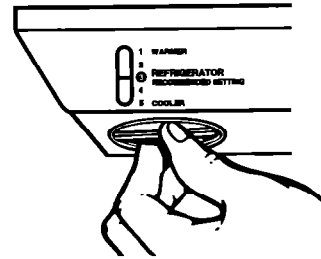

2. **Set the Freezer Control to 3 (Recommended Setting).** Freezer Control settings range from 1 (warmer) to 5 (cooler).
3. Give the refrigerator time to cool down completely before adding food. This may take several hours.

The settings indicated above should be correct for normal, household refrigerator usage. The controls are set correctly when milk or juice is as cold as you like and when ice cream is firm. If you need to adjust these settings, see "Changing the control settings" on page 10.

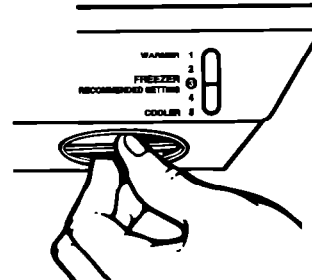





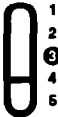
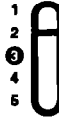
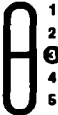
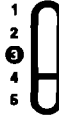

USING YOUR REFRIGERATOR

Changing the control settings

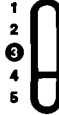
If you need to adjust temperatures in the refrigerator or freezer, use the settings listed in the chart below as a guide. If you have questions, call us at **1-800-447-6737**.

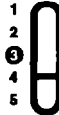
- Adjust the Refrigerator Control first.
- Wait at least 24 hours between adjustments.
- Then adjust the Freezer Control if needed.

CONDITION:	REASON:	RECOMMENDED CONTROL SETTINGS:	
		Refrigerator	Freezer
Refrigerator section too warm	<ul style="list-style-type: none"> • Door opened often • Large amount of food added • Room temperature too warm 		
Freezer section too warm	<ul style="list-style-type: none"> • Door opened often • Large amount of food added • Very cold room temperature (can't cycle often enough) 		
Refrigerator section too cold	<ul style="list-style-type: none"> • Controls not set correctly for your conditions 		
Ice not made fast enough	<ul style="list-style-type: none"> • Heavy ice usage • Very cold room temperature (can't cycle often enough) 		
Both sections too warm	<ul style="list-style-type: none"> • Door opened often • Large amount of food added • Very warm or very cold room temperatures 		

USING YOUR REFRIGERATOR

Removing the drop-in door trim pieces

To remove the trim piece:

1. Remove all items from the shelf.
2. Pull straight up on the trim piece at each end.



To replace the trim piece:

1. Locate each end of the trim piece above the trim pocket opening.
2. Push the trim piece straight down until it stops.
3. Replace items on the shelf.



Removing the snap-on door trim

To remove the trim piece:

1. Remove all items from the shelf.
2. Pull out on the inside tab at each end of the trim piece.
3. Lift trim piece straight out.

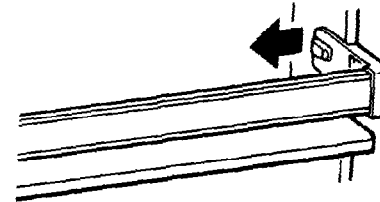

To replace the trim piece:

1. Line up ends of the trim piece with the button on the door liner wall.
2. Push trim piece straight back until it snaps securely into place.
3. Replace items on the shelf.

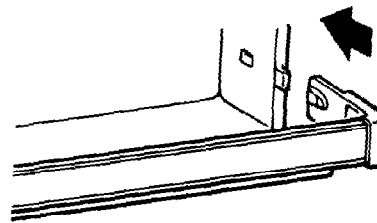

Using the flip-up door shelf (on some models)

The shelf bottom flips up so you can store taller items in the door shelf below. When in the down position, the shelf is strong enough to hold up to 10 pounds.

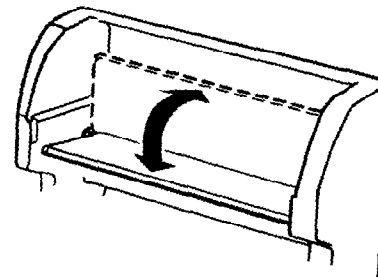

Adjusting the refrigerator shelves

Adjust the shelves to match the way you use your refrigerator.

NOTE: Glass shelves are strong enough to hold bottles, milk, and other heavy food items.

Slide-out wire shelves

To remove the shelves:

1. Remove all items from the shelf.
2. Slide shelf straight out to the stop.
3. Lift the front slightly.
4. Slide shelf out the rest of the way.

To replace the shelves:

1. Fit back of shelf on top of guide with wire stops on the bottom of the guide.
2. Lift the front.
3. Slide shelf in until it clears all stops.

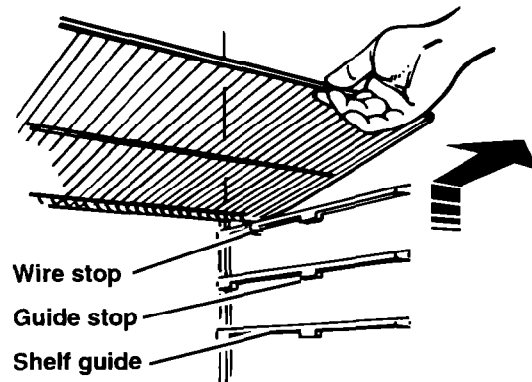

Cantilever glass or wire shelves

To remove glass or wire shelves:

1. Remove items from shelf.
2. Tilt shelf up at front.
3. Lift back of shelf.
4. Pull shelf straight out.

To replace glass or wire shelves:

1. Guide the rear shelf hooks into the slots in the shelf supports on the cabinet wall.
2. Tilt shelf up at front until hooks drop into slots. Lower front of shelf to level position.

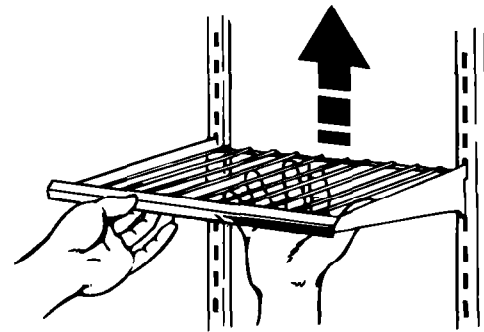

NOTE: Glass shelves are heavy. Be careful.

Removing the meat drawer and cover

Remove the meat drawer and cover for easier cleaning.

Style 1

To remove the meat drawer:

1. Slide meat drawer out to the stop.
2. Lift the front of the meat drawer.
3. Slide meat drawer out the rest of the way.
4. Replace in reverse order.

To remove the cover:

1. Remove meat drawer.
2. Push cover back to release the rear of the cover from the shelf.
3. Tilt cover up at the front.
4. Pull cover forward and out.

To replace the cover:

1. Fit notches and rear edge of cover over rear and center crossbars on the shelf.
2. Lower cover into place.
3. Replace the meat drawer.

Style 2

To remove the meat drawer:

1. Slide meat drawer out to the stop.
2. Lift front of meat drawer.
3. Slide meat drawer out the rest of the way.
4. Replace in reverse order.

To adjust the cover position:

1. Tilt front of cover up.
2. Lift back of cover.
3. Pull cover straight out.

To replace the cover:

1. Guide the cover's rear hooks into the slots in the shelf supports on the cabinet wall.
2. Tilt cover up at the front until the hooks drop into the slots.
3. Lower front of cover to a level position and replace meat drawer.

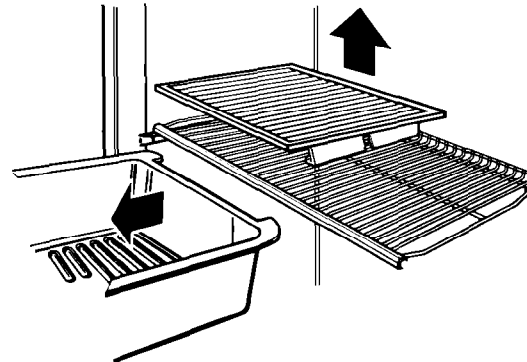

Remove meat drawer before cover.

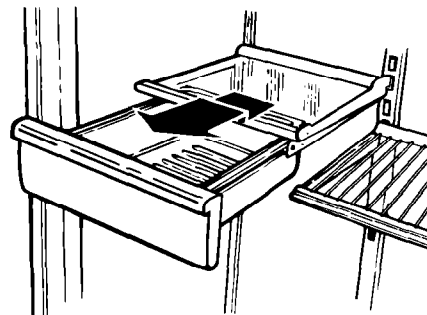

Pull out to the stop,
lift the front and pull again.

Removing the crispers and crisper cover

To remove the crispers:

1. Slide crisper straight out to the stop.
2. Lift the front.
3. Slide out the rest of the way.
4. Replace in reverse order.

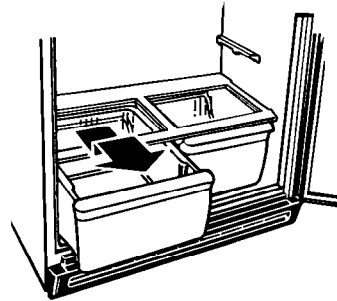

Pull out to the stop, lift the front and pull again.

To remove the cover:

1. Push up the cover insert from the bottom, then slide out with both hands.
2. Lift front of cover frame.
3. Lift cover frame up and out.

To replace the cover:

1. Fit back of cover frame into notch supports on back wall of refrigerator, then lower the front into place.
2. Slide back of cover insert into place, then lower the front.

Remove the cover insert. Lift the cover front, then the back.

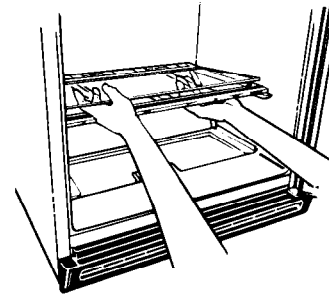

NOTE: Handle glass insert with care. It could be heavy.

Adjusting the crisper cover track

(on some models)

For your convenience, one crisper may be larger than the other, and your crisper cover may have an adjustable center track so you can switch positions of the crispers. This allows you to store celery and other longer items in a crisper. You can adjust the cover center track with the cover in the refrigerator by removing the crispers and the cover insert.

To remove the center track:

1. Push up the cover insert from the bottom, then slide out with both hands.
2. Gently pull up on front end of track.
3. Pull rear end of track out of opening in cover.

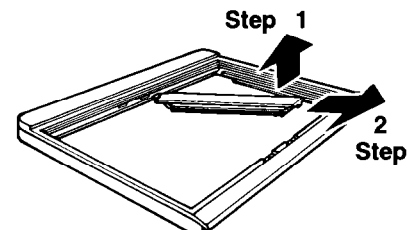

To replace the center track:

1. Insert rear end of track (with hole) into opening in cover.
2. Lower front end of track into slot.
3. Make sure rear end of track has snapped into place on underside of cover.

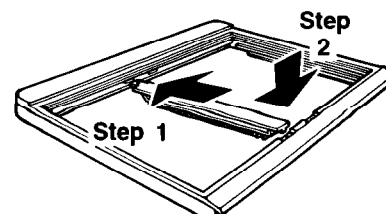

Adjusting the freezer shelf

(on some models)

Adjust the freezer shelf to match the way you use your freezer.

To remove the shelf:

1. Lift entire shelf slightly.
2. Move shelf all the way to one side.
3. Tilt other side up and out of shelf support cups.
4. Pull shelf up and out.

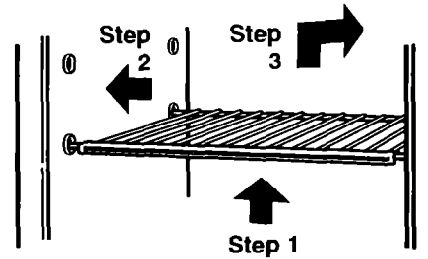

To replace the shelf:

1. Tilt the shelf and insert into freezer compartment.
2. Insert one end of the shelf all the way into the center of the shelf support cups.
3. Lower other end of shelf and insert into the shelf support cups.
4. Lower shelf into place.

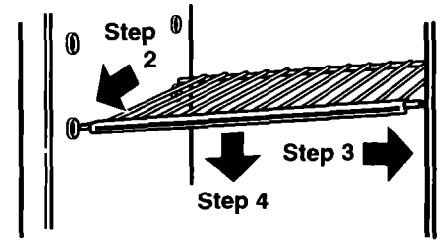

NOTE: The shelf should lower slightly and lock into place. If the shelf does not appear sturdy, make sure both ends of the shelf are inserted into the shelf support cups.

Using the optional automatic ice maker

If your refrigerator has an automatic ice maker, or if you plan to add one later, here are a few things you will want to know.

- The ON/OFF lever is a wire signal arm.

DOWN to make ice automatically
UP to shut off ice maker

IMPORTANT: Do not turn the ice maker ON until it is connected to a water supply.

- If you remove the ice bin, raise the signal arm to the OFF position. When you replace the bin, push it all the way in and lower the signal arm to the ON position.
- Good water quality is important for good ice quality. Try to avoid connecting the ice maker to a softened water supply. Water softener chemicals (such as salt from a malfunctioning softener) can damage the ice maker mold and lead to poor ice quality. If a softened water supply cannot be avoided, make sure the water softener is operating properly and is well maintained.

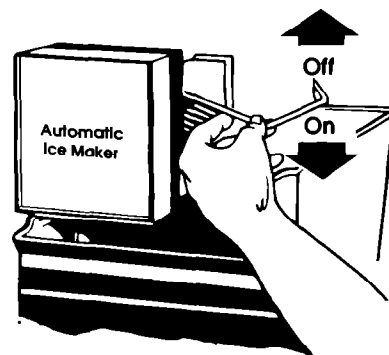

UP to
stop ice
maker

DOWN to
start ice
maker

Solving common ice maker problems

PROBLEM	POSSIBLE CAUSE/SOLUTION
Ice crescents attached at corners	<ul style="list-style-type: none"> • This is normal. They break apart easily. Shake bin occasionally to keep cubes separated.
Ice maker will not operate or ice is not made fast enough	<ul style="list-style-type: none"> • ON/OFF lever is in the OFF (up) position. Lower lever to the ON (down) position. • Freezer is not cold enough. Adjust temperature controls and wait 24 hours. (See "Changing the control settings" on page 10.)
Off-taste or odor in ice	<ul style="list-style-type: none"> • New plumbing connections can cause discolored or off-flavored ice. Discard the first few batches of ice. • Cubes are stored too long. Throw them away and make a new supply. • Foods in freezer are not wrapped properly. See "Food Storage Guide" on page 28. • Freezer and ice bin need to be cleaned. See pages 24 and 25.

Attaching the optional ice maker to a water supply

Read all directions carefully before you begin

⚠ WARNING



Electrical Shock Hazard
Unplug the refrigerator before installing ice maker.
Failure to do so can result in death or electrical shock.

NOTE: Your appliance dealer has a kit available with a ¼-inch saddle-type shut-off valve, a union, and copper tubing. Before purchasing, make sure a saddle-type valve complies with your local plumbing codes. Do not use piercing-type or ⅜-inch saddle valve which reduces water flow and clogs more easily.

Cold water supply

The ice maker water valve contains a flow washer which is used as a water pressure regulator. The ice maker needs to be connected to a cold water line with water pressure limitations of 20-120 psi. If a problem occurs, call your utility company.

IMPORTANT:

- Use copper tubing only and check for leaks.
- Install ice maker tubing in areas where temperatures are above freezing.

Tools required:

- Standard screwdriver
- 7/16-inch and 1/2-inch open-end wrenches or two adjustable wrenches
- 1/4-inch nut driver
- 1/4-inch drill bit
- Hand drill or electric drill (properly grounded)

IMPORTANT:

- It may take up to 24 hours for your ice maker to begin producing ice.
- If operating the refrigerator before installing the water connection, turn ice maker to the OFF position to prevent operation without water.
- All installations must be in accordance with local plumbing code requirements.

Installation is not warranted by refrigerator or ice maker manufacturer.

USING YOUR REFRIGERATOR

Connecting to water line

1. Find a 1/2-inch to 1 1/4-inch vertical COLD water pipe near the refrigerator.

NOTE: Horizontal pipe will work, but the following precaution must be taken: Drill on the top side of the pipe, not the bottom. This will help keep water away from the drill. This also keeps normal sediment from collecting in the valve.

2. Measure from connection on rear of refrigerator to water pipe. Add 7 feet (2.1 m) to allow for moving refrigerator for cleaning. This is the length of 1/4-inch O.D. copper tubing you will need for the job (length from connection to water pipe PLUS 7 feet [2.1 m]). Be sure both ends of copper tubing are cut square.
3. Turn OFF main water supply. Turn ON nearest faucet long enough to clear line of water.
4. Using a grounded drill, drill a 1/4-inch hole on the cold water pipe you have selected.
5. Fasten shut-off valve to cold water pipe with pipe clamp. Be sure outlet end is solidly in the 1/4-inch drilled hole in the water pipe and that washer is under the pipe clamp. Tighten packing nut. Tighten the pipe clamp screws carefully and evenly so washer makes a watertight seal. Do not overtighten or you may crush the copper tubing, especially if soft (coiled) copper tubing is used. Now you are ready to connect the copper tubing.
6. Slip compression sleeve and compression nut on copper tubing as shown in diagram. Insert end of tubing into outlet end squarely as far as it will go. Screw compression nut onto outlet end with adjustable wrench. Do not overtighten. Turn ON main water supply and flush out tubing until water is clear. Turn OFF shut-off valve on the water pipe. Coil copper tubing.

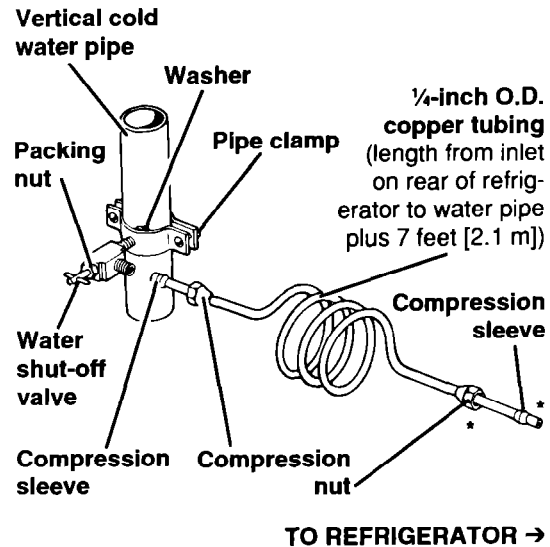

* Some models may not feature this second compression nut and sleeve.

Connecting to refrigerator

1. Disconnect the tube clamp on the back of the product and insert copper tubing through the clamp as shown at the right. Attach the copper tube to the valve inlet using a compression nut and sleeve as shown. Tighten the compression nut. Do not overtighten. Reattach the tube clamp and tube to the back of the cabinet. Move to step 2.
2. **Turn shut-off valve ON. CHECK FOR LEAKS. TIGHTEN ANY CONNECTIONS (INCLUDING CONNECTIONS AT THE VALVE) OR NUTS THAT LEAK.**
3. The ice maker is equipped with a built-in water strainer. If local water conditions require periodic cleaning or a well is your source of water supply, a second water strainer should be installed in the 1/4-inch water line. Obtain a water strainer from your nearest appliance dealer. Install at either tube connection.
4. Reconnect electrical supply to refrigerator.

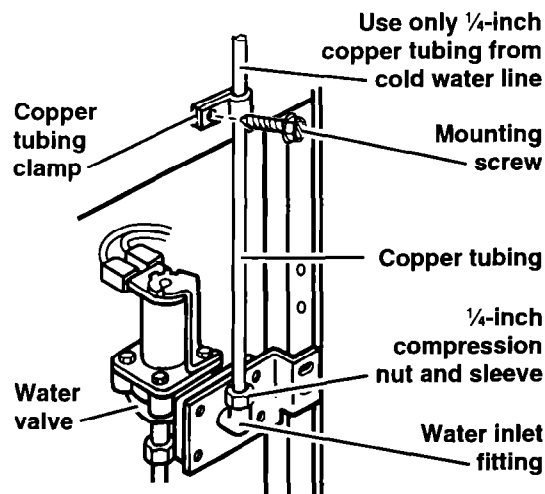

Removing the base grille

⚠ WARNING

Burn Hazard

Do not touch refrigeration tubes near defrost pan.

Doing so can result in burns.

To remove the base grille:

1. Open the refrigerator door.
2. Grasp the grille with both hands.
3. Push down on the top edge of the grille to release the top clips.
4. Roll the grille toward you to release the top clips.
5. Pull grille away from the refrigerator.

NOTE: Do not remove the Tech Sheet fastened behind the grille.

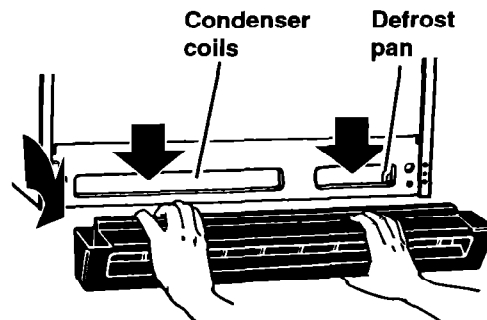

USING YOUR REFRIGERATOR

To replace the base grille:

1. Line up the edges of the grille with the outside edges of the cabinet.
2. Roll the grille toward you.
3. Place the lower clips in the openings in the metal panel.
4. Roll the grille toward the cabinet until the top clips snap into place.
5. Close the refrigerator door.

See cleaning instructions for defrost pan and condenser coils on page 25.

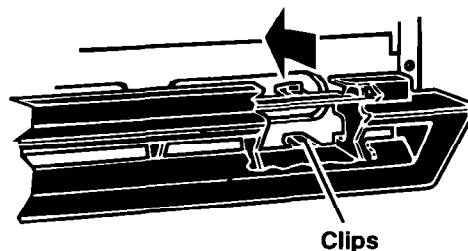

Changing the light bulbs

⚠ WARNING



Electrical Shock Hazard

Unplug the refrigerator before removing a light bulb.

Failure to do so can result in death or electrical shock.

To change refrigerator light:

1. Disconnect refrigerator from power supply.
2. Reach behind Control Panel to remove bulb.
3. Replace with a 40-watt appliance bulb.
4. Reconnect refrigerator to power supply.

NOTE: Not all commercial appliance bulbs will fit your refrigerator. Be sure to replace a bulb with one of the same size and shape.

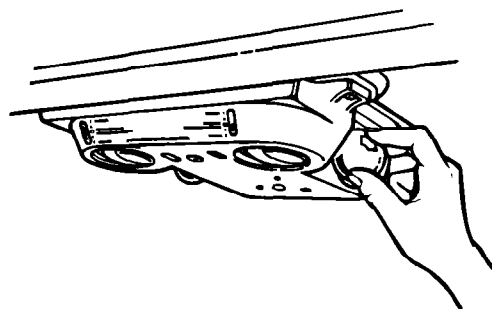

Understanding the sounds you may hear

Your new refrigerator may make sounds that your old one didn't. Because the sounds are new to you, you might be concerned about them. Don't be. Most of the new sounds are normal. Hard surfaces like the floor, walls and cabinets can make the sounds seem louder.

The following describes the kinds of sounds that might be new to you, and what may be making them.

Slight hum, soft hiss

You may hear the refrigerator's fan motor and moving air.

Clicking or snapping sounds

The thermostat makes a definite click when the refrigerator stops running. It also makes a sound when the refrigerator starts. The defrost timer will click when the defrost cycle starts.

Water sounds

When the refrigerator stops running, you may hear gurgling in the tubing for a few minutes after it stops. You may also hear defrost water running into the defrost water pan.

Ice maker sounds

- Trickling water
- Thud (clatter of ice)

You may hear buzzing (from the water valve), trickling water and the clatter of ice dumped into the bin.

Running sounds

Your refrigerator has a high-efficiency compressor and motor. It will run longer than older designs. It may even seem to run most of the time.

Saving energy

You can help your refrigerator use less electricity.

- Check door gaskets for a tight seal. Level the cabinet to be sure of a good seal.
- Clean the condenser coils regularly.
- Open the door as few times as possible. Think about what you need before you open the door. Get everything out at one time. Keep food organized so you won't have to search for what you want. Close door as soon as food is removed.
- Go ahead and fill up the refrigerator, but don't overcrowd it so air movement is blocked.
- It is a waste of electricity to set the refrigerator and freezer to temperatures colder than they need to be. If ice cream is firm in the freezer and drinks are as cold as your family likes them, that's cold enough.
- Make sure your refrigerator is not next to a heat source such as a range, water heater, furnace, radiator, or in direct sunlight.

Reversing the door swing

TOOLS NEEDED:

5/16-inch hex-head socket wrench, No. 2 Phillips screwdriver, flat-head screwdriver, 1/2-inch open-end wrench

IMPORTANT INFORMATION:

- Before you begin, turn refrigerator OFF, unplug it, and remove any food from door shelves.
- Remove base grille.
- When removing hinges, keep doors closed until ready to lift free from cabinet.
- To remove doors, start at the top hinge and work your way down.
- To remove the center hinge screws, remove the center hinge pin by turning it 1/4 to 1/2 turn. It will pop up.
- To replace doors, start at the bottom hinge and work your way up.
- Line up doors so they are centered between the sides of the cabinet and parallel with each other.
- Seal all unused openings with screws or plastic plugs. Moisture will enter any openings.
- Door seal may be adjusted by adding or removing shims to the center and bottom hinges.

Reversing the hinges

TOP HINGE

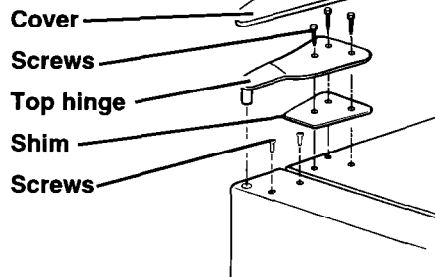

CENTER HINGE

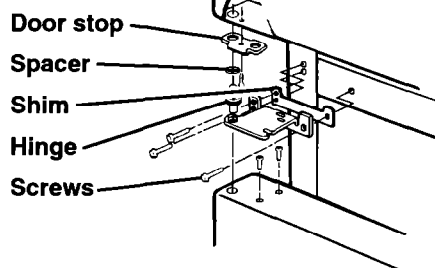

BOTTOM HINGE

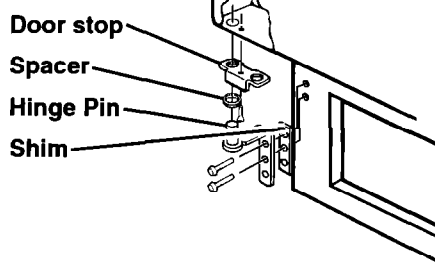

NOTE:

When replacing the doors, set the door gap at 11/16-inch (17 mm).

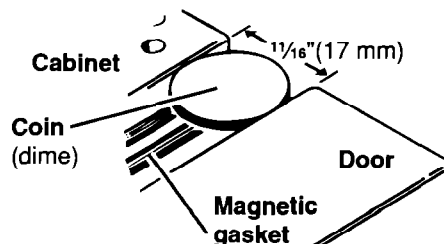

USING YOUR REFRIGERATOR

Reversing the handles

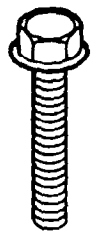
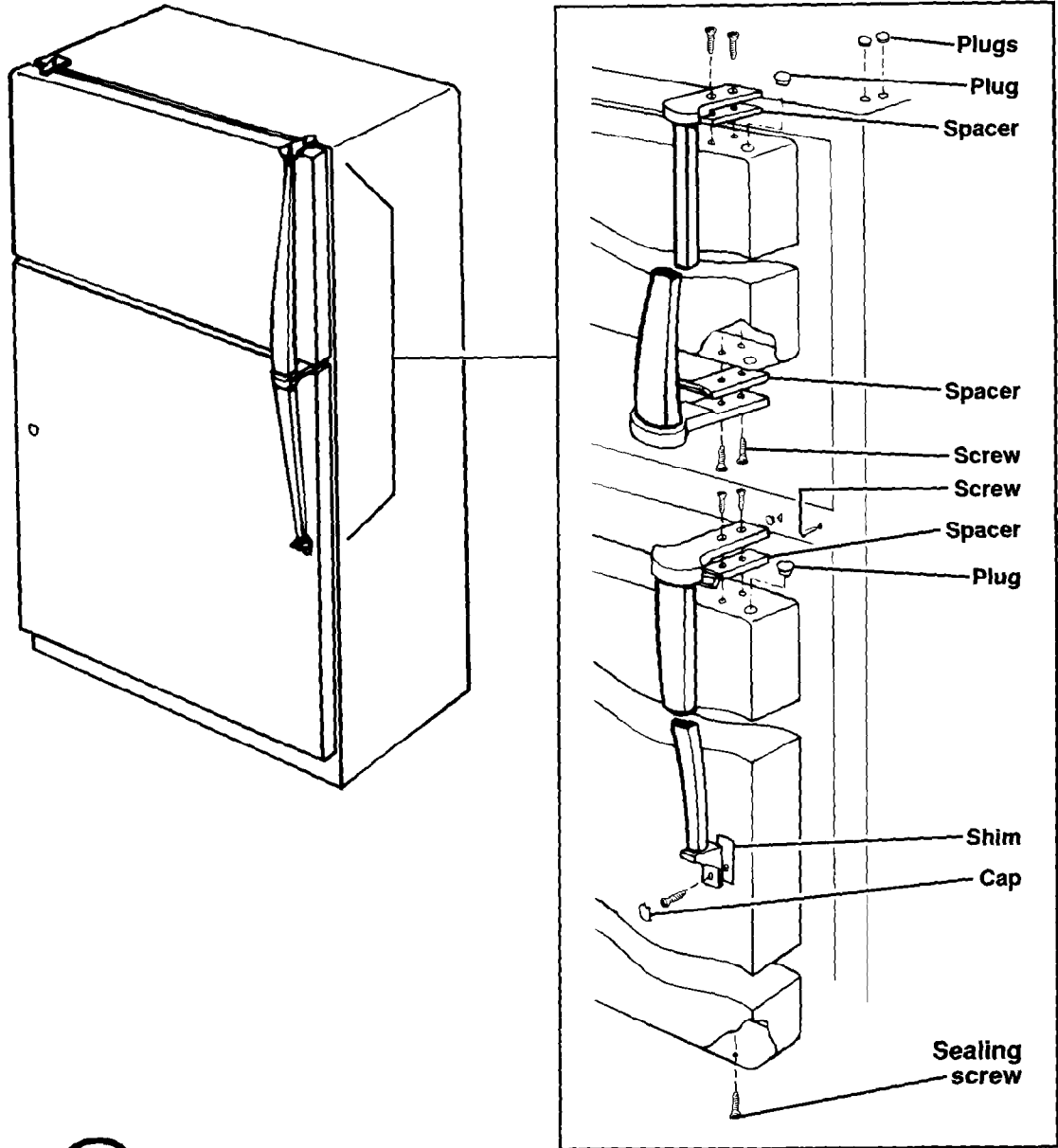

**5/16-inch HEX
HEAD HINGE
SCREW**



**COUNTERSINK
SCREW**



**OVAL SEALING
SCREW (USE ON
BOTTOM OF DOORS)**



**HANDLE
SCREW**



**OVAL SEALING
SCREW (USE ON
TOP OF DOORS)**

Caring For Your Refrigerator

Your refrigerator is built to give you many years of dependable service. However, there are a few things you can do to help extend its product life. This section tells you how to clean your refrigerator and what to do when going on vacation, moving, or during a power outage.

Cleaning your refrigerator



Both the refrigerator and freezer sections defrost automatically. However, clean both about once a month to help prevent odors from building up. Wipe up spills right away.

To clean your refrigerator, unplug it, take out all removable parts and clean the refrigerator according to the following directions.

⚠ WARNING



Burn Hazard

Do not touch refrigeration tubes near defrost pan.

Doing so can result in burns.

PART	WHAT TO USE	HOW TO CLEAN
Removable parts (shelves, crisper, etc.)	Sponge or cloth with mild detergent and warm water	<ul style="list-style-type: none"> • Hand wash and dry thoroughly.
Outside	Sponge, cloth, or paper towel with mild detergent, warm water, and a good appliance wax (or good auto paste wax)	<ul style="list-style-type: none"> • Wash outside of cabinet. Do not use abrasive or harsh cleaners. • Rinse and dry thoroughly. • Wax painted metal surfaces at least twice a year. Apply wax with a clean, soft cloth. Waxing painted metal surfaces provides rust protection. Do not wax plastic parts.
Inside walls (allow freezer to warm up so cloth won't stick)	Sponge, soft cloth, or paper towel with baking soda or mild detergent and warm water	<ul style="list-style-type: none"> • Wash with mixture of warm water and: <ul style="list-style-type: none"> – mild detergent, or – baking soda (2 tbs to 1 qt [26 g to .95 L] of water). • Wipe and dry thoroughly.
Door liners and gaskets	Sponge, soft cloth, or paper towel with mild detergent and warm water	<ul style="list-style-type: none"> • Wipe and dry thoroughly. <p>DO NOT USE cleaning waxes, concentrated detergents, bleaches, or cleaners containing petroleum on plastic parts.</p>

CARING FOR YOUR REFRIGERATOR

PART	WHAT TO USE	HOW TO CLEAN
Plastic parts (covers and panels)	Soft, clean sponge or soft, clean cloth with mild detergent and warm water	<ul style="list-style-type: none"> • Wipe and dry thoroughly. <p>DO NOT USE paper towels, window sprays, scouring cleansers, or flammable fluids. These can scratch or damage material. See “Important Safety Instructions” on page 3.</p>
Defrost pan	Sponge or cloth with mild detergent and warm water	<ul style="list-style-type: none"> • Remove base grille. (See page 19.) • Reach into small opening at right edge and remove the defrost pan. • Wash, rinse, and dry thoroughly. • Replace defrost pan. Make sure to push it completely into the opening. • Replace base grille. (See page 20.)
Condenser coils	Vacuum cleaner with extended narrow attachment	<ul style="list-style-type: none"> • Remove base grille. (See page 19.) • Vacuum coils when dusty or dirty. Coils may need to be cleaned as often as every other month. • Replace base grille. (See page 20.)

Vacation and moving care

Short vacations

No need to shut off the refrigerator if you will be away for less than four weeks.

1. Use up any perishables.
2. Freeze other items.
3. If your refrigerator has an automatic ice maker:
 - Raise signal arm to OFF (up) position.
 - Shut off water supply to the ice maker.
 - Empty the ice bin.

Long vacations

If you will be gone a month or more:

1. Remove all food from the refrigerator.
2. If your refrigerator has an automatic ice maker:
 - Turn off the water supply to the ice maker at least one day ahead of time.
 - When the last load of ice drops, turn off the ice maker. Make sure all ice is dispensed out of the ice maker mechanism.
3. Unplug the refrigerator.
4. Clean it, rinse well, and dry.
5. Tape rubber or wood blocks to the tops of both doors to prop them open far enough for air to get in. This stops odor and mold from building up.

To restart refrigerator, see "Using Your Refrigerator" on page 9.

Moving

When you are moving the refrigerator to a new home:

1. If your refrigerator has an automatic ice maker:
 - Turn off the water supply to the ice maker at least one day ahead of time.
 - Disconnect the water line.
 - After the last load of ice drops, lift the signal arm to the OFF (up) position.
2. Remove all food from the refrigerator.
3. Pack all frozen food in dry ice.
4. Unplug the refrigerator.
5. Clean it thoroughly. Rinse well and dry.
6. Take out all removable parts, wrap them well, and tape them together so they don't shift and rattle.
7. Screw in the leveling rollers.
8. Tape the doors shut and tape the power supply cord to the cabinet.

When you get to your new home, put everything back and refer to page 6. Also, if your refrigerator has an automatic ice maker, remember to reconnect the water supply line.

Power interruptions

If electricity goes off, call the power company. Ask how long power will be off.

1. If service will be interrupted 24 hours or less, **keep both doors closed**. This helps foods stay frozen.

2. If service will be interrupted longer than 24 hours:

(a) Remove all frozen food and store in a frozen food locker.

OR

(b) Place 2 lbs. (0.9 kg) of dry ice in freezer for every cubic foot of freezer space. This will keep food frozen for 2 to 4 days. Wear gloves to protect your hands from dry ice burns.

OR

(c) If neither a food locker or dry ice is available, use or can perishable food at once.

3. A full freezer stays cold longer than a partly filled one. A freezer full of meat stays cold longer than a freezer full of baked goods. If food contains ice crystals, it may be safely refrozen, although the quality and flavor may be affected. If the condition of the food is poor, or if you feel it is unsafe, dispose of it.

Questions?

Call us at **1-800-447-6737**.

Food Storage Guide

There is a correct way to package and store refrigerated or frozen food. To keep food fresher, longer, take the time to study these recommended steps.

Storing fresh food

Wrap or store food in the refrigerator in airtight and moisture-proof material. This prevents food odor and taste transfer throughout the refrigerator. For dated products, check code date to ensure freshness.

Leafy vegetables

Remove store wrapping and trim or tear off bruised and discolored areas. Wash in cold water and drain. Place in plastic bag or plastic container and store in crisper.

Vegetables with skins

(carrots, peppers)

Store in crisper, plastic bags, or plastic container.

Fruit

Wash, let dry and store in refrigerator in plastic bags or crisper. Do not wash or hull berries until they are ready to use. Sort and keep berries in their original container in a crisper, or store in a loosely closed paper bag on a refrigerator shelf.

Eggs

Store without washing in the original carton on interior shelf.

Milk

Wipe milk cartons. For best storage, place milk on interior shelf.

Butter or margarine

Keep opened butter in covered dish or closed compartment. When storing an extra supply, wrap in freezer packaging and freeze.

Cheese

Store in the original wrapping until you are ready to use it. Once opened, rewrap tightly in plastic wrap or aluminum foil.

Leftovers

Cover leftovers with plastic wrap or aluminum foil. Plastic containers with tight lids can also be used.

Meat

Store most meat in original wrapping as long as it is airtight and moisture-proof. Rewrap if necessary. See the following chart for storage times.

TYPE	APPROXIMATE TIME (DAYS)*
Chicken	1 to 2
Ground beef	1 to 2
Steaks and roasts	3 to 5
Cured meats	7 to 10
Bacon	5 to 7
Cold cuts	3 to 5
Variety meats	1 to 2

* When storing meat longer than the times given, follow the directions for freezing.

NOTE: Use fresh fish and shellfish the same day as purchased.

Storing frozen food

The freezer section is designed for storage of commercially frozen food and for freezing food at home.

NOTE: For further information about preparing food for freezing or food storage times, contact your local Cooperative Extension Service or check a freezer guide or reliable cookbook.

Packaging

The secret of successful freezing is in the packaging. The way you close and seal the package must not allow air or moisture in or out. Packaging done in any other way could cause food odor and taste transfer throughout the refrigerator and drying of frozen food.

Packaging recommended for use:

- Rigid plastic containers with tight-fitting lids
- Straight-sided canning/freezing jars
- Heavy-duty aluminum foil
- Plastic-coated paper
- Non-permeable plastic wraps (made from a saran film)

Follow package or container instructions for proper freezing methods.

Do not use:

- Bread wrappers
- Non-polyethylene plastic containers
- Containers without tight lids
- Waxed paper
- Wax-coated freezer wrap
- Thin, semi-permeable wrap

The use of these wrappings could cause food odor, taste transfer, and drying of frozen food.

Freezing

Do not expect your freezer to quick-freeze any large quantity of food. Put no more unfrozen food into the freezer than will freeze within 24 hours (no more than 2 to 3 pounds of food per cubic foot of freezer space). Leave enough space for air to circulate around packages. Be careful to leave enough room at the front so the door can close tightly.

Storage times will vary according to the quality of the food, the type of packaging or wrap used (airtight and moisture-proof) and the storage temperature, which should be 0°F (-17.8°C).

Troubleshooting

Listed in the chart below are the most common problems consumers run into with their refrigerator. Please read through this chart before calling for service. It could save you the cost of a service call.

PROBLEM	CHECK THE FOLLOWING
Your refrigerator will not operate	Is the power supply cord firmly plugged into a live circuit with proper voltage? Has a household fuse or circuit breaker blown/tripped? Is the Refrigerator Control set to the OFF position?
The lights do not work	Is the power supply cord firmly plugged into a live circuit with proper voltage? Has a household fuse or circuit breaker blown/tripped? Is a bulb burned out?
The ice maker does not work	Is the freezer cold enough to make ice? It could take overnight for the freezer to reach the proper temperature. Is the ON/OFF lever in the ON (down) position? (See page 16.) Is the water valve turned on? Does the water line have a clog or leak?
You hear unfamiliar sounds or a rattling/jingling noise	Is something on top of or behind the refrigerator? Some new sounds are normal. See "Understanding the sounds you may hear" on page 21.
There is water in the defrost pan	This is normal on hot, muggy days. Make sure the refrigerator is level so the pan does not overflow.
The motor seems to run too much	Are the condenser coils dirty? Has the door been opened often? Has a large amount of food been added at one time? The motor naturally runs longer if these things happen. Is the room hot? If the room is too warm, the motor runs longer to keep the unit cool.

Requesting Assistance Or Service

Before calling for assistance or service, please check "Troubleshooting" on page 30. It may save you the cost of a service call. If you still need help, follow the instructions below.

1. If you need assistance* ...

Call our toll-free telephone number.



Dial free from anywhere in the U.S.A.:

**1-800-44-ROPER
(1-800-447-6737)**

and talk with one of our trained consultants. The consultant can instruct you in how to obtain satisfactory operation from your appliance or, if service is necessary, recommend a qualified service company in your area.

If you prefer, write to:

Roper Brand Home Appliances
Consumer Assistance Center
c/o Correspondence Dept.
2000 North M-63
Benton Harbor, MI 49022-2692

Please include a daytime phone number in your correspondence.

2. If you need service* ...

Contact the dealer from whom you



purchased the appliance or the authorized servicer in your area. For help finding an authorized servicer in your area, call our toll-free

number in Step 1.

3. If you need FSP® replacement parts ...

FSP is a registered trademark of Whirlpool Corporation for quality parts. Look for this symbol of quality whenever you need a replacement part for your ROPER® appliance. FSP replacement parts will fit right and work right, because they are made to the same exacting specifications used to build every new ROPER appliance.

To locate FSP replacement parts in your area, refer to Step 2 or call our toll-free telephone number in Step 1.

4. If you are not satisfied with how the problem was solved ...

- Contact the Major Appliance Consumer Action Program (MACAP). MACAP is a group of independent consumer experts that voices consumer views at the highest levels of the major appliance industry.
- Contact MACAP only when the dealer, authorized servicer and Whirlpool have failed to resolve your problem.

Major Appliance Consumer Action Program
20 North Wacker Drive
Chicago, IL 60606

- MACAP will in turn inform us of your action.

* When asking for help or service:

Please provide a detailed description of the problem, your appliance's complete model and serial numbers, and the purchase date. (See page 2.) This information will help us respond properly to your request.

ROPER®

Refrigerator Warranty

LENGTH OF WARRANTY	WE WILL PAY FOR
FULL ONE-YEAR WARRANTY (from date of purchase)	FSP® replacement parts and repair labor to correct defects in materials or workmanship. Service must be provided by an authorized Roper service company.
FULL FIVE-YEAR WARRANTY (from date of purchase)	FSP replacement parts and repair labor for the sealed refrigeration system (compressor, evaporator, condenser, drier or connecting tubing) which we find to be defective in materials or workmanship. Service must be provided by an authorized Roper service company.
WE WILL NOT PAY FOR	
<p>A. Service calls to:</p> <ol style="list-style-type: none"> 1. Correct the installation of your refrigerator. 2. Instruct you how to use your refrigerator. 3. Replace house fuses or correct house wiring or plumbing. 4. Replace light bulbs. <p>B. Repairs when your refrigerator is used in other than normal, single-family household use.</p> <p>C. Pickup and delivery. Your refrigerator is designed to be repaired in the home.</p> <p>D. Damage to your refrigerator caused by accident, misuse, fire, flood, acts of God or use of products not approved by Whirlpool.</p> <p>E. Any food loss due to product failure.</p> <p>F. Repairs to parts or systems caused by unauthorized modifications made to the appliance.</p>	

3/96

THIS ROPER APPLIANCE IS WARRANTED BY WHIRLPOOL CORPORATION. UNDER NO CIRCUMSTANCES SHALL IT BE LIABLE UNDER THIS WARRANTY FOR INCIDENTAL OR CONSEQUENTIAL DAMAGES. Some states do not allow the exclusion or limitation of incidental or consequential damages, so this exclusion or limitation may not apply to you. This warranty gives you specific legal rights, and you may also have other rights which vary from state to state.

Outside the United States, a different warranty may apply. For details, please contact your authorized Roper dealer.

If you need service, first see the "Troubleshooting" section of this book. After checking "Troubleshooting," additional help can be found by checking the "Requesting Assistance or Service" section, or by calling our toll-free telephone number, **1-800-44-ROPER (1-800-447-6737)**, from anywhere in the U.S.A.

PART NO. 2193498
CARD NO. 2195265

© 1996 Whirlpool Corporation

© Registered Trademark of Whirlpool, U.S.A.

6/96
Printed in U.S.A.