

Register your product and get support at

[www.philips.com/welcome](http://www.philips.com/welcome)

AS851



Thank you for choosing Philips.

### Need help fast?

Read your Quick Start Guide and/or User Manual first for quick tips that make using your Philips product more enjoyable.

If you have read your instructions and still need assistance, you may access our online help at

[www.philips.com/welcome](http://www.philips.com/welcome)  
or call

**1-888-PHILIPS (744-5477)**

while with your product.

(and Model / Serial number)



Philips vous remercie de votre confiance.

### Besoin d'une aide rapide?

Le Guide rapide de début et Manuel de l'utilisateur regorgent d'astuces destinées à simplifier l'utilisation de votre produit Philips. Toutefois, si vous ne parvenez pas à résoudre votre problème, vous pouvez accéder à notre aide en ligne à l'adresse

[www.philips.com/welcome](http://www.philips.com/welcome)  
ou formez le

**1-800-661-6162 (Francophone)**

**1-888-PHILIPS (744-5477) (English speaking)**

Veillez à avoir votre produit à portée de main.

(et model / serial nombre)



Gracias por escoger Philips

### Necesita ayuda inmediata?

Lea primero la Guía rápida del comienzo o el Manual del usuario, en donde encontrará consejos que le ayudarán a disfrutar plenamente de su producto Philips.

Si después de leerlo aún necesita ayuda, consulte nuestro servicio de asistencia en línea en

[www.philips.com/welcome](http://www.philips.com/welcome)  
o llame al teléfono

**1-888-PHILIPS (744-5477)**

y tenga a mano el producto.

(y número de model / serial)



# User manual

# PHILIPS

# Canada

## English:

This digital apparatus does not exceed the Class B limits for radio noise emissions from digital apparatus as set out in the Radio Interference Regulations of the Canadian Department of Communications. This Class B digital apparatus complies with Canadian ICES-003.

## Français:

Cet appareil numérique n'émet pas de bruits radioélectriques dépassant les limites applicables aux appareils numériques de Classe B prescrites dans le Règlement sur le Brouillage Radioélectrique édicté par le Ministère des Communications du Canada. Cet appareil numérique de la classe B est conforme à la norme NMB-003 du Canada.

**The set complies with the FCC-Rules, Part 15 and with 21 CFR 1040.10.**

**Operation is subject to the following two conditions:**

1. This device may not cause harmful interference, and
2. This device must accept any interference received, including interference that may cause undesired operation.

**L'appareil est conforme à la réglementation FCC, section 15, et à la norme 21 CFR 1040.10. Son utilisation est soumise à deux conditions :**

1. L'appareil ne doit pas provoquer d'interférences nuisibles, et
2. L'appareil doit supporter les interférences reçues, y compris les interférences empêchant son fonctionnement correct.

# Contents

---

<b>1</b>	<b>Important</b>	<b>4</b>
	Safety	4
	Notice	5

---

<b>2</b>	<b>Your docking speaker for Android™</b>	<b>6</b>
	Introduction	6
	What's in the box	6
	Overview of the main unit	7
	Overview of remote control	8

---

<b>3</b>	<b>Get started</b>	<b>9</b>
	Connect power	9
	Prepare the remote control	9
	Turn on	9

---

<b>4</b>	<b>Play and charge</b>	<b>10</b>
	Compatible with Android™	10
	Play music through Bluetooth	10
	Play music with Fidelio app	12
	Install "Songbird app" to enjoy music	18
	Use your remote control	20
	Dock and charge Android-powered device	21

---

<b>5</b>	<b>Other features</b>	<b>23</b>
	Listen to internet radio	23
	Set sleep timer	24
	Set alarm timer	25

---

<b>6</b>	<b>Product information</b>	<b>27</b>
	Specifications	27

---

<b>7</b>	<b>Troubleshooting</b>	<b>28</b>
----------	------------------------	-----------

# 1 Important

## Safety

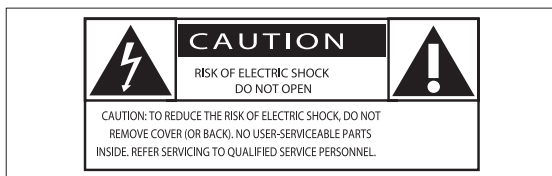

This 'bolt of lightning' indicates uninsulated material within your unit may cause an electrical shock. For the safety of everyone in your household, please do not remove product covering.

The 'exclamation point' calls attention to features for which you should read the enclosed literature closely to prevent operating and maintenance problems.

**WARNING:** To reduce the risk of fire or electric shock, this apparatus should not be exposed to rain or moisture and objects filled with liquids, such as vases, should not be placed on this apparatus.

**CAUTION:** To prevent electric shock, match wide blade of plug to wide slot, fully insert.

## Important Safety Instructions

- ① Read these instructions.
  - ② Keep these instructions.
  - ③ Heed all warnings.
  - ④ Follow all instructions.
  - ⑤ Do not use this apparatus near water.
  - ⑥ Clean only with dry cloth.
  - ⑦ Do not block any ventilation openings. Install in accordance with the manufacturer's instructions.
  - ⑧ Do not install near any heat sources such as radiators, heat registers, stoves, or other apparatus (including amplifiers) that produce heat.
  - ⑨ Protect the power cord from being walked on or pinched, particularly at plugs, convenience receptacles, and the point where they exit from the apparatus.
  - ⑩ Only use attachments/accessories specified by the manufacturer.
  - ⑪ Use only with the cart, stand, tripod, bracket, or table specified by the manufacturer or sold with the apparatus. When a cart is used, use caution when moving the cart/apparatus combination to avoid injury from tip-over.
- 
- ⑫ Unplug this apparatus during lightning storms or when unused for long periods of time.
  - ⑬ Refer all servicing to qualified service personnel. Servicing is required when the apparatus has been damaged in any way, such as power-supply cord or plug is damaged, liquid has been spilled or objects have fallen into the apparatus, the apparatus has been exposed to rain or moisture, does not operate normally, or has been dropped.
  - ⑭ Apparatus shall not be exposed to dripping or splashing.
  - ⑮ Do not place any sources of danger on the apparatus (e.g. liquid filled objects, lighted candles).
  - ⑯ This product may contain lead and mercury. Disposal of these materials may be regulated due to environmental considerations. For disposal or recycling

information, please contact your local authorities or the Electronic Industries Alliance: [www.eiae.org](http://www.eiae.org).

- ⑰ Where the plug of the Direct Plug-in Adapter is used as the disconnect device, the disconnect device shall remain readily operable.

### Warning

- Never remove the casing of this apparatus.
- Never lubricate any part of this apparatus.
- Never place this apparatus on other electrical equipment.
- Keep this apparatus away from direct sunlight, naked flames or heat.
- Ensure that you always have easy access to the power cord, plug or adaptor to disconnect the apparatus from the power.

### Caution

- Batteries (battery pack or batteries installed) shall not be exposed to excessive heat such as sunshine, fire, or the like.
- Danger of explosion. If battery is incorrectly replaced. Replace only with the same or equivalent type.

## Notice

Any changes or modifications made to this device that are not expressly approved by Philips Consumer Lifestyle may void the user's authority to operate the equipment.

The set complies with the FCC-Rules, Part 15. Operation is subject to the following two conditions:

1. This device may not cause harmful interference, and
2. This device must accept any interference received, including interference that may cause undesired operation.

## Disposal of your old product and batteries

Your product is designed and manufactured with high quality materials and components, which can be recycled and reused.

Never dispose of your product with other household waste. Please inform yourself about the local rules on the separate collection of electrical and electronic products and batteries. The correct disposal of these products helps prevent potentially negative consequences on the environment and human health.

Your product contains batteries, which cannot be disposed of with normal household waste. Please inform yourself about the local rules on separate collection of batteries. The correct disposal of batteries helps prevent potentially negative consequences on the environment and human health.

Please visit [www.recycle.philips.com](http://www.recycle.philips.com) for additional information on a recycling center in your area.

### Environmental information

All unnecessary packaging has been omitted. We have tried to make the packaging easy to separate into three materials: cardboard (box), polystyrene foam (buffer) and polyethylene (bags, protective foam sheet.)

Your system consists of materials which can be recycled and reused if disassembled by a specialized company. Please observe the local regulations regarding the disposal of packaging materials, exhausted batteries and old equipment.

### Note

- The type plate is located on the bottom of the apparatus.

## 2 Your docking speaker for Android™

Congratulations on your purchase, and welcome to Philips! To fully benefit from the support that Philips offers, register your product at [www.philips.com/welcome](http://www.philips.com/welcome).

---

### Introduction

With this docking speaker, you may enjoy following features:

- Enjoy audio from your Bluetooth-enabled portable device;
- Charge your device with micro USB connector;
- Experience various features brought by Philips Fidelio app and Songbird app.

---

### What's in the box

Check and identify the contents of your package:

- Main unit
- Power adapter
- Dock extension
- Quick start guide
- Safety sheet

## Overview of the main unit

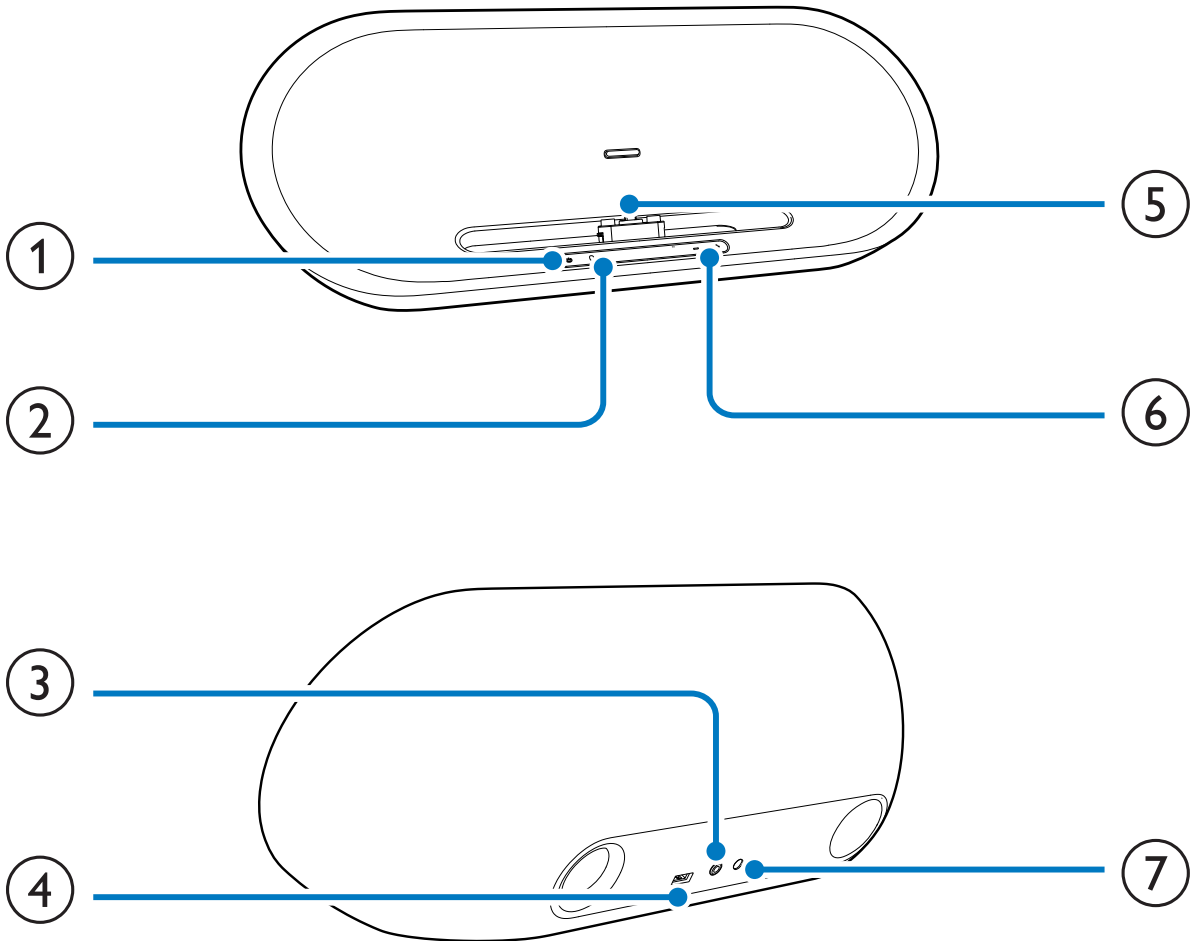



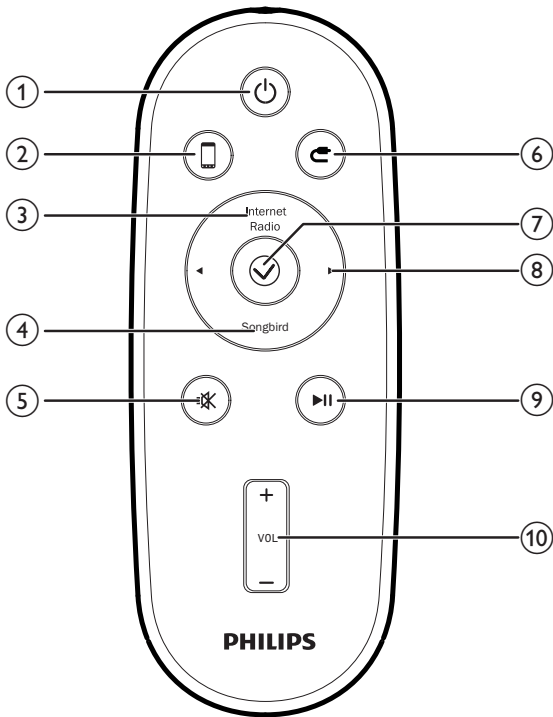

- ① **⏻**
- Turn the device on/off.
  - Switch the docking speaker to standby mode.
- ② **⌘**
- Bluetooth indicator.
- ③ **AUX IN**
- Connect an audio device.
- ④ **Power out**
- Charge your portable device through USB link cable.

- ⑤ **Dock base**
- ⑥ **+/-**
- Adjust sound volume.
- ⑦ **18V**
- Connect to power supply.

## Overview of remote control



- ⑨ ▶||
  - Start or pause play.
- ⑩ VOL +/-
  - Adjust volume.

- ① 
  - Turn Bluetooth on/off.
- ② 
  - Select dock source.
- ③ **Internet Radio**
  - Access internet radio in Fidelio app.
- ④ **Songbird**
  - Open Songbird player.
- ⑤ 
  - Mute or resume volume.
- ⑥ 
  - Select Mp3 link source.
- ⑦ 
  - Access the clock display page in Fidelio all.
- ⑧ ◀/▶
  - Go to previous/next track.



# 3 Get started

Always follow the instructions in this chapter in sequence.

## Connect power

### ! Caution

- Risk of product damage! Make sure that the power voltage corresponds to the voltage printed on the back or underside of the clock radio.
- Risk of electric shock! When you unplug the AC adaptor, always pull the plug from the socket. Never pull the cord.

### ! Warning

- To reduce the risk of fire or electric shock, do not expose this clock radio to rain or moisture.

Connect the power adapter to the wall socket.

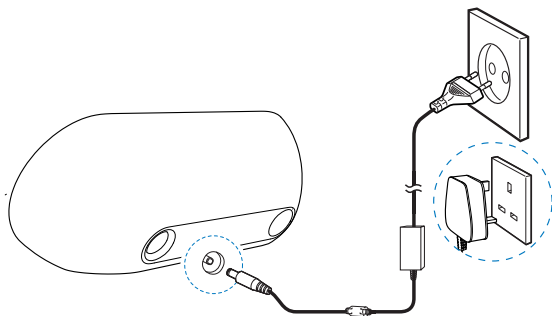

## Prepare the remote control

### ! Caution

- Risk of explosion! Keep batteries away from heat, sunshine, or fire. Never discard batteries in fire.

- 1 Open the battery compartment.
- 2 Insert one button battery with correct polarity (+/-) as indicated.

- 3 Close the battery compartment.

### ≡ Note

- If you are not going to use the remote control for a long time, remove the batteries.

## Turn on

Press  $\phi$ .

- ↳ The Bluetooth indicator  $\star$  on the display panel begins to blink.

## Switch to standby mode

Press  $\phi$  again to switch the docking speaker to standby mode.

- ↳ The Bluetooth indicator  $\star$  on the display panel goes off.

## 4 Play and charge

With this docking speaker, you can enjoy music in two ways:

- Through manual Bluetooth connection;
- Through automatic Bluetooth connection with Philips Fidelio app.

---

### Compatible with Android™

To make full use of your docking speaker, your phone should satisfy the following requirements:

- With Android operation system (Version 2.1 or above);
- With Bluetooth software (Version 2.1 or above); and
- With a micro USB connector.

For other non Android-powered smartphone with micro USB connector and Bluetooth, you can still use the docking speaker to do the following:

- Charge your phone through the connector;
- Enjoy audio through Bluetooth.



Tip

- For more details, visit [www.philips.com/flexidock](http://www.philips.com/flexidock).

---

### Play music through Bluetooth

- 1 Press  $\Phi$  to activate Bluetooth on the device.  
↳ The Bluetooth indicator  $\Phi$  begins to blink.
- 2 On your phone, go to **[Settings]** (Settings) > **[Wireless and networks]** (Wireless and networks) > **[Bluetooth settings]** (Bluetooth settings).

- 3 Tap **[Bluetooth]** (Bluetooth) to turn on Bluetooth on your phone.

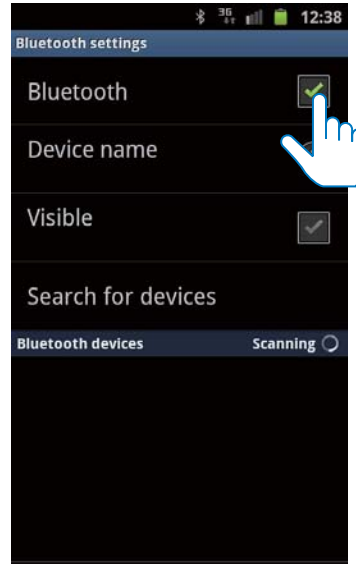

- 4 Tap **[Search for devices]** (Search for devices).

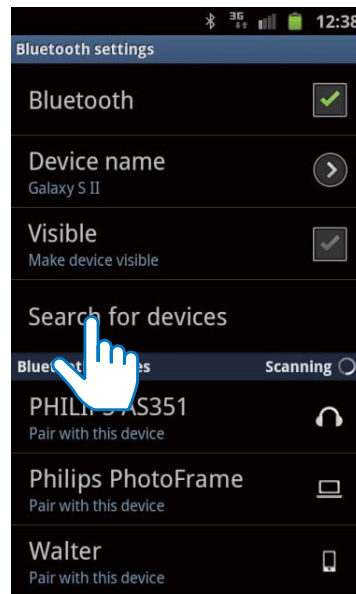

5 Tap [PHILIPS AS851].

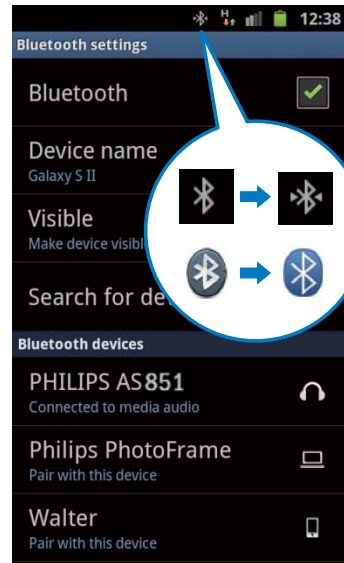
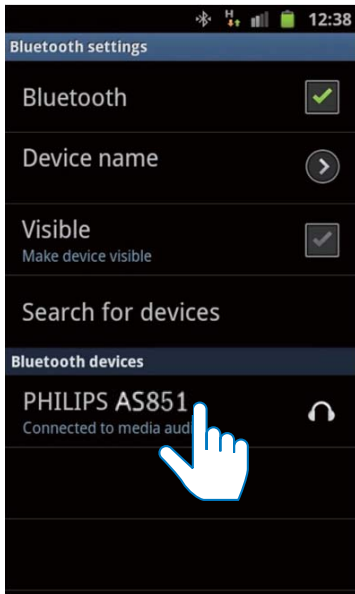

7 Play music through audio player on your portable device.

↳ A Bluetooth pairing request appears.

6 Tap [Accept] (Accept) to start pairing your portable device with the docking speaker.

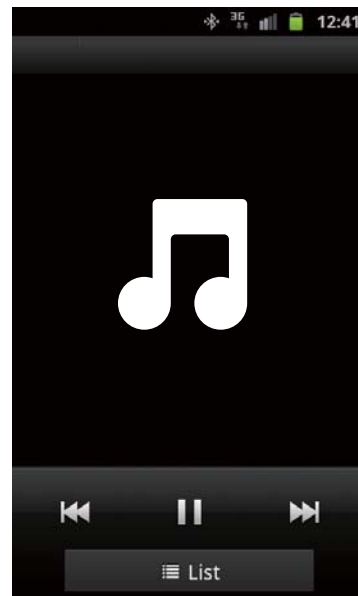
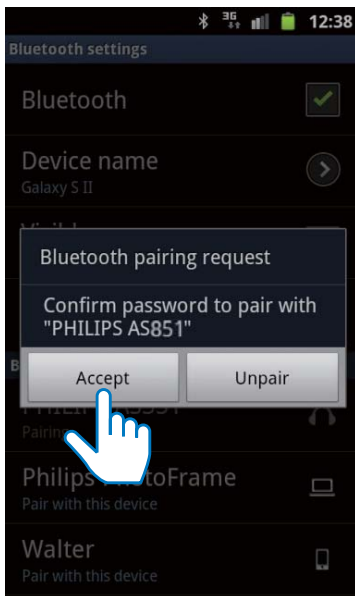

↳ The music comes out through the docking speaker.

↳ A different Bluetooth icon can be found on the top of the screen and the device are connected through Bluetooth.

**Note**

- The settings on the phone may vary from model to model.
- To keep constant Bluetooth connection, keep your portable device within 10 m to the docking speaker.

## Play music with Fidelio app

Philips Fidelio app brings a suite of new features to your docking speaker, including automatic Bluetooth connection, Songbird music player, Internet radio, and a multi-function alarm clock. To enjoy more features, you are recommended to download and install free "Fidelio app".

## Install "Fidelio app" onto Android powered device

You have two ways to install "Fidelio app" on your Android-powered device.

### Install "Fidelio" through QR code

#### Note

- Make sure that your Android powered device is connected to the Internet.
- Make sure that your Android powered device has a scanning software application. If you do not have one, download one from Android market.

- 1 Use the scanning software to scan the QR code.

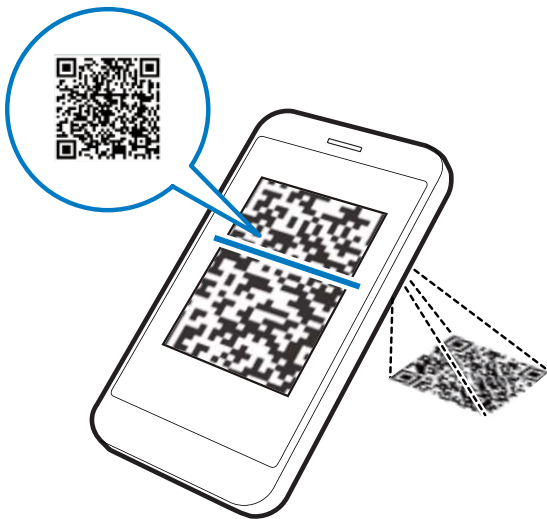

- 2 Tap [Install] (Install).



- 3 Tap [Accept & download] (Accept & download).

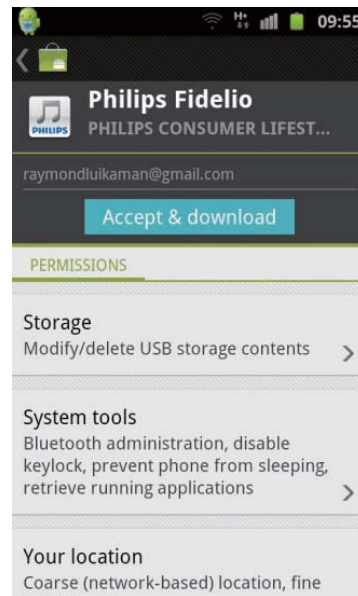

- ↳ Fidelio app downloading and installation starts.

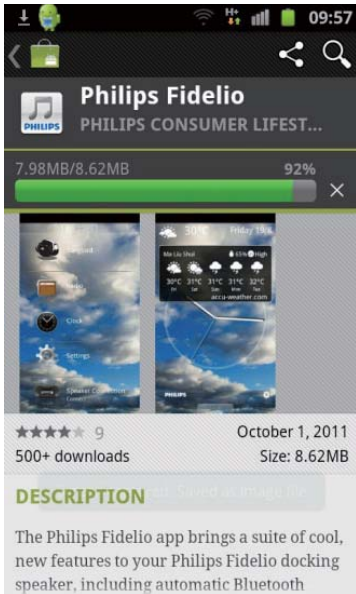

↳ Fidelio app is installed.

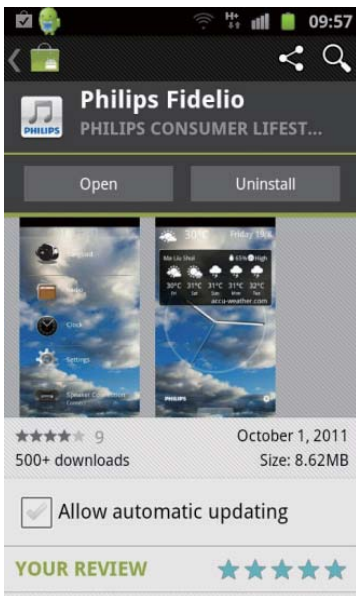

↳ Fidelio app's icon is displayed on the home page.

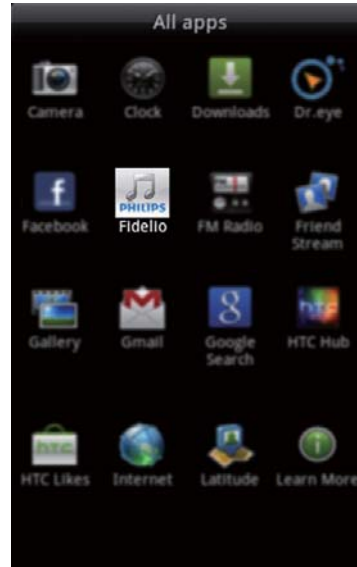

### Install "Fidelio" through Anroid Market

Note

- Make sure that your Android powered device is connected to the Internet.
- Make sure that you Android powered device is equipped with Android Market.

1 Tap the Android Market icon on the main screen.



- 2 Tap the search icon on the screen to access search bar:

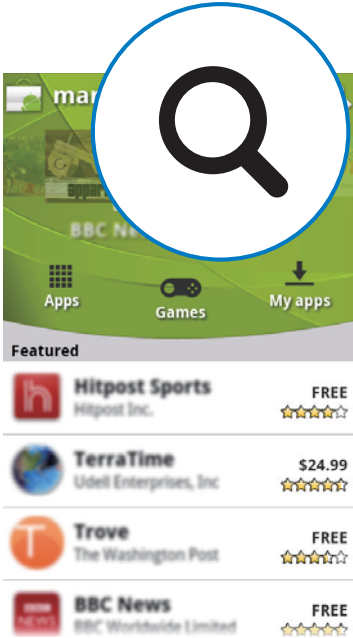

- 3 In the search bar, type in the "Fidelio" and search for "Fidelio app".



- 4 In the search result list, find and tap "Fidelio app" to start Fidelio app download.

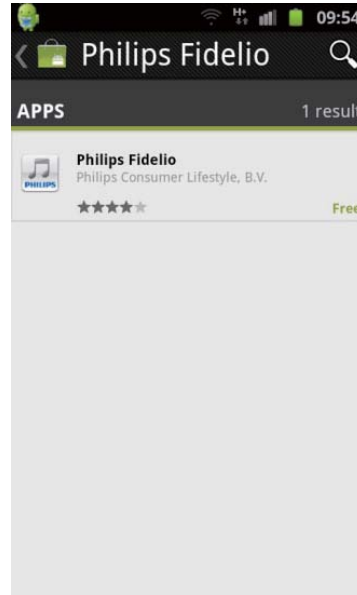

- 5 Tap [Install] (Install).

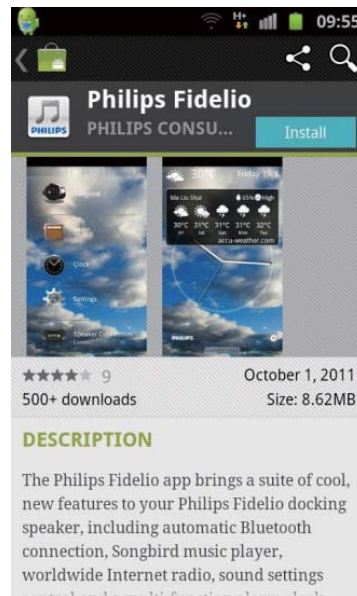



6 Tap [Accept & download] (Accept & download).

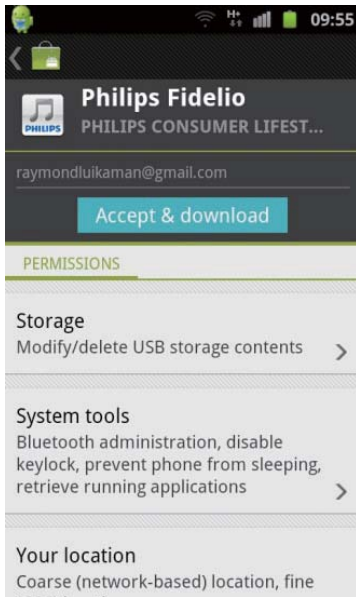

↳ Fidelio app downloading and installation starts.

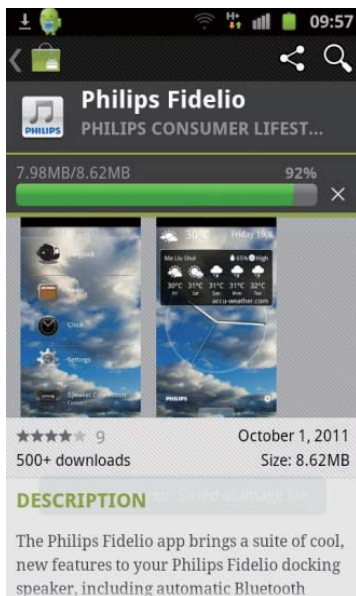

↳ Fidelio app is installed.

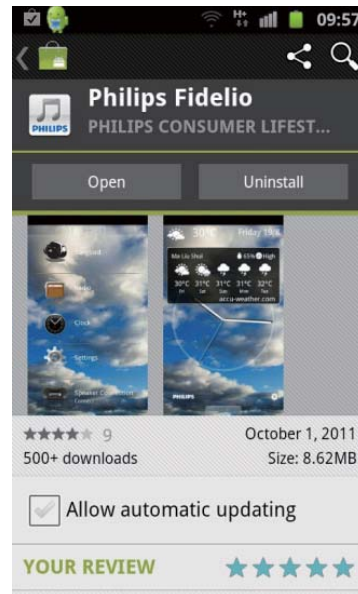

↳ Fidelio app's icon is displayed on the home page.

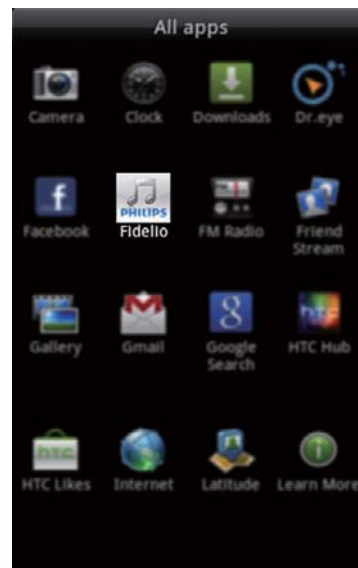

## Activate Bluetooth with Fidelio app

Philips Fidelio app helps to connect your Android-powered device and docking speaker through Bluetooth automatically.

- 1 Press  $\Phi$  to activate Bluetooth on the device.  
↳ The Bluetooth indicator  $\mathfrak{B}$  begins to blink.
- 2 Tap the Fidelio app icon on the home page to open Fidelio application, and go to the main menu.



- 3 Tap [Speaker Connection] (Speaker Connection).

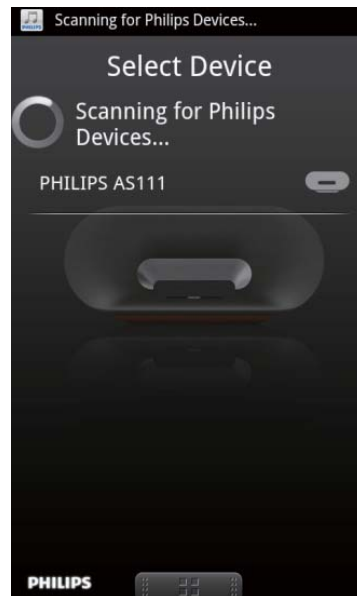
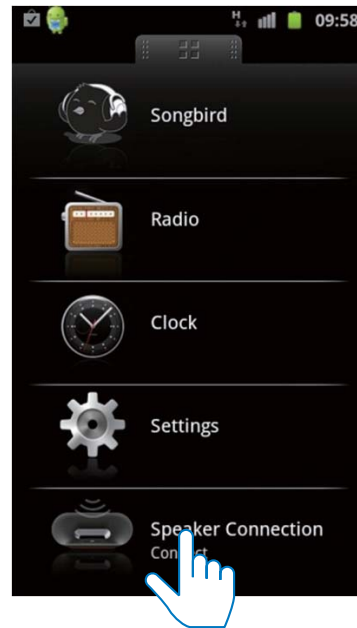



4 Tap [PHILIPS AS851].



↳ AS851 is connected to the device through Bluetooth.



5 Select your desired song, and tap ▶.

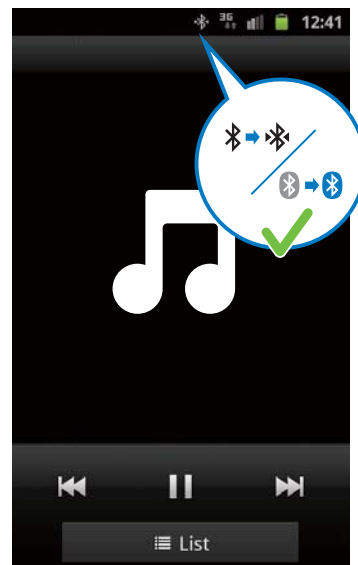

↳ You now may enjoy your music through the device.

## Install "Songbird app" to enjoy music

Philips Songbird is a simple, easy-to-use PC program and Android app. It lets you discover, play, and sync your media from PC to your Android-powered devices seamlessly.

### Install songbird app on portable device

- 1 Tap the Fidelio app icon on the main screen to open Fidelio app.

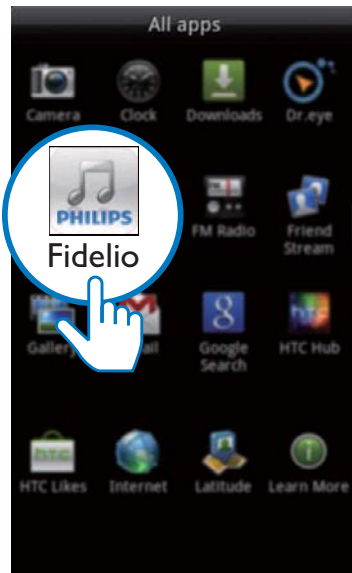

- 2 Tap the [songbird] on the main menu of Fidelio app.

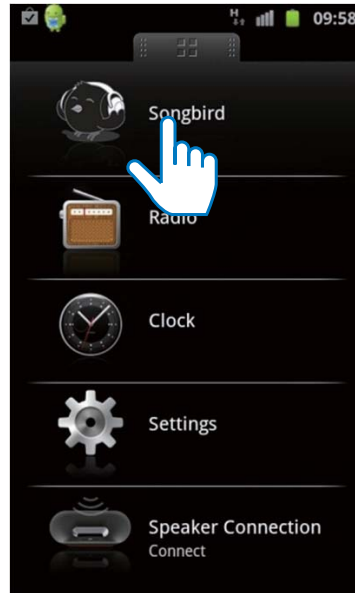

↳ You are requested to download Songbird.

- 3 Tap [download] (download).

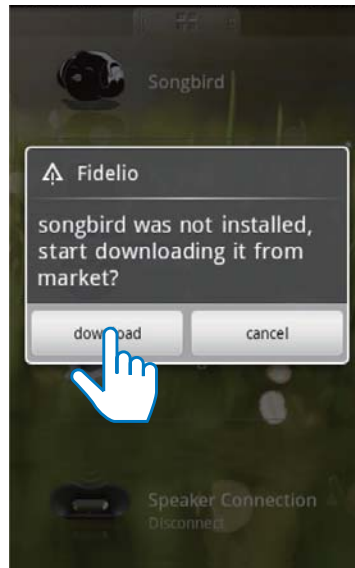

↳ Songbird is downloaded.

4 Tap the downloaded Songbird app.

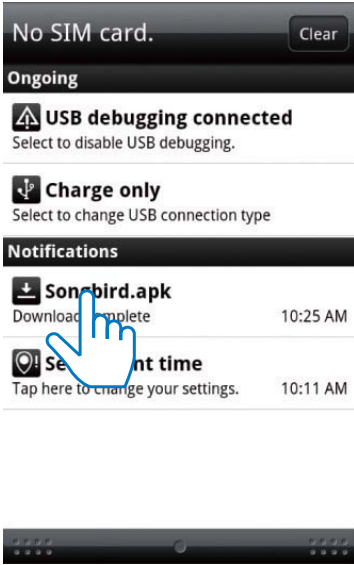

↳ The system asks whether you want to install Songbird.

5 Tap [Install] (Install).



↳ Songbird is installed.

6 Tap [Open] (Open) to access Songbird menu.



7 Select your desired song through Songbird app from your portable device, and tap ▶.

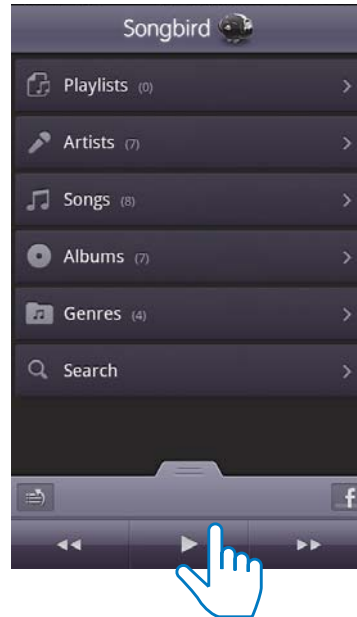



↳ You now can enjoy your music through the device.

## Install Songbird on your computer

- 1 Go to [www.philips.com/songbird](http://www.philips.com/songbird).
- 2 Download the latest Songbird application.
- 3 Follow on-screen instructions to install Songbird on your computer.

## Sync music from PC to Android powered device

### Note

- Make sure that both your computer and Android powered device are installed with Songbird app.

- 1 Connect your Android powered device to the computer with a USB cable.  
↳ A prompt window appears.

- 2 Select **[Managing device using Philips Songbird]** (Managing device using Philips Songbird).



↳ The Songbird user interface is displayed.

- 3 Select **[Auto Sync Music]** (Auto Sync Music) and **[Sync all music and playlists]** (Sync all music and playlists).
- 4 Click **[Sync]** (Sync) on the top right of the interface.  
↳ The music on your computer is synchronized into Android powered device.

### Tip

- Next time when Android powered device is connected to this computer, music is synchronized from PC to the device automatically.

## Use your remote control





### Note

- When there are inputs from dock source and Mp3-Link at the same time, audio from dock source is played.



## Play audio from dock

### Note

- Make sure that the docking speaker is successfully connected to the Android- powered device through Bluetooth.

- 1 Press  to select dock source.
- 2 To access Internet radio, press **Internet Radio**.
- 3 To open songbird app and play audio, press **Songbird**.
  - To pause/resume the play, press .
  - Go to previous/next track, press .
  - To adjust volume, press **VOL +/-** and .

## Play audio from MP3-Link

- 1 Connect **AUX IN** to outer audio device.
- 2 Press  to select MP3-Link source.
- 3 Play audio on your audio device.
  - To adjust volume, press **VOL +/-** and .

## Dock and charge Android-powered device

You can charge your Android-powered device by docking the device onto the docking speaker.

### Dock your portable device

- 1 Check the orientation of the micro USB connector on the portable device, and rotate the micro USB connector on the docking speaker if necessary. Then dock your portable device onto the device.

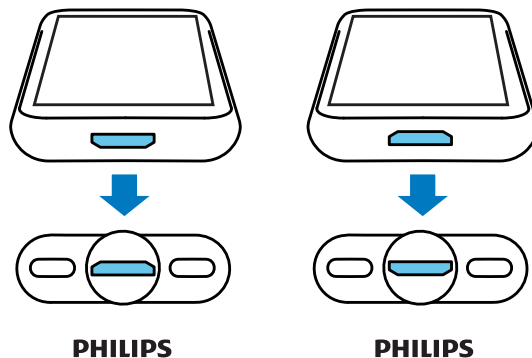
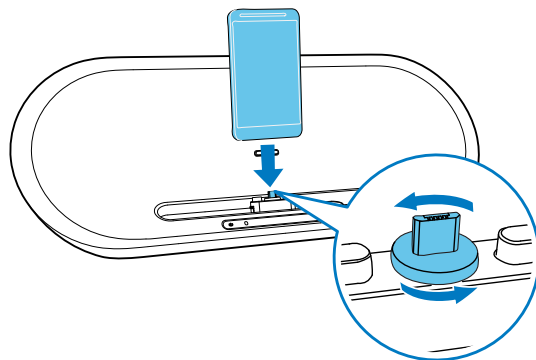

- 2 Slide the connector to the center of the device.

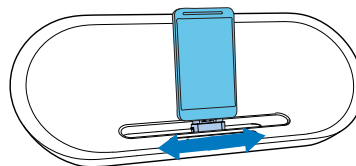

- 3 Adjust the bumpers on both sides to stabilize the portable device.

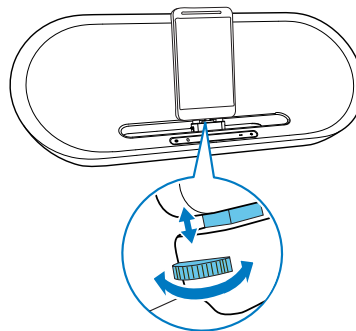



### Tip

- If the micro USB connector is located at the top, and you are using Android system of version 2.3 or above, screen auto-rotation is available.

---

## Use dock extension

If the USB connector on your portable device is close to the edge, use the supplied dock extension to balance the device, as illustrated.

- 1 Adjust the bumpers on both sides to the lowest position.
- 2 Put on the dock extension.
- 3 Dock your portable device.

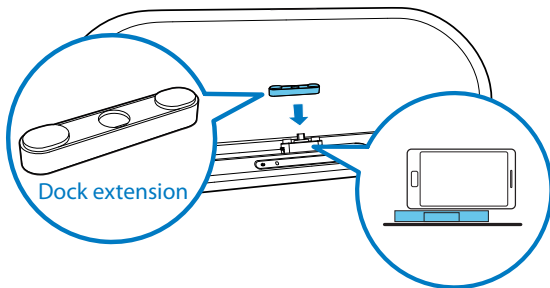

---

## Charge your portable device

When the docking speaker is connected to power, the portable device starts charging automatically.



### Tip

- This function is also available for non Android-powered device that has a micro-USB connector.

# 5 Other features

If you installed Fidelio app (see Chapter 4) onto your Android-powered device, you can use it to listen to Internet radio and to set timer:

## Listen to internet radio

- 1 Connect your portable device and the docking speaker through Bluetooth.
- 2 Open Fidelio app and go to the main menu.



- 3 Tap [Radio] (Radio) on the main menu.

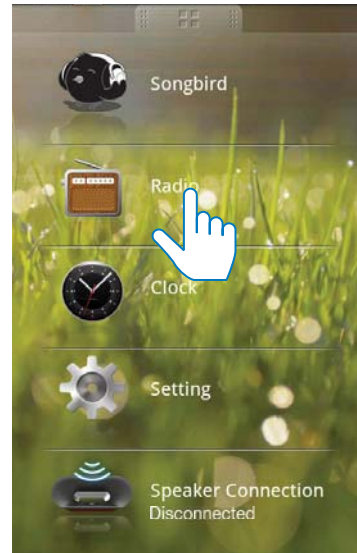

- 4 Type in the radio station you desired in the search bar:



- 5 Tap the desired radio station.  
↳ Your desired radio station begins to broadcast.

## Set sleep timer

- 1 Open Fidelio app.

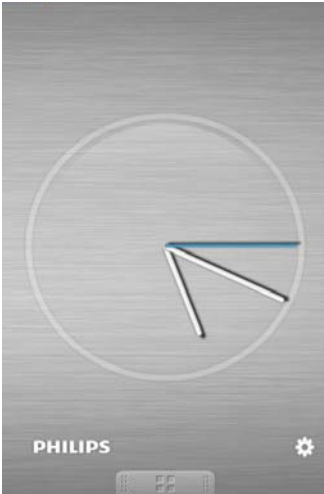

- 2 Tap the icon  to access clock setting Menu.

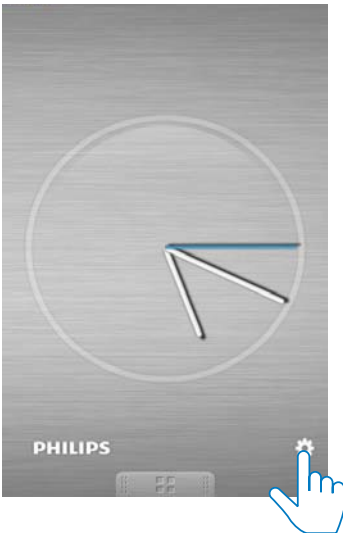

- 3 Tap **[Sleep Timer]** (Sleep timer).

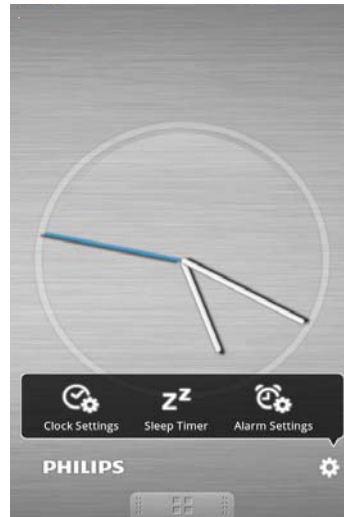

- 4 Select 10/15/20/30/45/60/90 min, then tap **[Start]** (Start).

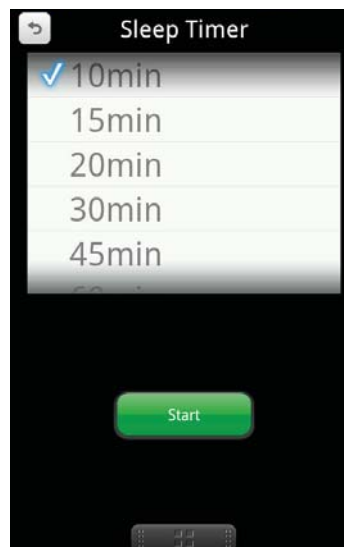

### Note

- Sleep timer only works with Songbird app.



## Set alarm timer

- 1 Open Fidelio app.

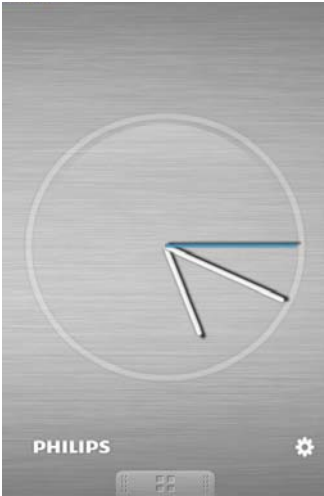

- 2 Tap the icon  to access clock setting Menu.

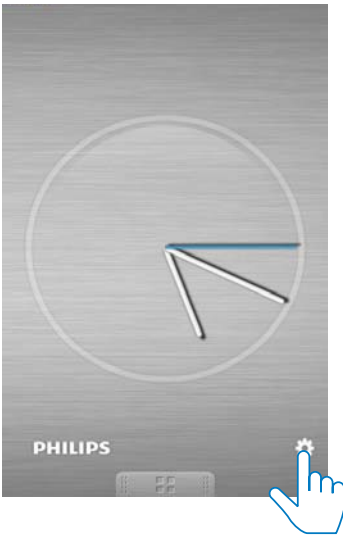

- 3 Tap [Alarm settings](Alarm settings).



- 4 Tap  to access alarm configuration page.

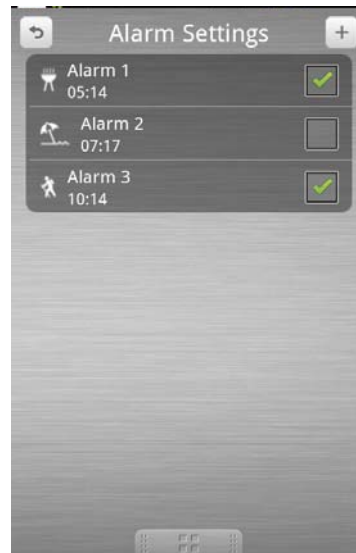

- 5 Set the alarm time, and tap [Save](Save) on the top right of the screen.



↳ The new alarm is saved and displayed on the screen.



#### Tip

- You can set an alarm for your favorite outdoor sport with weather specified. Go to [Lifestyle](Lifestyle) to select your sport and preferred weather(excellent, good, or fair).The alarm won't ring if the weather is not good enough.
- You can go to [Sound](Sound), and select your favorite music as your alarm sound.

# 6 Product information

## Note

- Product information is subject to change without prior notice.

## Specifications

### Amplifier

Amplifier	
Rated Output Power:	2X15 W
Signal to Noise Ratio:	80 dBA
Aux in:	0.6 -1V, 10 kohm

### General information

General information	
System requirements	Android operation system(Version 2.1 or above); bluetooth software(Version 2.1 or above); a micro USB connector.
AC power (power adaptor):	OH-1065A1803500U2 (Phillips), Input: 100-240V~50/60Hz 800mA MAX, Output: 18V = 3.5A
Operation Power Consumption:	28W
Eco Standby Power Consumption:	<1W

Charging:	maximum 2A
-Only through rear USB	2A
-Only through micro USB	2A
-though micro USB and rear USB	1A for each

Dimensions - Main Unit (W x H x D): 429 X 169 X 108 mm

Weight - Main Unit: 2.1kg

If the micro USB connector is located at the top, and your are using Android system of 2.3 or above, screen auto-rotation will be available.

# 7 Troubleshooting



## Warning

- Never remove the casing of this apparatus.

To keep the warranty valid, never try to repair the system yourself.

If you encounter problems when using this apparatus, check the following points before requesting service. If the problem remains unsolved, go to the Philips web site ([www.philips.com/welcome](http://www.philips.com/welcome)). When you contact Philips, ensure that the apparatus is nearby and the model number and serial number are available.

### No power

- Ensure that the AC power adaptor of the unit is connected properly.
- Ensure that there is power at the AC outlet.
- Ensure that the batteries are inserted correctly.

### No sound

- Adjust the volume.

### Clock/timer setting erased

- Power has been interrupted or the power plug has been disconnected.
- Reset the clock/timer.

Philips Consumer Lifestyle  
A division of Philips Electronics North America Corporation  
P.O. Box 10313  
Stamford, CT 06904  
Phone: 1-888-PHILIPS (744-5477)

Meet Philips at the Internet  
<http://www.philips.com/welcome>

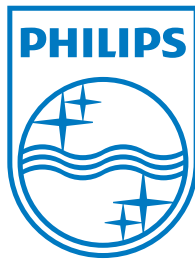

Specifications are subject to change without notice  
© 2011 Koninklijke Philips Electronics N.V.  
All rights reserved.

AS851\_CCR\_37\_V1.0

