

User's Manual

ENW-9801
ENW-9802

PCI-E Dual / Single Port 10 Gigabit Ethernet Adapter



Copyright

Copyright © PLANET Technology Corp. 2012. All rights reserved. No part of this publication may be reproduced, transmitted, transcribed, stored in a retrieval system, or translated into any language or computer language, in any form or by any means, electronic, mechanical, magnetic, optical, chemical, manual or otherwise, without the prior written permission of PLANET.

PLANET makes no representations or warranties, either expressed or implied, with respect to the contents hereof and specifically disclaims any warranties, merchantability or fitness for any particular purpose. Any software described in this manual is sold or licensed "as is". Should the programs prove defective following their purchase, the buyer (and not PLANET, its distributor, or its dealer) assumes the entire cost of all necessary servicing, repair, and any incidental or consequential damages resulting from any defect in the software. Further, PLANET reserves the right to revise this publication and to make changes from time to time in the contents hereof without obligation to notify any person of such revision or changes.

All brand and product names mentioned in this manual are trademarks and/or registered trademarks of their respective holders.

FCC Caution

This equipment has been tested and found to comply with the limits for a Class B digital device, pursuant to Part 15 of the FCC Rules. These limits are designed to provide reasonable protection against harmful interference when the equipment is operated in a commercial environment. This equipment generates, uses, and can radiate radio frequency energy and, if not installed and used in accordance with the Instruction manual, may cause harmful interference to radio communications. Operation of this equipment in a residential area is likely to cause harmful interference in which case the user will be required to correct the interference at whose own expense.

CE Mark Warning

This is a Class B product. In a domestic environment, this product may cause radio interference in which case the user may be required to take adequate measures.

Revision

User's Manual for PLANET PCI Express Dual / Single Port 10 Gigabit Ethernet Adapter

For Models: ENW-9801 / ENW-9802

Revision: 1.3 (January.2012)

Part No. EM-ENW9801_9802_v1.3 (2080-A14090-003)

Table of Contents

CHAPTER 1	INTRODUCTION	4
1.1	Package Content.....	4
1.2	Features	4
1.3	Gathering Tools and Documentations	4
CHAPTER 2	HARDWARE INSTALLATION	5
2.1	LED Definitions.....	5
2.2	Hardware Installation.....	6
CHAPTER 3	DRIVER INSTALLATION	7
3.1	Installing Driver to Windows Server 2003/2003R2	7
3.2	Installing VLAN Support Driver to Windows Server 2003/2003R2	10
CHAPTER 4	SPECIFICATIONS.....	14

Chapter 1 Introduction

Meet the next generation interface - PCI Express dual / single port 10 Gigabit Ethernet adapter can provide the best solution for one of the major issues of Local Area Networks - communication speed. Hundred times as fast as the existing 100Base-TX solutions, using the PLANET ENW-9801 / ENW-9802 to connect your servers and workstations guarantees extremely high throughput and excellent signal quality.

The ENW-9801 / ENW-9802 is a PCI Express dual / single port 10 Gigabit Ethernet adapter designed to address high-performance system application requirements. With the higher bandwidth of x8, x4 PCI Express Bus Architecture, ENW-9801 / ENW-9802 can provide better performance than the network cards which base on 32 / 64bit PCI architecture. It is specifically designed to allow throughput at rates up to 2.5Gbps, thus eliminating the existing 32/64bit PCI network card.

1.1 Package Content

Check that your package contains the following items:

- ✓ **1 x 10G Ethernet Adapter**
- ✓ **1 x Quick Installation Guide**
- ✓ **1 x CD-ROM User's Manual / Driver**
- ✓ **1 x Low Profile Bracket**

Please contact the seller if any of the items is missing or damaged.



Be sure to retain your proof of purchase, as it is required to receive warranty service.

1.2 Features

- Compliant with PCI Express 1.1 – x8 PCI Express standard
- Supports IEEE 802.3ae, IEEE 802.3x, IEEE 802.1Q VLAN.
- Integrated Frame Buffer Memory for Dual TX 32KB and Dual RX 64KB.
- Supports Jumbo Frame up to 16K
- IP, TCP and UDP checksum offload

1.3 Gathering Tools and Documentations

To install the adapter, you need the following items:

- ✓ A suitable screw driver
- ✓ Your operating system documentation
- ✓ Your system unit documentation, including any service documentation

Chapter 2 Hardware Installation

2.1 LED Definitions

The faceplate of ENW-9801 has one LED: Link / ACT. The pictures below have showed the faceplate of ENW-9801. Table 2-1 explains the function and state of the LED.

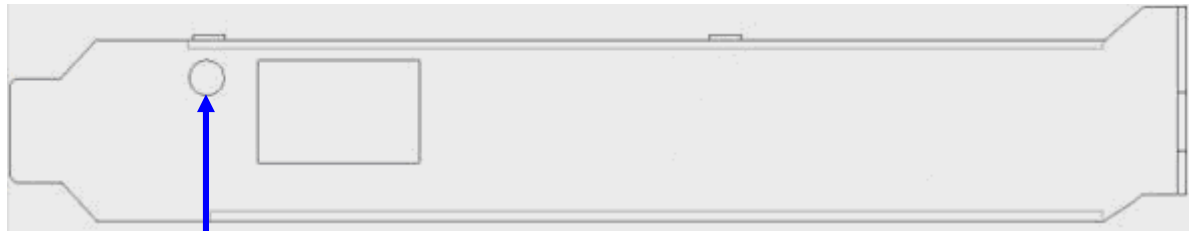

Link / ACT LED



Link / ACT LED

ENW-9801 Long and Low Profile Bracket

The faceplate of ENW-9802 has one LED: Link / ACT. The pictures below have showed the faceplate of ENW-9802. Table 2-1 explains the function and state of the LED.



Link / ACT LED

Link / ACT LED

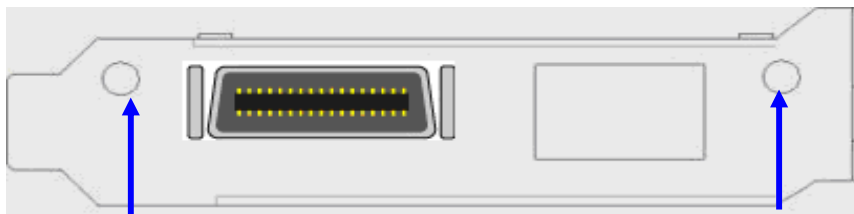

Link / ACT LED

Link / ACT LED

ENW-9802 Long and Low Profile Bracket

LED	Description
Link	Lights to indicate a functional network link through the port.
ACT	Blinks to indicate data has been sending and receiving via the port.

Table 2-1 Descriptions of ENW-9801 / ENW-9802 LED

2.2 Hardware Installation

- Step 1:** Please turn off your PC.
- Step 2:** Remove any metal decorations from your hands and wrists.
- Step 3:** Remove the cover from your PC.
- Step 4:** Locate an empty PCI Express slot and remove the corresponding back plate. Save the screw for use in Step 6.
- Step 5:** Carefully insert the adapter into the chosen slot and press firmly with proper push to ensure it is fully seated in the slot.

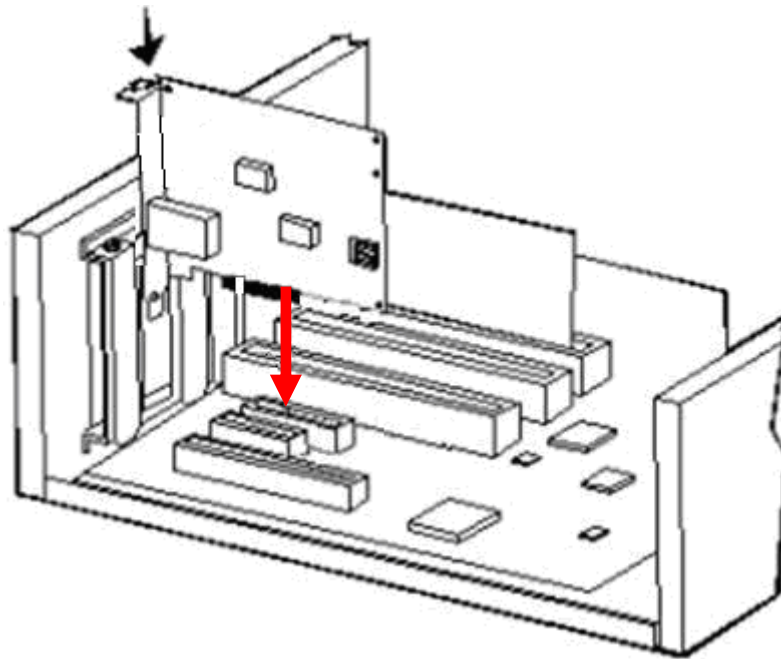

- Step 6:** Secure the adapter with the screw you saved in step 4.
- Step 7:** Replace the PC cover.
- Step 8:** Power on the PC and refer to next chapter to install the driver of this adapter.

Chapter 3 Driver Installation

A device driver must be installed before your ENW-9801 / ENW-9802 can be used with your computer. This chapter describes how to install the driver for various operating systems. Before you begin the driver installation process, make sure you have the installation disks for your computer's operation system.

3.1 Installing Driver to Windows Server 2003/2003R2



*The following installation uses ENW-9801 and operates under Window2003R2.
The ENW-9802 installation procedure is the same with ENW-9801.*

1. Install ENW-9801 into your PC's PCI Express slot.
2. Power on the PC and insert Driver Disk into CD-ROM drive.
3. Windows 2003R2 will detect ENW-9801 and ask you to install driver. Please select the second option and click "**Next**".



4. Please select "**Include this location in the search**" and then click "**Browse**" to specify ENW-9801 driver location to install. (Assume "E" is your CD-ROM drive, you can find ENW-9801 driver in E:\planet_NIC10G\3.23\drivers\ENW-9801\W2003R2). Please click "**Next**" to continue.

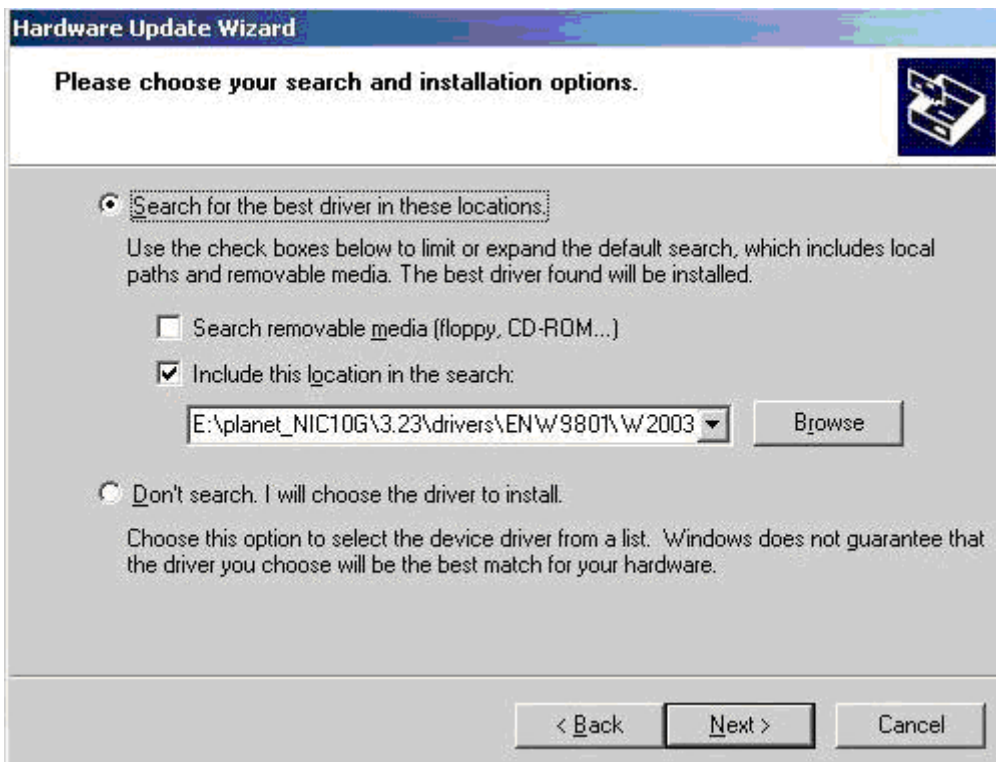

5. Win2003R2 will show you this dialog box to prompt you the driver is not digitally signed by Microsoft, please press "**Continue Anyway**" to continue.



6. Please click “**Finish**” to complete the driver installation.

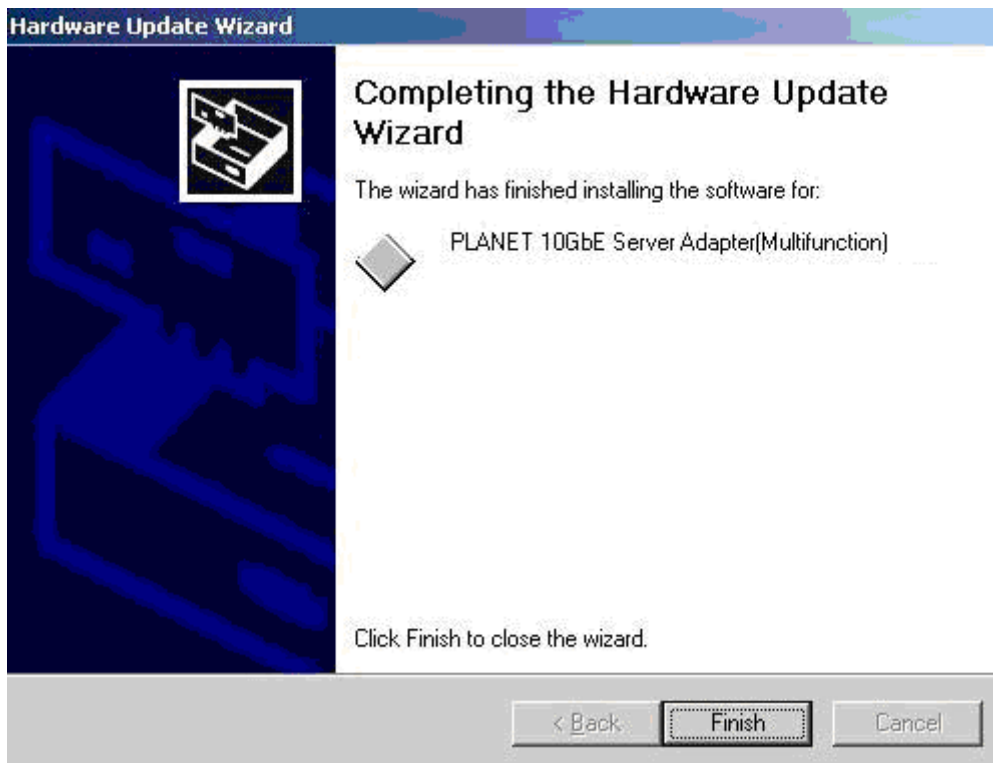

3.2 Installing VLAN Support Driver to Windows Server 2003/2003R2



The following installation uses ENW-9801 and operates under Window2003R2.

The ENW-9802 installation procedure is the same with ENW-9801.

1. Open Network Connection properties by Start\Settings\Control Panel\Network Connections then click “**Install**” Button.

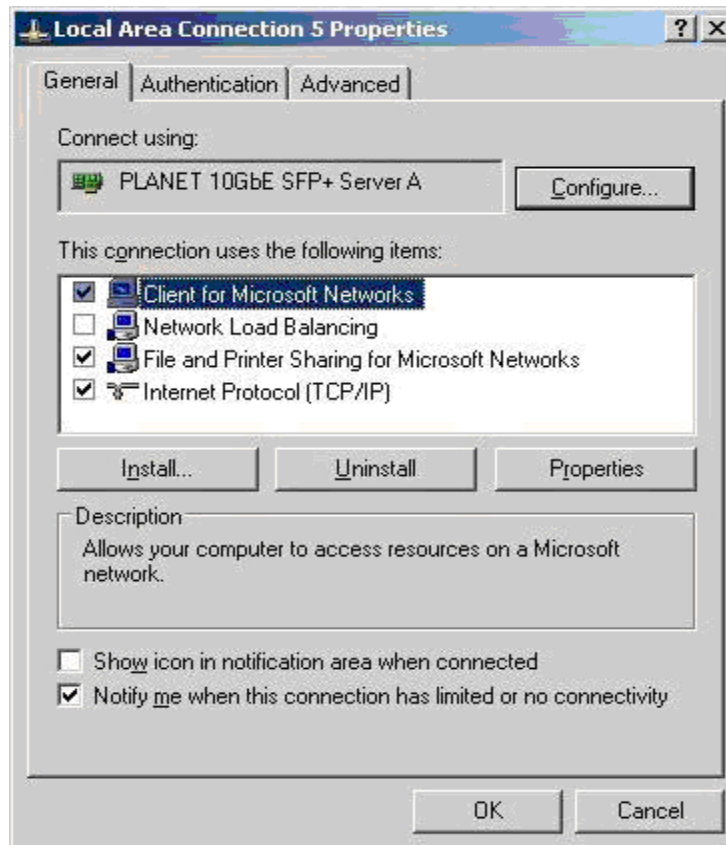

2. Select "Protocol" and click "Add" button

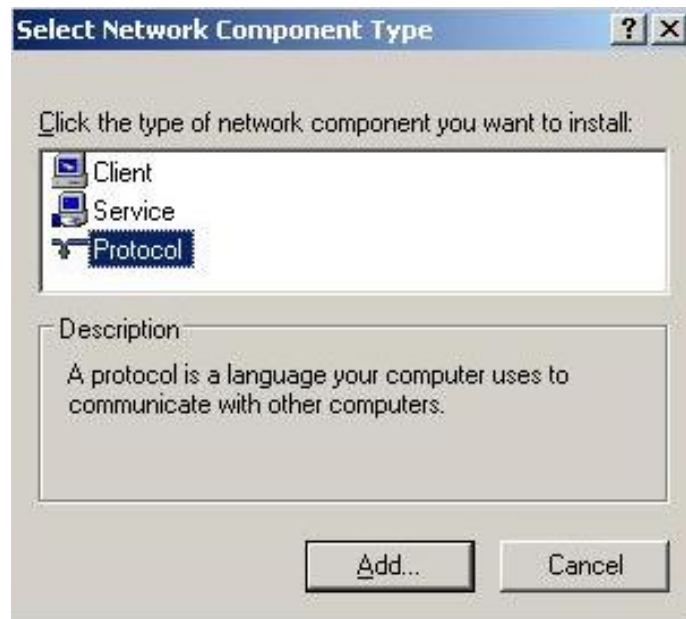

3. In "Select Network Protocol" window click "Have Disk" Button



4. Press "Browse" to specify ENW-9801 VLAN driver location to install. (Assume "E" is your CD-ROM drive, you can find ENW-9801 driver in E:\planet_NIC10G\3.23\tools\vlan\W2003). Please click "OK" to continue.

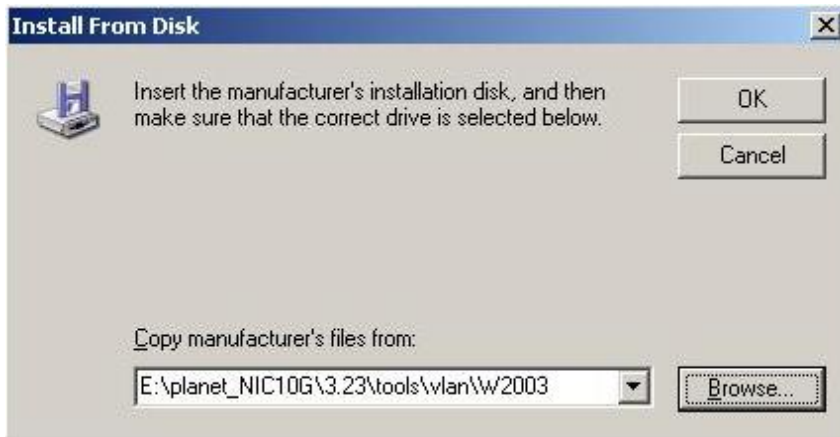

5. In "Select Network Protocol" window select "PLANET 10GbE Server Adapter VLAN Protocol Driver"

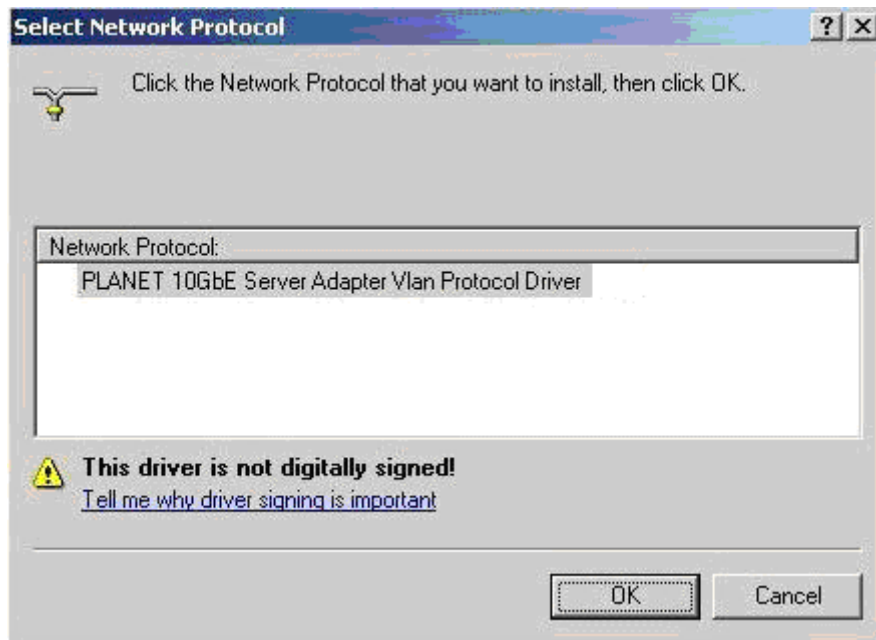

6. Win2003R2 will show you this dialog box to prompt you the driver is not digitally signed by Microsoft, Please press "**Continue Anyway**" to continue.



7. Wait a moment or more until "Select Network Protocol" window is closed and installation is completed

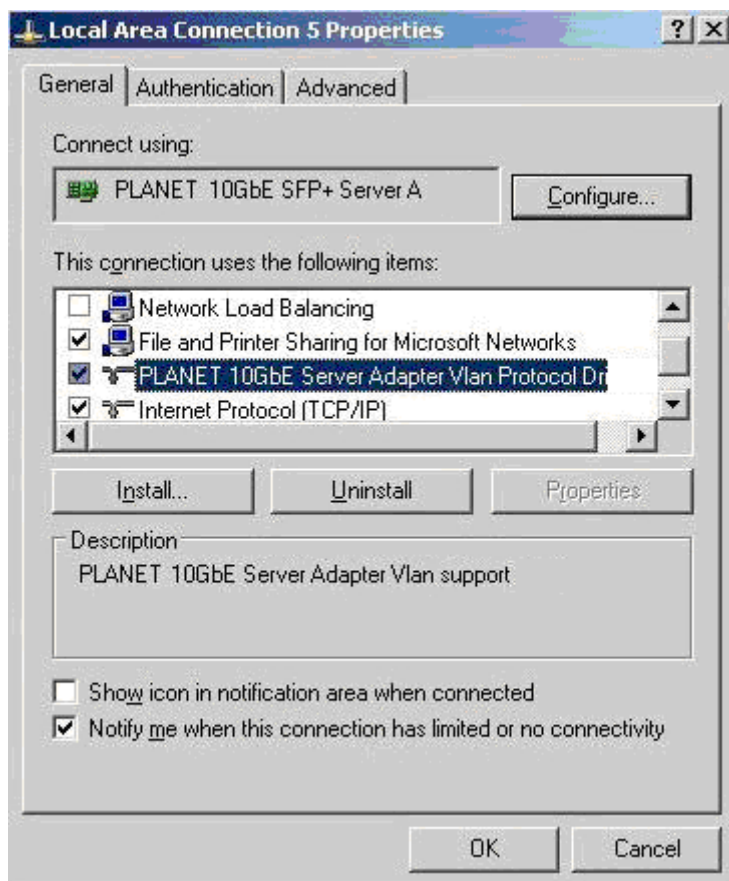

Chapter 4 Specifications

Product	ENW-9801	ENW-9802
Hardware Specification		
Attachment Interface	PCI Express Host Bus Interface, 8 lanes / 4 lanes PCI Express Rev 1.1a	
Media Interface	1 SFP+	1 SFP+ 1 CX4
Optical Module Options	LRM, LR, SR	
Memory	3Mb internal memory	
Jumbo Frame	9K / 16Kbytes	
LED Indicators	Link / Active per port	
Typical Power Dissipation	9 Watts	
Dimension (W x D)	147 x 63.5mm	
Advanced Function		
Layer 2 Features	<ul style="list-style-type: none"> • IEEE 802.3x Flow Control support • IEEE 802.1Q VLAN support • Multicast ACL 	
Performance enhancements	<ul style="list-style-type: none"> • Microsoft Scalable Networking • Receive-side scaling (RSS): Optimization for multiple CPUs under Windows OS control • Reduced host bus traffic • Optimization for multiple CPUs • IP acceleration • Widely used network protocol • IP, TCP and UDP checksum offloading • Large Send (up to 64 KB): Increased network throughput • IPv4, IPv6 	
OS Support	<ul style="list-style-type: none"> • Windows Server 2003, Windows Server 2008 • Windows XP, Windows Vista™, Windows 7 • Linux 2.4, Linux 2.6, Linux 3.0 Linux 64-bit • Multiple queues management • Windows Management Interface (WMI) 	
Standards Conformance		
Regulation Compliance	FCC Part 15 Class B, CE	
Standards Compliance	IEEE Std 802.3ae: 10Gbps Ethernet IEEE Std 802.3ak: 10Gbps – CX4 IEEE 802.3x: Flow Control and Back pressure IEEE 802.1Q: VLAN Tagging	
Environment		
Operating	Temperature: 0 ~ 65 Degree C Relative Humidity: 5 ~ 95% (non-condensing)	
Storage	Temperature: -10 ~ 85 Degree C Relative Humidity: 5 ~ 95% (non-condensing)	