

Technical & Sizing Bulletin for Meriam LFEs

Laminar Flow Elements

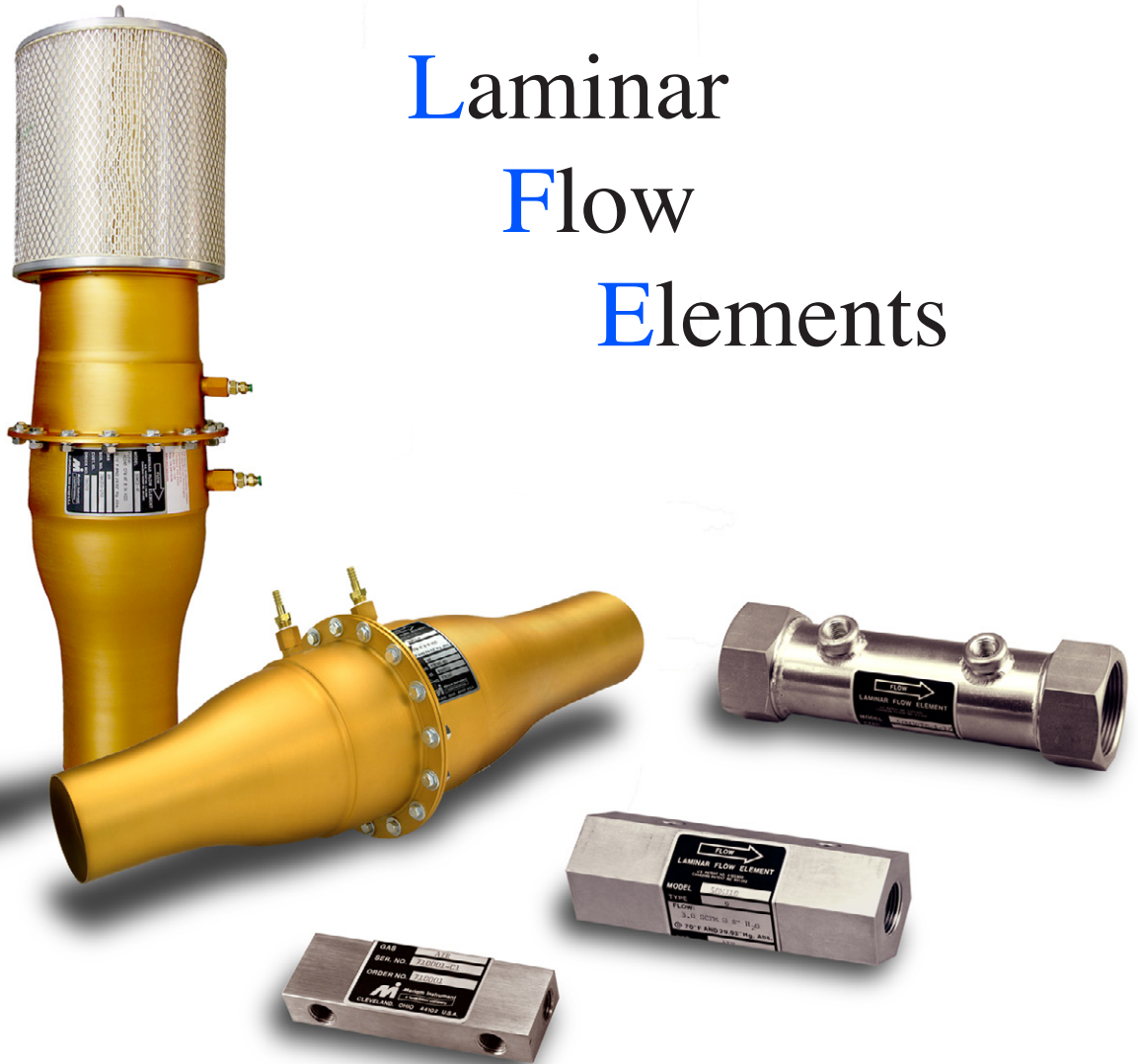

What they are...

Meriam Laminar Flow Elements are gas volume rate of flow differential producers operating on capillary flow principles. They are available in a wide range of types and sizes and are ideally suited to many flow measurement and calibration applications. NIST traceable certificates of calibration from Meriam's ISO 17025 Flow Lab are standard.

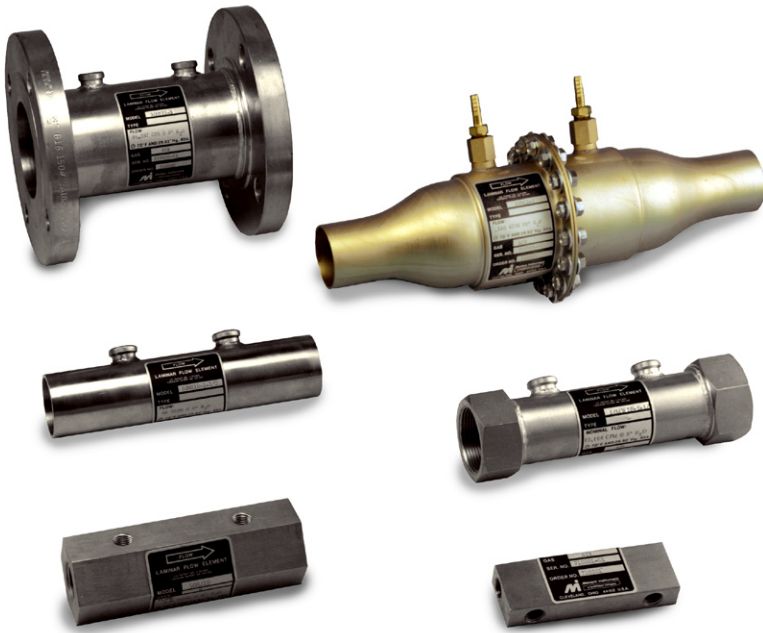

LFEs are applicable over wider flow ranges than conventional types of differential producers. The fact that their flow versus differential pressure curve approaches linearity makes this wider range possible. In many applications one Meriam LFE can cover a range of flow which would otherwise require several venturis, nozzles or orifice plates. Their low range accuracy is limited only by the flow stability and the readability of the differential pressure sensing instrument. The selection of readout or secondary instrumentation is most important in the overall performance and installed accuracy of Meriam LFEs.

Some typical applications of Meriam LFEs include: combustion air flow to internal combustion engines, fan and blower calibration, leak testing, cylinder head port air flow, and testing of automobile components. LFE's are also used to calibrate other flow metering devices such as variable area meter, thermal anemometers, orifices, nozzles, etc. Contact us for application assistance.

Standard LFE calibration accuracy is $\pm 0.72\%$ to $\pm 0.86\%$ of Reading (not % of Full Scale; See Fig. 1) traceable to the National Institute of Standards and Technology (NIST). Special calibration accuracy of $\pm 0.5\%$ of Reading or better is optional. Rigid construction and lack of any moving parts make the LFE calibration stable. Only physical damage or particulate deposition in the element will cause a calibration shift. Cleaning and recalibration is typically recommended every 12 to 18 months.

The nearly linear relationship between produced differential pressure (DP) and flow rate results in impressive turndown ratios of 20:1, 50:1 or even greater depending largely on the accuracy and resolution of the

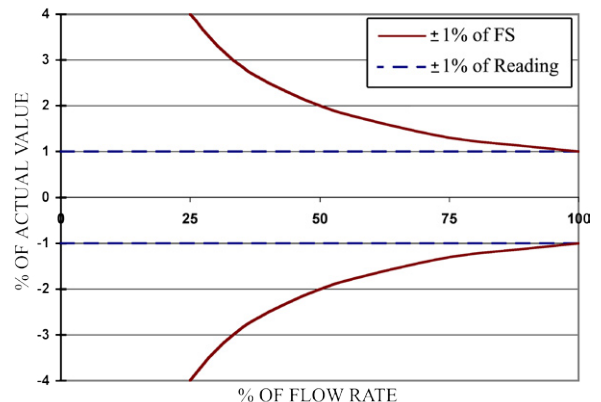

Fig. 1. Compare % FS to % Reading

Standard models are available to measure as little as 0.2 SCCM (5.9 E-06 SCFM) to as much as 2250 SCFM of air flow at standard conditions. Custom models for as much as 15,000 SCFM of air are available. Stainless steel or aluminum materials make LFEs compatible with most gases. Flow rate of gas mixtures can also be measured provided the percentages of component gases and mixture properties are known.

How they work...

Laminar Flow Elements are designed to take advantage of the Hagen-Poiseuille relationship for energy loss under laminar flow conditions. In simplified terms, this relationship states that if a flow tube or capillary has small enough diameter relative to its length, the difference in pressure between the tube's inlet and outlet will be linearly proportional to the flow rate through the tube. Flow in the gas supply pipe may be turbulent, transitional, or laminar. By using small capillaries, either individually or in a bundle (or matrix), the LFEs induce laminar flow through each capillary. Combining this feature with a sufficient capillary length results in a nearly linear relationship between DP and flow rate.

LFEs are viscosity dependent devices. When laminar flow exists, the fluid tends to behave as if it were divided into layers. Since viscosity is a measure of a fluid's resistance to change of shape, then as layers of fluid move over each other, system energy is lost due to friction between the layers. The system energy loss is observed as DP across the inlet and outlet of the LFEs matrix. Due to the dependence of the DP on viscosity (a function of temperature and gas media) and the velocity of the flowing gas, LFEs measure actual volumetric flow rate. This makes it necessary to measure gas temperature and inlet pressure in order to calculate mass or standard volumetric flow rates.

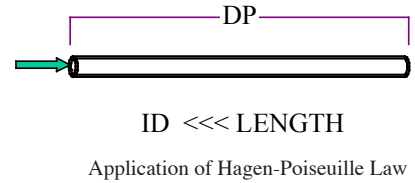

Laminar Flow Elements can be fabricated from several materials. Housings are typically stainless steel or aluminum and serve to hold the matrix of capillaries together in a stable configuration. They also provide process and DP connections. Process connections are available in tapered thread, straight thread with O-ring, VCO, hose or flange varieties. DP connections are made via tapered thread, straight thread with O-ring or hose barbs. The LFE matrix can be made from individual stainless steel tubes or windings of stainless steel foil. More exotic materials may be available when fluid compatibility is a concern.

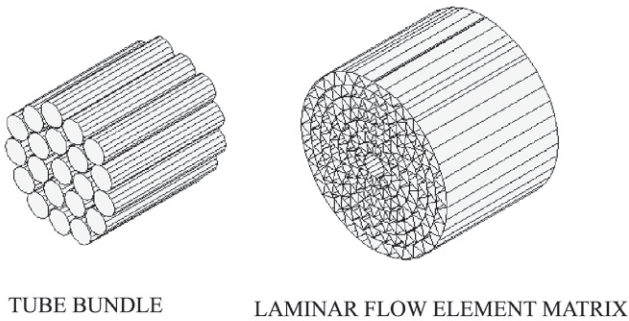

The DP generated across the matrix responds quickly – within 16 milliseconds – to changes in flow velocity. Response time of the meter (LFE and readout device) is generally limited to the capabilities of the DP readout device.

Permanent pressure loss is associated with LFE use. Since the DP across the LFE matrix is a measure of system energy lost to overcoming friction between laminar flow layers, all produced DP is permanently lost pressure. This is usually not a problem, however, due to the way LFEs are sized. Full scale flow rates are limited so that 8 to 10 inches of water column is the maximum DP produced. When even less permanent loss can be tolerated, an LFE can be oversized to produce less DP at the required flow rate or the correct size LFE can be made with a shortened matrix length.

The Meriam Matrix... the heart of the element

Meriam LFEs channel flow through a myriad of minute parallel capillary passages. Velocity is maintained at about the same as in the supply pipe. The capillary dimension is reduced sufficiently to produce laminar flow from the normally occurring turbulent gas stream. The drawings above represent end views of the “matrix” at the heart of Meriam LFEs. Each round or triangular shaped passage measures only a few thousandths of an inch in effective diameter while measuring several inches in length. They are therefore considered to be “capillary” passages.

As a gas flows through the matrix, friction created causes a pressure drop. The amount of this drop is determined by measuring the pressure differential across the matrix. The stainless steel matrix is formed and fused into a mechanically rigid unit. This geometric integrity provides permanent calibrations; there are no moving parts. Only deposition of particles or physical damage to the matrix will cause calibration shift.

In some smaller sizes of Meriam LFEs, bundles of capillary tubes are used instead of a matrix.

Differential Pressure and Pressure Loss

Meriam LFEs are normally rated for maximum flow at 4 or 8 inches of water differential. There is no recovery of pressure differential from a Laminar Flow Element matrix. Filters and inlet and outlet configurations increase the total pressure drop and must be considered when pressure loss considerations are critical.

Model	Metering Pressure Drop at Full Flow (in inches of water)	Total Pressure Drop at Full flow (in inches of water)
50MK10 / 50MT10	4	4
50MJ10 / 50MT10	8	8
50MW20 / 50MT20	8	8
50MH10	8	8
50MY15	8	8
50MR2 or 50MC2	8	12
50MR2-F or 50MC2-F	8	12

How To Size Laminar Flow Elements

To determine the proper size of a Laminar Flow Element it is necessary to determine the flow range in equivalent standard cubic feet per minute (SCFM*) of air. The range is then compared to SCFM* ranges shown on Page 8. Follow one of the four examples below.

I. AIR FLOW IN SCFM AT STANDARD CONDITIONS OF 29.92" Hg. Abs. AND 70°F.

When the flowing gas is air and the operating pressure and temperature are at 29.92" Hg. Abs. and 70°F (standard conditions), the Laminar Flow Element can be selected directly from the capacity chart.

SCFM = Standard cubic feet per minute.

ACFM = Actual cubic feet per minute.

CFM = Cubic feet per minute.

NOTE:

SCFM	=	ACFM	=	CFM
at		at		at
29.92"		29.92"		29.92"
Hg. Abs.		Hg. Abs.		Hg. Abs.
70°F		70°F		70°F

II. AIR OR GAS FLOW IN SCFM AT OTHER THAN 29.92" Hg. Abs. AND 70°F.

When the flow is given in another standard of SCFM of air or some other gas, and the operating pressure and temperature are not at 29.92" Hg. Abs. and 70°F, then the equivalent SCFM air flow at 29.92" Hg. Abs. and 70°F must be computed as though the laminar flow element were flowing air under (Meriam) standard conditions. To do this, use the equation below:

SCFM* = The equivalent amount of air in SCFM, if the flowing conditions were air, flowing through the Laminar Flow Element under a pressure of 29.92" Hg. Abs. and at 70°F (Meriam standard conditions).

SCFM = Standard Cubic Feet per Minute of gas referenced to base conditions of 70°F and 29.92" Hg. Absolute.

Pg = Pressure of the flowing gas in inches Hg. Abs.

Tg = Temperature of the flowing gas in degrees Rankin (°R).

(°R = 460 + Temperature in °F)

μg = Viscosity of the gas at the flowing temperature, in micropoise

$$SCFM^* = SCFM \times \frac{29.92}{P_g} \times \frac{T_g}{530} \times \frac{\mu_g}{181.87}$$

III. AIR OR GAS FLOW IN ACFM OR CFM UNITS.

When the air or gas flow is given in other than SCFM*, then the SCFM value must be computed from the equations below. The sizing of a laminar flow element can then proceed as in Example 2.

1. Cubic Feet per Minute (CFM)

$$SCFM = 17.714 * CFM \frac{(P_g)}{(T_g)}$$

or Actual Cubic Feet per Minute (ACFM)

$$SCFM = 17.714 * ACFM \frac{(P_g)}{(T_g)}$$

2. Standard Cubic Centimeters per Minute (SCCM)

$$SCFM = \frac{SCCM}{28316}$$

3. Standard Liters per Minute (SLPM)

$$SCFM = \frac{SLPM}{28.316}$$

4. Pounds per Minute (PPM)

$$SCFM = \frac{PPM}{\text{Density}^{**}}$$

5. Pounds per Hour (PPH)

$$SCFM = \frac{PPH}{60 \times \text{Density}^{**}}$$

$$*17.714 = \frac{530}{29.92} = \frac{T \text{ Std.}}{P \text{ Std.}}$$

** At standard conditions (29.92" Hg. Abs. & 70°F)

IV. OBSERVANCE OF REYNOLD'S NUMBER FOR THE LAMINAR FLOW ELEMENT SELECTED.

To maintain laminar flow with linearity through the LFE, consideration must be given to The Reynolds number for the maximum flow condition. Meriam LFEs will produce linear flow characteristics when the Reynolds number is 150 at 4" differential and 300 at 8" differential.

It should be pointed out that true linearity will not be retained at elevated Reynolds number. However, a calibration made at the operating condition will be fully usable and repeatable.

To calculate the approximate Reynolds number for the LFE selected, use the equation:

$$R_D = \frac{228 S_g P_g \text{ Diff.}}{\mu_g}$$

R_D = Reynold's Number

S_g = Specific gravity of the flowing gas (based on air = 29)

P_g = Pressure of the flowing gas in inches Hg. Abs.

Diff = Differential pressure calculated for the laminar flow element selected

μ_g = Viscosity of the gas at the flowing temperature, in micropoise

Calculation of R_D for conditions as presented in example 2:

$$R_D = \frac{228 \times 0.138 \times 32.78 \times 6.545}{201.13} = 35.8$$

Basic Sizing Equation

$$SCFM^* = ACFM \times \frac{\mu g}{181.87}$$

OR

$$SCFM^* = SCFM \times \frac{29.9}{Pg} \times \frac{Tg}{530} \times \frac{\mu g}{181.87}$$

EXAMPLE 1:

Select a Laminar Flow Element for the following conditions:

The gas flowing is AIR at a flow rate of 15 SCFM.

The pressure of the flowing AIR is 29.92" Hg. Abs.

The temperature of the AIR is 70°F.

Since this flow is at standard condition, the Laminar Flow Element can be selected directly from the capacity chart.

The Laminar Flow Element selected in this example would be a Model 50MW20-1½.

To compute the approximate differential pressure that this selection would develop, use the equation:

Diff. Pressure =

$$SCFM \text{ (calculated)} \times \frac{\text{Diff. Pressure}^*}{SCFM}$$

* Catalog Rating for Laminar Flow Element Selected

For the above example

Diff. Pressure =

$$15 \times \frac{8}{22} = 5.454'' \text{ H}_2\text{O Differential}$$

A check should be made for Laminar Flow by calculating the Reynold's Number. See section IV.

EXAMPLE 2:

Select a Laminar Flow Element for the following conditions:

The gas flowing is HELIUM at a flow rate of 1.25 SCFM.

The pressure of the HELIUM gas is 1.4 PSIG (=32.781" Hg. Abs.)

The temperature of the HELIUM is 90°F (=550°R)

The viscosity of HELIUM @ 90°F is 201.13 micropoise.

From the Basic Sizing Equation, calculate the **equivalent** SCFM* air flow as:

$$SCFM^* = 1.25 \times \frac{29.92}{32.78} \times \frac{550}{530} \times \frac{201.13}{181.87} = 1.309$$

Upon examining the ratings for the various Laminar Flow Elements we can see that the Model 50MJ10-10 will handle this flow since it is rated at 1.6 SCFM* @ 8" H₂O differential pressure.

A check should be made for Laminar Flow by calculating the Reynold's Number. See Section IV.

Gas Properties at standard conditions of 29.92" Hg. Abs. and 70°F			
Gas	Density (lb/ft ³)	μ Viscosity Micropoises	Specific Gravity
Air	0.0749	181.87	1.000
Argon	0.1034	225.95	1.380
Helium	0.0103	193.9	0.138
Hydrogen	0.0052	88.41	0.0695
Nitrogen	0.0725	175.85	0.968
Oxygen	0.0828	203.47	1.105
Carbon Dioxide	0.1143	146.87	1.526

NOTE: Ref. NBS Technical Note 564 for Gas Viscosity Data

EXAMPLE 3:

Select a Laminar Flow Element for the following conditions:

The gas flowing is HELIUM at a flow rate of 1.184 ACFM.

The pressure of the HELIUM gas is 1.4 PSIG (=32.781" Hg. Abs.)

The temperature of the HELIUM is 90°F (=550°R)

The viscosity of HELIUM @ 90°F is 201.13 micropoise.

From the Basic Sizing Equation equation for actual cubic feet per minute, calculate the **equivalent** SCFM* air flow as:

$$SCFM^* = 1.184 \times \frac{201.13}{181.87} = 1.309$$

Using this value, proceed to select and LFE as in Example 2.

EXAMPLE 4:

Select a Laminar Flow Element for the following conditions:

The gas flowing is ARGON at a flow rate of 0.9 SCFM.

The pressure of the flowing ARGON is 20 psig (=70.64" Hg Abs.).

The temperature of the ARGON is 60°F (=520°R).

The viscosity of ARGON at 60° F is 222.51 micropoise.

The specific gravity of ARGON at standard conditions is 1.380.

From our equivalent air flow equation (See Section II):

$$SCFM^* = .09 \times \frac{29.92}{70.64} \times \frac{520}{530} \times \frac{222.51}{181.87} = .458$$

This flow rate could be determined by Model 50MJ10-11 which has a rating of 0.7 SCFM* @ 8" H₂O.







The differential pressure expected would be equal to:

$$\text{Diff. pressure} = .458 \times \frac{8}{0.7} = 5.23'' \text{ H}_2\text{O}$$

If we now compute the Reynold's number for these conditions we find that:

$$RD = \frac{228 \times 1.380 \times 70.64 \times 5.23}{222.51} = 522$$

This Reynold's Number is too high even though the flow rate calculation gives us an acceptable differential pressure. Therefore, we will have to size the LFE with a larger size, or the Model 50MJ10 Type 10. The same calculations will give us a differential of approximately 2.29 and a Reynold's Number of 228. This model would be acceptable for the application.

Model Number & Description		Line Size	NPT tapered thread	FISO 7/1 tapered thread	SAE J1926 straight thread w/ O-ring	DIN3852 Part 2 straight thread w/ O-ring
 <p>50MK10 Utilizes stainless steel capillary tubes cemented into a stainless steel body. Inlet, outlet and differential pressure connections are 1/4".</p>	1/4"	50MK10-8	50MK10-8MT	50MK10-8S	50MK10-8MS	
	1/4"	50MK10-7	50MK10-7MT	50MK10-7S	50MK10-7MS	
	1/4"	50MK10-6	50MK10-6MT	50MK10-6S	50MK10-6MS	
	1/4"	50MK10-5	50MK10-5MT	50MK10-5S	50MK10-5MS	
	1/4"	50MK10-4	50MK10-4MT	50MK10-4S	50MK10-4MS	
	1/4"	50MK10-3	50MK10-3MT	50MK10-3S	50MK10-3MS	
	1/4"	50MK10-2	50MK10-2MT	50MK10-2S	50MK10-2MS	
	1/4"	50MK10-1	50MK10-1MT	50MK10-1S	50MK10-1MS	
 <p>Model 50MJ10 All stainless steel unit with fused matrix. Differential pressure connections are 1/4". Line connections 1/2" NPT, except Type 9 which has 3/4" NPT.</p>	1/2"	50MJ10-14	50MJ10-14MT	50MJ10-14S	50MJ10-14MS	
	1/2"	50MJ10-13	50MJ10-13MT	50MJ10-13S	50MJ10-13MS	
	1/2"	50MJ10-12	50MJ10-12MT	50MJ10-12S	50MJ10-12MS	
	1/2"	50MJ10-11	50MJ10-11MT	50MJ10-11S	50MJ10-11MS	
	3/4"	50MJ10-9	50MJ10-9MT	50MJ10-9S	50MJ10-9MS	
 <p>50MW20 All stainless steel welded unit with fused matrix. Line connections are threaded. Differential pressure connections are 1/4".</p>	1"	50MW20-1	50MW20-1MT	50MW20-1S	50MW20-1MS	
	1 1/2"	50MW20-1 1/2	50MW20-1 1/2MT	50MW20-1 1/2S	50MW20-1 1/2MS	
	2"	50MW20-2	50MW20-2MT	50MW20-2S	50MW20-2MS	
 <p>50MH10 All stainless steel welded unit with fused matrix. Line connections are tapered ends (no threads) for hose connection. Differential pressure connections are 1/4" NPT.</p>	1"	50MH10-1	----	----	----	
	1 1/4"	50MH10-1 1/4	----	----	----	
	1 1/2"	50MH10-1 1/2	----	----	----	
	2"	50MH10-2	----	----	----	
	3"	50MH10-3	----	----	----	
	4"	50MH10-4	----	----	----	
	5"	50MH10-5	----	----	----	
	6"	50MH10-6	----	----	----	
	8"	50MH10-8 (x)	----	----	----	
10"	50MH10-10 (x)	----	----	----		
 <p>50MY10 All stainless steel welded unit with fused matrix. Line connections are 150 lb ANSI flanges. Differential pressure connections are 1/4" NPT.</p>	2 1/2"	50MY15-2 1/2	----	----	----	
	3"	50MY15-3	----	----	----	
	4"	50MY15-4	----	----	----	
	5"	50MY15-5	----	----	----	
	6"	50MY15-6	----	----	----	
	8"	50MY15-8 (x)	----	----	----	
	10"	50MY15-10 (x)	----	----	----	
12"	50MY15-12 (x)	----	----	----		
 <p>50MR2 Aluminum housing for low pressure applications. Line connections are 150 lb ANSI flanges. Differential pressure connections 1/4" hose barb.</p>	2"	50MR2-2	----	----	----	
	4"	50MR2-4	----	----	----	
	6"	50MR2-6	----	----	----	
	8"	50MR2-8	----	----	----	
 <p>50MC2 Aluminum housing for low pressure applications. Inlet and outlet are for hose type connections. Differential pressure connections 1/4" hose barb.</p>	2" I.D.	50MC2-2	----	----	----	
	4" I.D.	50MC2-4	----	----	----	
	6" I.D.	50MC2-6	----	----	----	
	8" I.D.	50MC2-8	----	----	----	

NOTES:

1. The flows and differential pressure rating of production units are subject to a variation of plus or minus 10% from the nominal values listed above.
2. Each LFE unit is calibrated with air to Meriam flow standards which are traceable to the National Bureau of Standards. Meriam calibration flow curves are furnished with each unit.
3. A special service is available for those Meriam LFE units which are governed by quality programs requiring periodic recalibration. The Special Calibration Procedure A-33544 is designed to meet the basic requirements of 10CFR50, ANSI-Z540-I & ML-Q-9858A. Contact Meriam direct for information.

Nominal Air Flow Range (29.92" Hg. Abs. & 70°F)		Max. DP In. H ₂ O	Pipe Size	Nominal Air Flow Range 760 MM Hg. Abs. & 21.1°C)			Max DP MM H ₂ O
SCFM*	PPM			CC/MIN*	LPM*	Kg/M	
0.00019	1.42 x 10 ⁻⁵	4"	1/4"	5.38	0.00538	6.44 x 10 ⁻⁶	101.6
0.00062	4.64 x 10 ⁻⁵	4"	1/4"	17.5	0.0175	2.10 x 10 ⁻⁵	101.6
0.000124	9.28 x 10 ⁻⁵	4"	1/4"	35.1	0.0351	4.21 x 10 ⁻⁵	101.6
0.0025	1.87 x 10 ⁻⁴	4"	1/4"	70.8	0.0708	8.48 x 10 ⁻⁵	101.6
0.0046	3.45 x 10 ⁻⁴	4"	1/4"	130	0.130	1.56 x 10 ⁻⁴	101.6
0.0081	6.07 x 10 ⁻⁴	4"	1/4"	229	.229	2.75 x 10 ⁻⁴	101.6
0.0149	0.00112	4"	1/4"	422	.422	5.06 x 10 ⁻⁴	101.6
0.046	0.00344	4"	1/4"	1300	1.30	0.00156	101.6
0.10	0.00749	8"	1/2"	2830	2.83	0.00339	203.2
0.18	0.0135	8"	1/2"	5100	5.10	0.0061	203.2
0.38	0.0285	8"	1/2"	10700	10.8	0.0129	203.2
0.70	0.0524	8"	1/2"	19800	19.8	0.0237	203.2
1.60	0.120	8"	1/2"	45300	45.3	0.0543	203.2
3.00	0.225	8"	3/4"	85000	85.0	0.102	203.2
7.5	0.562	8"	1"	2.12 x 10 ⁵	212	0.254	203.2
22	1.65	8"	1 1/2"	6.23 x 10 ⁵	623	0.746	203.2
40	3.00	8"	2"	1.13 x 10 ⁶	1130	1.357	203.2
7.5	0.562	8"	1"	2.12 x 10 ⁵	212	0.254	203.2
16	1.20	8"	1 1/4"	4.53 x 10 ⁵	453	0.543	203.2
23	1.72	8"	1 1/2"	6.51 x 10 ⁵	651	.780	203.2
40	3.00	8"	2"	1.13 x 10 ⁶	1130	1.35	203.2
90	6.74	8"	3"	2.55 x 10 ⁶	2550	3.05	203.2
160	12.0	8"	4"	4.53 x 10 ⁶	4530	5.43	203.2
250	18.7	8"	5"	7.08 x 10 ⁶	7080	8.48	203.2
360	27.0	8"	6"	1.02 x 10 ⁷	10200	12.2	203.2
640	47.9	8"	8"	1.81 x 10 ⁷	18100	21.7	203.2
1000	74.9	8"	10"	2.83 x 10 ⁷	28300	33.9	203.2
1440	108	8"	12"	4.07 x 10 ⁷	40800	48.8	203.2
2250	168	8"	16"	6.37 x 10 ⁷	63700	76.3	203.2
60	4.50	8"	2 1/2"	1.69 x 10 ⁶	1700	2.03	203.2
90	6.74	8"	3"	2.55 x 10 ⁶	2550	3.05	203.2
160	12.0	8"	4"	4.53 x 10 ⁶	4530	5.43	203.2
250	18.7	8"	5"	7.08 x 10 ⁶	7080	8.48	203.2
360	27.0	8"	6"	1.02 x 10 ⁷	10200	12.2	203.2
640	47.9	8"	8"	1.81 x 10 ⁷	18100	21.7	203.2
1000	74.9	8"	10"	2.83 x 10 ⁷	28300	33.9	203.2
1440	108	8"	12"	4.07 x 10 ⁷	40800	48.8	203.2
2250	169	8"	16"	6.37 x 10 ⁷	63700	76.6	203.2
100	7.49	8"	2"	2.83 x 10 ⁶	2830	3.39	203.2
400	30.0	8"	4"	1.13 x 10 ⁷	11300	13.6	203.2
1000	74.9	8"	6"	2.83 x 10 ⁷	28300	33.9	203.2
2250	168	8"	8"	6.37 x 10 ⁷	63700	76.3	203.2
100	7.49	8"	2" I.D.	2.83 x 10 ⁶	2830	3.39	203.2
400	30.0	8"	4" I.D.	1.13 x 10 ⁷	11300	13.6	203.2
1000	74.9	8"	6" I.D.	2.83 x 10 ⁷	28300	33.9	203.2
2250	168	8"	8" I.D.	6.37 x 10 ⁷	63700	76.3	203.2

4. The catalog capacities refer to the following base conditions:



Air, 29.92" Hg Abs., 70° F, 181.87 micropoise.

Base Reynold's Number: 300 at 8" H₂O, 150 at 4" H₂O.

5. SCFM* - Equivalent air flow at base conditions listed above.

6. All units are offered with optional integral filter on inlet side except those marked (x). Removal or replacement of filter necessitates recalibration.

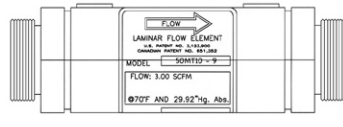
7. Rated flow pressure and temperature for standard units are 30 psig and 150°F to maintain laminar flow, calibration, linearity and accuracy. For higher pressure and temperature rating contact a Meriam Representative, or Meriam Process Technologies direct.

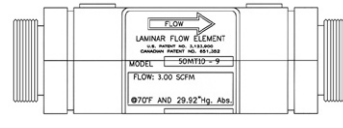
Model Number & Description		Tube Size	UNF x VCO process conn., 1/4" SAE J1926 port, O-ring boss DP conn.	Nominal Air Flow Range (29.92" Hg. Abs. & 70°F)		Max. DP In. H ₂ O	Nominal Air Flow Range 760 MM Hg. Abs. & 21.1°C)			Max DP MM H ₂ O
				SCFM*	PPM		CC/MIN*	LPM*	Kg/M	
 <p>Model 50MT10 Utilizes stainless steel capillary tubes cemented into a stainless steel body. Inlet and outlet connections are VCO type. Differential pressure connections are 1/4" SAE J1926 port, O-ring boss.</p>			50MT10-8			4"				101.6
			50MT10-7			4"				101.6
			50MT10-6			4"				101.6
			50MT10-5			4"				101.6
			50MT10-4			4"				101.6
			50MT10-3			4"				101.6
			50MT10-2			4"				101.6
		50MT10-1			4"				101.6	
 <p>Model 50MT10 All stainless steel unit with fused matrix. Inlet and outlet connections are VCO type. Differential pressure connections are 1/4" SAE J1926 port, O-ring boss.</p>			50MT10-14			8"				203.2
			50MT10-13			8"				203.2
			50MT10-12			8"				203.2
			50MT10-11			8"				203.2
			50MT10-10			8"				203.2
		50MT10-9			8"				203.2	
 <p>50MT20 All stainless steel unit with fused matrix. Inlet and outlet connections are VCO type. Differential pressure connections are 1/4" SAE J1926 port, O-ring boss.</p>			50MT20-1			8"				203.2
			50MT20-1½			8"				203.2
			50MT20-2			8"				203.2

NOTES:

1. The flows and differential pressure rating of production units are subject to a variation of plus or minus 10% from the nominal values listed above.
2. Each LFE unit is calibrated with air to Meriam flow standards which are traceable to the National Bureau of Standards. Meriam calibration flow curves are furnished with each unit.
3. A special service is available for those Meriam LFE units which are governed by quality programs requiring periodic recalibration. The Special Calibration Procedure A-33544 is designed to meet the basic requirements of 10CFR50, ANSI-Z540-I & ML-Q-9858A. Contact Meriam direct for information.
4. The catalog capacities refer to the following base conditions:
 Air, 29.92" Hg Abs., 70° F, 181.87 micropoise.
 Base Reynold's Number: 300 at 8" H₂O, 150 at 4" H₂O.
5. SCFM* - Equivalent air flow at base conditions listed above.
6. All units are offered with optional integral filter on inlet side except those marked (x). Removal or replacement of filter necessitates recalibration.
7. Rated flow pressure and temperature for standard units are 30 psig and 150°F to maintain laminar flow, calibration, linearity and accuracy. For higher pressure and temperature rating contact a Meriam Representative, or Meriam Process Technologies direct.

Installation and Secondary Instrumentation

Install the laminar flow element in the line using hose connectors, flanges, tubing or pipe, as needed for the selected model. Position is immaterial, but flow must be in the direction of the arrow on the element.

Disturbances upstream of the element are to be avoided. Good measurement practices dictate an adequate straight run of pipe up and downstream of the element. In most installations, 10 diameters upstream and 5 diameters downstream are adequate.

Where installation requirements limit the straight runs available, LFEs can be calibrated in piping configurations duplicating the installation configuration. This assures "installed accuracy". For these applications, consult Meriam regarding calibration.

Connections to the differential pressure instrument should be made with equal lengths of 1/4" I.D. hose, tubing, or pipe. All instrument connections must be leak free. The temperature sensor should be installed upstream of the element to give a good indication of the temperature of the flowing gas at the element.

The metered gas must be clean and the use of filters is recommended. Five micron automotive filters are ideal for intake air flow to an engine or other intake applications. For LFEs with direct coupled inlet filters, care must be taken to insure accurate results. Due to asymmetry of filter elements, calibration accuracy of assembly cannot be guaranteed if filter is removed for any reason. If filter is removed or replaced, the assembly should be recalibrated to ensure accurate performance. When inline filters are used, be sure to locate them 10 diameters upstream of the LFE.

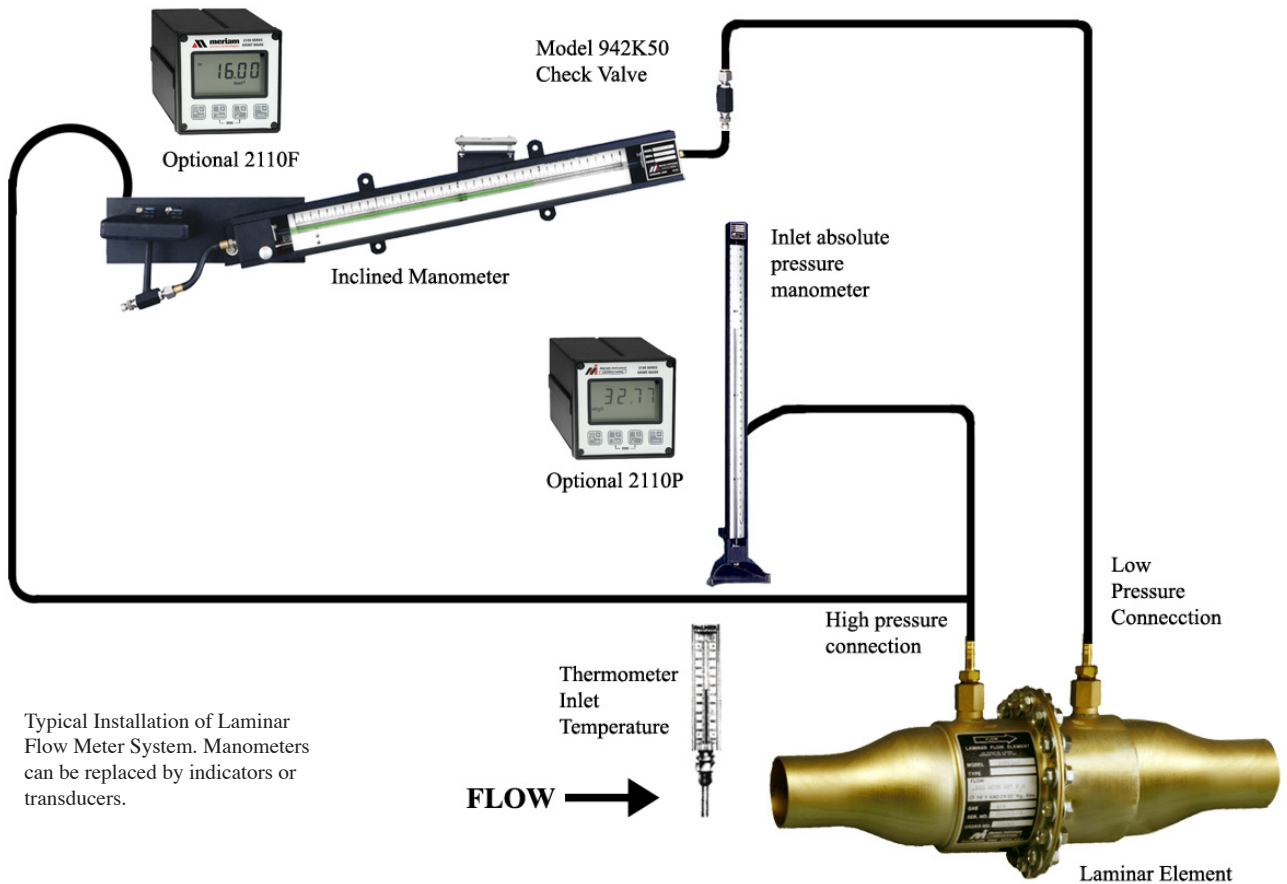

LFE Measurement Systems

With the proper instrumentation, LFEs can measure mass, standard volumetric or actual volumetric flow rates. Three measured flow parameters are required: differential pressure, absolute inlet pressure, and flowing temperature. A fourth parameter, relative humidity, is often measured to correct for its affect on air viscosity and density. For manual measurement systems, the DP is often measured using inclined tube or micro-manometers. These instruments are capable of measuring to 0.01" and 0.001" of water column, respectively.



LFS-3 Flopac System for LFEs

Mechanical gauges and electronic transducers can also be used. The inlet pressure of the LFE is usually measured by a gauge pressure manometer, indicator or electronic transducer. A barometric pressure reading must be made and added to gauge pressure readings to obtain absolute inlet pressure for use in flow calculations. A temperature device is needed to measure flow stream temperature, and a relative humidity device should be used to measure air humidity when the most accurate results are needed. When all parameters are known, the user can manually calculate the flow rate or use calibration curves with pressure, temperature and relative humidity correction curves.

Manual data collection and calculation methods tend to be a low cost solution for LFE measurement, but they can also be cumbersome and prone to error. Human factors such as the correct observation of mechanical indicators, transcription of the data and application of the data in the correct flow equations can all be sources of unwanted error. Automated LFE systems address these problems with speed, a variety of control features, and a host of data processing, archiving and presentation options.

Automated LFE systems measure the needed parameters automatically and then process the data using a central processing unit (CPU). DP and absolute pressure transducers are used to measure the required pressures and convert them to an equivalent analog signal. A thermocouple or RTD measures temperature. For the most demanding applications, relative humidity transducers can be used to correct for its affect on gas density and viscosity. The CPU uses the transducer signals to execute the LFE flow algorithm and make real time corrections for variations in flowing pressure, temperature and humidity. Most automated LFE measurement packages come as plug-and-play systems with wiring and piping complete. The user only needs to make the DP connections to the LFE and to connect the LFE to the flow line. CPU output proportional to corrected flow rate and total flow are available in analog or digital formats. Typical accuracy of such systems (including LFE accuracy) range from $\pm 0.8\%$ to $\pm 2.0\%$ of reading for flow turndown up to 20:1 using a single LFE.

The reliability, accuracy and flexibility of automated systems are real pluses to LFE users. Not only are classic LFE equations and corrections supported, but newer calculation models that provide accurate flow rate when operating at high temperatures and pressures are easily selected and applied. PC based systems with Windows compatible software offer a wide range of set up, processing, documentation, archiving and presentation options. Software that is formatted with all of the coefficients and calculation options, uses digital data collection, and that executes complex equations in user preferred units make difficult flow measurement tasks easier. PLC's and microprocessor controlled flow computers also offer computation speed and a variety of digital and analog outputs for a variety of control and data transfer purposes.



LFS-1 19" Computer Rack System for LFEs

Meriam offers the LFS-1 computer flow system with state-of-the-art flow computer and transducers in a 19" computer rack for plug and play convenience in the flow lab. Use the LFS-1 with any Meriam LFE. Meriam also offers the LFS-3 transducer enclosure with SoftFlow PC software application. The LFS-3 provides DP, P, T and Rh data via an RS-485 output to the users PC. SoftFlow software loads on the user's PC to set up desired units and calculate flow rate.

Flow Calculation Methods

Two methods are available for calculating the flow rate through an LFE. The Classical method provides flow rate calculation to the stated accuracy for inlet pressures from 9.7 PSIA to 44.7 PSIA and flowing temperatures from 30°F to 120°F. The Universal Calibration Curve method is recommended for flowing conditions beyond the Classical method guidelines. Both methods require the measurement of inlet pressure, flow stream temperature and differential pressure across the LFE ports. The measurement of humidity is also recommended when the best possible calculation accuracy is required.

Classical Method: recommended for service from 9.7 PSIA to 44.7 PSIA and 30°F to 120°F

LFEs are normally shipped with calibration curves generated for Classical calculation of flow. The LFE User's Manual (F/N 501:440) provides instructions for determining actual flow volume or standard flow volume from the curve. The curves have a horizontal axis for differential pressure measured across the LFE and a vertical axis for flow rate. See the LFE User's Manual for more details on calculating flow rate from the supplied calibration curve.

Classical equations are shown below for dry gases. These equations can be used to manually calculate flow from LFE measurements or they can be programmed into a PC or PLC for automatic calculation.

$$\text{Actual Volumetric Flow} = [(B \cdot DP) + (C \cdot DP^2)] \cdot \mu_{@70 \text{ deg F}} / \mu_{@ \text{Flowing T}}$$

$$\text{Standard Volumetric Flow} = \text{Actual Volumetric Flow} \cdot (T_{\text{std}} / T_f) \cdot (P_f / P_{\text{std}})$$

Note: If humid air is flowing, humidity correction factors for wet air viscosity and wet air density should be made for optimum accuracy. Consult the LFE User's Manual (F/N 501:440) for more details.

Universal Method: recommended for service beyond the Classical Method suggested limits

The Universal Calibration Curve method is recommended for calculation of flow rate through an LFE in applications having pressures above 44.7 PSIA and / or temperatures above 120°F. This method is not a flow versus differential pressure curve. The x-axis of the Universal Curve is the factor: density times differential pressure divided by viscosity squared $[(\rho \cdot DP) / \mu^2]$. The y-axis is the factor: actual volumetric flow rate times viscosity of the flowing gas divided by differential pressure $[(q \cdot \mu) / DP]$.

- 1) Measure the LFE inlet pressure, flowing gas temperature and differential pressure across the LFE
- 2) Calculate the viscosity and density of the flowing gas at the measured conditions
- 3) Calculate the value of the x-axis: $(\rho \cdot DP) / \mu^2$
- 4) Use $A_0 + A_1[(\rho \cdot DP) / (\mu^2)] + A_2[(\rho \cdot DP) / (\mu^2)]^2$ to calculate the value of the y-axis: $(q \cdot \mu) / DP$
- 5) To determine the Actual Volumetric Flow (q), multiply the y-axis value from #4 by (DP/μ)
- 6) To determine Standard Volumetric Flow (Q), multiply q by $(\rho_f / \rho_{\text{std}})$ where ρ_f is the density of the flowing gas at flowing conditions and ρ_{std} is the density of the flowing gas at standard conditions
- 7) To determine Mass Flow (m), multiply q by ρ_f

Note: All curves and calculations are dependent on the units of each parameter. All temperature and pressure values must be in absolute units (e.g. °K, or °R for temperature, PSIA or mm Hg Abs for pressure). The units for flow rate, density, viscosity and differential pressure are provided on the Universal Calibration Curve provided with the LFE. Be sure the values used in the equations above have the same units as called for by the Universal Curve.

To provide the accurate answers you need in the shortest amount of time...

Please Provide us With the Following Ordering Data:

1. Model number.
2. Flowing gas data;
 - a. Flow rate in desired units.
 - b. Base conditions.
 - i. Pressure
 - ii. Temperature
 - c. Flowing conditions
 - i. Pressure
 - ii. Temperature
 - iii. Viscosity at flowing temperature.
 - d. Differential at maximum flow.
 - e. Specific gravity, if other than air.
 - f. Flowing gas, if other than air.
3. Readout instrument.
4. Description of installation configuration.
5. Line size.
6. Line Material.
7. Accuracy required

Typical Laminar Flow Element DP vs. Flow Curve



KEY

Red line: Straight line for reference
Blue line: Typical LFE calibration curve

Special Calibration Procedure

A special service is available for those Meriam LFE units which are governed by quality programs requiring periodic recalibration. The Special Calibration Procedure #A-33544 is designed to meet the basic requirements of 10CFR50, ANSI-Z540-I & ML-Q-9858A. Contact Meriam direct for information.

ISO 17025 Certified Flow Lab

Meriam maintains an LFE flow lab to ISO 17025 requirements. View our ISO 17025 Certification at www.meriam.com

Meriam Field Representatives in principal cities throughout the country are ready to serve you. Call on them for help when you have flow measurement problems. Or, if you prefer, contact us direct.



a Scott Fetzer company

10920 Madison Ave. Cleveland, OH 44102
216-281-1100 Fax: 216-281-0228
meriam@meriam.com

www.meriam.com