



VF-1200 DMX  
VertiFog CO2 FX  
fog machine

Musikhaus Thomann

Hans-Thomann-Staße 1

96138 Burgebrach

Germany

Telephone: +49 (0) 9546 9223-0

E-mail: [info@thomann.de](mailto:info@thomann.de)

Internet: [www.thomann.de](http://www.thomann.de)

25.06.2015, ID: 362289

# Table of contents

<b>1</b>	<b>General information</b> .....	<b>5</b>
	1.1 Further information.....	6
	1.2 Notational conventions.....	7
	1.3 Symbols and signal words.....	7
<b>2</b>	<b>Safety instructions</b> .....	<b>10</b>
<b>3</b>	<b>Features</b> .....	<b>17</b>
<b>4</b>	<b>Installation</b> .....	<b>18</b>
<b>5</b>	<b>Starting up</b> .....	<b>19</b>
<b>6</b>	<b>Connections and operating elements</b> .....	<b>21</b>
<b>7</b>	<b>Operating</b> .....	<b>28</b>
	7.1 Operating mode 'DMX'.....	30
<b>8</b>	<b>Technical specifications</b> .....	<b>32</b>
<b>9</b>	<b>Troubleshooting</b> .....	<b>33</b>
<b>10</b>	<b>Cleaning</b> .....	<b>35</b>

**11 Protecting the environment..... 37**

# 1 General information

This manual contains important instructions for the safe operation of the unit. Read and follow the safety instructions and all other instructions. Keep the manual for future reference. Make sure that it is available to all those using the device. If you sell the unit please make sure that the buyer also receives this manual.

Our products are subject to a process of continuous development. Thus, they are subject to change.

## 1.1 Further information

On our website ([www.thomann.de](http://www.thomann.de)) you will find lots of further information and details on the following points:

Download	This manual is also available as PDF file for you to download.
Keyword search	Use the search function in the electronic version to find the topics of interest for you quickly.
Online guides	Our online guides provide detailed information on technical basics and terms.
Personal consultation	For personal consultation please contact our technical hotline.
Service	If you have any problems with the device the customer service will gladly assist you.

## 1.2 Notational conventions

This manual uses the following notational conventions:

### Letterings

The letterings for connectors and controls are marked by square brackets and italics.





**Examples:** *[VOLUME]* control, *[Mono]* button.

## 1.3 Symbols and signal words

In this section you will find an overview of the meaning of symbols and signal words that are used in this manual.

Signal word	Meaning
<b>DANGER!</b>	This combination of symbol and signal word indicates an immediate dangerous situation that will result in death or serious injury if it is not avoided.
<b>WARNING!</b>	This combination of symbol and signal word indicates a possible dangerous situation that can result in death or serious injury if it is not avoided.
<b>CAUTION!</b>	This combination of symbol and signal word indicates a possible dangerous situation that can result in minor injury if it is not avoided.
<b>NOTICE!</b>	This combination of symbol and signal word indicates a possible dangerous situation that can result in material and environmental damage if it is not avoided.
Warning signs	Type of danger
	Warning – high-voltage.



Warning signs	Type of danger
	Warning – flammable substances.
	Warning – hot surface.
	Warning – harmful or irritating substances.
	Warning – danger zone.

## 2 Safety instructions

### Intended use

This device is intended to be used to produce artificial fog by vaporising fog fluid. Use the device only as described in this user manual. Any other use or use under other operating conditions is considered to be improper and may result in personal injury or property damage. No liability will be assumed for damages resulting from improper use.

This device may be used only by persons with sufficient physical, sensorial, and intellectual abilities and having corresponding knowledge and experience. Other persons may use this device only if they are supervised or instructed by a person who is responsible for their safety.

### Safety



#### **DANGER!**

#### **Danger for children**

Ensure that plastic bags, packaging, etc. are disposed of properly and are not within reach of babies and young children. Choking hazard!

Ensure that children do not detach any small parts (e.g. knobs or the like) from the unit. They could swallow the pieces and choke!

Never let children unattended use electrical devices.



**DANGER!**

**Electric shock caused by high voltages inside**

Within the device there are areas where high voltages may be present. Never remove any covers.

There are no user-serviceable parts inside.

Do not use the device if covers, protectors or optical components are missing or damaged.



**DANGER!**

**Electric shock caused by short-circuit**

Always use proper ready-made insulated mains cabling (power cord) with a protective contact plug. Do not modify the mains cable or the plug. Failure to do so could result in electric shock/death or fire. If in doubt, seek advice from a registered electrician.



### **WARNING!**

#### **Risk of burns from flammable liquids**

The use of flammable liquids in this device may cause severe burns and damage to property.

Always use approved fog fluids. Never fill flammable liquids into the tank of the device.



### **WARNING!**

#### **Risk of burns**

The generated fog at the fog nozzle is hot and can cause burns. Occasionally hot fluid drops may escape from the nozzle.

The distance of persons and objects to the fog nozzle must be at least fifty centimetre (1.6 feet).

Do not touch the fog nozzle during and shortly after operation. It becomes very hot and may cause burns even several hours after switching off the device.



**WARNING!**

**Risk of slipping caused by condensation**

Fog machines can produce condensation. Do not direct the fog to floors. Floors and surfaces can become slippery by condensed fog.

Check at regular intervals whether it is possible to walk on the floors without a slipping hazard, and, if necessary, remove the condensation.



**WARNING!**

**Health hazard caused by fog fluid handling**

Fog fluid does contain glycols complying with the regulations for foodstuffs. However, it may be harmful if swallowed.

Do not induce vomiting. Seek medical advice immediately. Keep fog fluid in a safe place. If the fog fluid comes into contact with eyes rinse thoroughly with water.



**CAUTION!**

**Possible respiratory problems**

The device can be operated safely only with the approved fog fluid. The use of other fluids can release toxic gases. Claims for damages caused by the use of non-approved fluids shall be excluded.

Do not create fog in closed or poorly ventilated areas.

Do not expose persons with health problems (such as allergic respiratory conditions, asthma) to artificial fog.



**NOTICE!**

**Risk of fire**

Do not cover the device nor any ventilation slots. Do not place the device near any direct heat source. Keep the device away from naked flames.



**NOTICE!**

**Operating conditions**

This device has been designed for indoor use only. To prevent damage, never expose the device to any liquid or moisture. Avoid direct sunlight, heavy dirt, and strong vibrations.



**NOTICE!**

**Power supply**

Before connecting the device, ensure that the input voltage (AC outlet) matches the voltage rating of the device and that the AC outlet is protected by a residual current circuit breaker. Failure to do so could result in damage to the device and possibly injure the user.

Unplug the device before electrical storms occur and when it is unused for long periods of time to reduce the risk of electric shock or fire.



### **NOTICE!**

#### **Possible staining**

The plasticiser contained in the rubber feet of this product may possibly react with the coating of your parquet, linoleum, laminate or PVC floor and after some time cause permanent dark stains.

In case of doubt, do not put the rubber feet directly on the floor, but use felt-pad floor protectors or a carpet.



### 3 Features

Professional vertical fog machine for producing spectacular fog effects in clubs, bars, discotheques and on stages.

Special features of the device:

- Control via DMX-512 (one channel) or the multi-function control panel
- Adjustable fog output volume and intervals
- Suitable for mobile use
- Specially developed pump system for fog output up to five metres

## 4 Installation

Unpack and carefully check that there is no transportation damage before using the unit. Keep the equipment packaging. To fully protect the device against vibration, dust and moisture during transportation or storage use the original packaging or your own packaging material suitable for transport or storage, respectively.

The device is designed for installation on the floor or on a flat surface and may never be positioned more inclined than 15° in operation.

The device requires 20 cm clearance at the sides and above.



### **NOTICE!**

#### **Possible staining**

The plasticiser contained in the rubber feet of this product may possibly react with the coating of your parquet, linoleum, laminate or PVC floor and after some time cause permanent dark stains.

In case of doubt, do not put the rubber feet directly on the floor, but use felt-pad floor protectors or a carpet.

## 5 Starting up

Establish all connections as long as the unit is switched off. Use the shortest possible high-quality cables for all connections.



### **NOTICE!**

#### **Possible data transmission errors**

For error-free operation make use of dedicated DMX cables and do not use ordinary microphone cables.

Never connect the DMX input or output to audio devices such as mixers or amplifiers.

### Connections in DMX mode

Connect the DMX input of the device to the DMX output of a DMX controller or another DMX device. Connect the output of the first DMX device to the input of the second one, and so on to form a daisy chain. Always ensure that the output of the last DMX device in the daisy chain is terminated with a resistor ( $110\ \Omega$ ,  $\frac{1}{4}\text{ W}$ ).

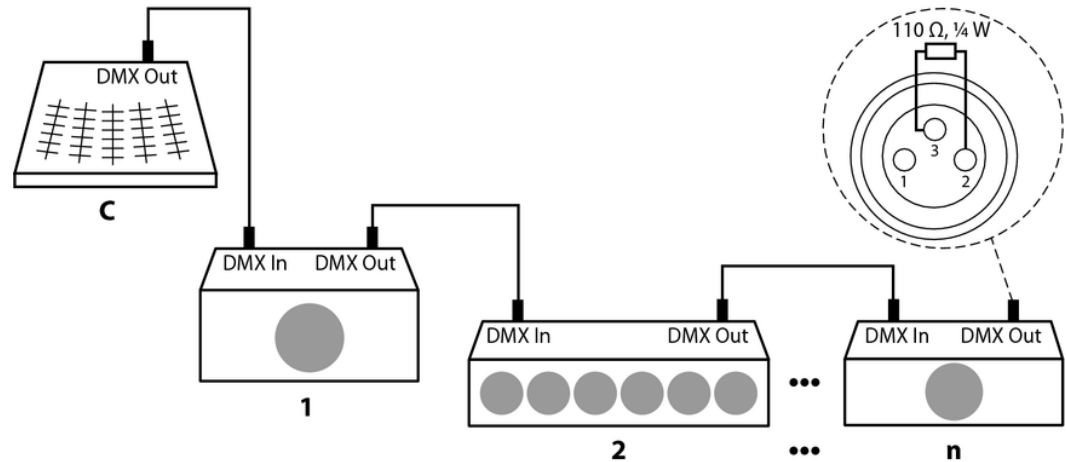

## 6 Connections and operating elements

Top view

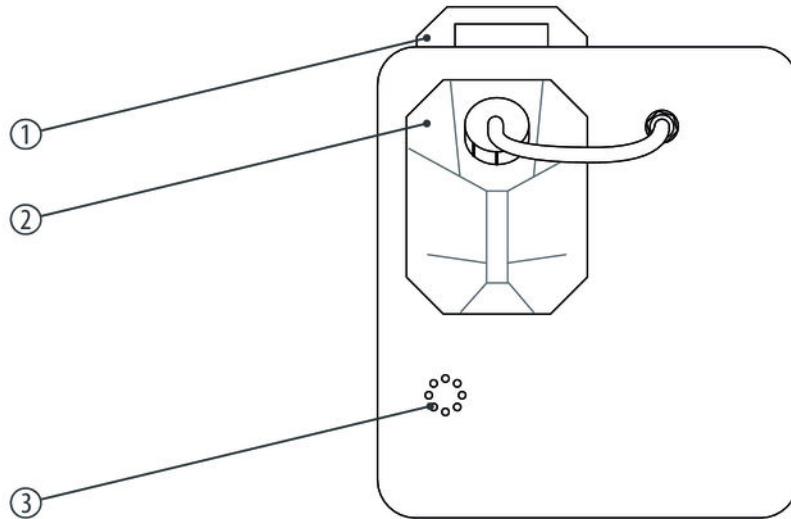

VF-1200 DMX VertiFog CO2 FX

- |   |                                     |
|---|-------------------------------------|
| 1 | Carrying handle.                    |
| 2 | Fog fluid container with screw-cap. |
| 3 | Fog nozzle.                         |

Connections

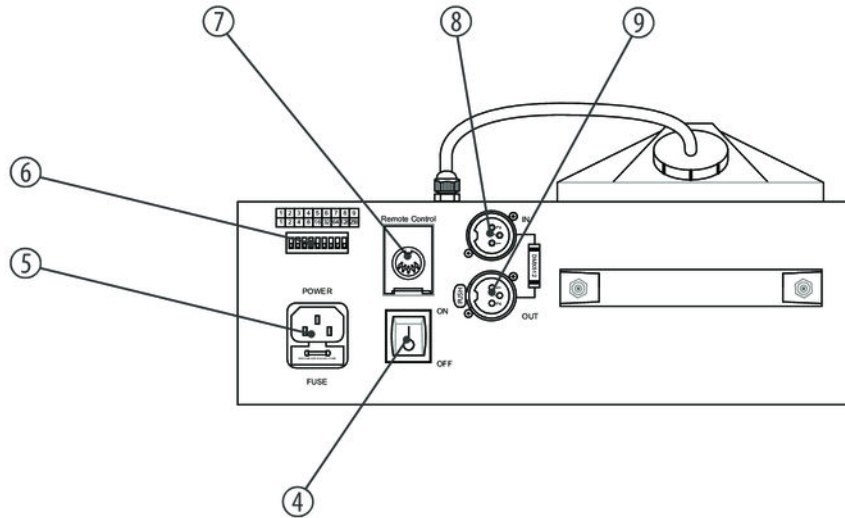

VF-1200 DMX VertiFog CO2 FX

4	<i>[ON   OFF]</i> Main switch to turn the device on and off.
5	<i>[POWER   FUSE]</i> IEC chassis plug with fuse holder for the power supply.
6	DIP switch for setting the DMX address.
7	<i>[Remote Control]</i> Five-pin connector for the multi-function control panel.
8	<i>[IN]</i> DMX input.
9	<i>[OUT]</i> DMX output.



### Multi-function control panel

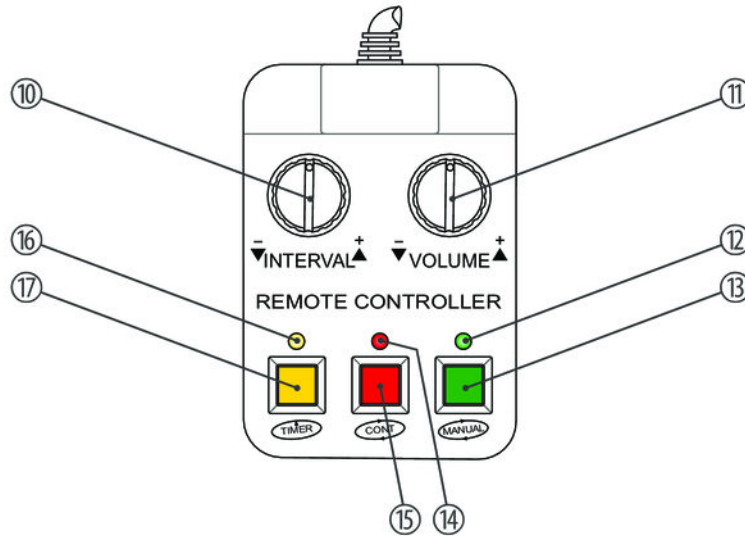

VF-1200 DMX VertiFog CO2 FX

10	<i>[INTERVAL]</i> With this control you can set the output duration per fog blast in a range between 5 and 150 seconds.
11	<i>[VOLUME]</i> With this control you can adjust the amount of fog to be produced by the device with each blast (between 0 % and 100 %).
12	The green LED indicates that the unit has reached the operating temperature necessary to produce fog.
13	<i>[MANUAL]</i> Push this button for maximum fog output regardless of other settings.
14	The red LED indicates that continuous operation is turned on.
15	<i>[CONT]</i> Press this pushbutton to turn continuous operation on or off. In this mode, the fog volume you have set with the <i>[VOLUME]</i> control is continuously emitted until the next reheating.

16 The yellow LED indicates that the Timer function is turned on.

17 *[TIMER]*

Press this pushbutton to let the device eject the fog volume set with the *[VOLUME]* control for the time set with the *[INTERVAL]* control.

## 7 Operating

### Filling the unit



#### **NOTICE!**

#### **Possible damages caused by unsuitable fog fluid**

Fog liquids not approved by the manufacturer may permanently damage the unit.

Only use the fog fluids listed on [www.thomann.de](http://www.thomann.de) and follow their instructions for use.

First, make sure the unit is switched off.

Open the screw-cap of the liquid container and fill in the fog fluid. Make sure that no fluid is spilled or gets into the device. The easiest way is using a funnel. The capacity of the tank is 2.5 litres.

Screw the cap firmly back on.

While the device is not DMX-controlled, connect the included multi-function control panel to the five-pin connector on the device.

## Turning the unit on



### **NOTICE!**

#### **Fire hazard**

Do not operate the machine unattended.

Connect the device to the power grid and turn it on with the main switch.

As soon as the required operating temperature is reached, the green LED on the control panel up.

When operating, always ensure that there is sufficient fog fluid in the liquid container to avoid no-load running.

## Turning the unit off

Turn off the power using the main switch.

Disconnect the supplied multi-function control panel from the five-pin connector on the device.

Transport the device only when it is completely cooled down. To avoid leaking fog fluid during transport, you should transport the device only with empty fluid container.

## 7.1 Operating mode 'DMX'

### Setting the DMX address

Use the DIP switches of the device to set the desired DMX address between 1 and 512 (see the following figure).

DMX Address Set

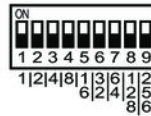

DMX Add 001



DMX Add 002

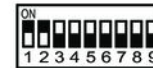

DMX Add 003



DMX Add 004



DMX Add 005

.....



DMX Add 512

**DMX channel assignment**

<b>Channel</b>	<b>Value</b>	<b>Function</b>
1	0 ... 255	No fog output to maximum fog output

## 8 Technical specifications

Heater power	1,200 W
Power consumption	max. 1,250 W
Fog output	approx. 150 m <sup>3</sup> /min
Blast distance	4 ... 5 m
Fluid consumption	approx. 80 ml / min
Fluid container capacity	2.5 l
Warm-up time	approx. 5 min
Operating supply voltage	AC 230 V ~, 50 Hz
Fuse	5 mm × 20 mm, 8 A, 250 V, fast-acting
Dimensions (W × H × D)	305 mm × 170 mm × 390 mm
Weight	6.6 kg



## 9 Troubleshooting

In the following we list a few common problems that may occur during operation. We give you some suggestions for easy troubleshooting:

Symptom	Remedy
The unit does not work	Check the mains connection and the main fuse.
No response to the DMX controller	1. Check the DMX connectors and cables for proper connection.
	2. Check the address settings and the DMX polarity.
	3. Try using another DMX controller.
	4. Check to see if the DMX cables run near or alongside to high voltage cables that may cause damage or interference to DMX interface circuits.
No fog output	1. Check the fluid level in the fog container.
	2. Switch the device off and check the hose that leads into the fluid container for flow.

If the procedures recommended above do not succeed, please contact our Service Center. You can find the contact information at [www.thomann.de](http://www.thomann.de).

## 10 Cleaning



### NOTICE!

#### Possible damages caused by unsuitable cleaning agents

Cleaners not approved by the manufacturer may permanently damage the unit.

Only use the fog machine cleaners listed on [www.thomann.de](http://www.thomann.de) and follow their instructions for use.

Clean the appliance after every 30 operating hours, or if it was not in use for a longer period of time.

### Procedure

1. ➤ Make sure that the device is turned off, disconnected from the mains and completely cooled down.
2. ➤ Place the unit in a well ventilated place.
3. ➤ Take the suction hose out of the fluid container of the fog machine and put it into the bottle with the cleaning fluid.
4. ➤ Connect the device to the mains and turn it on with the main switch.
5. ➤ Wait until the required operating temperature has been reached.

- 6.** ▶ Switch the unit to continuous operation and release fog for about 20 seconds.
- 7.** ▶ Put the suction hose back into the fluid container of the fog machine and release fog for another 20 seconds. This rinses the pipes.
  - ⇒ The cleaning is completed.

## 11 Protecting the environment

### Disposal of the packaging material



For the transport and protective packaging, environmentally friendly materials have been chosen that can be supplied to normal recycling.

Ensure that plastic bags, packaging, etc. are properly disposed of.

Do not just dispose of these materials with your normal household waste, but make sure that they are collected for recycling. Please follow the notes and markings on the packaging.

### Disposal of your old device



This product is subject to the European Waste Electrical and Electronic Equipment Directive (WEEE). Do not dispose with your normal household waste.

Dispose of this device through an approved waste disposal firm or through your local waste facility. When discarding the device, comply with the rules and regulations that apply in your country. If in doubt, consult your local waste disposal facility.





Musikhaus Thomann · Hans-Thomann-Straße 1 · 96138 Burgebrach · Germany · [www.thomann.de](http://www.thomann.de)