

**WIND**

**QUICK GUIDE**



## WELCOME ABOARD YOUR VEHICLE

### Note

Congratulations on your choice and thank you for your purchase.

Your new vehicle was designed by the RENAULT design team to provide you with a versatile model offering a unique style.

Enjoy the exceptional open-air driving experience afforded by your new vehicle and learn about its main features in this document.

**RENAULT** wishes you happy driving.

This document does not replace the driver's handbook.

Please read the complete driver's handbook for more detailed information on your vehicle's equipment.

The reference guide covers all existing equipment (both standard and optional) for all models of this vehicle. Whether the equipment is fitted to the vehicle depends on the version, the options selected and the country where the vehicle is sold.

**Detailed information regarding your vehicle's use, maintenance and warranty, as well as videos and simulators are all only a click away in the e-Guide for your new vehicle, accessible from the website [www.e-guide.renault.com](http://www.e-guide.renault.com).**

Translated from French. Copying or translating, in part or in full, is forbidden unless prior written permission has been obtained from RENAULT, 92 100 Billancourt 2009.



<b>Front and engine compartment</b>	<b>3</b>
<b>Passenger side</b>	<b>4</b>
<b>Rear of the vehicle</b>	<b>5</b>
<b>Rotating hard roof</b>	<b>6</b>
<b>Accessing the vehicle</b>	<b>7</b>
<b>Starting/Stopping the engine</b>	<b>8</b>
<b>Driving position</b>	<b>9</b>
<b>Dashboard</b>	<b>10</b>
<b>Instrument panel</b>	<b>11</b>
<b>Lighting/Wipers</b>	<b>12</b>
<b>Cruise control/Speed limiter</b>	<b>13</b>
<b>Multimedia systems</b>	<b>14</b>
<b>Heating and air conditioning system</b>	<b>17</b>
<b>Gadgets</b>	<b>18</b>
<b>eco2</b>	<b>19</b>

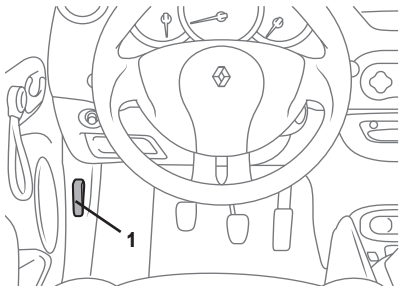

### Opening the bonnet

To open, pull unlocking handle **1** and push the bonnet catch tab to the left. Lift the bonnet and secure it using the stay.

### Closing the bonnet

Check that nothing has been left in the engine compartment. To close the bonnet, replace the stay in its mounting, lower the bonnet to approximately 20 cm above the closed position and release it. It will latch automatically under its own weight. Check that it is locked.

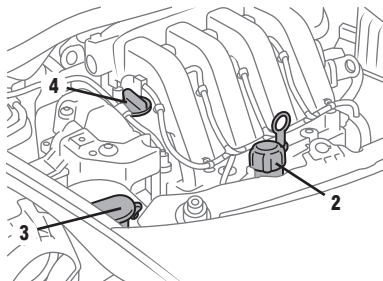

### Coolant level

The level indicated on tank **2** should be between the "MINI" and "MAXI" markings. When this level must be topped up, always do so with the engine cold, switched off and with the vehicle on level ground.

### Screen washer fluid level

With the engine switched off, top up the fluid in reservoir **3** if necessary.

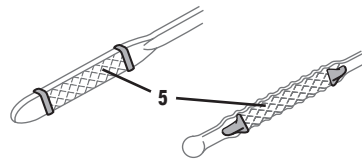

### Engine oil level

To check the oil level, use dipstick **5**. The level indicated on dipstick **5** should be between the MINI and MAXI marks. If the oil level is at minimum, unscrew filler cap **4** to top up the oil. You must observe the service intervals and the oil grades recommended for your engine. Refer to the Maintenance Service document for your vehicle, and to Section 4 of the vehicle handbook for the precautions to take when filling with oil.

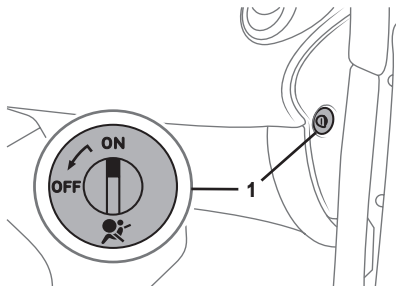

### Deactivating the front passenger air bag

If you wish to fit a rear-facing child seat on the front passenger seat, you must deactivate the air bag: with the vehicle stationary, push and turn switch **1** to **OFF**.

With the ignition on, warning light **2**, , lights up orange on the instrument panel.

Refer to the driver's handbook for specific information on child safety.

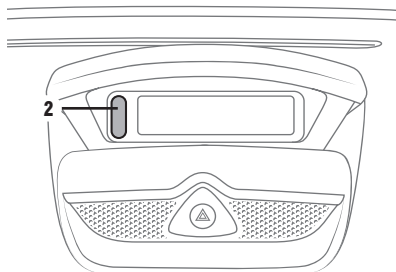

### Activation of the front passenger air bag

You should reactivate the air bag as soon as you remove the child seat from the front passenger seat to ensure the protection of the front passenger in the event of an impact.

To reactivate the air bag: when the vehicle is stationary, push and turn lock **1** to the **ON** position. With the ignition on, it is essential to check that

warning light **2**  on the instrument panel is off.

Immediately reposition the lock to **ON** as soon as you stop using the child seat.

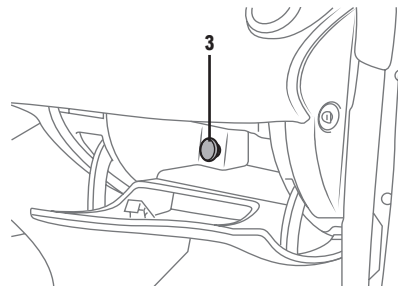

### Accessories socket 3

It is located in the glove box.

It is designed for connecting accessories approved by RENAULT's Technical Department with a maximum power rating of 120 Watts (12 V).

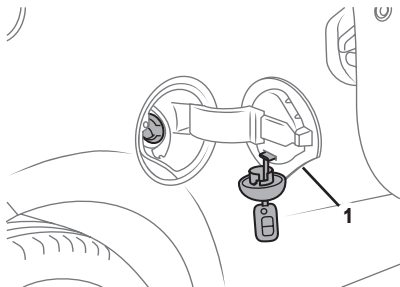

## Fuel tank

Your vehicle is fitted with a flap and a cap.

- To open the flap, place your finger in recess **1** and pull the flap;
- remove the cap;
- when driving, when the low fuel level warning light  comes on, fill the tank as soon as possible.
- After the warning light comes on, you have approximately **30 miles (50 km)** left, driving at moderate speed.

The fuel tank capacity is approximately 40 litres.

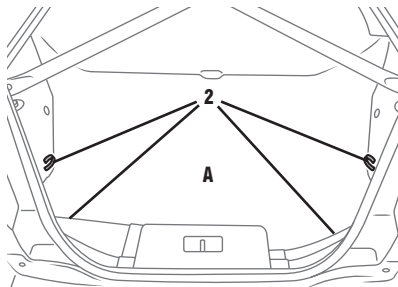

## Tyre pressure kit/ emergency spare wheel

Depending on the vehicle, in the event of a puncture, there is an emergency spare wheel or a tyre inflation kit. Depending on the vehicle, you may have a storage compartment. To access it, lift luggage compartment carpet **A**.

Refer to Section 5 of your driver's handbook.

## Anchorage points

Hooks **2** located on either side of the luggage compartment allow the load to be secured.

## Luggage compartment volume

When the roof is folded back in its compartment, you still have the entire volume of the luggage compartment.

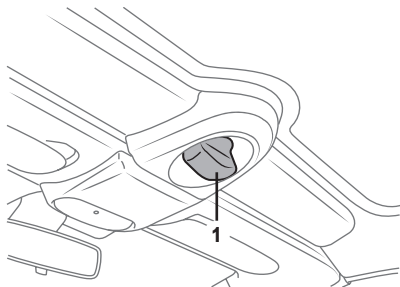

## Opening the rotating hard roof

With the engine running and the handbrake engaged.

Unlock the roof by pulling and turning control **1** clockwise.

Do not lift the roof.

Lower control **2** (movement **B**) until the message "roof open" appears on the instrument panel and a beep sounds. The side windows and roof cover open.

The roof folds into its housing and the roof cover closes.

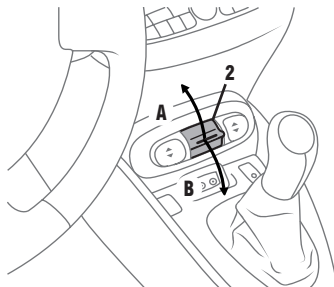

## Closing the rotating hard roof

With the engine running and the handbrake engaged, raise control **2** (movement **A**) until the message "lock handle" appears on the instrument panel and a beep sounds.

The side windows and roof cover open.

The roof and its cover close.

Lock the roof by turning control **1** anticlockwise.

**Do not move handle 1 when driving.**

## Locking/unlocking the vehicle

### RENAULT REMOTE CONTROL KEY A OR B

Press:



to unlock;



to lock.

In all situations:

- Two flashes of the direction indicator lights confirm vehicle locking;
- One flash of the direction indicator lights confirms vehicle unlocking.

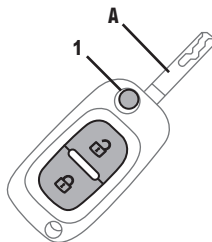

#### SPECIAL FEATURES OF KEY A

To release key **A** from its housing, press button **1**, it will come out automatically.

To reinsert it in its housing, press button **1** and move key **A** until it is locked away.

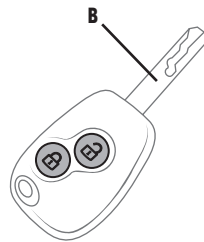

#### SPECIAL FEATURES

– Never leave a key in the vehicle;

–  depending on the vehicle, pressing this button twice in succession prevents the vehicle from being opened, even from the inside.



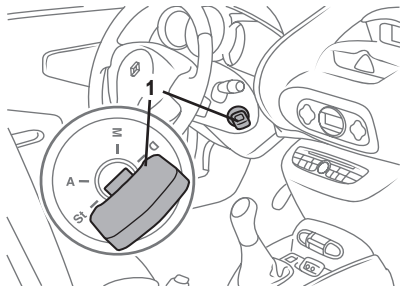

## Starting the engine

With the key in the ignition switch **1**, turn it fully on. Once the engine has started, release it.

## Stopping the engine

With the engine idling, turn the key towards you.

## Accessing functions

Turn the key through two positions to be able to use certain functions (radio, wipers...)

Depending on the case, these functions will switch off at the latest when the vehicle is locked.



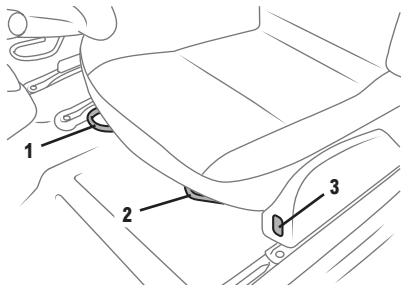

## Manual seat adjustment

### MOVING THE SEAT FORWARDS OR BACKWARDS

Lift handle **1** to release. Release the handle once the seat is in the correct position and ensure that the seat is fully locked into position.

### RAISING OR LOWERING THE SEAT

Depending on the vehicle, lift handle **2**.

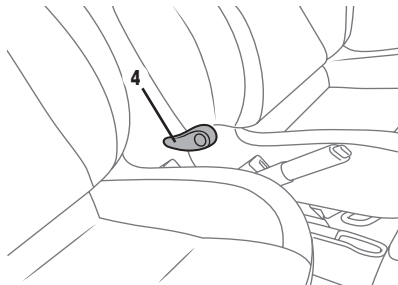

### TILTING THE SEATBACK

Move the lever **4** and tilt the seatback to the required position.

### Heated seats

With the ignition on, press switch **3**.

The system, which has a thermostat, decides whether or not the heating is needed.

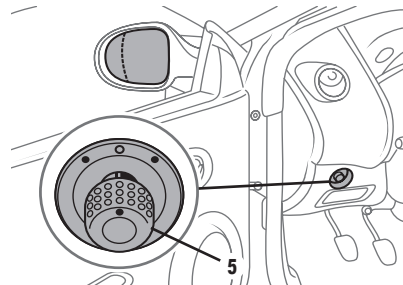

## Door mirrors with electrical adjustment:

### REAR VIEW MIRROR WITH BUTTON 5

Select the rear view mirror using button **5**, then adjust it to the required position.

### HEATED DOOR MIRRORS

Depending on the vehicle, the door mirrors may be heated. To activate this function, refer to the information on the "Heating and air conditioning system" in Section 3 of your driver's handbook.

The equipment fitted, described opposite, **DEPENDS ON THE VEHICLE VERSION AND THE COUNTRY.**

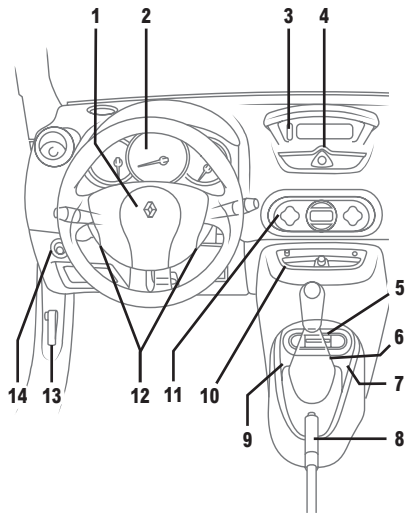

1 Location of the driver's air bag.

2 Instrument panel.

3 Front seat belt reminder warning lights and passenger air bag activation/deactivation status indicator lights:



driver or front passenger seat belt not buckled;



passenger air bag in the **OFF** position;

4 Hazard warning lights.

5 Electric window controls, rotating hard roof opening/closing control.

6 Sockets for audio connection

These give you the option to connect a portable audio player, an MP3 player, a USB key, etc. to your audio system.

7 Central door locking/unlocking controls.

8 Manual parking brake control.

9 Cruise control/speed limiter main on/off switch.

10 Location for radio.

11 Heating/air conditioning controls.

12 Cruise control/speed limiter control.

13 Bonnet release control.

14 Controls for adjusting the electric door mirrors.



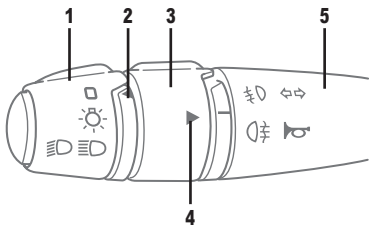

**Lighting control 5**

Turn ring 1 until the symbol is opposite mark 2.



switches on the side lights;



switches on the dipped beam headlights;

**Main beam headlights:** with ring 1 in position



, pull stalk 5 towards you;

**Flash headlights:** pull stalk 5 towards you.

**Note:** depending on the vehicle, the dipped beam headlights come on automatically. Refer to the driver's handbook to activate/deactivate the automatic mode.

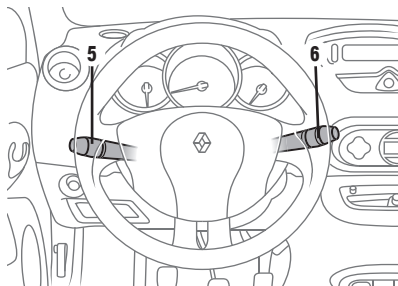

Turn ring 3 until the symbol is opposite mark 4.



switches on the front fog lights;



switches on the front and rear fog lights.

To switch off, repeat the operation.

**Lights-on warning buzzer:** when the front doors are opened, a buzzer sounds to warn you that the lights are on when the ignition is switched off (to prevent the battery from discharging).

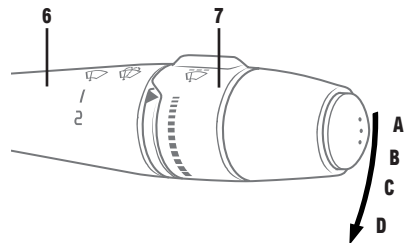

**Wiper control 6**

With the ignition on, position stalk 6 for:

- A:** Park position
- B:** Intermittent or automatic wiping
- C:** normal wiping speed
- D:** fast wiping speed

Windscreen washer: pull stalk 6 towards you.

**Note:** depending on the vehicle, adjust the wiping speed and the sensitivity of automatic wiping activation by turning ring 7.

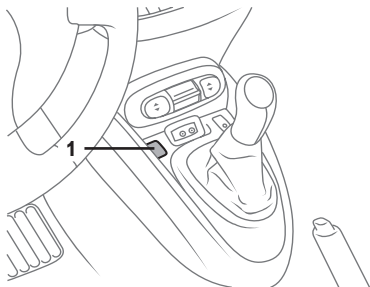

### Cruise control/speed limiter



The cruise control is a function which helps you to keep your driving speed at a constant value.



The speed limiter function helps you stay within the driving speed limit.

If fitted to the vehicle, select the cruise control or speed limiter by moving switch **1**.

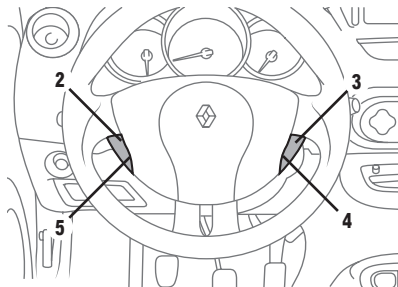

### Cruise control/speed limiter controls

- Activation, storage and increase switch for the programmed speed: button **2** (+);
- Activation, storage and decrease switch for the programmed speed: button **5** (-);
- Programmed speed storage function standby: button **3** (O);
- Activation, storage and recall switch for limit/cruising speed or programmed speed: button **4** (R).

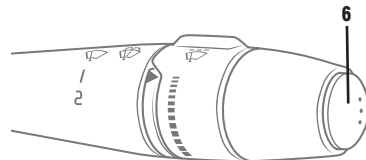

### Dashboard and instrument panel brightness management

To access this menu, with the vehicle stopped:

- press and hold **6**, to enter the “brightness” menu;
- set the brightness by successively pressing **6**;
- confirm by pressing and holding **6**.

To use the cruise control/speed limiter, refer to Section 2 of your driver's handbook.

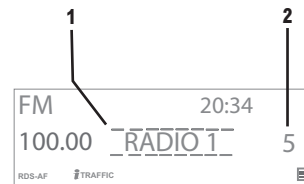
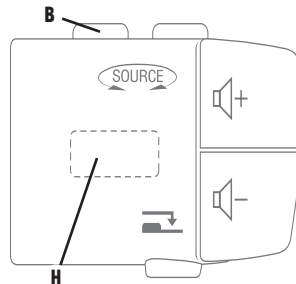
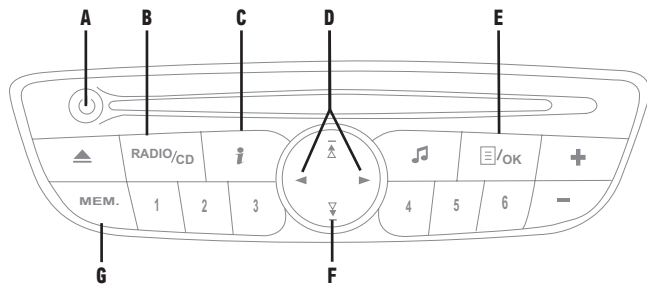

## LISTENING TO THE RADIO, A CD (AUDIO AND MP3) OR A PLAYER

Press **A** to switch the system on or off. Select the desired source by pressing one of the keys **B** once or several times.

If you wish to listen to an AUXILIARY source, connect your portable audio player to the desired socket (refer to the "Dashboard" section).

## FM RADIO SOURCE

To update the list of stations, press **C** then **F**, or turn **H** to select the option "Update FM List", and confirm by pressing **E** or **H**.

To select a radio station from an alphabetical list, press **D** to go to station name field **1**, then turn **H** or press **F** several times to scroll through the list of radio stations.

To save a station to one of the keys numbered 1 to 6, select a radio station and press one of keys 1 to 6 until you hear a beep.

To recall a stored station, press the corresponding button.

To save up to 12 FM stations, select a radio station, press **G** and use **F** or turn **H** to select a location from 1 to 12. Confirm by pressing **E** or **H**.

To recall a stored station, press the buttons **D** to move horizontally to the station number **2** by pressing **D**, then scroll through the radio stations using **F** or **H**.

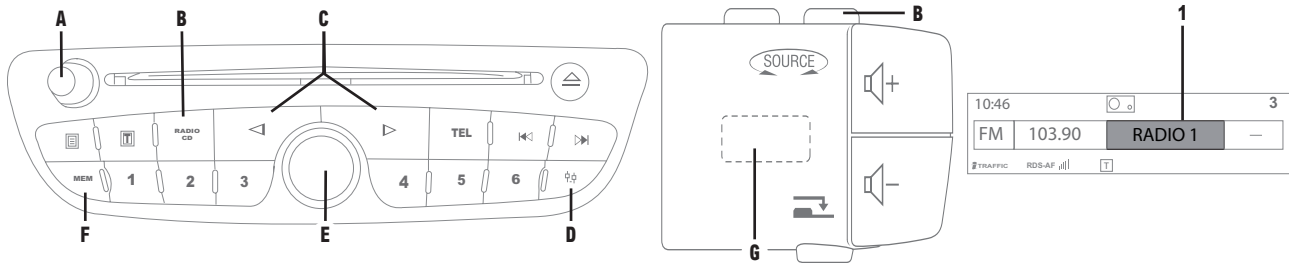

To switch the system on or off, press **A**. Adjust the volume by turning button **A**.

### LISTENING TO THE RADIO, A CD OR AN AUDIO PLAYER

Select the desired source by pressing one of keys **B** once or several times.  
If you wish to listen to an **AUXILIARY** source, connect your portable audio player to the desired socket (refer to the "Dashboard" section).

### FM RADIO SOURCE

To select a radio station from an alphabetical list, press **C** to go to the station name field **1**, then turn **E** or **G** to scroll through the list of radio stations.

To update the list: press **D**, then turn **E** or **G** to select the "Audio settings" field then "Radio functions" and "Update FM list"; confirm by pressing **E** or **G**.

To store a station from 1 to 6: select a radio station then press one of the buttons 1 to 6 until a beep sounds.

To recall a stored station, press the corresponding button.  
Button **F** is used to store up to 12 stations (refer to the previous page).

### Pairing your Bluetooth® device

In order to use your hands-free device (telephone, portable audio player), you must pair it (button **D**) when using it for the first time. After this, it will automatically be recognised and connected to the hands-free system once the vehicle ignition is switched on. Refer to the section entitled "Bluetooth® connection" in the driver's handbook.



In order to use a Bluetooth® device, either a telephone or portable audio player (depending on the vehicle), from your multimedia system, please follow the instructions below.

### Pairing a Bluetooth® device

#### PRINCIPLE

Pairing will enable the multimedia system to recognise and store your Bluetooth® device. This is the first step to carry out in order to use your telephone or portable audio player.

**Note:** you can pair several devices to your multimedia system, but only one device can be used at a time (a single telephone or a single portable audio player).

Contact your RENAULT dealer for a list of available devices.

#### PAIRING STEPS

Pairing is carried out directly on your device (refer to its user instructions):

- check that your multimedia system and your Bluetooth® device are on;
- activate the Bluetooth® connection on your device;
- in the multimedia system settings menu, select the field which allows you to store or pair a Bluetooth® device;
- launch a search for Bluetooth® equipment from your device;
- select “My-Radiosat” or “MY-CAR” from the list of devices found;
- enter the pairing code using your device’s keypad (it will appear on the multimedia system screen, otherwise refer to the user instructions for the system).

The device is paired.

### Connecting a Bluetooth® device

Your Bluetooth® device must be connected to the multimedia system for all its functions to be accessible.

To connect your device, select it from the list of devices stored in the multimedia system.

The multimedia system may also automatically recognise your device once it is switched on.

### Using a Bluetooth® device

With your Bluetooth® device connected, you can use some functions directly via the controls on your audio system.

You can also:

- for a portable audio system: select a music track or an album...;
- for a telephone: display the telephone address book, call a contact from the telephone address book, update the telephone address book...

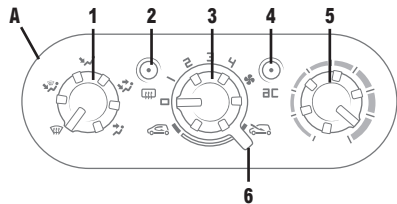

### Manual air conditioning/ heating A

- Distribute the air: turn control **1** to select one of the 5 positions;
- activate de-icing of the rear screen (and, depending on the vehicle, the door mirrors): press switch **2**;
- adjust the ventilation speed: turn control **3**;
- activate the air conditioning (depending on the vehicle): press button **4**;
- select the temperature: turn control **5**;
- recirculate the air: turn control **6**.

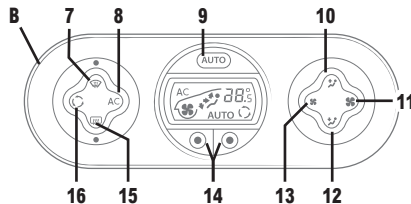

### Automatic climate control B

#### ACTIVATING AUTOMATIC MODE

- Select the required temperature using buttons **14**;
- press button **9** for automatic mode to control the system.

**Note:** pressing button **8** deactivates the air conditioning. The AC OFF indicator light comes on. When button **8** is pressed again, the air conditioning is automatically controlled by the system.

Note: pressing any of the buttons (except **14**) will deactivate the automatic mode.

#### AIR RECIRCULATION

Button **16** can be used to recirculate the passenger compartment air.

#### ADJUSTING THE AIR DISTRIBUTION

Press button **10** or **12** to select the desired position.

#### ADJUSTING THE VENTILATION SPEED

Press button **11** or **13** to increase or decrease the air flow.

#### DEMISTING/DE-ICING

Press button **7** to activate demisting and de-icing of the windscreen, side windows, rear screen and/or door mirrors.

Press button **15** to activate demisting/de-icing of the rear screen and/or door mirrors.

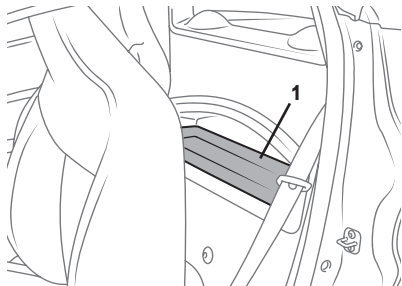

### **Rear storage compartment 1**

To access the storage compartment, move the seat forwards and tilt the seatback forwards.

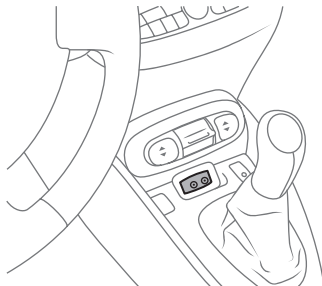

### **Auxiliary sockets**

Depending on the vehicle, you have an auxiliary input: RCA socket or audio multi-connection unit with USB and Jack sockets. This allows you to connect an external audio source (portable audio player, MP3 player, USB key, etc) and listen to your portable audio player directly through the vehicle's speakers.

Refer to the user manual for your audio system or equipment to find out how to connect your audio device.



When using your vehicle, adopt an economical driving style. These driving guidelines will help you to consume less fuel.

Six pieces of everyday practical advice for fuel savings of 10% to 20%.

### 1 ADAPT THE GEAR CHANGES

- Change up a gear from 2000 rpm in Diesel vehicles and 2400 rpm in Petrol vehicles;
- change down a gear from 1000 rpm;
- at a stable speed or for gentle acceleration, use the top gear.

### 2 DRIVE FLEXIBLY

- Anticipate the traffic conditions so as to use engine braking more than the brake pedal;
- above 30 mph (50 km/h), maintain a steady speed.

### 3 CONTROL ACCELERATION AND SPEED

- Up to 30 mph (50 km/h), accelerate so that 5<sup>th</sup> can be quickly reached;
- beyond 30 mph (50 km/h), accelerate moderately and limit the speed.

### 4 MANAGE UPHILL AND DOWNHILL SECTIONS

- When driving downhill, maintain the driving speed;
- when driving uphill, slow down without affecting the traffic flow.

### 5 USE THE ENGINE CONSCIENTIOUSLY

- Switch off the engine if stopped for more than 30 seconds;
- do not run the engine at idle speed (to raise the temperature) before driving, even in winter.

### 6 OPTIMISE YOUR USE OF THE VEHICLE

- Use the heating and air conditioning system only when necessary;
- limit the difference between the interior and exterior temperature to 5°C;
- check the tyre pressures every month;
- do not leave unnecessary loads in the vehicle.

( [www.e-guide.renault.com](http://www.e-guide.renault.com) )



9 9 9 1 0 9 3 5 8 R

**2L**