

User Manual

RIGOL

Publication number DS1-060301
March 2006

DS1000 Series Digital Oscilloscopes

DS1000CD, DS1000C, DS1000MD, DS1000M

- Copyright © RIGOL TECHNOLOGIES, INC. 2006 All Rights Reserved.
- RIGOL products are protected by patent law in and outside of P.R. China.
- Information in this publication replaces that in all previously corresponding material.
- RIGOL Technologies, Inc. reserves the right to modify or change part of or all the specifications and pricing policies at company's sole decision.

***NOTE:** RIGOL is registered trademark of RIGOL TECHNOLOGIES, INC.*

Safety Notices

Review the following safety precautions carefully before operate the instrument to avoid any personal injury or to damage the instrument and any products connected to it.

To avoid potential hazards use the instrument in a manner only as specified by this user's guide.

The instrument should be serviced by qualified personnel only.

To Avoid Fire or Personal Injury

Use proper power cord Use only the power cord designed for your oscilloscope and authorized in your country.

Connect and Disconnect accessories properly. Do not connect or disconnect probes or test leads while they are connected to a voltage source

Ground the instrument This oscilloscope is grounded through the protective earthing conductor of the power cord. To avoid electric shock the grounding conductor must be connected to earth ground. Before making connections to the input or output terminals of the oscilloscope ensure that the instrument is properly grounded.

Connect the probe properly. The probes' ground terminals are at the same voltage level with earth terminal of the instrument. Do not connect the ground terminals to a high voltage.

Observe All Terminal Ratings. To avoid fire or shock hazard, observe all ratings and marks on the instrument. Follow the user's manual for further ratings information before making connections to the instrument.

Do not operate without Covers. Do not operate your oscilloscope with covers or panels removed.

Use Proper Fuse. Use only the fuse type and rating specified for this product.

Avoid Circuit or Wire Exposure. Do not touch exposed connections and components when power is on.

Do not operate with suspected failures. If you suspect damage with this product, have it inspected by qualified service personnel before further operations.

Provide Proper Ventilation. Refer to the manual's installation instructions for details as to the oscilloscope has proper ventilation.

Do not operate in wet/damp conditions

Do not operate in an explosive atmosphere

Keep product surfaces clean and dry

Safety Terms and Symbols

Terms in This Manual. These terms may appear in this manual:



WARNING: Warning statements identify conditions or practices that could result in injury or loss of life.



CAUTION: Caution statements identify conditions or practices that could result in damage to this product or other property.

Terms on the Product: These terms may appear on the product:

DANGER indicates an injury hazard may be immediately accessible.

WARNING indicates an injury hazard may be not immediately accessible.

CAUTION indicates that a potential damage to the instrument or other property might occur.

Symbols on the Product: These symbols may appear on the Instrument:



**Hazardous
Voltage**



**Refer to
Instructions**



**Protective
earth terminal**



**Grounding
Terminal
of Chassis**



**Test
Grounding
Terminal**

General-Purpose Oscilloscopes

RIGOL DS1000-Series Digital Oscilloscopes offer exceptional waveform viewing and measurements in a compact, lightweight package. The DS1000 series are ideal for production test, field service, research and design and all of the applications involving analog/digital circuits test and troubleshooting, as well as education and training.

Each of these oscilloscopes gives you:

- Dual Channel, Bandwidth:
 - 100MHz (DS1102CD, DS1102C, DS1102MD, DS1102M)
 - 60MHz (DS1062CD, DS1062C, DS1062MD, DS1062M)
 - 40MHz (DS1042CD, DS1042C, DS1042MD, DS1042M)
 - 25MHz (DS1022CD, DS1022C, DS1022MD, DS1022M)
- Optional 16 digital channels (Mixed signal oscilloscope), each channel can be turned on or off independently, or in a 8 bit group
- Mono/Color TFT LCD Displays at 320*234 resolution
- USB storage and printing supports, firmware upgradeable via USB connectivity
- Adjustable waveform intensity, more effective waveform viewing
- One-touch automatic setup for ease of use (AUTO)
- Saves 10 Waveforms, 10 setups, supports CSV and bitmap format
- Newly designed Delayed Scan Function, easy to give attention to both details and overview of a waveform
- 20 Automatic measurements
- Automatic cursor tracking measurements
- Waveform recorder, record and replay dynamic waveforms
- User selectable fast offset calibration
- Built-in FFT function, Frequency Counter
- Digital filters, includes LPF, HPF, BPF, BRF
- Pass/Fail Function, optically isolated Pass/Fail output
- Add, Subtract and Multiply Mathematic Functions
- Advanced trigger types include: Edge, Video, Pulse width, Slope, Alternative, Pattern and Duration (Mixed signal oscilloscope)
- Adjustable trigger sensitivity

- Multiple Language User Interface
- Pop-up menu makes it easy to read and easy to use
- Built-in Chinese and English help system
- Easy-to-use file system supports Chinese & English characters key-in

DS1000 Series Digital Oscilloscope accessories:

- Two 1.5 meter, 1:1 10: 1 switchable probes
- Digital test set (Mixed Signal Oscilloscope only, DS1xxxxD), include
A data line (Model: FC1868)
An active logic head (Model: LH1116)
Twenty test wire (Model: LC1150)
Twenty logic clips (Model: TC1100)
- Power cord for country of destination
- User's Manual
- Warranty Card

Content

<i>Safety Notices</i>	II
<i>General-Purpose Oscilloscopes</i>	V
CHAPTER 1: GETTING STARTED	1-1
<i>The Front Panel and the User Interface</i>	1-2
<i>To Inspect the Instrument</i>	1-6
<i>To Perform a Functional Check</i>	1-7
<i>To Compensate Probes</i>	1-9
<i>To Use Digital Leads (Mixed Signal Oscilloscope)</i>	1-10
<i>To Display a Signal Automatically</i>	1-12
<i>To Set Up the Vertical Window</i>	1-13
<i>To Set Up the Horizontal System</i>	1-15
<i>To Trigger the Oscilloscope</i>	1-17
CHAPTER 2: OPERATING YOUR OSCILLOSCOPE	2-1
<i>Understand the vertical system</i>	2-2
<i>Understand the Horizontal System</i>	2-30
<i>Understand the Trigger System</i>	2-36
<i>To Set Up the Sampling System</i>	2-59
<i>To Set Up the Display System</i>	2-63
<i>To Store and Recall Waveforms or Setups</i>	2-65
<i>To Set Up the Utility</i>	2-73
<i>To Measure Automatically</i>	2-91
<i>To measure with cursors</i>	2-98
<i>To use run control buttons</i>	2-105
CHAPTER 3: APPLICATION & EXAMPLES	3-1
<i>Example 1: Taking Simple Measurements</i>	3-1
<i>Example 2: View a signal delay caused by a circuit</i>	3-2
<i>Example 3: Capture a Single-Shot Signal</i>	3-3
<i>Example 4: To reduce the random noise on a signal</i>	3-4
<i>Example 5: Making Cursor Measurements</i>	3-6
<i>Example 6: The application of the X-Y operation</i>	3-8
<i>Example 7: Triggering on a Video Signal</i>	3-10
<i>Example 8: FFT Cursor measurement</i>	3-12

Example 9: Pass/Fail Test 3-13

CHAPTER 4: PROMPT MESSAGES & TROUBLESHOOTING 4-1

Prompting Message 4-1

Troubleshooting..... 4-3

CHAPTER 5: SUPPORT & SERVICE 5-1

CHAPTER 6: APPENDIX 6-1

Appendix A: Specifications 6-1

Appendix B: DS1000-Series Accessories 6-7

Appendix C: General Care and Cleaning 6-8

Index..... i

Chapter 1 : Getting Started

This chapter covers the following topics:

- The front panel and user interface
- To inspect the instrument
- To perform a functional check
- To compensate probes
- To use digital leads (Mixed signal oscilloscope only)
- To display a signal automatically
- To set up the vertical system
- To set up the horizontal system
- To trigger the oscilloscope

The Front Panel and the User Interface

One of the first things you will want to do with your new oscilloscope is to become acquainted with its front panel. This chapter will help you be familiar with the layout of the knobs and keys and how to use them. Read the chapter carefully before further operations.

The front panel has knobs and buttons. The knobs are used most often and are similar to the knobs on other oscilloscopes. The buttons not only let you use some of the functions directly but also bring up soft button menus on the screen, which allow you access to many measurement features associated with advanced functionalities, math, and reference or run control features.

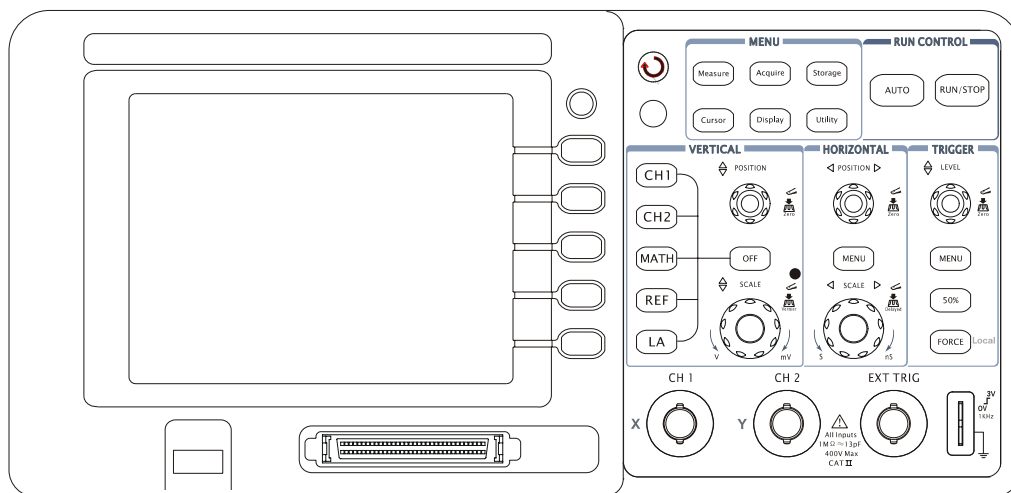

Figure1-1

DS1000-Series Oscilloscope's Front Panel

DS1000 series oscilloscopes provide an easy-to-use user interface, the definitions of the buttons and the knobs are as follows:

Menu buttons: Associated with Measure, Cursor, Acquire, Display, Storage, and

Utility menus.



Vertical buttons: Associated with CH1, CH2, MATH, REF and LA menus, the OFF button can set waveform or menu which currently active off.

Horizontal buttons: Associated with horizontal MENU.

Trigger buttons: Associated with trigger MENU, instant action to set 50% trigger level and FORCE trigger.

Action buttons: Include run control buttons for AUTO and RUN/STOP.

Function buttons: Five grey buttons from top to bottom on the right to the LCD screen, which set choices of operation in the currently active menu.

Knobs: For the adjustment of vertical or horizontal  POSITION,  SCALE and trigger  LEVEL.

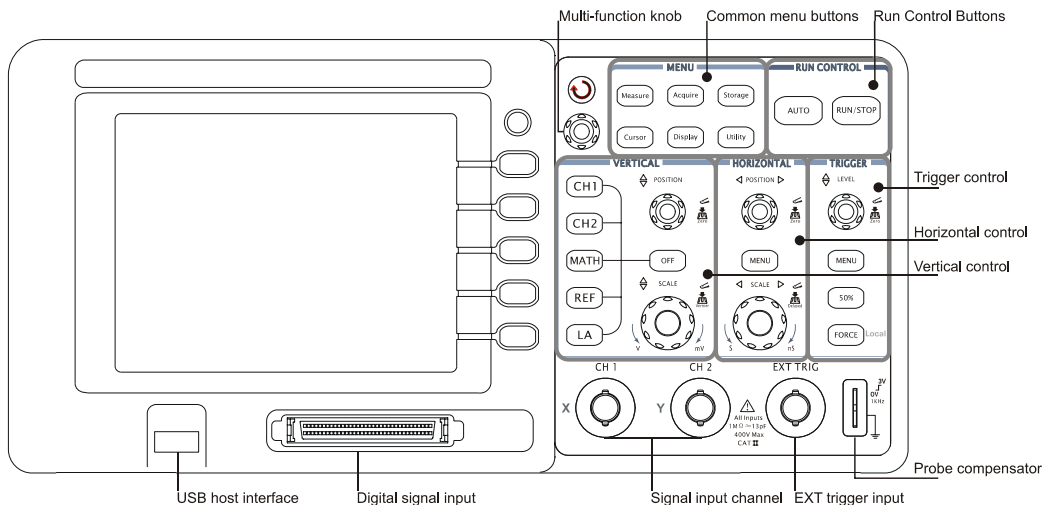

Figure 1-2
Front Panel Controls

Character definitions in this User’s Manual:

Throughout this book, character figures of buttons and knobs are the same to those on front-panel.

A box around the name of the key denotes MENU function buttons on front-panel, such as Measure.

⌚ denotes the multi-function knob ⌚.

⌚POSITION denotes the two POSITION knobs.

⌚SCALE denotes the two SCALE knobs.

⌚LEVEL denotes the LEVEL knob.

The name with a drop shadow denotes the menu operating key, such as WAVEFORM soft key in STORAGE menu.

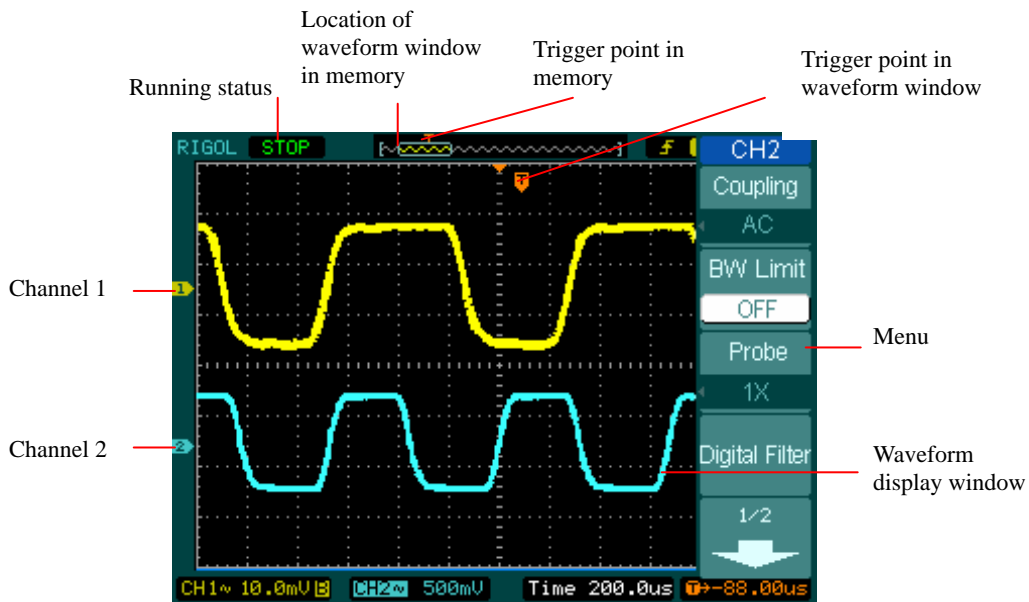

Figure1—3
Display screen (Analog channels only)

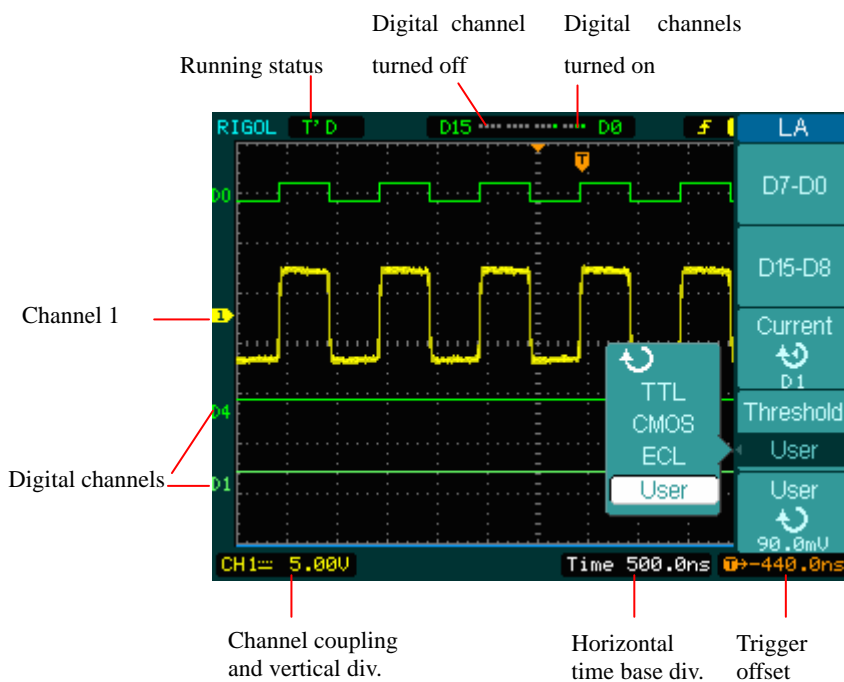

Figure 1-4
User Interface (Analog and Digital channels)

To Inspect the Instrument

After you get a new DS1000 series oscilloscope, please inspect the instrument according to the following steps:

1. Inspect the shipping container for damage.

Keep a damaged shipping container or cushioning material until the contents of the shipment have been checked for completeness and the instrument has been checked mechanically and electrically.

2. Check the accessories.

Accessories supplied with the instrument are listed in "Accessories" in this manual.

If the contents are incomplete or damaged notify your RIGOL Sales Representative.

3. Inspect the instrument.

In case any mechanical damage or defect, or if the instrument does not operate properly or pass performance tests, notify your RIGOL Sales Representative.

If the shipping container is damaged, or the cushioning materials show signs of stress, notify the carrier as well as your RIGOL sales office. Keep the shipping materials for the carrier's inspection.

RIGOL offices will arrange for repair or replacement at RIGOL's option without waiting for claim settlement.

To Perform a Functional Check

Perform this quick functional check to verify that your instrument is operating correctly.

1. Turn on the instrument.

Use only power cords designed for your oscilloscope. Use a power source that delivers 100 to 240 VAC_{RMS}, 45Hz to 440Hz. Turn on the instruments, and wait until the display shows the waveform window. Push the **Storage** button, select **Storage** in the top menu box and push the **Factory** menu box.

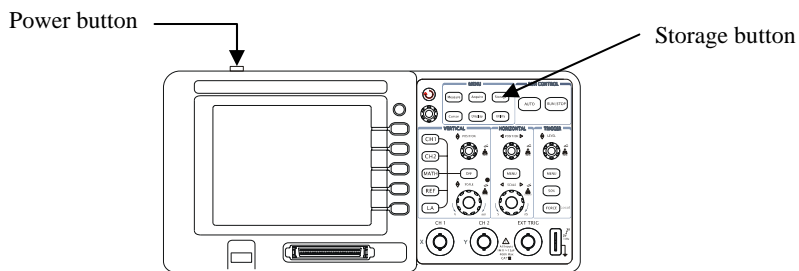

Figure 1-5



WARNING:

To avoid electric shock, be sure the oscilloscope is properly grounded.

2. Input a signal to a channel of the oscilloscope

- ① Set the switch on the probe to 10X and connect the probe to channel 1 on the oscilloscope. To do this, align the slot in the probe connector with the key on the CH 1 BNC, push to connect, and twist to the right to lock the probe in place. Attach the probe tip and ground lead to the PROBE COMP connector.

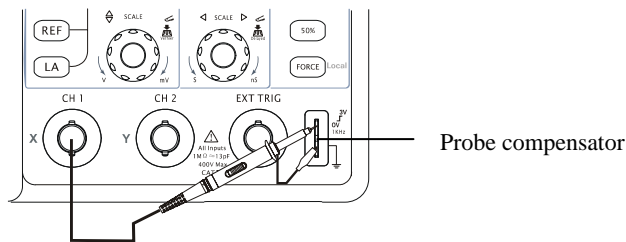

Figure 1-6

② Set the probe attenuation to 10X. To do this, push **CH1** → **Probe** → **10X**.

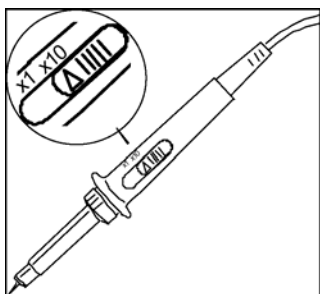

Figure 1-7

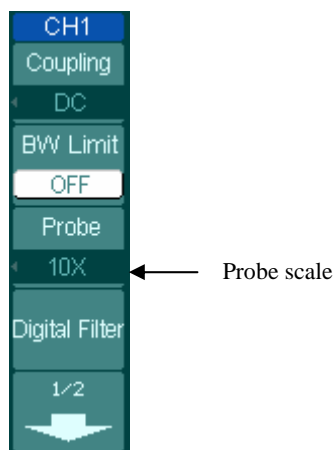

Figure 1-8

- ③ Push the **AUTO** button. Within a few seconds, you could see a square wave in the display (approximately 1 kHz 3 V peak- to- peak).
- ④ Push the **OFF** button or push the **CH1** button again to turn off channel 1, push the **CH2** button to turn on channel 2, repeat steps 2 and 3.

To Compensate Probes

Perform this adjustment to match your probe to the input channel. This should be done whenever you attach a probe for the first time to any input channel.

1. Set the Probe menu attenuation to 10X. Set the switch to 10X on the probe and connect the probe to channel 1 on the oscilloscope. If you use the probe hook-tip, ensure a proper connection by firmly inserting the tip onto the probe. Attach the probe tip to the PROBE COMP connector and the reference lead to the PROBE COMP Ground connector, turn on channel 1, and then press **AUTO**.
2. Check the shape of the displayed waveform.

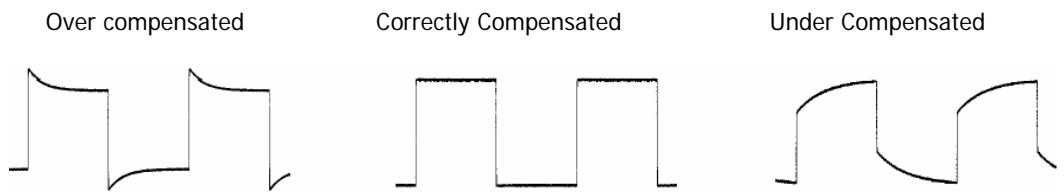

Figure 1-9

3. If necessary, use a non-metallic tool to adjust the trimmer capacitor on the probe for the flattest square wave possible as displayed on the oscilloscope.
4. Repeat as necessary.



WARNING: To avoid electric shock while using the probe, be sure the perfection of the insulated cable, and do not touch the metallic portions of the probe head while it is connected with a voltage source.

3. Connect a test clip to one lead wire; make sure it's connected well.

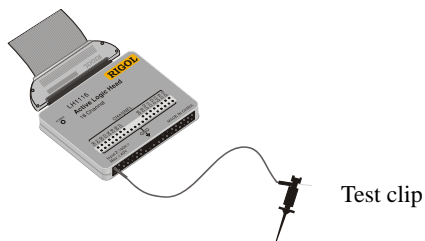

Figure 1-11

4. Test your device with the clip.

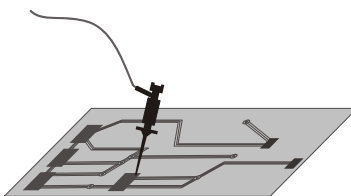

Figure 1-12

5. Remember to connect Ground Channel to the DUT's ground terminal.

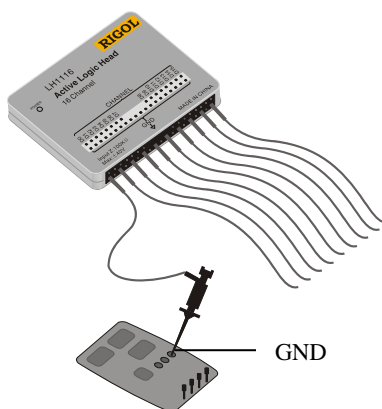

Figure 1-13

To Display a Signal Automatically

The oscilloscope has an Auto feature that sets up the oscilloscope automatically to display the input signal in a best fit. This Auto feature requires the input signal with a frequency of 50 Hz or higher and a duty cycle greater than 1%.

When you press the **AUTO** button, the oscilloscope automatically sets up vertical, horizontal and Trigger controls to display the input signal in the screen for view. You may want to adjust the controls manually if necessary to get the best results.

DS1000 series are two-channel oscilloscopes with an external trigger input. In this exercise you connect a signal to the channel 1 input.

1. Connect a signal to the oscilloscope.
2. Press **AUTO**.

When you press the **AUTO** button, the oscilloscope may change the current settings to display the signal. It automatically adjusts the vertical and horizontal scaling, as well as the trigger coupling, type, position, slope, level, and mode settings.

To Set Up the Vertical Window

Figure 1-14 shows the Channels, MATH, REF, Logic Analyzer and OFF buttons and vertical **POSITION**, **SCALE** knobs. The following exercise guides you through the vertical buttons, knobs, and status bar. It will help you be familiar with the setting of the vertical parameters.

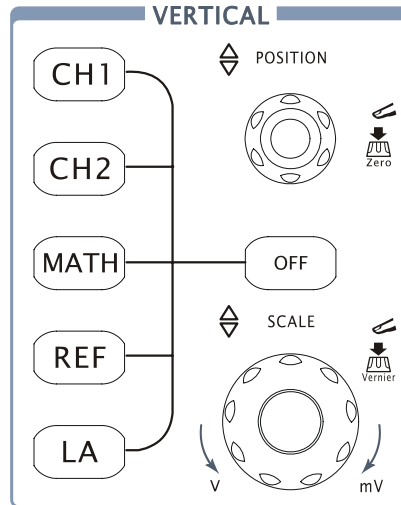

Figure 1-14

1. Center the signal on the display with the **POSITION** knob.



The **POSITION** knob moves the signal vertically, and it is calibrated. Notice that as you turn the **POSITION** knob, a voltage value is displayed for a short time indicating how far the ground reference is located from the center of the screen. Also notice that the ground symbol on the left side of the display moves in conjunction with the **POSITION** knob.

Measurement hints

If the channel is DC coupled, you can quickly measure the DC component of the signal by simply noting its distance from the ground symbol.



If the channel is AC coupled, the DC component of the signal is blocked, allowing you to use greater sensitivity to display the AC component of the signal.

Vertical offset back to 0 shortcut key

Turn the  POSITION knob to change the vertical display position of channel and press the  POSITION knob to set the vertical display position back to 0 as a shortcut key, this is especially helpful when the trace position is far out of the screen and want it to get back to the screen center immediately.

2. Change the vertical setup and notice that each change affects the status bar differently.

You can quickly determine the vertical setup from the status bar in the display.

- Change the vertical sensitivity with the  SCALE knob and notice that it causes the status bar to change.
- Press **CH1**.
- A soft button menu appears on the display, and the channel turns on (or remains on if it was already turned on).
- Toggle each of the soft buttons and notice which button cause the status bar to change. Channel 1 and 2 have a vernier soft button that allows the  SCALE knob to change the vertical step size in smaller increments. To press Volts/Div soft button, you can change the step size into **Fine** or **Coarse** status.
- Press **OFF** button to turn the channel off.

Coarse/Fine Shortcut key

You can set the Coarse/Fine vertical control not only on the Volts/Div item in the CH1 or CH2 menus, but also by simply pressing the vertical  SCALE knob.

To Set Up the Horizontal System

Figure 1-15 shows the **MENU** button, **POSITION** knob and **SCALE** knobs of horizontal system. The following exercise guides you through these buttons, knobs, and status bar.

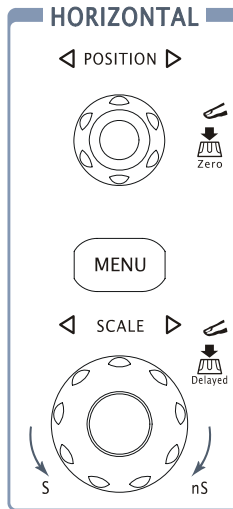

Figure 1—15

1. Turn the **SCALE** knob and notice the change it makes to the status bar.

The horizontal **SCALE** knob changes the sweep speed in a 1-2-5 step sequence, and the value is displayed in the status bar. The time base ranges of the DS1000 series are listed as follows. The horizontal scan speed is from 5ns/div* to 50s/div.

* **NOTE:** The speed of horizontal scan varies by different models.

Delayed Scan Shortcut key

To press the **SCALE** knob in the horizontal control area on the front-panel is another way to enter or exit Delayed Scan mode and it is equal to the following menu operations, **MENU** → **Delayed**.

2. The horizontal  POSITION knob moves displayed signal horizontally on waveform window

Horizontal offset back to 0 shortcut key

Press the  POSITION knob to set the horizontal offset to 0 as a shortcut key, this is especially helpful when the trigger point is far out of the screen and want it to get back to the screen center immediately.

3. Press the  key to display the TIME menu.

In this menu, you can enter or exit the Delayed Scan mode, set the display to Y-T, X-Y or ROLL mode, and turn the horizontal  POSITION knob to adjust trigger offset.

Horizontal position control

Trig-Offset: In this setting, the trigger position will be changed horizontally when you turn the  POSITION knob.

To Trigger the Oscilloscope

Figure 1-16 shows the trigger control area on the front panel, it has a trigger level knob and three soft buttons. The following exercise guides you through these trigger buttons, knobs, and status bar.

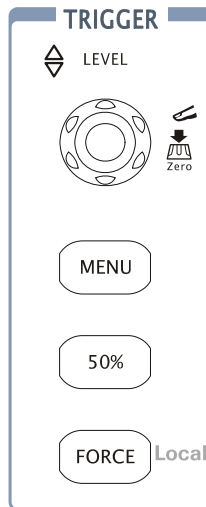

Figure 1-16

1. Turn the trigger Level knob and notice the changes it makes to the display.

On the DS1000 series oscilloscopes, as you turn the **LEVEL** knob or press the **50%** menu button, two things happen on the display for a short time. First, the trigger level value is displayed at the bottom-left of the screen. If the trigger is DC coupled, it is displayed as a voltage value. If the trigger is AC coupled or LF reject, it is displayed as a percentage of the trigger range. Second, a line is displayed showing the location of the trigger level (as long as AC coupling or low frequency reject are not selected).

Trigger Level to 0 Shortcut key

Turn the **LEVEL** knob to change trigger level value and press the **LEVEL** knob to set trigger level back to 0 as a shortcut key.

2. Change the trigger setup and notice these changes affect the status bar differently.

- Press **MENU** button in the trigger control area.
- A soft button menu appears on the display showing the trigger setting choices. Figure 1-17 displays this trigger menu.

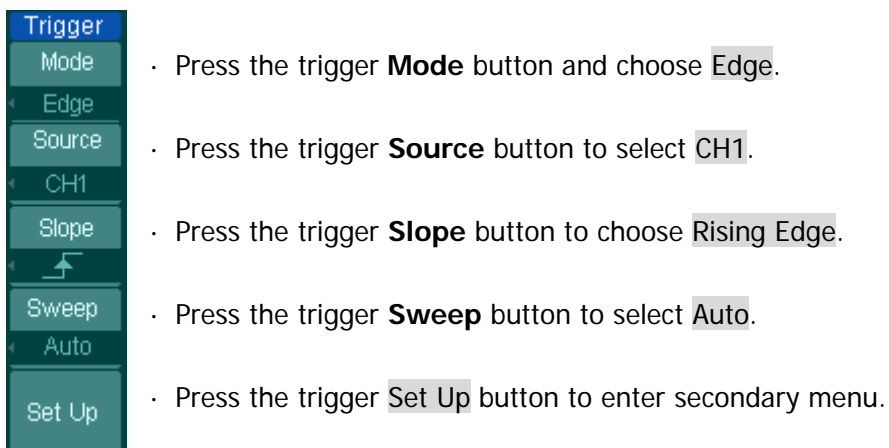

Figure 1-17

NOTE: The trigger type, slope and source change in conjunction with the status bar on the top-right of the screen.

3. Press **50%**

This key is an action button. Every time you press the **50%** button, the oscilloscope sets the trigger level to the center of the signal.

4. Press **FORCE**

Press this button starts an acquisition regardless of an adequate trigger signal, usually used in "Normal" or "Single" trigger mode. This button has no effect if the acquisition is already stopped.

Key point:

Holdoff: A time interval before the oscilloscope response to next trigger signal. During this holdoff period, the trigger system becomes "blind" to trigger signals. This function helps to view complex signals such as an AM waveform. Press **Holdoff** button to activate (⌚) knob, then turn it to adjust Holdoff time.

Test Equipment Depot - 800.517.8431 - 99 Washington Street Melrose, MA 02176

FAX 781.665.0780 - TestEquipmentDepot.com





Chapter 2 : Operating Your Oscilloscope

By now you have got a brief understanding of DS1000 series with the VERTICAL, HORIZONTAL, and TRIGGER groups of the front-panel buttons. You should also know how to determine the setup of the oscilloscope by viewing the status bar.

This chapter takes you through all groups of front-panel buttons, knobs, and menus. You will also further your knowledge of the operation hints by reading this guide.

We recommend you perform all of the following exercises so that you could get the most out of the powerful measurement capabilities of your oscilloscope.

This chapter covers the following topics:

- Understand the vertical system (**CH1**、**CH2**、**MATH**、**REF**、**LA** (Mixed Signal Oscilloscope)、**OFF** 、
Vertical  **POSITION**、Vertical  **SCALE**)
- Understand the horizontal system (**MENU**、Horizontal  **POSITION**、
Horizontal  **SCALE**)
- Understand the trigger system ( **LEVEL**、**MENU**、**50%**、**FORCE**)
- To set up the sampling system (**Acquire**)
- To set up the display system (**Display**)
- To save and recall waveforms, CSV format, bmp format and other setups (**Storage**)
- To set up utility (**Utility**)
- To measure automatically (**Measure**)
- To measure with cursors (**Cursor**)
- To use run control buttons (**AUTO**、**RUN/STOP**)

Understand the vertical system

I . Settings of the channels

Each channel of DS1000 has an operation menu and it will pop up after pressing **CH1** or **CH2** button. The settings of all items in the menu are shown in the table below.

Figure 2-1 Table2-1





Menu	Settings	Comments
Coupling	AC	Blocks the DC component of the input Signal
	DC	Passes both AC and DC components of the input signal
	GND	Disconnects the input signal
BW Limit	ON	Limits the channel bandwidth to 20MHz to reduce display noise.
	OFF	Get full bandwidth.
Probe	1X	Set this to match your probe attenuation factor to make the vertical scale readout correct
	10X	
	100X	
	1000X	
Digital filter		Setup digital filter(See table 2-4)
	1/2	Go to the next menu page(The followings are the same, no more explanation)

Figure 2-2 Table2-2



Menu	Settings	Comments
	2/2	Back to the previous menu page (The followings are the same, no more explanation)
Volts/Div	Coarse Fine	Selects the resolution of the  SCALE knob Defines a 1-2-5 sequence. To change the resolution to small steps between the coarse settings.
Invert	ON OFF	Turn on the invert function. Restore to original display of the waveform.

1. Channel coupling

To use CH1 as an example, input a sine wave signal with DC shift

Press **[CH1]**→**Coupling**→**AC** to set CH1's coupling as "AC". In this setting, it blocks the DC component of the input signal.

The waveform is displayed as Figure 2-3:

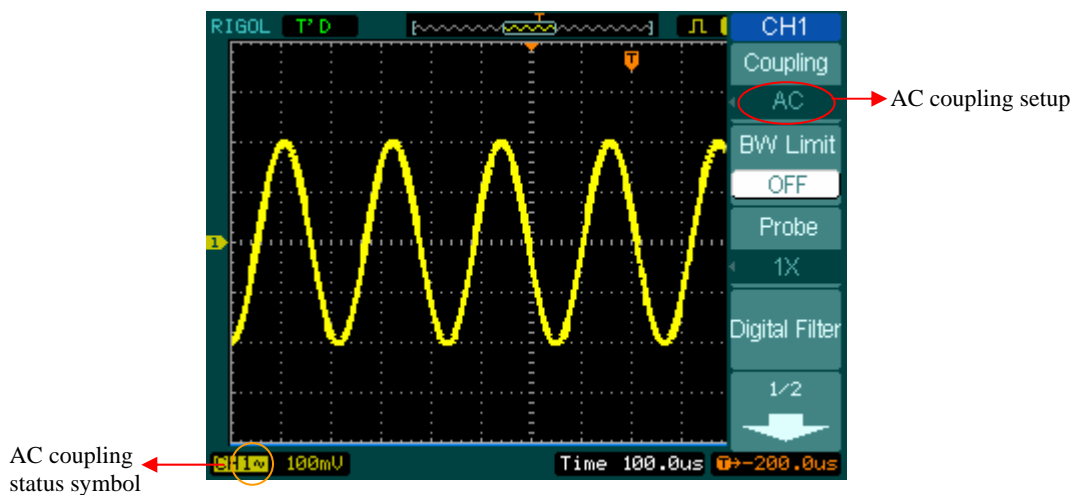

Figure 2-3

Press **[CH1]**→**Coupling**→**DC**, to set CH1's coupling as "DC". In this setting, it passes both AC and DC components of the input signal.

The waveform is displayed as Figure 2-4:

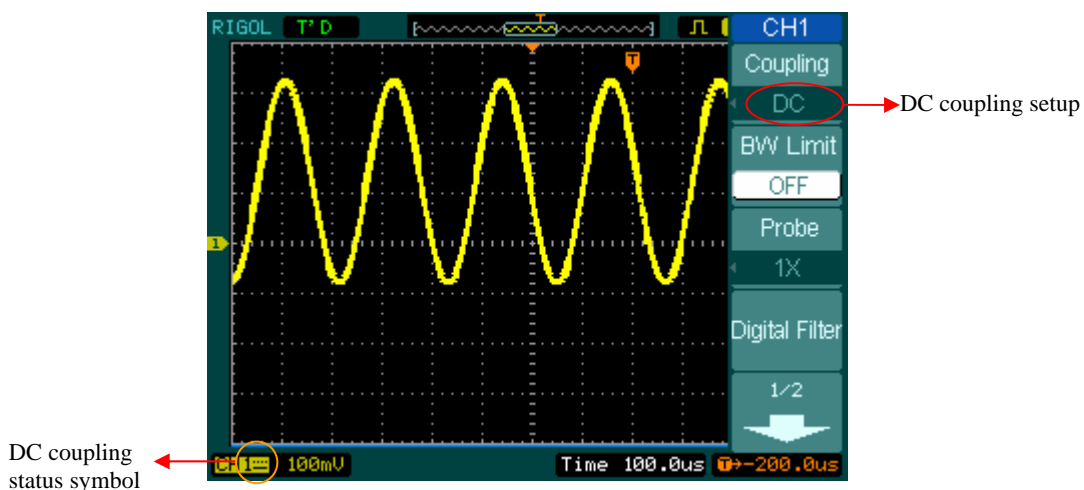

Figure 2-4

Press **[CH1]** → **Coupling** → **GND**, to set CH1's coupling as "GND". In this setting, it disconnects the input signal.

The screen displays as Figure 2-5:

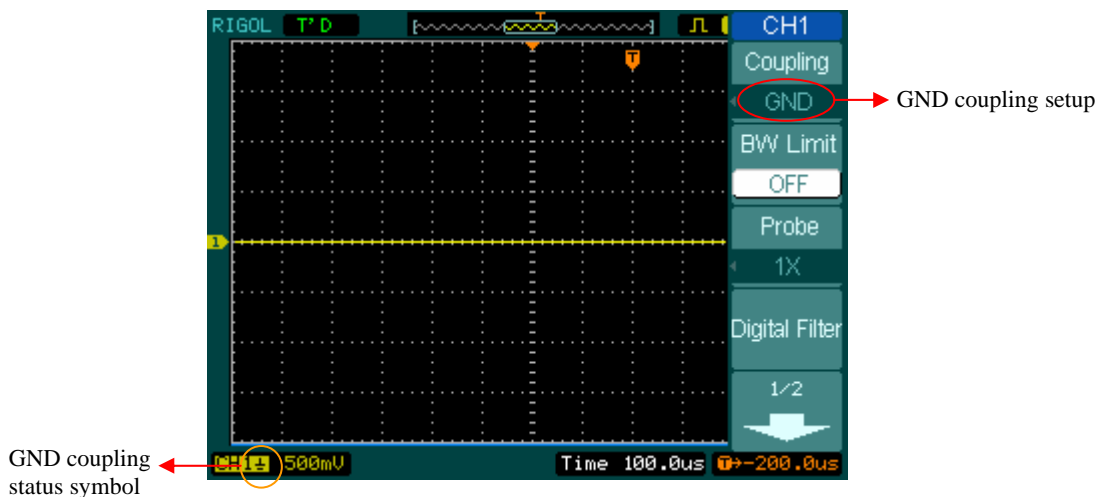
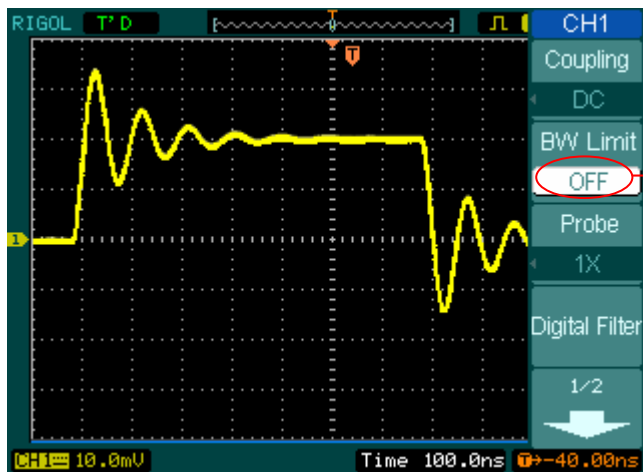

Figure 2-5

2. Set up the channel bandwidth limit

To use CH1 as an example, input a signal that contains high frequency component. Press **CH1**→**BW Limit**→**OFF** , to set up bandwidth limit to “OFF” status. The oscilloscope is set to full bandwidth and the high frequency component in the signal will pass.

The waveform is displayed as Figure 2-6:



Turn off the BW limit

Figure 2-6

Press **CH1**→**BW Limit**→**ON**, to set up bandwidth limit to “ON” status. It will reject the frequency component higher than 20MHz.

The waveform is displayed as Figure 2-7:

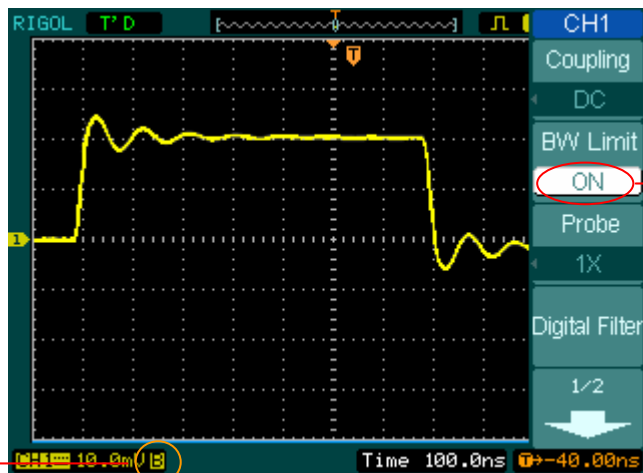

20M BW limit

Mark of BW limit

3. Probe Attenuation Setting

When using a probe, the oscilloscope allows you to select the attenuation factor for the probe. The attenuation factor changes the vertical scaling of the oscilloscope so that the measurement results reflect the actual voltage levels at the probe tip.

To change (or check) the probe attenuation setting, press the CH1 or CH2 button (according to which channel you are using), toggle the **Probe** soft button to change the attenuation factor to match the probe you are using.

This setting remains in effect until changed again.

Figure 2-8 gives an example for using a 1000:1 probe and its attenuation factor.

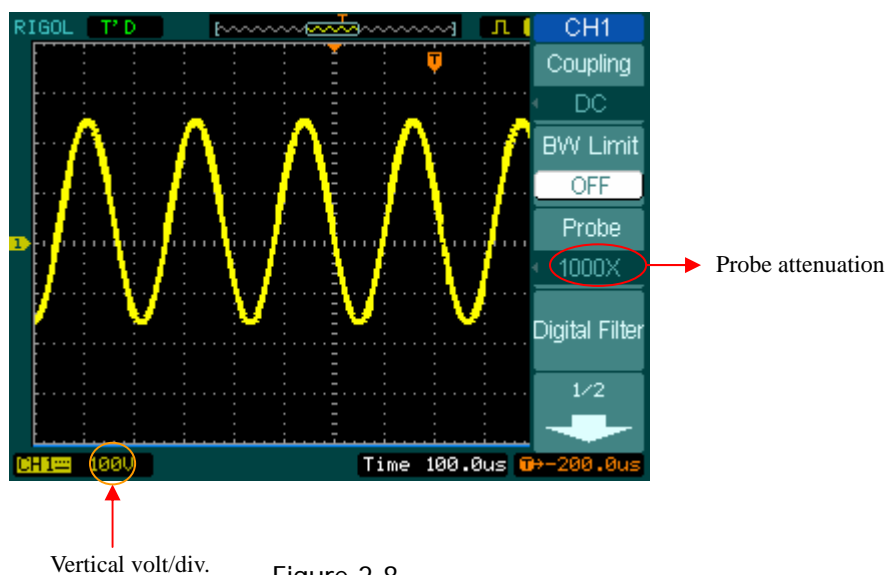

Figure 2-8

Table 2-3

Probe attenuation factors	Corresponding settings
1:1	1X
10:1	10X
100:1	100X
1000:1	1000X

4. Volts/Div settings

The **Volts/Div** control has **Coarse** or **Fine** configuration. The Vertical Sensitivity is 2mv—5V/div.

Coarse: It is the default setting of Volts/Div, and it makes the vertical scaling in a 1-2-5-step sequence from 2mV/div, 5mV/div, 10mV, to 5 V/div.

Fine: This setting changes the vertical scale to small steps between the coarse settings. It will be helpful when you need to adjust the waveform's vertical size in smooth steps

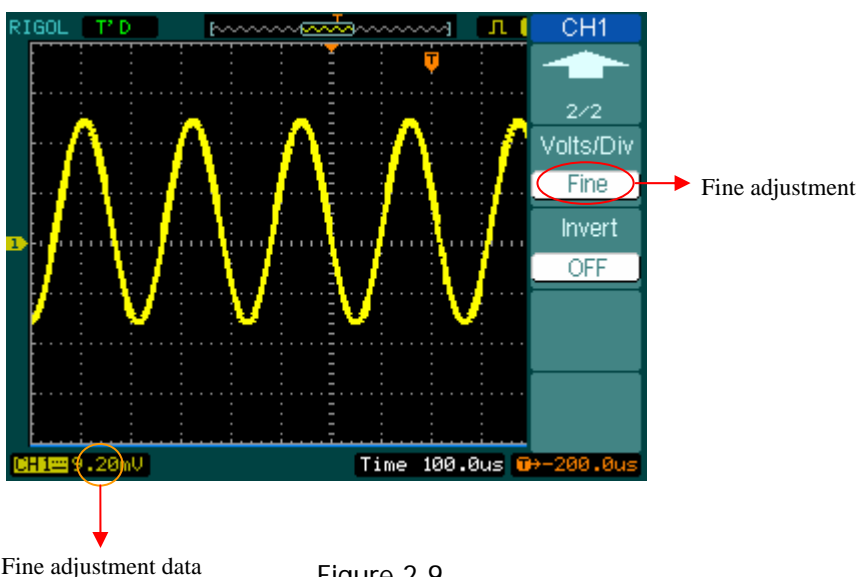



Figure 2-9

Coarse/Fine Shortcut key:

To change Coarse/Fine setting, not only by menu but also by pressing vertical  **SCALE** knob

5. To invert a waveform

Invert turns the displayed waveform 180 degrees, as respect to the ground level. When the oscilloscope is triggered on the inverted signal, the trigger is also inverted.

Figure 2-10 and 2-11 show the changes after inversion.

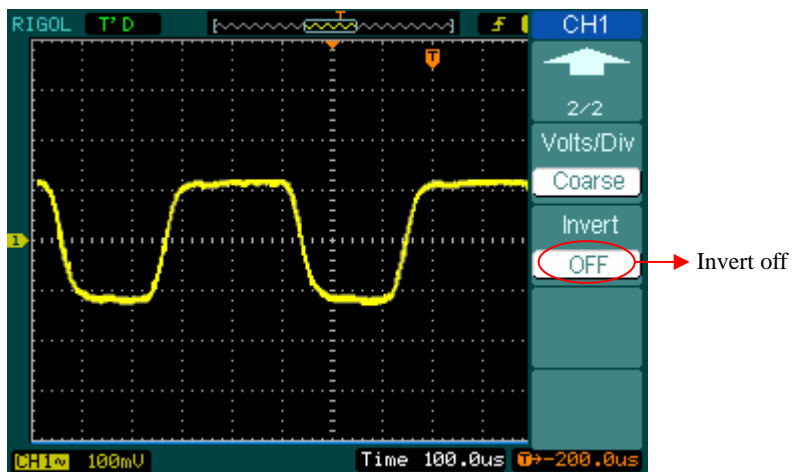

The waveform before inversion

Figure 2-10

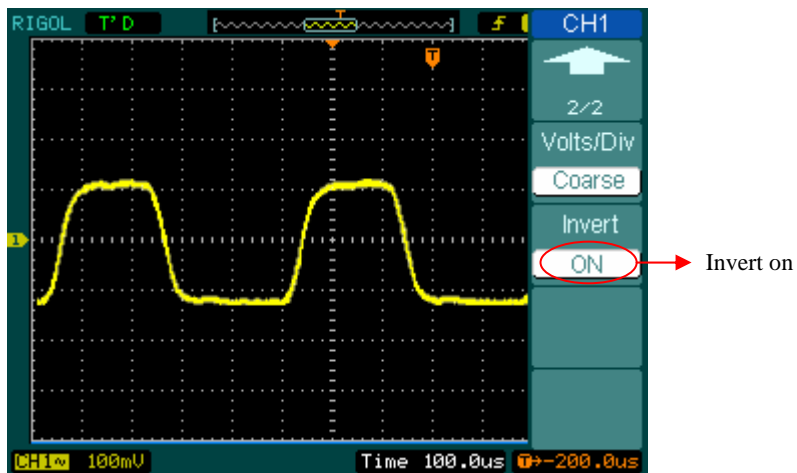

The waveform after inversion

Figure 2-11

Digital Filter:

Press **CH1** → Digital filter, display the digital filter menu. Turn (↻) knob to set high and low limit of frequency.

Figure 2-12

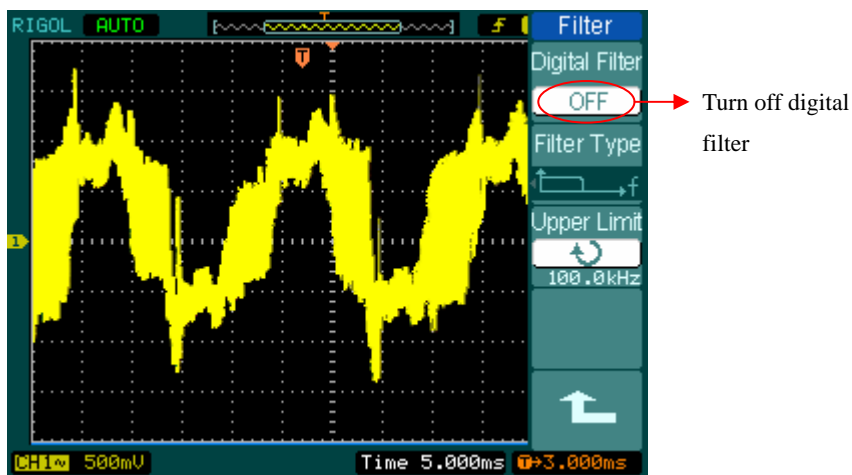

Figure 2-13

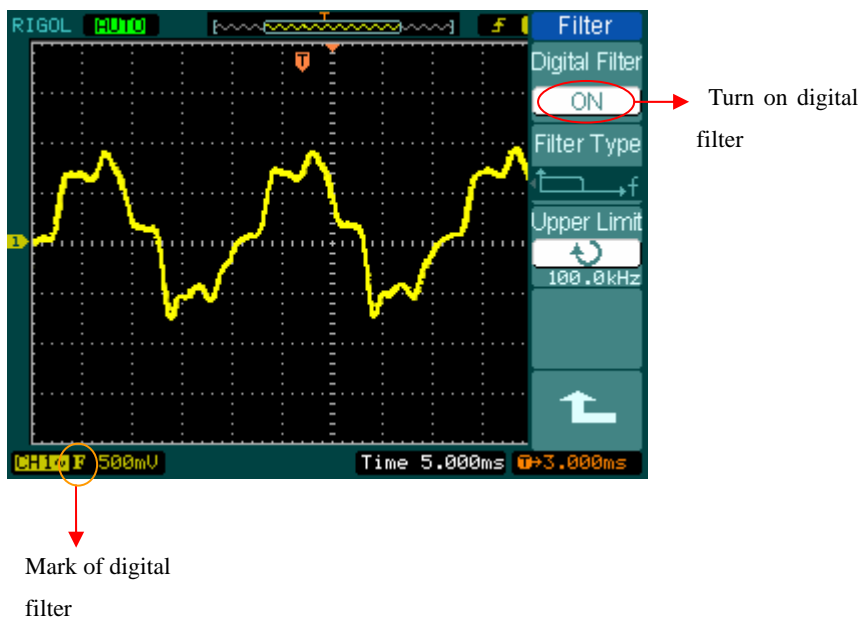

Figure 2-14 Table 2-4



Menu	Settings	Comments
Digital Filter	On Off	Turn on the digital filter Turn off the digital filter
Filter Type	f f f f	Setup as LPF (Low Pass Filter) Setup as HPF(High Pass Filter) Setup as BPF (Band Pass Filter) Setup as BRF(Band Reject Filter)
Upper limit	 <frequency>	Turn () knob to set high limit
Lower limit	 <frequency>	Turn () knob to set low limit
		Back to higher level menu(The followings are the same, no more explanation)

II. Math functions

The mathematic functions include “add”, “subtract”, “multiply” and “FFT” for CH1 and CH2. The mathematic result can also be measured by grid and cursor.

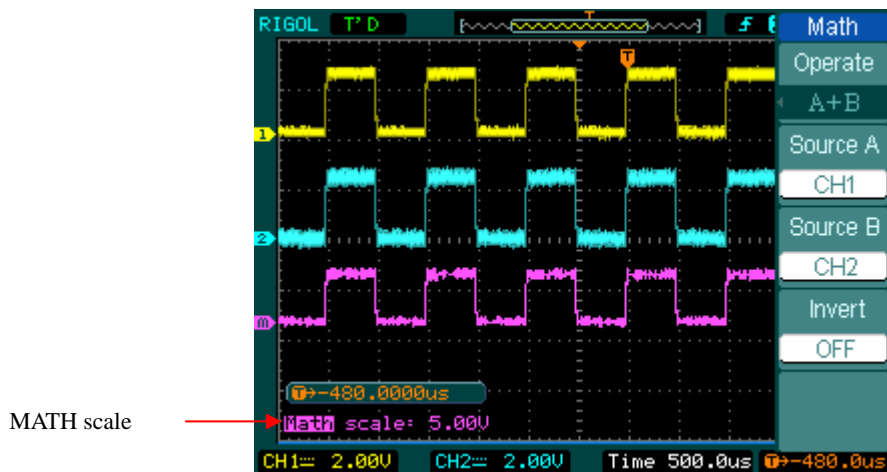

Figure 2-15

Figure 2-16 Table 2-5

Menu	Settings	Comments
Operation	A+B	Add source A and source B
	A-B	Subtract source B from source A
	AxB	Multiply source B by source A
	FFT	Fast Fourier Transform
Source A	CH1 CH2	Define CH1 or CH2 as source A
Source B	CH1 CH2	Define CH1 or CH2 as source B
Invert	ON OFF	Invert the MATH waveform. Restore to original waveform display.

I. Using the FFT

The FFT (Fast Fourier Transform) process mathematically converts a time-domain signal into its frequency components. FFT waveforms are useful in the following applications:

- Measuring harmonic content and distortion in systems
- Characterizing noise in DC power supplies
- Analyzing vibration

Figure 2-17 Table2-6



Menu	Settings	Comments
Operate	A+B A- B AxB FFT	Add source A to source B Subtract source B from source A Multiply source B by source A Fast Fourier Transform
Source	CH1 CH2	Define CH1 or CH2 as FFT source
Window	Rectangle Hanning Hamming Blackman	Select window for FFT
Display	Split Full screen	Display FFT waveform on half screen Display FFT waveform on full screen
Scale	Vrms dBVrms	Set "Vrms " as vertical unit Set "dBVrms " as vertical unit

Key points for FFT

- 1 Signals that have a DC component or offset can cause incorrect FFT waveform component magnitude values. To minimize the DC component, choose **AC** Coupling on the source signal.
- 2 To reduce random noise and aliases components in repetitive or single-shot events, set the oscilloscope acquisition mode to average.
- 3 To display FFT waveforms with a large dynamic range, use the dBVrms scale. The dBVrms scale displays component magnitudes using a log scale.

Selecting an FFT Window

DS1000 series oscilloscopes provide four FFT windows. Each window is a trade-off between frequency resolution and amplitude accuracy. What you want to measure and your source signals characteristics help determine which window to use. Use the following guidelines to select the best window.

Table2-7

Window	Features	Best for measuring
Rectangle	Best frequency resolution and worst magnitude resolution. This is essentially the same as no window.	Transients or bursts, the signal levels before and after the event are nearly equal. Equal-amplitude sine waves with fixed frequencies. Broadband random noise with a relatively slow varying spectrum.
Hanning Hamming	Better frequency, poorer magnitude accuracy than Rectangular. Hamming has slightly better frequency resolution than Hanning.	Sine, periodic, and narrow-band random noise. Transients or bursts where the signal levels before and after the events are significantly different.
Blackman	Best magnitude, worst frequency resolution.	Single frequency waveforms, to Find higher order harmonics.

Key points:

FFT Resolution: the quotient between sampling rate and number of FFT points. With a fixed FFT points, the lower sampling rate results in better resolution.

Nyquist Frequency

The highest frequency that any real-time digitizing oscilloscope can acquire without aliasing. It's normally half of the sample rate. This frequency is called the Nyquist frequency. Frequency above the Nyquist frequency will be under sampled, causing a situation known as aliasing.

II. Using REF

Reference Waveforms are saved waveforms to be selected for display. The reference function will be available after saving the selected waveform to non-volatile memory.

Press **REF** button to display reference waveform menu.

Figure 2-18 Table2-8 when using internal memory

REF	Source	CH1	Location	Internal	Save	Imp./Exp.	Reset
Menu	Settings	Comments					
Source	CH1	Select channel1 as REF channel					
	CH2	Select channel2 as REF channel					
	MATH/FFT	Select Math/FFT as REF channel					
	LA	Select LA as REF channel(Mixed Signal Oscilloscope)					
Location	Internal	Select memory location in scope					
	External	Select memory location out scope					
Save	Save REF waveform						
Imp./Exp.	Go to import/export menu(see table 2-10)						
Reset	Reset REF waveform						

Figure 2-19 Table 2-9 when using external memory

REF	Source	CH1	Location	External	Save	Import	Reset
Menu	Settings	Comments					
Source	CH1	Select channel1 as REF channel					
	CH2	Select channel2 as REF channel					
	MATH/FFT	Select Math/FFT as REF channel					
	LA	Select LA as REF channel(Mixed Signal Oscilloscope)					
Location	Internal	Select memory location in scope					
	External	Select memory location out scope					
Save	Save REF waveform to outer memory location						
Import	Go to import menu(see table 2-14)						
Reset	Reset REF waveform						

Import and Export

Press **REF** → **Imp./Exp.** and go to the following menu.

Figure 2-20 Table 2-10

Menu	Settings	Comments
Explorer	Path Directory File	Switch to Path, directory or file
Export		Export the REF file from internal memory to export memory (see table 2-11)
Import		Import the REF file to internal memory
Delete File		Delete file



The figure of import and export as following



Figure 2-21

Export

Press **REF** → **Imp./Exp.** → **Export** and go to the following menu.

Figure 2-22

Table 2-11



Menu	Settings	Comments
↑		Move the cursor up
↓		Move the cursor down
✕		To delete chosen letter
Save		Execute the operation

The figure of export as following.



Figure 2-23

Save to External Memory

Press **REF** → **Save** and go to the following menu.

Figure 2-24 Table 2-12



Menu	Settings	Comments
Explorer	Path Directory File	Switch among Path, Directory and File
New File (Folder)		Set up new file in Path and File. Set up new folder in directory.
Delete File(Folder)		Delete file(Folder)

The figure of Save as following:



Figure 2-25

New File (or New Folder)

Press **REF** → **Save** → **New File** (or **New Folder**) and go to the following menu.

Figure 2-26

Table 2-13



Menu	Settings	Comments
↑		Move the cursor up
↓		Move the cursor down
✕		To delete chosen letter
Save		Execute the operation

The figure of key in as following

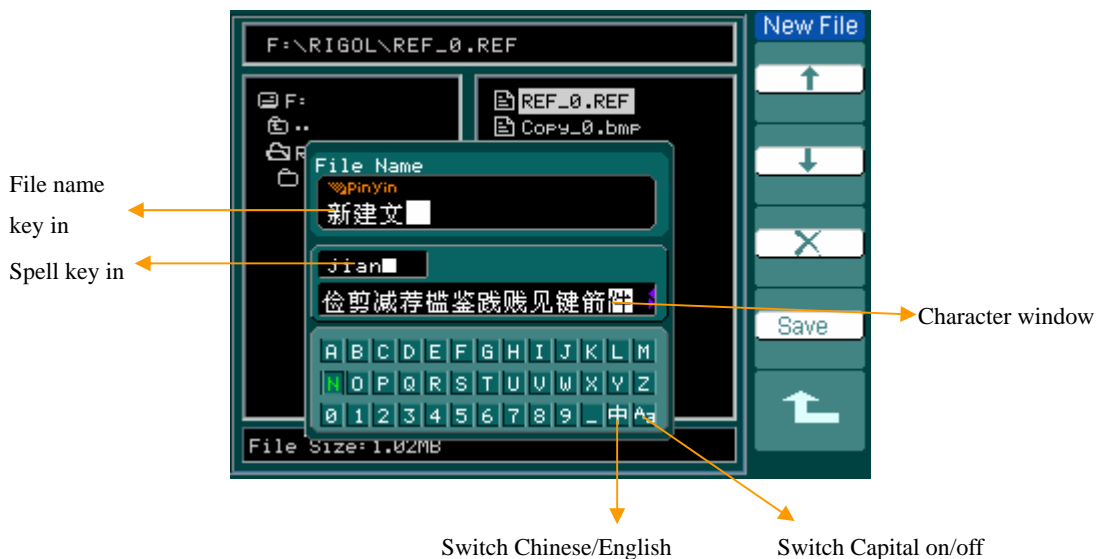

Figure 2-27

Import

Press **REF** → **Import** and go to the following menu.

Figure 2-28

Table 2-14



Menu	Settings	Comments
Explorer	Path Directory File	Switch among Path, Directory and File
Import		Import the REF file into internal memory

The figure of import as following.



Figure 2-29

Displaying a Reference Waveform.

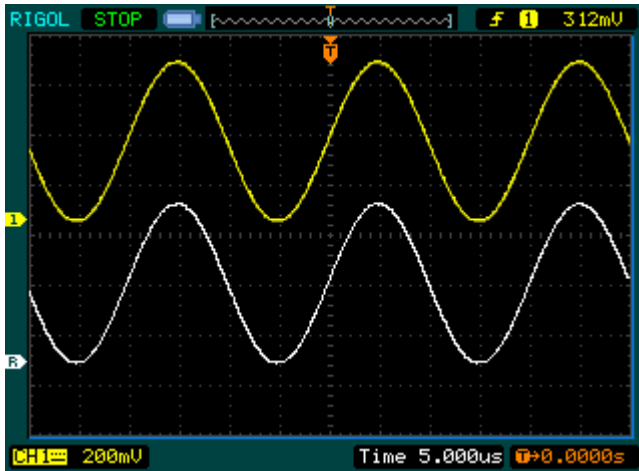

Figure 2-30

1. Push **REF** button to show the reference waveform menu.
2. Press soft button 1 to select **CH1**, **CH2**, **MATH**, **FFT** or **LA** (Mixed Signal Oscilloscope) to choose the REF channel you want.
3. Turn vertical **POSITION** and vertical **SCALE** to adjust the REF waveform to a suitable position.
4. Select the save location of REF waveform by press soft button No. 2.
5. Save the waveform being displayed on the screen as REF by press soft button No.3.

NOTE:





The reference function is not available in X-Y mode.

III. Set up LA channel (mixed signal oscilloscope)



Single channel or group channels can be chosen ON or OFF, and also can set the size of waveform. Change display location of digital channel on screen and select threshold style.

Press **LA** function button and go to the following menu.

Figure 2-31 Table 2-15

Menu	Settings	Comments
D7-D0		Set up channel group D7-D0 (see table 2-16)
D15-D8		set up channel group D15-D8 (see 2-17)
Current	 <D15-D0>	Select channel by turning  knob
Threshold	TTL CMOS ECL User	Select mode of whole digital channels. The threshold voltage can set by user when in user-defined style.
user	 <Threshold Voltage>	Set threshold voltage by turning  knob.

1. Display and re-line up the digital channels

- (1) Press **LA** → **D7-D0** or **D15-D8** and go to the group channel setting menu. Turn on or turn off the display of the digital channels.
- (2) Press **LA** → **current** and choose digital channel by turning  knob. The chosen channel will be shown in red (Color LCD).
- (3) Turn vertical  **POSITION** knob to re-position the channel in screen.

The figure of menu shows as follow.

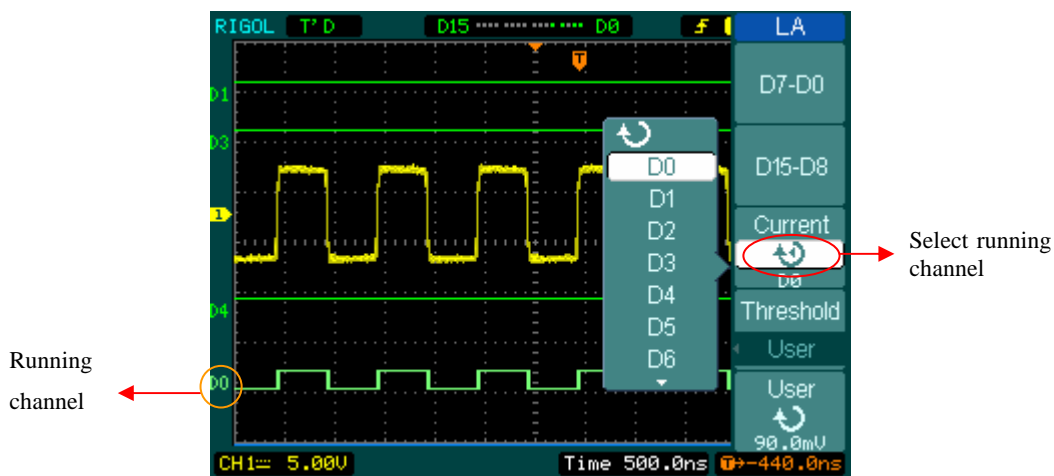

Figure 2-32

2. Set threshold mode of digital channels

Press **LA** → **Threshold**, select logic standard or **User** to define your own threshold voltage.

The figure of menu shows as follow.

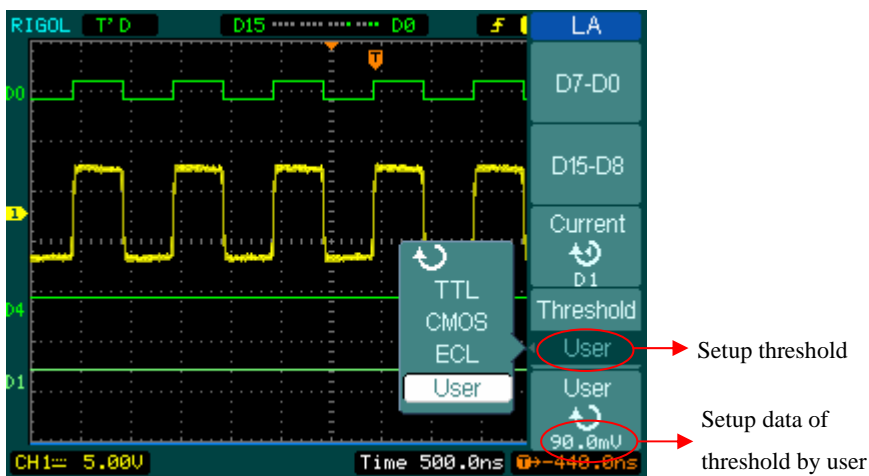

Figure 2-33

Threshold explanation

LOGIC STANDARD	THRESHOULD VLOTAGE
TTL	1.4V
CMOS	2.5V
ECL	-1.3V
User	-8V to +8V

Set up Cannel Group

Press **LA** → **D7-D0** or **D15-D8**, turn on/off the channel single, or in a group. Also you can change the size of waveforms in 8 bits as a group. See table 2-16 and 2-17

Figure 2-34 Table 2-16







Menu	Settings	Comments
channel	D7-D0	Turn on or off single channel of D7-D0
D7-D0	Turn on Turn off	Turn on or off all 8 channels together
Size	 	Display 8 channels in a single screen Display 16 channels in a single screen
Reset		Reset waveform of channel D7-D0

Figure 2-35 Table 2-17



Menu	Settings	Comments
channel	D15-D8	Turn on or off single channel of D15-D8
D15-D8	Turn on Turn off	Turn on or off 8 channels together
Size	 	Display 8 channels in a single screen Display 16 channels in a single screen
Reset		Reset waveform of channel D15-D8

1. Turn on or off a single logic channel

press **LA** → **D7-D0** → **Channel**, and choose the wanted channel by turning (↻) knob. Press No. 1 soft button or push down (↻) knob to turn on /off the channel. When the channel is on, we can see the mark (■). When the channel is off, the mark shown as (□).

As figure 2-36 shows.

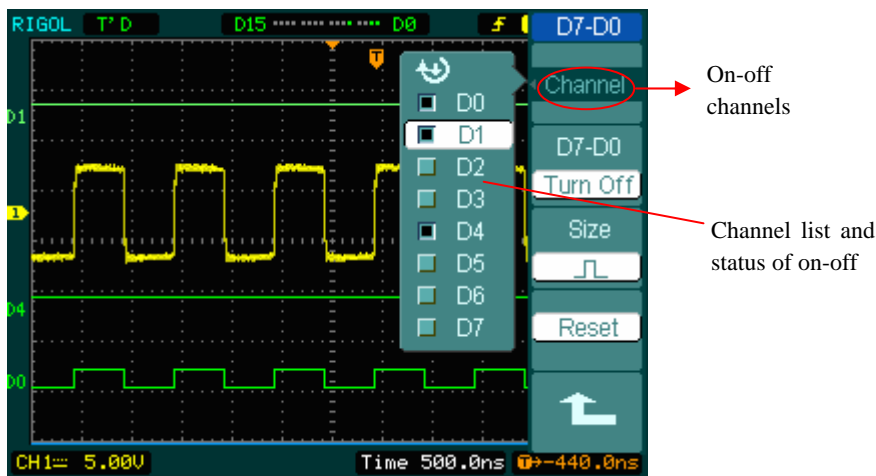



Figure 2-36

2. Force turn on or off all logic channels

Press **LA** → **D7-D0** → **D7-D0** → **Turn On / Turn Off** (or **D15-D8** → **D15-D8** → **Turn On / Turn Off**) will force to turn all the channels on/off. If you want to turn on/off any single channel instead, select the **Channel** by turning (↻) knob, then press No. 1 soft button or (↻) knob.

3. Set up the viewing size of logic channels:

Press **LA** → **D7-D0** → **Size**, or **D15-D8** → **Size**, to select wave size of logic channels.

Select  to view 8 channels on the screen; Select  to view all of the 16 channels on the screen.

4. Reset the logic channels display:

Press **LA** → **D7-D0** → **Reset**, or **D15-D8** → **Reset** to reset the display of logic channels.

IV. Turn on/off channels

The CH1, CH2, Ext. Trigger and LA (Mixed Signal Oscilloscope) channels on DS1000 series are input channels. All functionalities applied will be based on operating the instrument with channels. So MATH and REF can be regarded as relatively isolated channels.

To turn on/off any one of the channels, press the corresponding button on the front panel. The key backlight indicates the channel is currently active. Press the button again to turn the channel off. Or when channel is currently selected, press **OFF** will turn the channel off as well, and the key backlight also goes off.



Table 2-18

Channel Mode	Settings	Status Indicator	
		DS1000 MONO	DS1000 COLOR
Channel 1 (CH1)	ON	CH1 (black letter)	CH1 (black letter)
	Selected	CH1 (white letter)	CH1 (yellow letter)
	OFF	No indicator	No indicator
Channel 2 (CH2)	ON	CH 2 (black letter)	CH2 (black letter)
	Selected	CH2 (white letter)	CH2 (blue letter)
	OFF	No indicator	No indicator
MATH	ON	Math (black letter)	Math (black letter)
	Selected	Math (white letter)	Math (purple letter)
	OFF	No indicator	No indicator

Note:

The status indicators of the DS1000 Mono series in the above table are displayed when the Screen is set as Normal. The channel status symbol is displayed at the lower-left of the screen. Pressing **LA** will turn all the digital channels on/off

V. Using Vertical POSITION and SCALE

You can use the vertical controls to display waveforms, adjust vertical  SCALE and  POSITION, and set input parameters.

1. Using vertical POSITION knob.

The vertical  POSITION can change the position of waveforms in all channels (including MATH, REF and LA). The resolution of the knob changes according to the change of the vertical level (The digital channels of Mixed Signal Oscilloscope changes according to the changes of the waveforms displayed). Pressing this knob will clear the channel offset to zero. (Exclude digital channels in the Mixed Signal Oscilloscope)

1. Using vertical SCALE knob.

The vertical  SCALE can change the vertical sensitivity of waveforms in all channels (including MATH and REF, excluding LA). If the Volts/Div is set to "Coarse", the waveform scales in a 1-2-5 step sequence from 2 mV to 5 V. If the Volts/Div is set to "Fine", it scales to small steps between the coarse settings.

3. Channels can be adjusted by the vertical POSITION and SCALE only when they are selected.

4. When you change the vertical position, the position message is displayed on the left bottom of the screen, in the same color as the corresponding channel. The unit is V (Volts).

Understand the Horizontal System

The oscilloscope shows the time per division in the scale readout. Since all active waveforms use the same time base, the oscilloscope only displays one value for all the active channels, except when you use Delayed Scan, or Alternative Trigger.

The horizontal controls can change the horizontal scale and position of waveforms. The horizontal center of the screen is the time reference for waveforms. Changing the horizontal scale causes the waveform to expand or contract about the screen center.

Horizontal position changes the displayed waveform position, relative to the trigger point.

The Horizontal Knobs

POSITION: The horizontal **POSITION** knob adjusts the horizontal position of all channel (include Math) waveforms. The resolution of this control varies with the time base. Pressing this button clears trigger offset and moves the trigger point to the horizontal center of the screen.

SCALE: Use **SCALE** to select the horizontal time/div (scale factor) for the main or the Delayed Scan time base. When Delayed Scan is enabled, it changes the width of the window zone by changing the Delayed Scan time base.

Horizontal Menu.

Press the horizontal **MENU** button to display the horizontal menu. The settings of this menu are listed in the following table.

Figure 2-37 Table 2-19



Menu	Settings	Comments
Delayed	ON	Turn on Delayed Scan mode
	OFF	Turn off the Delayed Scan mode
Time Base	Y-T	Show the relative relation between vertical voltage and horizontal time.
	X-Y	Show CH1 value at X axis; CH2 value at Y axis.
	Roll	In Roll Mode, the waveform display updates from right to left.
Trig-offset Reset		Adjust to the center

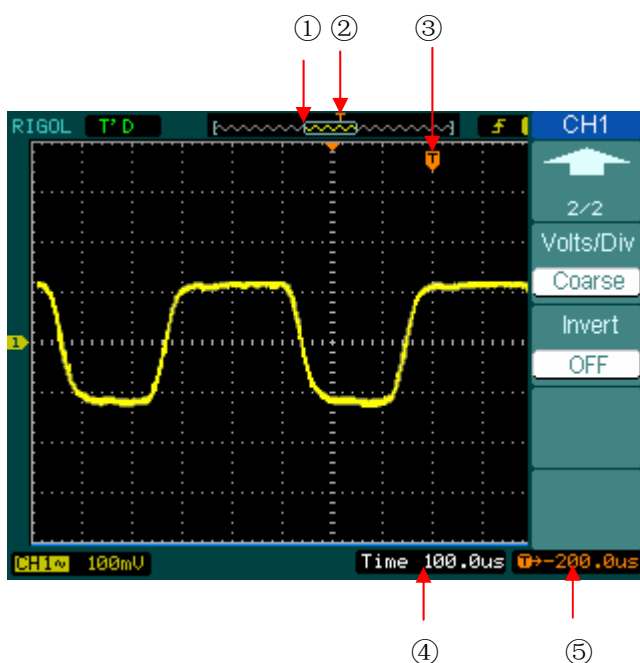

Figure 2-38: Status bar and mark for Horizontal control

Marks Indicator

- ① The mark represents the current waveform window's position in the memory.
- ② This mark displays the trigger position in the memory.
- ③ This mark displays the trigger position in the current waveform windows.
- ④ Status bar displays the horizontal time base (main time base).
- ⑤ Status bar displays the trigger's horizontal offset according to the center of the window.

Key Points

Y-T: The conventional oscilloscope display format. It shows the voltage of a waveform record (on the vertical axis) as it varies over time (on the horizontal axis).

X-Y: XY format displays channel 1 in the horizontal axis and channel 2 in the vertical axis.

Roll Mode: In this mode, the waveform display rolls from right to left. No trigger or horizontal offset control of waveforms is available during Roll Mode, and it's only available when set to 500 ms/div or slower.

Slow Scan Mode: This mode is available when the horizontal time base is set to 50ms or slower. In this mode, the oscilloscope acquires sufficient data for the left part to the trigger point, then wait for trigger, when trigger occurs, it continue to draw the rest part from the trigger point to the end of the right side. When choosing this mode to view low frequency signals, it is recommended that the channel coupling be set as **DC**.

Time/Div: Horizontal scale. If the waveform acquisition is stopped (using the **RUN/STOP** button), the Time/Div control expands or compresses the waveform.

Delayed Scan:

The Delayed Scan is a magnified portion of the main waveform window. You can use Delayed Scan to locate and horizontally expand part of the main waveform window for a more detailed (higher horizontal resolution) analysis of signal. Use Delayed Scan to expand a segment of a waveform to see more details. The Delayed Scan time base setting cannot be set slower than the Main time base setting.

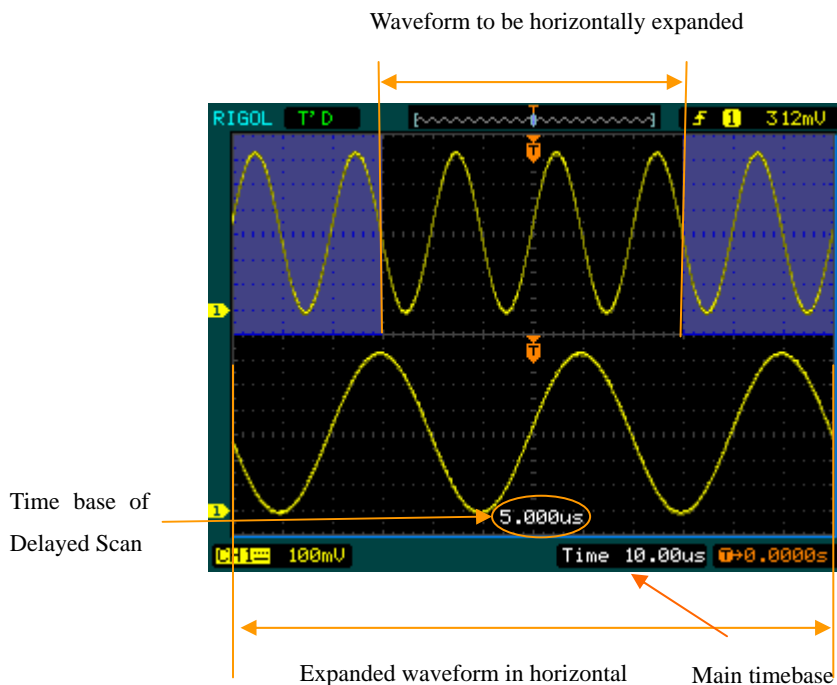





Figure 2-39: Delayed Scan window

The following steps show you how to use Delayed Scan.

1. Connect a signal to the oscilloscope and obtain a stable display.
2. Press horizontal **MENU** → **Delayed** → **ON** or press horizontal **SCALE** knob to enter Delayed Scan mode.

The screen is divided into two parts. The upper half displays the main waveform window and the lower half displays an expanded portion of the main waveform window. This expanded portion of the main window is called the Delayed Scan

window. Two blocks shadow the upper half; the un-shadowed portion is expanded in the lower half. The horizontal  POSITION and  SCALE knobs control the size and position of the Delayed Scan. The symbol at bottom of the screen means the main time base and the symbol on the center bottom means the Delayed Scan time.

- Use the horizontal  POSITION knob to change the position of the expanded portion.
- Turn the horizontal  SCALE knob to adjust the Delayed Scan resolution.
- To change the main time base, you must turn off the Delayed Scan mode.
- Since both the main and Delayed Scan are displayed; there are half as many vertical divisions so the vertical scaling is doubled. Notice the changes in the status bar.

Delayed Scan Shortcut Key:

Delayed Scan function can be activated not only by menu but also by pressing horizontal  SCALE knob.

X-Y Format

This format is useful for studying phase relationships between two signals.

Channel 1 in the horizontal axis(X) and channel 2 in the vertical axis(Y), the oscilloscope uses a none-trigger acquisition mode, data is displayed as dots. .

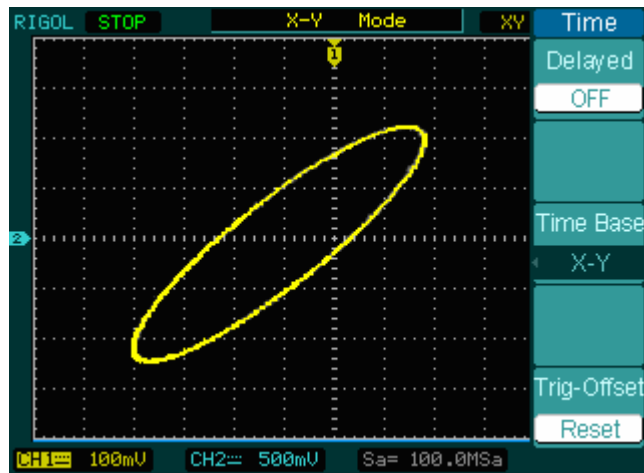



Figure 2-40: X-Y display format

The following modes or functions will not work in X-Y format.

- LA Function (Mixed Signal Oscilloscope)
- Automatic Measurements
- Cursor Measurements
- REF and MATH Operations
- Delayed Scan Mode
- Vector Display Mode
- Horizontal  POSITION knob
- Trigger Controls

Understand the Trigger System

The trigger determines when the oscilloscope starts to acquire data and display a waveform. When a trigger is set up properly, it can convert unstable displays or blank screens into meaningful waveforms.

When the oscilloscope starts to acquire a waveform, it collects enough data so that it can draw the waveform to the left of the trigger point. The oscilloscope continues to acquire data while waiting for the trigger condition to occur. After it detects a trigger, the oscilloscope continues to acquire enough data so that it can draw the waveform to the right of the trigger point.

The trigger control area on the front panel includes a knob and three buttons:

LEVEL: The knob that set the trigger level; press the knob and the level will be cleaned to zero.

50%: The instant execute button setting the trigger level to the vertical midpoint between the peaks of the trigger signal

FORCE: Force to create a trigger signal and the function is mainly used in Normal and Single mode

MENU: The button that activates the trigger controls menu.

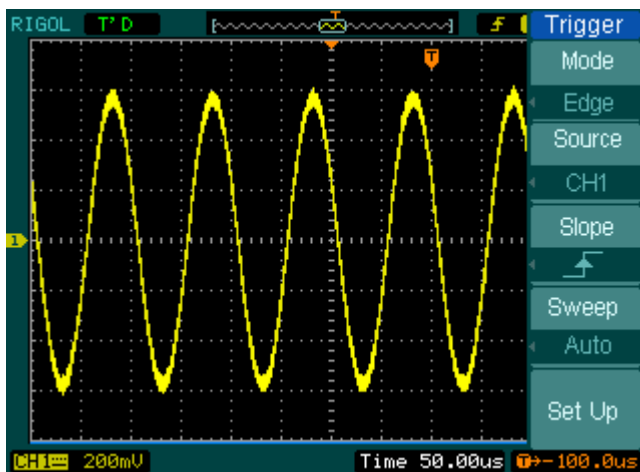

Figure 2-41: Trigger controls

Trigger Modes

The oscilloscope provides seven trigger modes: Edge, Pulse, Slope, Video, Alternative, Pattern (only for mixed signal oscilloscopes) and Duration trigger (only for mixed signal oscilloscopes).

Edge: An edge trigger occurs when the trigger input passes through a specified voltage level in the specified slope direction.

Pulse: Use this trigger type to catch pulses with certain pulse width.

Video: Use video trigger on fields or lines for standard video signals.

Slope: The oscilloscope begins to trigger according to the signal rising or falling speed.

Alternative: Trigger on non-synchronized signals

Pattern: To Trigger through detecting a specified code.



Duration: To trigger within a specified time on the conditions of a specified code

Settings for Edge Trigger

An edge trigger determines whether the oscilloscope finds the trigger point on the rising or the falling edge of a signal. Select Edge trigger Mode to trigger on Rising edge, falling edge or rising & falling edge.

Figure 2-42 Table 2-20



Menu	Settings	Comments
Source	CH1 CH2 EXT EXT/5 AC Line D15-D0	Select CH1 as trigger signal Select CH2 as trigger signal Select EXT TRIG as trigger signal Select attenuated EXT TRIG/5 as trigger signal Select power line as trigger signal Select a digital channel in D15-D0 as trigger source(Only in mixed signal oscilloscopes)
Slope	 Rising  Falling  Rising & Falling	Trigger on rising edge Trigger on falling edge Trigger on both ring & falling edge
Sweep	Auto Normal Single	Acquire waveform even no trigger occurred Acquire waveform when trigger occurred. When trigger occurs, acquire one waveform then stop
Set up		To go to Set Up menu, see table 2-38

Settings for Pulse Width Trigger

Pulse trigger occurs according to the width of pulse. The abnormal signals can be detected through setting up the pulse width condition.

Figure 2-43 Table 2-21









Menu	Settings	Comments
Source	CH1 CH2 EXT EXT/5 D15-D0	Selects CH1 as trigger signal Select CH2 as trigger signal Select EXT TRIG as trigger signal Select attenuated EXT TRIG/5 as trigger signal Select a digital channel in D15-D0 as trigger source(Only in mixed signal oscilloscopes)
When	 (+Pulse width less than)  (+Pulse width more than)  (+Pulse width equal to)  (-Pulse width less than)  (-Pulse width more than)  (-Pulse width equal to)	To select pulse condition
Settings	 <Width>	Set required pulse width

Figure 2-44 Table 2-22



Menu	Settings	Comments
Sweep	Auto	Acquire waveform even no trigger occurred
	Normal Single	Acquire waveform when trigger occurred. When trigger occurs, acquire one waveform and then stop
Set Up		To go to Set Up menu, see table 2-38

Note: The Pulse width adjust range is 20ns ~ 10s. When the condition is met, it will trigger and acquire the waveform.

Settings for Video Trigger

Choose video trigger to trigger on fields or lines of NTSC, PAL, or SECAM standard video signals. Trigger coupling preset to DC.

Figure 2-45 Table 2-23 (Page One)





Menu	Settings	Comments
Source	CH1	Selects CH1 as trigger source
	CH2	Select CH2 as trigger source
	EXT	Select EXT TRIG as trigger source
	EXT/5	Select EXT TRIG/5 as trigger source
Polarity	 Normal polarity	Triggers on negative going sync pulses
	 Inverted polarity	Triggers on positive going sync pulses
Sync	All Lines	Trigger on all lines
	Line Num	Trigger on an specified line
	Odd field	Select to trigger on odd field
	Even field	Select to trigger on even field

Figure 2-46 Table 2-24 (Page Two, when Sync is set as the specified line)



Menu	Settings	Comments
Line Num	 < Line sync >	Select the specified line number for sync
Standard	PAL/SECM NTSC	Select Video standard
Set Up		To go to set up menu, see table 2-39

Figure 2-47 Table 2-25 (when the Sync is set as All lines, Odd field and Even field)



Menu	Settings	Comments
Standard	PAL/SECAM NTSC	Select Video standard
Set Up		To go to set up menu, see table 2-39

Key points

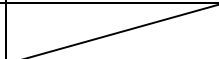
Sync Pulses: When Normal Polarity is selected, the trigger always occurs on negative-going sync pulses. If the video signal has positive-going sync pulses, use the inverted Polarity selection.

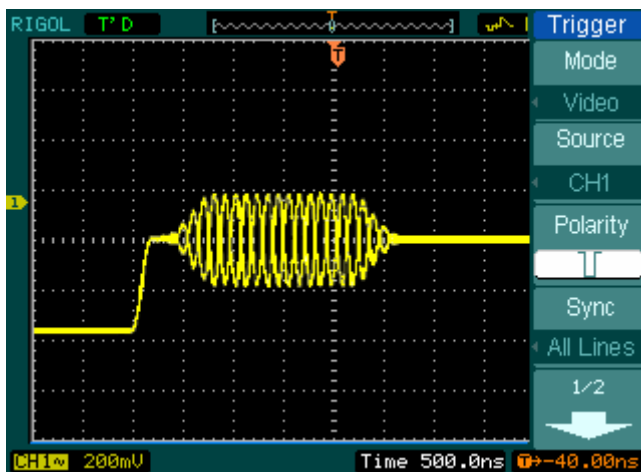

Figure 2-48: Line Synchronization

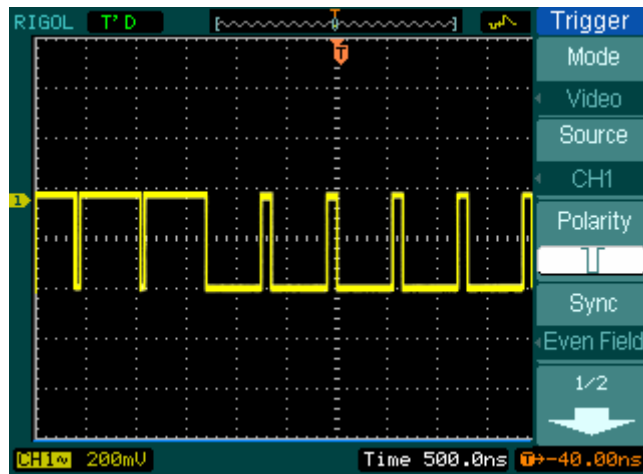

Figure 2-49: Video Trigger: Field Synchronization

SLOPE TRIGGER

Slope trigger sets the oscilloscope as the positive/negative slope trigger within the specified time

Figure 2-50 Table 2—26 (Page One)

Trigger	Mode	Slope	Source	CH1	When	Time	1.00us	1/2
Trigger	Mode	Slope	Source	CH1	When	Time	1.00us	1/2
	Menu	Settings	Comments					
	Source	CH1 CH2 EXT EXT/5	Set channel 1 as trigger source Set channel 2 as trigger source Set EXT. channel as trigger source Set EXT/5 as trigger source					
	When		Set slope condition					
	Time	 <Time Set >	Set slope time					

Figure 2-51 Table 2—27 (Page Two)

Trigger	2/2	Vertical	Sweep	Auto	Set Up
Trigger	2/2	Vertical	Sweep	Auto	Set Up
	Menu	Settings	Comments		
	Vertical		Select the level that can be adjusted by LEVEL		
	Sweep	Auto Normal Single	Acquire waveform even when no trigger condition is met. Acquire waveform when trigger condition is met. When trigger condition is met, acquire one waveform and then stop		
	Set Up	/	To go to set up menu. See table 2-38		

Note: Slope time can be set from 20ns to 10s. When a signal meets the trigger condition, scope will execute the acquisition. You can adjust LEVEL A/ LEVEL B or both simultaneous by turning the LEVEL knob.

Alternative Trigger

When alternative trigger is on, the trigger sources are from two vertical channels. This mode can be used to observe two non-related signals. You can choose two different trigger modes for the two vertical channels. The options are as follows: Edge, Pulse, Slope and video. The info of the trigger level of the two channels will be displayed on the upper-right of the screen.

Figure 2-52 Table 2—28 (Trigger Type: Edge)



Menu	Settings	Comments
Select	CH1 CH2	Set trigger mode for Channel 1 Set trigger mode for Channel 2
Type	Edge	Set Edge Trigger as the trigger type
Slope	↗ (Rising) ↘ (Falling) ↑↓ (Rising & Falling)	Trigger on rising edge Trigger on falling edge Trigger on both ring & falling edge
Set Up		To go to set up menu. See table 2-38

Figure 2-53 Table 2–29 (Trigger Type: Pulse Page One)







	Menu	Settings	Comments
	Select	CH1 CH2	Set trigger mode for Channel 1 Set trigger mode for Channel 2
	Type	Pulse	Set Pulse Trigger for the channel
When	 (+Pulse width less than)  (+Pulse width more than)  (+Pulse width equal to)  (-Pulse width less than)  (-Pulse width more than)  (-Pulse width equal to)	To select pulse condition	

Figure 2-54 Table 2–30 (Trigger Type: Pulse Page Two)



	Menu	Settings	Comments
	Setting	 <pulse width>	Set the width of the pulse
	Set Up	/	To go to set up menu. See table 2-38

Figure 2-55 Table 2—31 (Trigger Type: Slope Page One)



Menu	Settings	Comments
Select	CH1 CH2	Set trigger mode for Channel 1 Set trigger mode for Channel 2
Type	Slope	Set Slope Trigger for the vertical channel
When		Set trigger condition

Figure 2-56 Table 2—32 (Trigger Type: Slope Page Two)



Menu	Settings	Comments
Time	 <Time Set >	Set slope time
Vertical		Select the level to be adjusted by <u>LEVEL</u>
Set Up		To go to set up menu. See table 2-38

Figure 2-57 Table 2—33 (Trigger Type: Video Page One)







Menu	Settings	Comments
Select	CH1 CH2	Set trigger mode for Channel 1 Set trigger mode for Channel 2
Type	Video	Video Trigger for the channel
Polarity	 Normal polarity  Inverted polarity	Triggers on negative going sync pulses Triggers on positive going sync pulses

Figure 2-58 Table 2—34 (Trigger Mode: Video Page two)

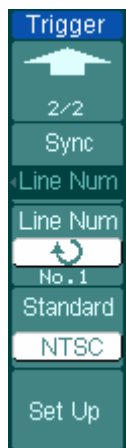

Menu	Settings	Comments
Sync	ALL lines	Trigger on all lines
	Line Num	Trigger on an specified line
Line Num	Odd field	Select to trigger on odd field or even field
	Even field	
Line Num	 <Lines Set >	Select the specified line number for sync
Standard	PAL/SECM NTSC	Select Video standard
Set Up		To go to set up menu, see table 2-39

Pattern Trigger (Mixed Signal Oscilloscope)

Pattern trigger identifies trigger terms by checking appointed code. The code is logical relationship of all channels, with high (H), low (L) and ignore(X).

Figure 2-59 Table 2-35

	Menu	Settings	Comments
	Select	D15-D0	Choose digital channel for Pattern trigger
	Code	H L X 	High Low Ignore Rising Edge Falling Edge
	Sweep	Auto Normal Single	Acquire waveform even no trigger occurred Acquire waveform when trigger occurred When trigger occurs, acquire one waveform and then stop
	Set Up		To go to set up menu, see table 2-40

Key Points:

H (High): Logic high: voltage is higher than threshold setting.

L (Low): Logic low: voltage is lower than threshold setting.

X (Ignore): Don't care. If all the channels are ignored, the oscilloscope won't be triggered.

Rising Edge () or Falling Edge (): Set the code as an edge of the channel, rising edge or falling edge. When the edge is appointed, if code settings of other channels are all true, the oscilloscope will be triggered on the appointed edge. If no edge is appointed, the oscilloscope will be triggered on the last edge whose code is true.

Edge of appointed code

You can only appoint one code as edge. If you have appointed an edge, then appointed another edge in a different channel, and the first appointed edge will be set to X (Ignore).

Duration Trigger (Mixed Signal Oscilloscope)

Trigger in appointed time when code terms are satisfied.

Figure 2-60 Table 2-36 (Page One)



Menu	Settings	Comments
Select	D15-D0	Choose digital channel for Duration Trigger
Code	H L X	High Low Ignore
Qualifier	< > =	Set time limit terms

Figure 2-61 Table 2-37 (Page Two)



Menu	Settings	Comments
Time	 <Time Setting >	Set duration and limit symbol time
Sweep	Auto Normal Single	Acquire waveform even no trigger occurred Acquire waveform when trigger occurred When trigger occurs, acquire one waveform and then stop
Set Up		To go to set up menu, see table 2-40

Key Points:

H (High): Logic high: voltage is higher than threshold setting.

L (Low): Logic low: voltage is lower than threshold setting.

X (Ignore): Don't care. If all the channels are ignored, the oscilloscope won't be triggered.

Qualifier: A timer begins when code terms are satisfied. Duration trigger occurred in the time set by the qualifier.

Trigger Settings

In trigger set up menu, you can set up different trigger settings according to different trigger modes. When in the mode of Edge and Pulse, the source is D15-D0 (Mixed Signal Oscilloscope), only Holdoff is adjustable. When source is non-digital channel and in slope trigger, only trigger coupling, trigger sensitivity and Holdoff can be set. For video trigger, Sensitivity and Holdoff can be set. For Pattern trigger and Duration trigger (Mixed Signal Oscilloscope), only Holdoff can be set. When in Alternative trigger, you can make different settings according to selected different trigger modes.

Figure 2-62 Table 2-38 (Settings for trigger coupling, trigger sensitivity and holdoff)



	Menu	Settings	Comments
	Coupling	DC AC HF Reject LF Reject	Allow all signals pass Block DC signals Reject high frequency signals Reject DC and low frequency signals
	Sensitivity	 <Sensitivity Setting>	Set trigger sensitivity
	Holdoff	 <Holdoff Setting>	Set time slot before another trigger event
	Holdoff Reset	/	Reset Holdoff time to 100ns

Figure 2-63 Table 2-39 (Settings for sensitivity and holdoff)



Menu	Settings	Comments
Sensitivity	 <Sensitivity Setting>	Set trigger sensitivity
Holdoff	 <Holdoff Setting>	Set time slot before another trigger event
Holdoff Reset		Reset Holdoff time to 100ns

Figure 2-64 Table 2-40 (Settings only for holdoff)



Menu	Settings	Comments
Holdoff	 <Holdoff Setting>	Set time slot before another trigger event
Holdoff Reset		Reset Holdoff time to 100ns

Trigger Holdoff

Trigger Holdoff can stabilize complex waveform, such as the pulse range. Holdoff time is the oscilloscope's waiting period before starting a new trigger. During Holdoff, oscilloscope will not trigger until Holdoff ends. For instance: To trigger on the first pulse on a group of them, users can set the holdoff time to Pulse cluster width.

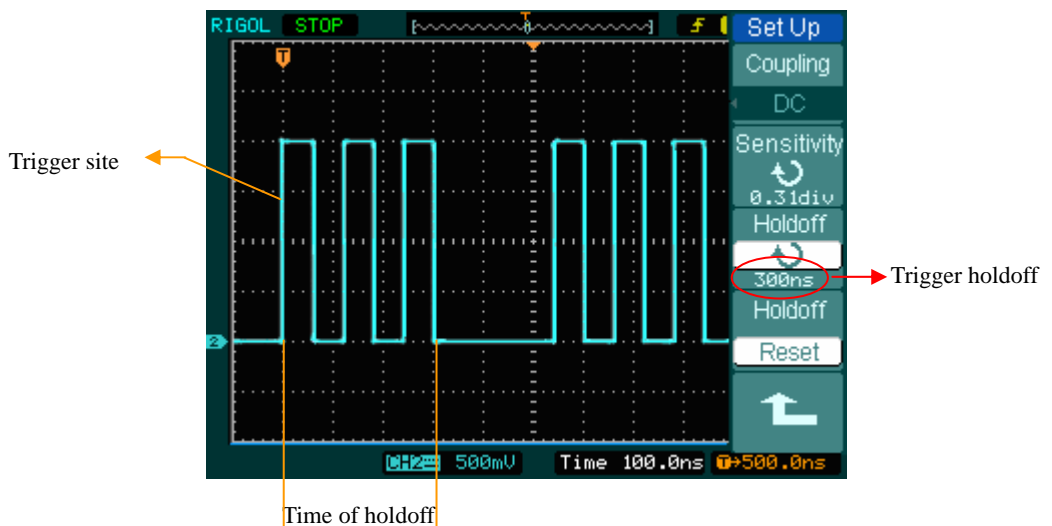

Figure 2-65: Trigger Holdoff

To use trigger Holdoff:

1. Press the trigger **MENU** button to display Trigger Menu.
2. Press **Set Up** key to display trigger set up menu.
3. Turn the multi function knob (↻) to change Holdoff time until waveform is stable.
4. Pushing Trigger **Hold off reset** can reset the Holdoff time to its default value.

Trigger Key points

1. Trigger Source:

Trigger can occur from several sources: Input channels (CH1, CH2 and D15-D0 on mixed signal oscilloscopes), AC Line, Ext, Ext/5.

- **CH1 or CH2:** It is the most commonly used trigger source. The channel will work when selected as a trigger source whatever displayed or not.
- **Ext Trig:** The instrument can trigger from a third source while acquiring data from CH1 and CH2. For example, you might want to trigger from an external clock or with a signal from another part of the test circuit. The Ext, Ext/5 trigger sources use the external trigger signal connected to the EXT TRIG connector. Ext uses the signal directly; it has a trigger level range of +1.6 V to -1.6 V. The EXT/5 trigger source attenuates the signal by 5X, which extends the trigger level range to +8 V to -8 V. This allows the oscilloscope to trigger on a larger signal.
- **AC Line:** AC power can be used to display signals related to the power line frequency, such as lighting equipment and power supply devices. The oscilloscope gets triggered on its power cord, so you do not have to input an AC trigger signal. When AC Line is selected as trigger source, the oscilloscope automatically set coupling to DC, set trigger level to 0V.

2. Sweep Mode:

The sweep mode determines how the oscilloscope behaves in the absence of a trigger event. The oscilloscope provides three trigger modes: Auto, Normal, and Single.

- **Auto:** This sweep mode allows the oscilloscope to acquire waveforms even when it does not detect a trigger condition. If no trigger condition occurs while the oscilloscope is waiting for a specific period (as determined by the time-base setting), it will force itself to trigger.

When forcing invalid triggers, the oscilloscope cannot synchronize the waveform, and the waveform seems to roll across the display. If valid triggers occur, the display becomes stable on the screen.

Any factor results in the un-stability of waveforms can be detected by Auto

Trigger, such as the output of Power supply.

NOTE: When horizontal control is set under 50 ms/div, Auto mode allows the oscilloscope don't capture trigger signal.

- **Normal:** The Normal mode allows the oscilloscope to acquire a waveform only when it is triggered. If no trigger occurs, the oscilloscope keeps waiting, and the previous waveform, if any, will remain on the display.
- **Single:** In Single mode, after pressing the RUN/STOP key, the oscilloscope waits for trigger. While the trigger occurs, the oscilloscope acquires one waveform then stop.

3. Coupling:

Trigger coupling determines what part of the signal passes to the trigger circuit. Coupling types include AC, DC, LF Reject and HF Reject.

- **AC:** AC coupling blocks DC components.
- **DC:** DC coupling passes both AC and DC components.
- **LF Reject:** LF Reject coupling blocks DC component, and attenuates all signal with a frequency lower than 8 kHz.
- **HF Reject:** HF Reject coupling attenuates all signals with a frequency higher than 150 kHz.

4. Pre-trigger/delayed trigger:

The data collected before and after trigger.

The trigger position is typically set at the horizontal center of the screen. In the full-screen display the 6div data of pre-trigger and delayed trigger can be surveyed. More data (14div) of pre-trigger and 1s delayed trigger can be surveyed by adjusting the horizontal  POSITION knob.

This feature is very useful because you can see the events that led up to the trigger point. Everything to the right of the trigger point is called post-trigger information. The amount of delay range (pre-trigger and post-trigger information) available is dependent on the sweep speed selected.

5. Adjustable trigger sensitivity

To avoid the influence of noise from the physical world, and get the stable trigger, the trigger circuit has adopted Stickiness. In DS1000 series, the stickiness is adjustable from 0.1div-1.0div, which means when it sets to 1.0div, the trigger circuit will not affect any signal with peak-peak amplitude less than 1.0div, so as to avoid the influence of the noise.

To Set Up the Sampling System

As Figure 2-66 displays, the **Acquire** button for sampling system is at the MENU

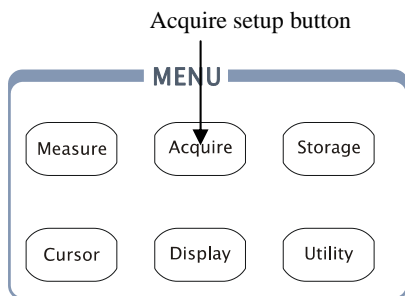

Figure 2-66

Use **Acquire** button to pop up the menu as follows:

Figure 2-67



Table 2-41

Menu	Settings	Comments
Acquisition	Normal	Normal Acquisition mode
	Average	Average Acquisition mode
	Peak Detect	Peak Detect Acquisition mode
Averages	2 to 256	Step by multiple of two. Set average times from 2 to 256
Sampling	Real-Time	Real-time sampling mode
	Equ-Time	Equivalent sampling mode
Mem Depth	Long Mem	Set up memory as 512K or 1M
	Normal	Set up memory as 1K or 2K
Sa Rate	100.0MSa	Display sampling rate

The waveform displayed on the screen will change in conjunction with the setting of Acquire menu.

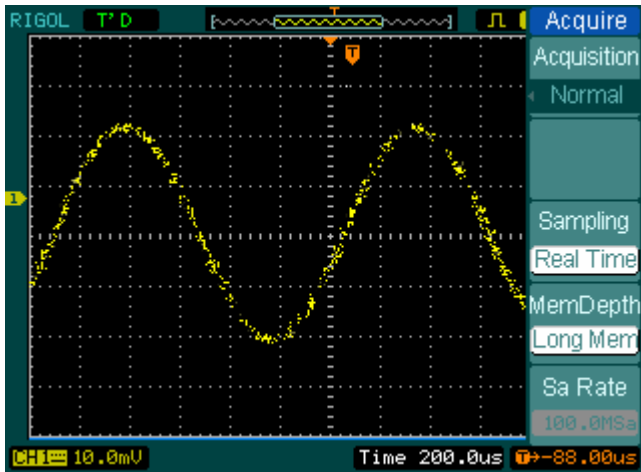

Figure 2-68: Signal that contains noise, and without average sampling

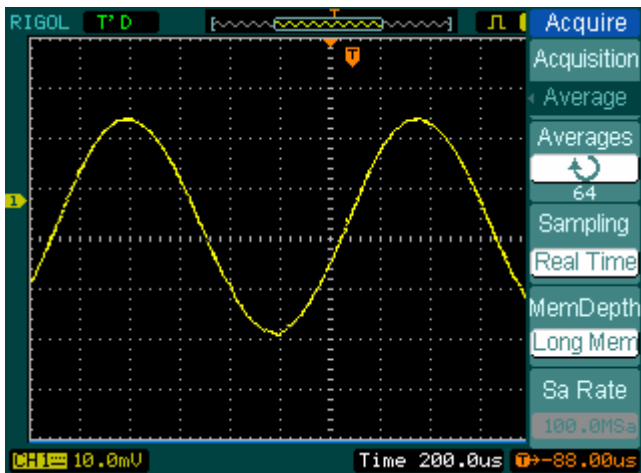

Figure 2-69: Display signal after average sampling

Note:

- Select **Real-time** acquisition to observe the single-shot or pulse signals.
- Select **Equ-Time** to observe high frequency repetitive signals.

- To reduce the displayed random noise, select the **Average** Acquisition. And this mode would make the screen refresh slower.
- To Avoid signal aliasing, select **Peak Detect** Acquisition.

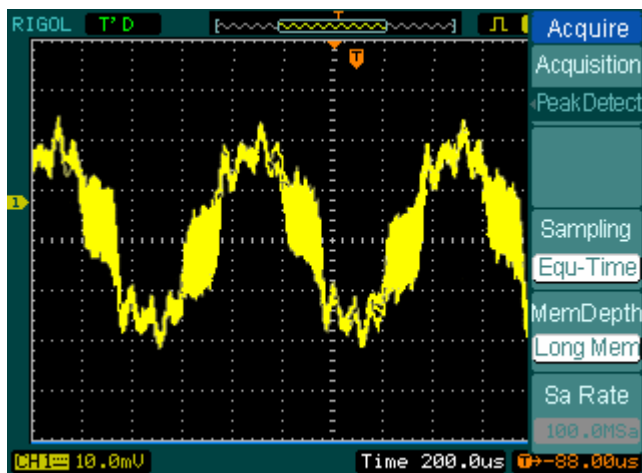

Figure 2-70: Signal with Peak Detect Acquisition

The Peak Detect effect is shown as the figure above.

Stop Acquisition: When the scope is acquiring waveforms, the waveforms is in a live status; when acquisition is stopped, frozen waveform will be displayed, the position and scale can still be adjusted by vertical control and horizontal control.

Key Points**Real-time Sampling:**

DS1000 has Real-time sampling rate up to 400MSa/s. At the time base 50ns or faster, the oscilloscopes use the sine(x)/x interpolation to expand the horizontal time base.

Equivalent sampling:

Also known as Repetitive sampling. In this mode, you can get up to 40 ps of horizontal resolution (equivalent 25Gsa/s). This mode is good for observing repetitive signals, and it is not recommended for single-shot or pulse.

Normal:

Oscilloscope acquires signal by equal time interval.

Average Acquisition:

Apply averaging to your signal to remove uncorrelated noise and improve measurement accuracy. Reduces random or uncorrelated noise in the signal display. The averaged waveform is a running average over a specified number of acquisitions from 2 to 256.

Peak Detect:

Peak Detect mode captures the maximum and minimum values of a signal. Finds highest and lowest record points over many acquisitions.

To Set Up the Display System

Figure 2-71 shows the menu button for the display system on the front panel.

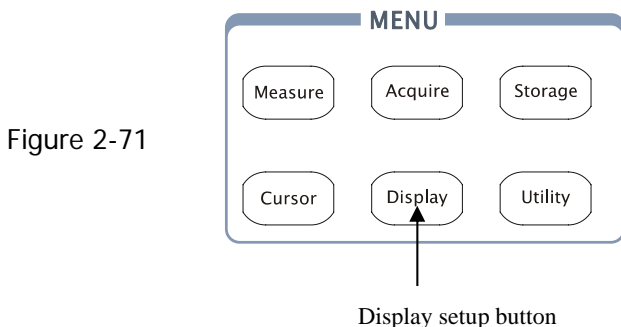

Press the **Display** button to pop up the menu for the settings of the display system.

Figure 2-72

Table 2-42







Menu	Setting	Comments
Type	Vectors Dots	Display waveforms as vectors Display waveforms as dots
Clear		Clear all existing waveforms from screen
persist	Infinite	The sample points remain displayed until turn the persistence "OFF".
	OFF	Turn off the persistence function
Intensity	 <percentage >	Set up waveform intensity

Figure 2-73 Table 2-43



Menu	Settings	Comments
Grid	  	Display grids and coordinates on the screen Turn off the grids Turn off the grids and coordinates
Brightness	 < percentage >	Set up grid brightness
Menu Display	1s 2s 5s 10s 20s Infinite	Set the time before menu fades away. The menu will be hidden after the set time of last button pressing.
Screen	Normal Invert	Set to normal mode Set to invert color display mode

Key points:

Display type: Display type includes Vector and Dot. In vectors type, oscilloscope connects dots through digital interpolation including both linearity and $\sin(x)/x$. $\sin(x)/x$ interpolation is suitable for Real-time sampling and will be more effective at 50ns or faster time base.

Refresh rate: It is an important performance of digital oscilloscopes. It means times of oscilloscopes' refreshing per second and will affect the ability to observe signal.

Adjusting waveform intensity

Default setup of multi-function knob () is adjusting waveform intensity.

To Store and Recall Waveforms or Setups

Figure 2-74 shows the menu button for the storage system on the front panel.

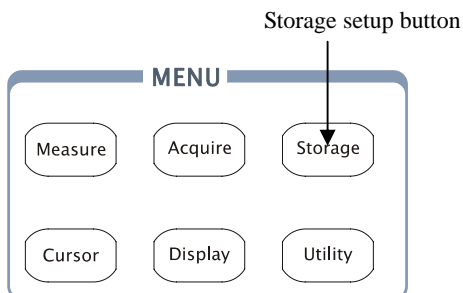

Figure 2-74

Press the **Storage** button to pop up the menu for the settings of the storage system. The waveforms and setups in both internal memory and external memory can be stored and recalled. The waveform file, setup file, bitmap and CSV file in external memory can be created and deleted. System supports English/Chinese key in.

Waveform and setup, the menu as following:

Figure 2-75 Table 2-44



Menu	Settings	Comments
Storage	Waveform	Store or recall waveform
	Setups	Store or recall instrument setups
	Bit map	Create or delete bit map files
	CSV	Create or delete CSV files
	Factory	Recall factory setups
Internal		Go to menu for internal memory operation(see table 2-48)
External		Go to menu for external memory operation(see table 2-49)
Disk Mana.		Go to disk manage menu (see table 2-50)

For factory default setups, the menu as following:

Figure 2-76 Table 2—45



Menu	Settings	Comments
Storage	Waveform Setups Bit map CSV Factory	Store or recall waveform Store or recall instrument setups Create or delete bit map files Create or delete CSV files Recall factory setups
Load		Recall factory setups or files
Disk Mana.		Go to disk manage menu (see table 2-50)

For CSV, the menu as following:

Figure 2-77 Table 2—46



Menu	Settings	Comments
Storage	Waveform Setups Bitmap CSV Factory	Store or recall waveform Store or recall setups Create or delete bit map files Create or delete CSV files Recall factory setups
Data Depth	Displayed Maximum	Save currently displayed waveform data to CSV file Save the whole waveform data in memory to CSV file
Para Save	On Off	Save the current oscilloscope settings in different format with the same file name
External		Go to menu for external memory operation(see table 2-49)
Disk Mana.		Go to disk manage menu (see table 2-50)

For bitmap, the menu is as follows.

Figure 2-78

Table 2—47



Menu	Settings	Comments
Storage	Waveform Setups Bit map CSV Factory	Store or recall waveform Store or recall setups Create or delete bit map files Create or delete CSV files Recall factory setups
Para Save	On Off	Save the current oscilloscope settings in different format with the same file name
External		Go to menu for external memory operation(see table 2-49)
Disk Mana.		Go to disk manage menu (see table 2-50)

Internal Memory

Press **Storage** → **Internal** to go to the following menu.

Figure 2-79 Table 2-48



Menu	Settings	Comments
Internal	Int_00 (N) . . . Int_09 (N)	Set up the location of files in internal memory
Load		Recall waveform files and setup files from the internal memory location
Save		Save waveform files and setup files to the internal memory location

External Memory

Press **Storage** → **External** to go to the following menu.

Figure 2-80 Table 2-49

Menu	Settings	Comments
Explorer	Path Directory File	Switch among Path, Directory and File
New File (Folder)		To create new file or folder.
Delete File(Folder)		Delete file(Folder)
Load		Recall waveform and setup from USB storage device.

File system as follows:

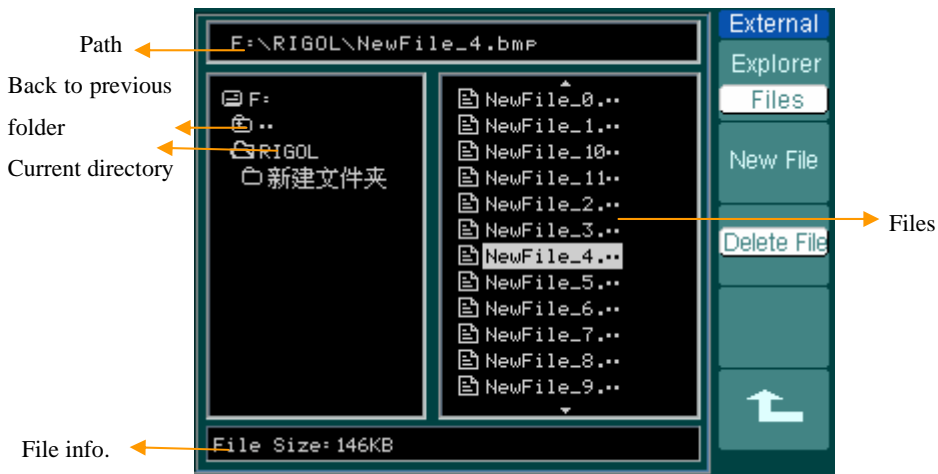

Figure 2-81

Disk Manage

Press **Storage** → **Disk Mana.** to go to the following menu.

Figure 2-82 Table 2-50



Menu	Settings	Comments
Explorer	Path Directory File	Switch among Path, Directory and File
New folder		To create new folder(same as new files, see table 2-13)
Delete File		Delete file
Load		Recall waveform, setup, recorded waveform, Pass/Fail file

Figure 2-83 Table 2-51



Menu	Settings	Comments
Rename		To rename a file (see table 2-52)
Disk info		Display disk information

Rename

Press **Storage** → **Disk Mana.** → **Rename** to go to the following menu.

Figure 2-84

Table 2-52



Menu	Settings	Comments
↑		To move the cursor up
↓		To move the cursor down
X		To delete chosen letter
OK		Rename the file

Rename system as following:

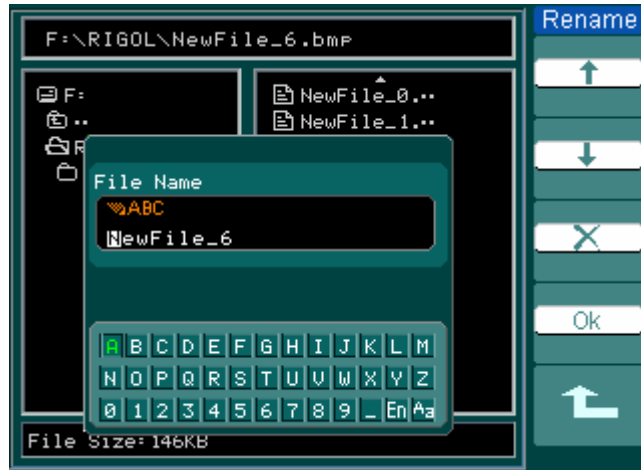

Figure 2-85

Factory

The oscilloscope has default settings and can be recalled at anytime by user.

Memory location

Specify the memory location to save/recall the waveform and setup.

Load

Recall saved waveform, setup and default settings.

Save

Save waveform and setups.

NOTE:

1. Select **Save** stores not only the waveforms, but also the current settings of the oscilloscope
2. Only after the settings are changed for more than 5 seconds can the user turn off the instrument. This ensures the setup be saved properly. The oscilloscope can store 10 settings permanently and can restore at anytime.

To Set Up the Utility

Figure 2-86 shows the menu button for the Utility on the front panel.

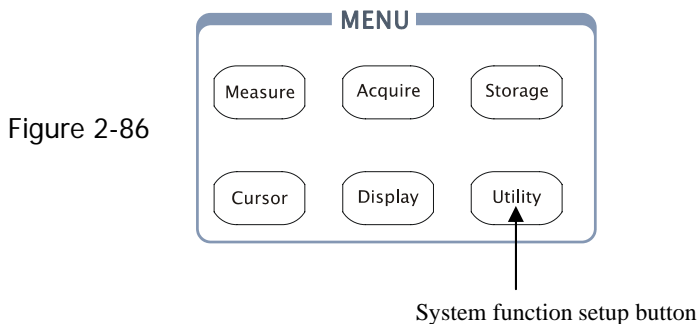

Press the **Utility** button to pop up the menu for the settings of the Utility system.

Figure 2-87 Table 2-53



Menu	Setting	Comments
I/O setting		Setup I/O configuration
Sound	(ON)	Switch beeper sound on/off
	(OFF)	
Counter	OFF	Turn off Frequency Counter
	ON	Turn on Frequency Counter
Language	简体中文 繁体中文 English 日本語 Français	Select languages (More languages may be added in later firmware versions)

Figure 2-88



Table 2-54

Menu	Settings	Comments
Pass/Fail		Setup Pass/Fail test
Record		Setup Waveform Recorder
Print set		Setup printing

Figure 2-89



Table 2-55

Menu	Settings	Comments
Fast-Cal	ON OFF	Turn on fast-calibration Turn off fast-calibration
Self-Cal		Execute Self-calibration
Service		Go to service menu
Preference		Go to preference menu

Note:

Fast-Cal: When turn on the fast-cal function, oscilloscope will calibrate vertical offset several times according to the running time. The Fast-Cal will run immediately when it's turned on.

Self-Cal: Oscilloscope will calibrate parameter of vertical system (CH1, CH2, and Ext), horizontal system and trigger system.

The I/O setup:

Press **Utility** → **I/O setting** to go to the following menu.

Figure 2-90



Table2-56

Menu	Display	Comments
RS-232 Baud	300 . . 38400	Set RS-232 baud rate as 300, 2400, 4800, 9600, 19200 or 38400.

Preference

Press **Utility** → **Preference** to go to the following menu

Figure 2-91

Table 2-57



Menu	Display	Comments
Screen saver	1 min . . 5 hour OFF	Set up screen saver timer
Expand Refer.	Ground Center	Set up waveform vertical expand reference
Sticky key		Set up sticky state of CH1、CH2、Math、Ref、Trig Level and Trig Offset
Skin	Classical Modern Tradition Succinct	Set up skin style

NOTE:

Screen saver: This function can extend the life of LCD backlight tube.

Expand reference: When changing the volts/div. for channels, you can have the signal expand or compress around the signal ground level, or the center of the screen. When **Center** is selected, the waveform will expand or compress around the center of the display. When **Ground** is selected, the channel ground level will remain the same position on the display and waveform will zoom about the ground level.

Sticky key: If sticky feature is turned on, when adjusting positions (CH1, CH2, Math, Ref, Trig level and Trig offset), the object will stop at zero position until next adjustment, for the ease of getting back to initial positions.

Self-Calibration

The Self-Calibration adjusts the oscilloscope's internal circuitry to get the best accuracy. Use these functions to calibrate the oscilloscope's vertical and horizontal systems.

For maximum accuracy at any time, run this calibration if the ambient temperature changes by 5° C or more.

Before running this procedure, do these steps:

1. Disconnect any probes or cables from all channel inputs, otherwise failure or damage to the oscilloscope may occur.
2. Push the **Utility** button and select **Self-Cal**.

The self-calibration menu is displayed as Figure 2-92.

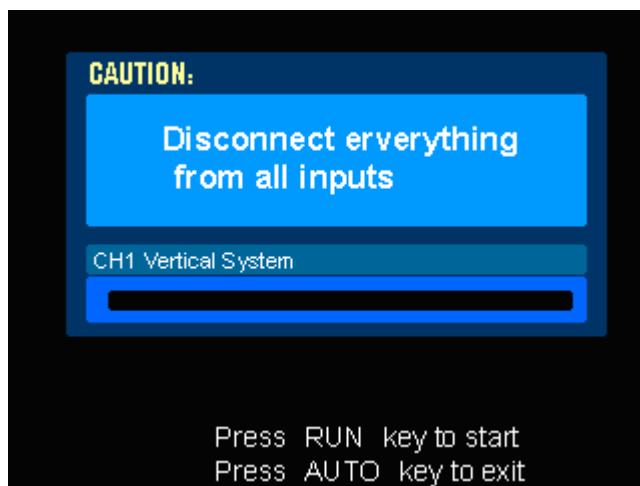

Figure 2-92

NOTE:

The oscilloscope must have been working or warm-up **at least 30-minutes** before running self-calibration to get best accuracy.

Pass/Fail

The pass/fail function can monitor changes of signals and output pass or fail signals by judging the input signal is within the pre-defined mask or not.

Press **Utility** → **Pass/Fail** to go to the following menu.

Figure 2-93 Table 2-58



Menu	Setting	Comments
Enable Test	ON	Turn on Pass/Fail test
	OFF	Turn off Pass/Fail test
Source	CH1	Select Pass/Fail test on CH1
	CH2	Select Pass/Fail test on CH2
Operate	▶ (RUN)	Pass/Fail test stopped, press to run
	■ (STOP)	Pass/Fail test running, press to stop
Msg display	ON	Turn on Pass/Fail information display
	OFF	Turn off Pass/Fail information display

Figure 2-94 Table 2-59



Menu	Settings	Comments
Output	Fail	Output when Fail condition detected
	Fail + 🔊	Output and beep when Fail condition detected
	Pass	Output when Pass condition detected
	Pass + 🔊	Output and beep when Pass condition detected
Stop on Output	ON OFF	Stop test when output occur Continue test when output occur
Mask Setting		Go to mask setting menu

Mask setting

Press **Utility** → **Pass/Fail** → **Mask Setting** to go to the following menu.

Figure 2-95



Table 2-60

Menu	Settings	Comments
X Mask	 < x div >	Set horizontal clearance to the waveform (0.04div-4.00div)
Y Mask	 < y div >	Set vertical clearance to the waveform (0.04div-4.00div)
Create Mask		Create a test mask according to the above clearance
Location	Internal External	Set the memory location of the mask files.

Figure 2-96



Table 2-61 when the save as Internal memory

Menu	Settings	Comments
Save		Store created test mask into internal memory
Load		Recall mask setting file from internal memory
Imp./Exp.		Go to import/export menu (same as REF import/export menu. See table 2-10)

Figure 2-97 Table 2-62 when the save as external memory



Menu	Settings	Comments
Save		Go to save menu (same as REF save menu. See table 2-12)
Load		Go to load menu see table 2-63
Import		Go to import menu. (same as REF import menu see table 2-14)

Load

Press **Utility** → **Pass/Fail** → **Mask Setting** → **Load** to go to the following menu.

Figure 2-98



Table 2-63

Menu	Settings	Comments
Explorer	Path Directory File	Switch among Path, Directory and File
Load		Recall the specified file

NOTE: Pass/Fail function is unavailable in X-Y mode.

Pass/Fail connection

The Pass/Fail connection has an optically isolated output. Users need to connect to another circuit to fulfill the function.

Before connecting external circuit, make sure the maximum voltage/current do not exceed the internal photoMOS relay's rating, 400V/100mA. DS1000 series adopts the technique of Optical Isolation, output device has no polarity and can be used in any circuit within the ratings.

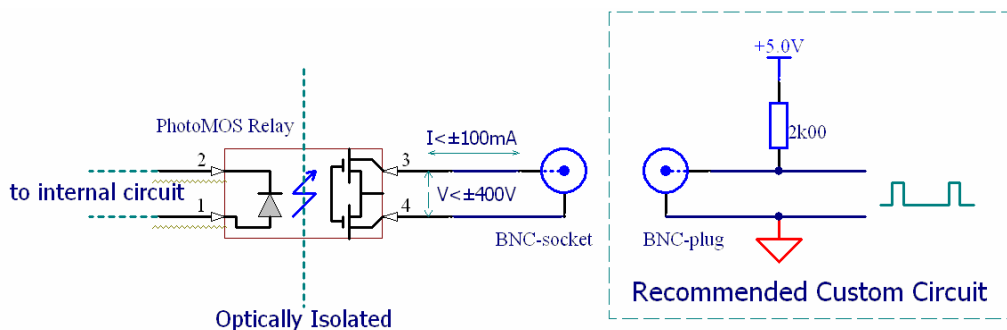

Figure 2-99 Schematic Diagram of Pass/Fail output

Print Set

DS1000 series oscilloscopes support external printers.

Press **Utility** → **Print set** to go to the following menu.

Figure 2-100



Table 2-64

Menu	Settings	Comments
Print		Execute print function
Inverted	ON OFF	invert the color for print print original color
Palette	Gray scale Color	Set up print color

Waveform recorder

Waveform recorder can record input waveform from CH1 and CH2, with a maximum record length of 1000 frames. This record performance can also be activated by the Pass/Fail test output, which makes this function especially useful to capture abnormal signals in long term without keeping an eye watching it.

Press **Utility** → **Record** → **Mode** → **Record** to go to the following menu

Waveform recorder: Record the waveforms with specified interval.

Figure 2-101

Table2-65



Menu	Settings	Comments
Mode	Record Play back Storage OFF	Select record mode Select play back mode Select storage mode Turn off all recorder functions
Source	CH1 CH2 P/F-OUT	Select record source channel
Interval	 <1.00ms-1000s>	Set time interval between record frames
End Frame	 <1-1000>	Set number of record frames
Operate	(Run) (Stop)	Record stopped, press to Start recording Recording, press to stop

Play back: Play back the recorded waveforms.

Figure 2-102 Table 2-66



Menu	Settings	Comments
Operate	▶ (Run)	Play stopped, press to Start playback
	■ (Stop)	Playing, press to stop
Play mode	↺↻	Set repeat play mode
	▶→■	Set single time play mode
Interval	↺ <1.00ms-20s>	Set up interval

Figure 2-103 Table 2-67

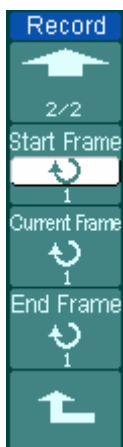

Menu	Settings	Comments
Start Frame	↺ <1-1000>	Set start frame
Current Frame	↺ <1-1000>	Select current frame to be played
End Frame	↺ <1-1000>	Set End frame

Note: the RUN/STOP button can also replay or continue the waveform display.

Storage: Store recorded waveforms to non-volatile memory according to setup frames.

Figure 2-104 Table 2-68

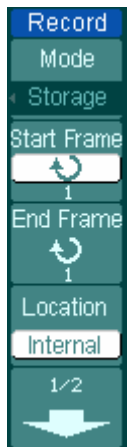



Menu	Settings	Comments
Start Frame	 <1-1000>	Set first frame to be saved
End Frame	 <1-1000>	Set last frame to be saved
Location	Internal external	Set up Store location

Figure 2-105 Table 2-69 when the save to Internal memory



Menu	Settings	Comments
Save		Save recorded waveform to internal memory location
Load		Recall recorded waveform from internal memory location
Imp./Exp.		Go to import/export menu (same as REF import/export menu. See table 2-10)

Figure 2-106 Table 2-70 when the save as external memory



Menu	Settings	Comments
Save		Go to save menu (same as REF save menu. See table 2-12)
Load		Go to load menu see table 2-63
Import		Go to import menu. (same as REF import menu see table 2-14)

Service

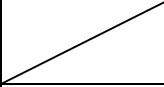
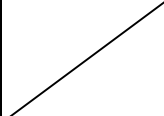
Press **Utility** → **Service** to go to the following menu.

Figure 2-107 Table 2-71



Menu	Settings
System Info	Press to display system information.
Screen Test	Press to run screen test program.
Color Test	Press to run color test
Key Test	Press to run keypad test program.

1. System Info:

Press this soft button to display the information of oscilloscope. It contains Model, Power up times, Serial No., Software version and Installed module of the oscilloscope. And you could follow the prompting message of "<<Press 'RUN' Key to Exit the Test>>" to exit this interface.

2. Screen Test:

Press this soft button to run Screen Test program. The screen turns black or white in sequence (Mono) and the screen turns red, green and blue in sequence (Color) when keep pressing the **RUN/STOP** button. You could check the screen for display failures.

3. Color Test:

select **Color Test** into color test screen, the hue, saturation, brightness, or red, green and blue components can be adjusted by turning (↻), confirm selection by pushing (↻) knob.

4. Key Test:

Press this soft button to run Keyboard Test program and start the keyboard test routine. The blocks represent the buttons on the front-panel; the rectangular boxes with two arrows beside represent the knobs on the front-panel; the square boxes represent the pressing function for the  SCALE knobs. Test all keys and knobs, and check the blocks on the screen response whether or not.

NOTE:

1. The corresponding block on the screen will temporary turn into green (Color models) or white (Mono models) when pressing a key.
2. The blocks will reverse its color to red (Color models) or black (Mono models) when the corresponding key or knob get pressed, and the color will keep reversed during the test.
3. Key backlight lamps will be lit one by one to determine if every backlight LED works well.
3. You could follow the prompting message of " <<Press RUN' Key Three Times to Exit the Test>>" to exit the test.

Language:

The DS1000 series oscilloscopes have multi-language user menu, choose as your desire.

Press **Utility** → **Language** to select the language.

To Measure Automatically

The **Measure** button in menu area activates the automatic measurement function. The instruction below will guide you using the DS1000 series powerful measurement function.

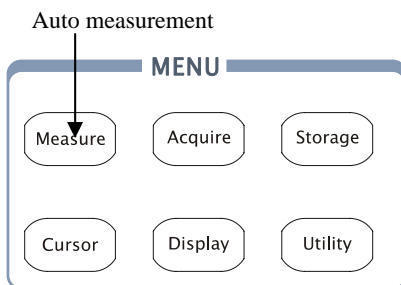

Figure 2-108

Menu explanation:

Press the **Measure** button to display the menu for the settings of the Automatic Measurements.

The oscilloscopes provide 20 parameters for auto measurement, including Vpp, Vmax, Vmin, Vtop, Vbase, Vamp, Vavg, Vrms, Overshoot, Preshoot, Freq, Period, Rise Time, Fall Time, Delay1-2 μ , Delay1-2 τ , +Width, -Width, +Duty, -Duty. That's 10 voltage and 10 time measurements in all.

Figure 2-109 Table 2-72



Menu	Settings	Comments
Source	CH1 CH2	Select CH1 or CH2 as source channel for measurement
Voltage		Select to measure voltage parameter
Time		Select to measure time parameter
Clear		Clear measurement result on screen
Display	OFF	Turn off all measurement result
All	ON	Turn on all measurement result

Page 1 for Voltage Measurements

Figure 2-110 Table 2-73



Menu	Settings	Comments
Vmax		Measure maximum voltage of a waveform
Vmin		Measure minimum voltage of a waveform
Vpp		Measure Peak-to-Peak Voltage
Vtop		Measure a flat top voltage of a square waveform

Page 2 for voltage measurements

Figure 2-111 Table 2-74



Menu	Settings	Comments
Vbase		Measure a flat base voltage of a square waveform
Vamp		Measure voltage between Vtop and Vbase
Vavg		Measure average voltage of a waveform
Vrms		Measure Root Mean Square Voltage of a waveform

Page 3 for Voltage Measurements

Figure 2-112 Table 2-75



Menu	Settings	Comments
Overshoot		Measure overshoot in percentage of an edge
Preshoot		Measure preshoot in percentage of an edge

Page 1 for Time Measurements

Figure 2-113 Table 2-76



Menu	Settings	Comments
Period		Measure Period of a waveform
Freq		Measure Frequency of a waveform
Rise time		Measure Rise Time of a rising edge
Fall time		Measure Fall Time of a falling edge

Page 2 for Time Measurements

Figure 2-114 Table 2-77

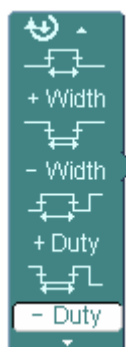

Menu	Settings	Comments
+Width		Measure +Pulse Width of a pulse wave
-Width		Measure -Pulse Width of a pulse wave
+Duty		Measure +Duty Cycle of a pulse wave
-Duty		Measure -Duty Cycle of a pulse wave

Page 3 for Time Measurements

Figure 2-115 Table 2-78



Menu	Settings	Comments
Delay1→2f		Measure the signals delay between two channels at the rising edge
Delay1→2t		Measure the signals delay between two channels at the falling edge

NOTE: The results of the automatic measurements will be displayed on the bottom of the screen. Maximum 3 results could be displayed at the same time. When there is no room, the next new measurement result will make the previous results moving left out of screen.

Using Automatic Measurement as the following steps demonstrate:

1. Select the signal channel for measuring. You could select CH1 or CH2 according to the signal you are interested in.

Press soft buttons as follows: **Measure** → **Source** → **CH1** or **CH2**.

2. To see all measurement value, set the **Display All** to **ON**. 18 measurement parameters will be displayed on the screen.

3. Select parameters page for measuring. You could select voltage or time parameters pages by pressing soft button as follows: **Measure** → **Voltage** or **time** → **Vmax**, **Vmin**.....

4. To get the measured value on the screen. You could select the parameters you are interested in by pressing the soft button on the right of the menu, and read the data on the bottom of the screen.

If the data is displayed as "*****", it means the parameter cannot be measured in current condition.

5. Clear the measure values: press **Clear**. Now, all of the auto measure values disappear from the screen.

Figure 2-116

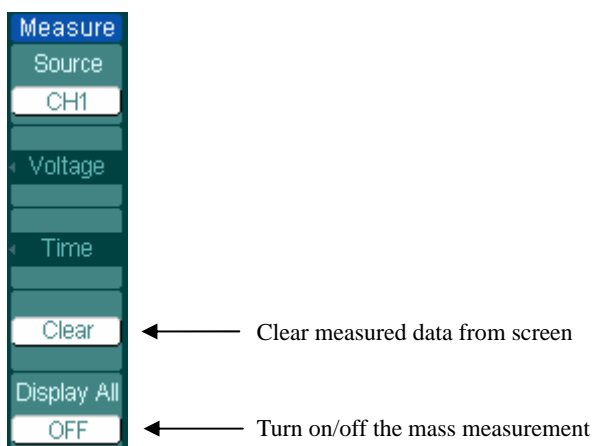

The automatic measurement of voltage parameters

The DS1000 series oscilloscopes provide automatic voltage measurements including V_{pp} , V_{max} , V_{min} , V_{avg} , V_{amp} , V_{rms} , V_{top} , V_{base} , **Overshoot** and **Preshoot**. Figure 2-117 below shows a pulse with some of the voltage measurement points.

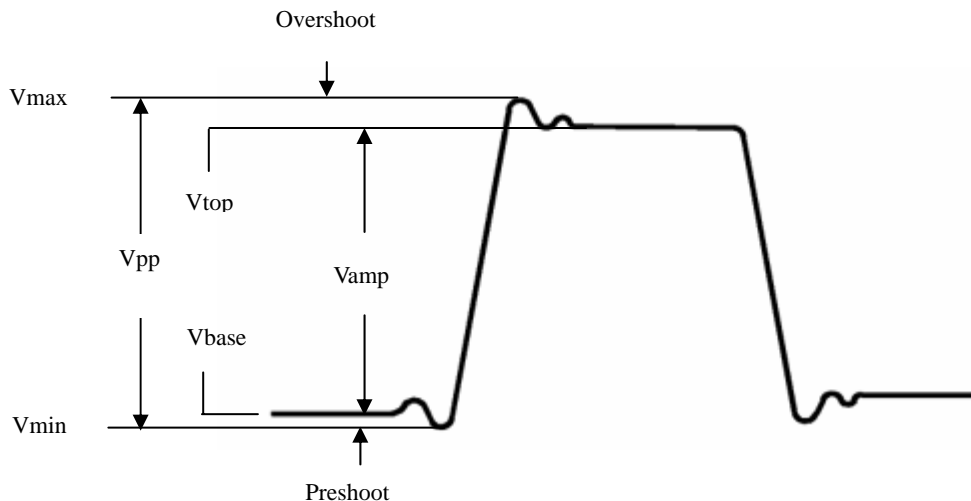

Figure 2-117

V_{pp} : Peak-to-Peak Voltage.

V_{max} : The maximum amplitude. The most positive peak voltage measured over the entire waveform.

V_{min} : The minimum amplitude. The most negative peak voltage measured over the entire waveform.

V_{amp} : Voltage between V_{top} and V_{base} of a waveform

V_{top} : Voltage of the waveform's flat top, useful for square/pulse waveforms.

V_{base} : Voltage of the waveform's flat base, useful for square/pulse waveforms.

****Overshoot:**** Defined as $(V_{max}-V_{top})/V_{amp}$, useful for square and pulse waveforms.

****Preshoot:**** Defined as $(V_{min}-V_{base})/V_{amp}$, useful for square and pulse waveforms.

****Average:**** The arithmetic mean over the entire waveform.

V_{rms} : The true Root Mean Square voltage over the entire waveform.

The automatic measurement of time parameters

The DS1000 series oscilloscopes provide time parameters auto-measurements include Frequency, Period, Rise Time, Fall Time, +Width, -Width, Delay 1→2 f , Delay 1→2 t , +Duty and -Duty.

Figure 2-118 shows a pulse with some of the time measurement points.

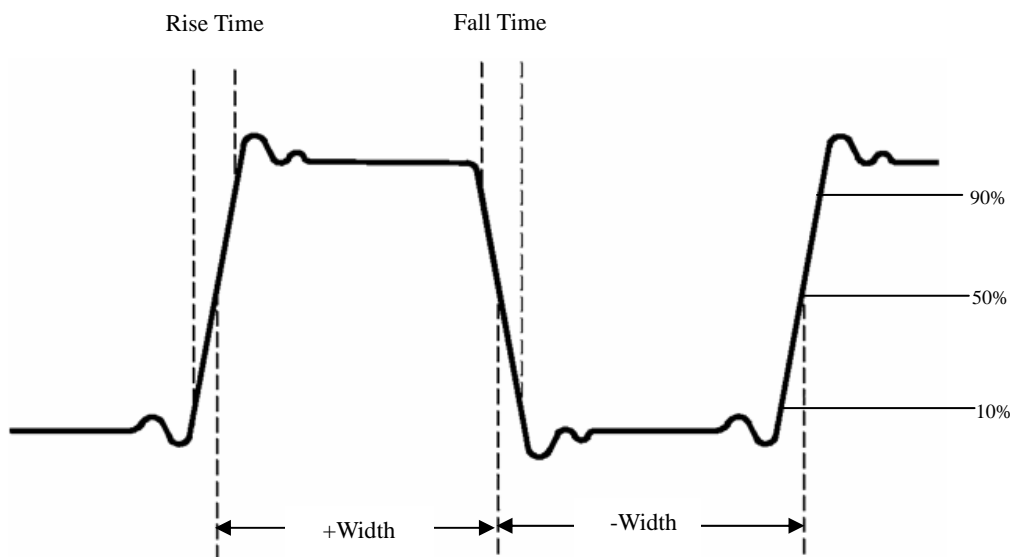

Figure 2-118

Rise Time: Time that the leading edge of the first pulse in the waveform takes to rise from 10% to 90% of its amplitude.

Fall Time: Time that the falling edge of the first pulse in the waveform takes to fall from 90% to 10% of its amplitude.

+Width: the width of the first positive pulse in 50% amplitude points.

-Width: the width of the first negative pulse in the 50% amplitude points.

Delay 1→2 f : the delay between the two channels at the rising edge.

Delay 1→2 t : the delay between the two channels at the falling edge.

+Duty: +Duty Cycle, defined as +Width/Period

-Duty: -Duty Cycle, defined as -Width/Period

To measure with cursors

Figure 2-119 displays the **Cursor** button on the front-panel.

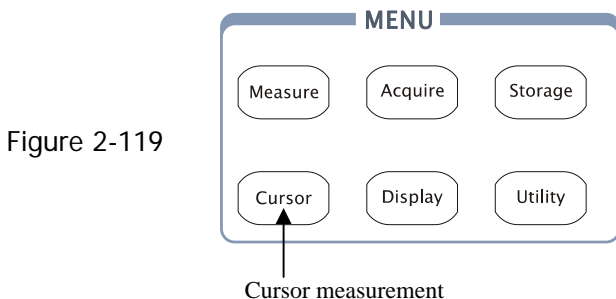

The cursor measurement has three modes: Manual, Track and Auto Measure.

1. **Manual:**

In this mode, the screen displays two parallel cursors. You can move the cursors to make custom voltage or time measurements on the signal. The values are displayed on the boxes below the menu. Before using cursors, you should make sure that you have set the Signal Source as the channel for measuring.

2. **Track:**

In this mode, the screen displays two cross cursors. The cross cursor sets the position on the waveform automatically. You could adjust cursor's horizontal position on the waveform by rotating the multifunctional knob (↻). The oscilloscope displays the values of the coordinates on the boxes below the menu.

3. **Auto Measure:**

This mode will take effect with Automatic Measurements. The instruments will display cursors while measuring parameters automatically. These cursors demonstrate the physical meanings of these measurements.

NOTE: The Auto Measure mode for Cursor measuring will take no effect without automatic measurements.

Menus and operations of Cursor Measurements

1. Manual Mode

Figure 2-120 Table 2-79



Menu	Settings	Comments
Mode	Manual	Adjust the cursor to measure X/Y parameters manually
Type	X	Shown as vertical line to measure the horizontal parameters
	Y	Shown as horizontal line to measure the vertical parameters
Source	CH1 CH2 MATH FFT LA	Select the measurement signal source. (LA is only applicable in Mixed Signal Oscilloscope)

In this mode, the oscilloscope measures the cursors' coordinate values for Y or X, and the increment between the two cursors.

To do manual Cursor Measurements, please do as the following steps:

1. Select the **Manual** mode for cursor measurement by pressing soft button as: **Cursor** → **Mode** → **Manual**.
2. Select channel **Source** for measurements by pressing soft button as: **Cursor** → **Source** → **CH1**, **CH2**, **MATH(FFT)**, or **LA**(Mixed Signal Oscilloscope)

NOTE: While measuring the channel of MATH, the results are valued with "d" (division) as units.

3. Select the cursors type by pressing soft button as **Cursor** → **Type** → **X** or **Y**.
4. Move the cursors to adjust the increment between the cursors: (Details in the following Table)

Table 2-80

Cursor	Increment	Operation
Cursor A	X	Turn the multifunctional knob (↻) to move cursor A horizontally
	Y	Turn the multifunctional knob (↻) to move cursor A vertically
Cursor B	X	Turn the multifunctional knob (↻) to move cursor B horizontally
	Y	Turn the multifunctional knob (↻) to move cursor B vertically

NOTE: Cursor could be moved only when the curse function menu is displayed.

5. To get measurement values:

Position of Cursor 1 (time cursor centered on the midpoint of screen; Voltage cursor centered on channel ground level).

Position of Cursor 2 (same as above).

Horizontal space between cursor 1 and 2 (ΔX) : Time between cursors ($1/\Delta X$), units in Hz, kHz, MHz, GHz.

Vertical space between cursor 1 and 2 (ΔY) : Voltage between cursors

If you choose the source as LA (Mixed Signal Oscilloscope), the measurement value is as follows:

Position of Cursor 1 (time cursor centered on the midpoint of screen).

Position of Cursor 2 (time cursor centered on the midpoint of screen).

Cursor 1 value: Hex.

Cursor 1 value: Binary.

Cursor 2 value: Hex.

Cursor 2 value: Binary.

NOTE: The values will be automatically displayed on the right upper corner of screen when the cursor function menu is hidden or displaying other menus.

Key Points





Cursor Y: Cursors Y appear as horizontal lines on the display and measure the vertical parameters. Usually it is used to measure the Volts. When the source is set as function, the units are assigned to the function.

Cursor X: Cursors X appear as vertical lines on the display and measure the horizontal parameters. Usually it indicates the time of trigger excursion. When the source is set as FFT, X means frequency

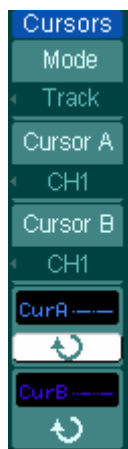
2. Track Mode

Figure 2-121 Table 2-81





Menu	Settings	Comments
Mode	Track	Set Track mode in cursor measurement
Cursor A	CH1 CH2 None	Set Cursor A in conjunction with CH1, CH2 or turn off Cursor A
Cursor B	CH1 CH2 None	Set Cursor B in conjunction with CH1, CH2 or turn off Cursor B
CurA (Cursor A)		Turn the multifunctional knob () to move cursor A horizontally
CurB (Cursor B)		Turn the multifunctional knob () to move cursor B horizontally

In cursor track mode, the cursors move together with the selected waveform.

To do Track mode Cursor Measurements, follow these steps:

1. Select the **Track** mode for cursor measurement by pressing soft button as: **Cursor** → **Mode** → **Track**.
2. Select channel **Source** for Cursor A and Cursor B by pressing soft button as: **Cursor** → **Cursor A** or **Cursor B** → **CH1**, **CH2** or **None**.
3. Move the cursors to adjust the horizontal positions of the cursors: (Details in the following Table)

Table 2-82

Cursor	Operation
Cursor A	Turn the multifunctional knob () to move cursor A horizontally
Cursor B	Turn the multifunctional knob () to move Cursor B horizontally

NOTE: Horizontally moving cursor is not possible when other(not tracking cursor) menu is activated.

(4) To get measurement value:

Position of Cursor 1 (Time cursor centered on the midpoint of screen; Voltage cursor centered on channel ground level).

Position of Cursor 2 (Time cursor centered on the midpoint of screen; Voltage cursor centered on channel ground level).

Horizontal space between cursor 1 and 2 (ΔX) :Time between cursors, units in Second.

($1/\Delta X$), units in Hz, kHz, MHz, GHz.

Vertical space between cursor 1 and 2 (ΔY) : Voltage between cursors, units in V.

3. Auto mode:

Figure 2-122



Table 2-83

Menu	Settings	Comments
Mode	Auto	Display the cursors for the current automatic measuring. (See the following figure)

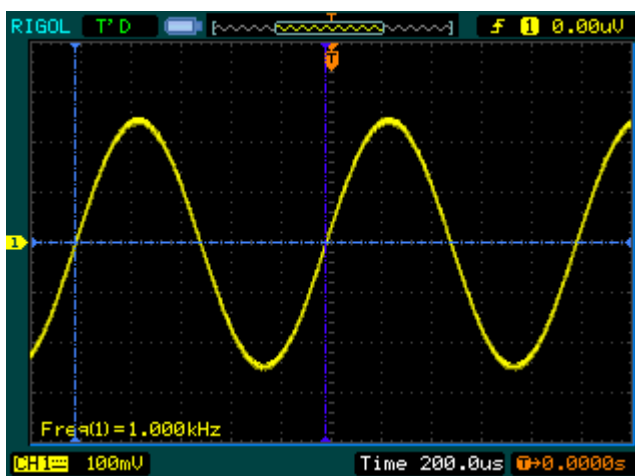

Figure 2-123: Auto Measure Mode of Cursor Measurement

There will be no cursor display if no parameter were chosen in Measure menu. The oscilloscope could move cursor automatically to measure 20 parameters in **Measure** menu.

To Use Run Control Buttons



The run control buttons include **AUTO** (auto setting) and **RUN/STOP**.

Auto:

The **AUTO** features automatic adjustments to produce a usable display of the input signal. When **AUTO** button is pressed, the following menu will appear.

Figure 2-124 Table 2-84

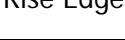
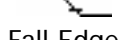

Menu	Settings	Comments
 Multi-Cycle	/	Press to display multi-cycle waveform on the screen
 Single Cycle	/	Press to display single cycle waveform on the screen
 Rise Edge	/	Press to display the waveform's rising edge and measure its rise time automatically
 Fall Edge	/	Press to display the waveform's falling edge and measure its fall time automatically
 (Cancel)	/	Press to cancel all the Auto Set actions, the oscilloscope will recover to its previous status

Auto-set functions

After the **AUTO** is pressed the oscilloscope is configured to the following defaults:

Table 2-85

Menu	Settings
Display format	Y-T
Acquire mode	Normal
Vertical coupling	Adjust to AC or DC according to the signal.
Vertical "V/div"	Adjusted
Volts/Div	Coarse
Bandwidth limit	Full
Signal Invert	OFF
Horizontal position	Center
Horizontal "S/div"	Adjust to right position
Trigger type	Edge
Trigger source	Find the channel with input signal automatically.
Trigger coupling	DC
Trigger voltage	Midpoint setting
Trigger mode	Auto
 POSITION knob	Trigger offset

RUN/STOP:

Run or Stop waveform acquiring.

NOTE:

In STOP status, the volts/div and horizontal time base can be adjusted in a fixed limit. That is, to zoom in/out the signal in vertical and horizontal directions.

Chapter 3 : Application & Examples

Example 1: Taking Simple Measurements

The function is used to observe the unknown signal and display and measure the frequency and peak-to-peak amplitude.

To quickly display a signal, please do the steps as follow:

1. Set the probe and the channel attenuations to 10X
2. Connect signal to CH1 with the probe
3. Press the **AUTO** button

The oscilloscopes set the vertical, horizontal, and trigger controls at the best status automatically. To optimize the display of the waveform, you could adjust these controls manually to meet your requirements.

Selecting Automatic Measurements

The oscilloscope could take automatic measurements on most signals. To measure the frequency and peak-to-peak amplitude, do these steps as follows:

1. Measure peak-to-peak amplitude
Press **Measure** → **Source** → **CH1** to set measurement source
Press **Voltage** → **Vpp** to select peak-to-peak measurements and the result will be displayed on the screen.
2. Measure frequency.
Press **Measure** → **Source** → **CH1** to set measurement source
Press **Time** → **Freq** to select peak-to-peak measurements and the result will be displayed on the screen.

NOTE: The frequency, period, and peak-to-peak measurements are shown on the screen and are updated periodically.

Example 2: View a Signal Delay Caused by a Circuit

This example is to test the input and output signals of a circuit and observe the signal delay. First, set the probe and the channel attenuation to 10X and connect CH1 probe to the input, CH2 to the output of the circuit.

Do these steps as follow:

1. Display the signals (CH1 and CH2):
 - 1) Press the **AUTO** button
 - 2) Adjust the vertical and the horizontal scale by turning the **SCALE** knobs to appropriate ranges for display.
 - 3) Press the **CH1** button to select CH1, and turn the vertical **POSITION** knob to adjust the vertical position of CH1's waveform.
 - 4) Press the **CH2** button to select CH2, and turn the vertical **POSITION** knob to adjust the vertical position of CH2's waveform.
2. Measure the delay time when a signal going through the circuit

Auto-measuring the delay:

Press **Measure** → **Source** → **CH1** to set measurement source

Press **Time** to select measurement Type

Press **Delay 1->2#** to display the result on the screen.

You can see the change of the waveform in the following figure:

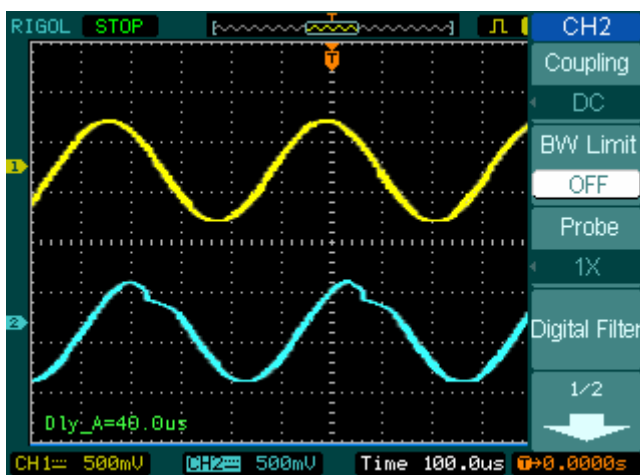

Figure 3-1: Delay of the signals

Example 3: Capture a Single-Shot Signal

To capture a single event, you need to gather some pre-test knowledge of the signal in order to correctly set up the trigger level and slope. For example, if the event is derived from TTL logic, a trigger level of 2 volts should work on a rising edge.

The following steps show you how to use the oscilloscope to capture a single event.

1. Set the probe and the channel attenuations to 10X.
2. Set up the trigger.
 - Press the **MENU** button in the Trigger control area to display the menu.
 - Press **Edge** to select trigger mode
 - Press **Slope** to select **Rising**
 - Press **Source** to select **CH1**
 - Press **Sweep** to select **Single**
 - Press **Set Up** → **Coupling** to select **DC**
3. Turn the vertical and horizontal **SCALE** knobs to adjust the Volts/Div and the Time base in a proper range for the signal
4. Turn the **LEVEL** knob to adjust trigger level
2. Press **RUN/STOP** button to start capturing. When the trigger conditions are met, data appears on the display representing the data points that the oscilloscope obtained with one acquisition.

This function can help you to capture the occurrence easily, such as the noisy with large amplitude; set the trigger level higher a little above the normal level and press **RUN/STOP** and wait. When noise occurs, the instrument will record the waveform before and after the trigger. Adjust the **POSITION** button in the horizontal control area and change the level of the trigger position, you will get the inverted delay trigger. It is useful when you want to observe the waveform before the occurrence of the noise.

Example 4: To Reduce the Random Noise on a Signal

If the signal applied to the oscilloscope is noisy (Figure 3-2), you can set up the oscilloscope to reduce the noise on the waveform and avoid its interference to the signal itself.

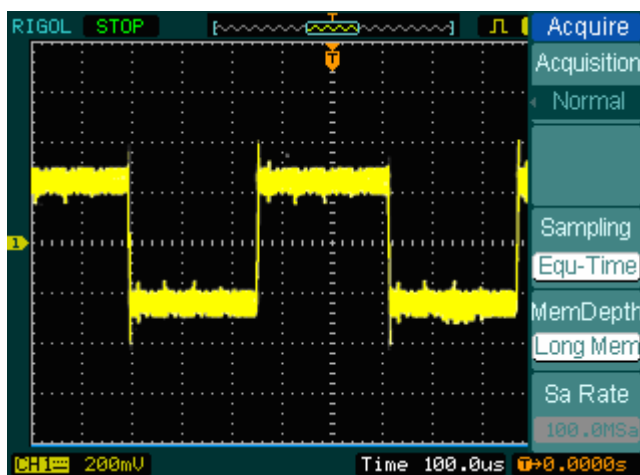

Figure 3-2

1. Set the probe and the channel attenuations to 10X.
2. Connect a signal to the oscilloscope and obtain a stable display.
3. Improve the trigger by setting the Coupling

(1) Press the **MENU** in the Trigger control area.

(2) Press **Set Up**→**Coupling**-->**LF Reject** or **HF Reject**

HF Reject (High frequency reject) adds a low pass filter with the -3 dB cutoff point at 150 kHz. Use HF rejects to remove high frequency noise such as AM or FM broadcast stations from the trigger path.

LF Reject (Low frequency reject) adds a high pass filter with the -3 dB cutoff point at 8 kHz. Use LF Reject to remove low frequency signals such as power line noise from the trigger path.

4. To reduce the noise by setting the acquisition type and adjust the waveform

intensity

- (1) If there is noise with the signal and the waveform looks too wide, in this case, you can choose average acquisition. In this mode the waveform will be thin and easy to observe and measure.

To use average follow these steps.

- Press soft button as **Acquire** → **Acquisition** → **Average**
- Toggle the **Averages** soft button to select the number of averages that best eliminates the noise from the displayed waveform. It can be adjusted from 2-256. (See Figure 3-3)

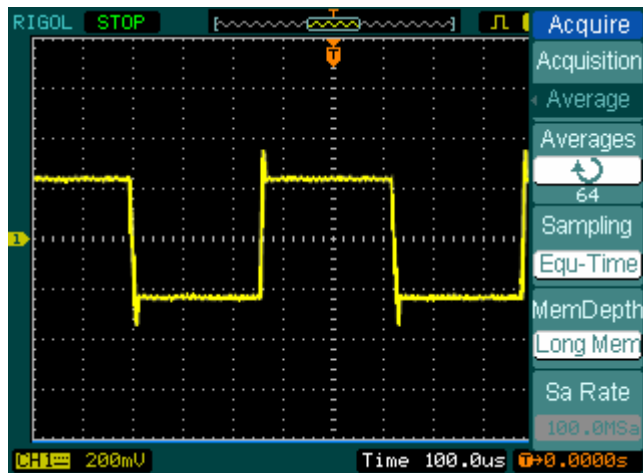

Figure 3-3

- (2) To reduce the noise also can be achieved by reduce the intensity of the waveform.

Note:

It is normal that the refresh rate will slow down when the average acquisition mode is turned on.

Example 5: Making Cursor Measurements

There are 20 most desired parameters that could be automatically measured with the oscilloscope. These parameters can also be measured using cursors. You could use the cursors to quickly make time and voltage measurements on a waveform.

Measuring the Frequency of the First Sinc Waveform Peak

To measure the ring frequency at the rising edge of a signal, do these steps:

1. Press **Cursor** key to see the Cursor menu.
2. Press **Mode** to set **Manual** mode.
3. Press **Type** to select **X**.
4. Turn (↻) knob to place cursor A on the first peak of the wave.
5. Turn (↻) knob to place cursor B on the second peak of the wave.

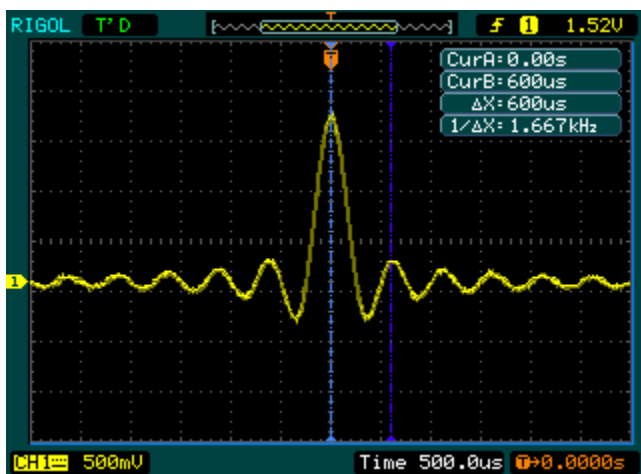

Figure 3-4

Then you can see the delta time and frequency

Measure the Amplitude of the First Waveform Peak of the Sinc.

Now let's measure the amplitude of the Sinc.

Please follow these steps:

1. Press **Cursor** key to see the Cursor menu.
2. Press **Mode** to set **Manual** mode
3. Press **Type** to select **V**.
4. Turn (↻) knob to place cursor A on the first peak of the wave.
5. Turn (↻) knob to place cursor B on the second peak of the wave.

You can see the following measurements in the cursor menu: (See Figure 3-5)

- The delta voltage (peak-to-peak voltage of the waveform)
- The voltage at Cursor 1
- The voltage at Cursor 2

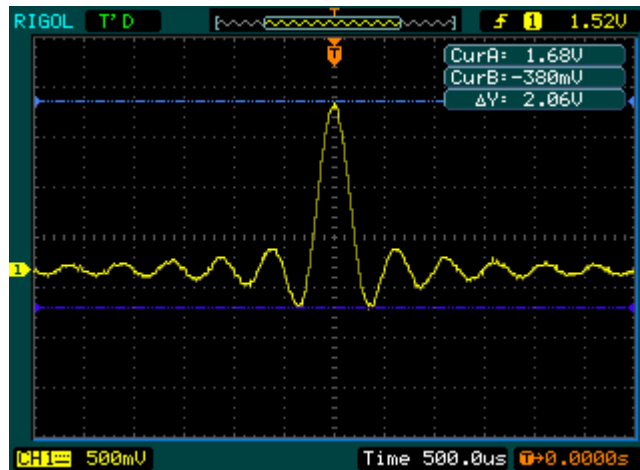

Figure 3-5

Example 6: The application of the X-Y operation

Viewing Phase Changes through a Network

Theme: Connect the oscilloscope to monitor the input and output of the circuit and capture the phase changes through the circuit.

To view the input and output of the circuit in an X-Y display, do these steps:

1. Set the probe menu attenuation to 10X. Set the switch to 10X on the probes.
2. Connect the channel 1 probe to the input of the network, and connect the channel 2 probe to the output.
3. If the channels are not displayed, press the **CH1** and **CH2** buttons.
4. Press the **AUTO** button
5. Adjust the vertical **SCALE** knob to display approximately the same amplitude signals on each channel
6. Press the **MENU** in horizontal control area to display the menu
7. Press the **Time Base** soft button to select **X-Y**

The oscilloscope displays a Lissajous pattern representing the input and output characteristics of the circuit

8. Adjust the vertical **SCALE** and **POSITION** knobs to display a desirable waveform.
9. Apply the Ellipse method to observe the phase difference between the two channels.

(See Figure 3-6)

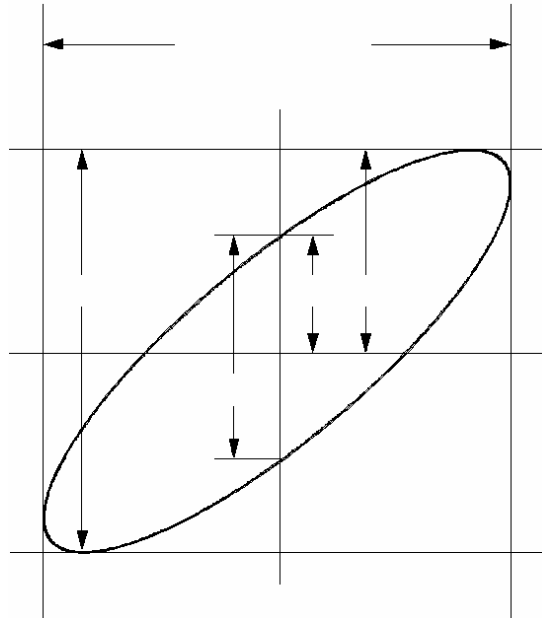

Figure 3-6

Sin = **A/B** or **C/D** where = phase shift (in degrees) between the two signals.

From the formula above, you could get

$$= \pm \arcsine (A/B) \text{ or } \pm \arcsine (C/D)$$

If the main axis of the ellipse is at I and III quadrant, must be in the range of $(0 \sim \pi/2)$ or $(3\pi/2 \sim 2\pi)$. If the main axis is at II and IV quadrant, must be in the range of $(\pi/2 \sim \pi)$ or $(\pi \sim 3\pi/2)$.

Example 7: Triggering on a Video Signal

Test a video circuit in the DVD set. Use video trigger to obtain a stable display.

Triggering on Video Fields

To trigger on the video fields, please do as the following steps:

- 1 Press the **MENU** key in the Trigger control area to see the Trigger menu.
- 2 Press **Mode** to select **Video** mode
- 3 Press **Source** to select **CH1** as trigger source
- 4 Press **Polarity** to select **┌┐**
- 5 Press **Sync** as **Odd Field** or **Even Field**
- 6 Adjust the **LEVEL** to set trigger level at the video sync pulse to get stable trigger.
- 7 Turn the horizontal **SCALE** knob to see a complete waveform on the screen.

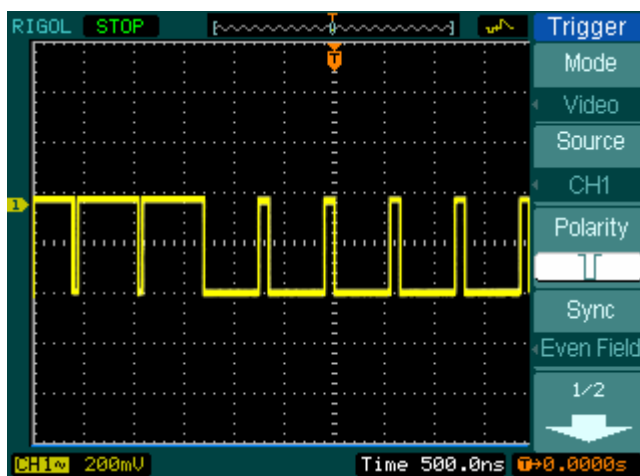

Figure 3-7

DS1000 series can trigger on the appointed Odd field or Even field, so as to avoid mix up when Odd field and Even field trigger simultaneously. Just choose **Odd field** or **Even field** as the fifth step above.

Triggering on the Video Lines

1. Press the **MENU** key in the triggering control area to see the trigger menu.
2. Press **Mode** to select **Video** mode
3. Press **Source** to select **CH1** as trigger source
4. Press **Polarity** to select **┌┐**
5. Press **Sync** to select **Line Num**
6. Turn (↻) knob to trigger on a specified line number
7. Adjust the **LEVEL** to set trigger level at the video sync pulse to get stable trigger.
8. Turn the horizontal **SCALE** knob to see a complete waveform on the screen

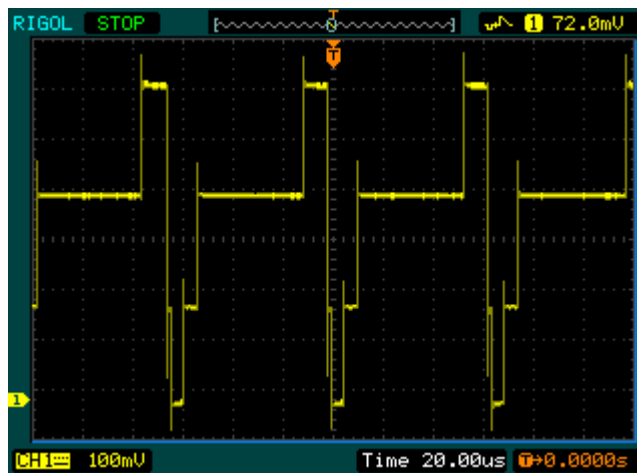

Figure 3-8

Example 8: FFT Cursor measurement

FFT measurements include: amplitude measurement (Vrms or dBVrms) and Frequency measurement (Hz).

Do these steps as follow:

1. Press **Cursor** → **Manual**
2. Press **Type** to select **X** or **Y**
3. Press **Source** to select **FFT**
4. Turn (↻) knob to move the cursor to an interesting point.

Figure 3-9

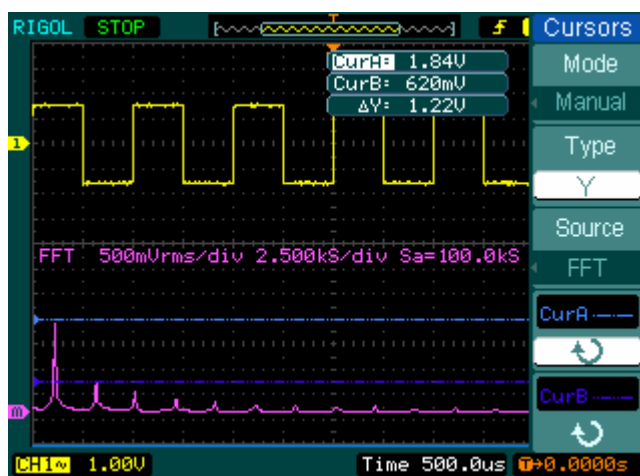
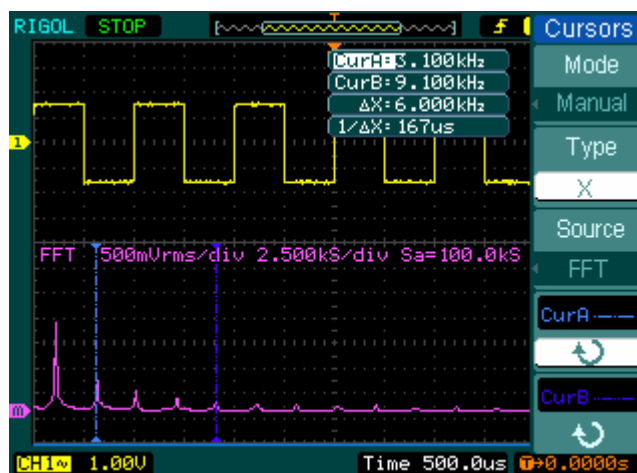

Figure 3-10



Example 9: Pass/Fail Test

The Pass/Fail Test is one of enhanced special functions based on DS5000 series. When running test function the oscilloscope automatically examines the input signal, compared to the already built waveform mask. If the waveform “touches” the mask, a “Fail” occurs, otherwise the test passes. When needed, a programmable output can be used for external automatic control applications, such as the automatic failure product kick-out in a production line. The output is built in as a standard feature, and is optically isolated.

Do the steps as following:

1. Press **Utility** → **Pass/Fail**
2. Press **Enable Test** and select **ON** to open the test.
3. Press **Mask Setting** → **Load**
4. Press **Load** to recall the saved mask or press **X Mask** and **Y Mask** to adjust the horizontal limit and vertical limit then press **Create Mask** to create a new mask.
4. Press **Output** to select the expected outputting waveforms.
5. Press **Operate** to start the test.

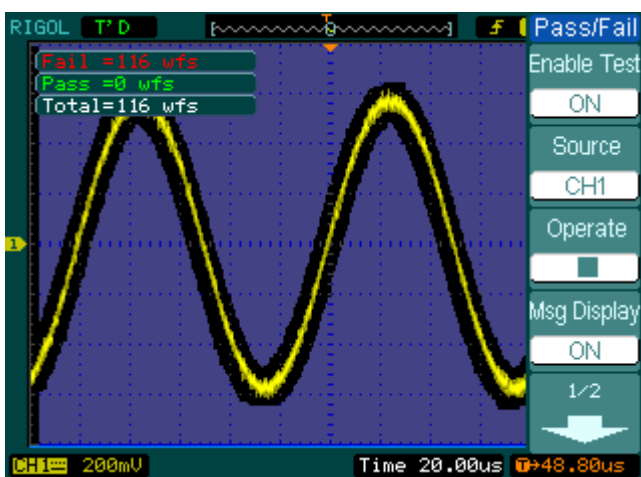



Figure 3-11

Chapter 4 : Prompt messages & troubleshooting

Prompting Message

Setting at limit: Prompts that the setting is at limit, can not be adjusted any further.

Trigger level at limit: Prompts that the trigger level is at limit while turning the  LEVEL knob.

Trigger position at limit: Prompts that the trigger position is at the start or the end point of the memory space while turning the horizontal  POSITION knob to adjust the trigger offset.

Volts/Div at limit: Prompts that the Volts/Div is at the limit of the full range while turning the vertical  SCALE knob.

Vertical position at limit: Prompts that the vertical position of waveform is at full range while turning the vertical  POSITION knob.

No active cursor: Prompts that you haven't set the cursor source while using the Track cursor measurements.

Delayed scale at limit: Prompts that it is at the full range of horizontal resolution under the Delayed Scan mode while turning the horizontal  SCALE knob.

Delayed position at limit: Prompts that the horizontal position of the zoom window is at limit under the Delayed Scan mode while turning the horizontal  POSITION knob.

Function not available: Prompts that this function is not available under current setting or the current setting is fixed without any adjustment.

Sampling at limit: Prompts that the sampling rate is at limit under the X-Y mode.

Real Time Div at limit: Prompts that the time base is up to the highest horizontal resolution under the Real-Time sampling mode.

Time/div at limit: Prompts that the horizontal scale is up to the highest horizontal resolution under the Equivalent-sampling mode.

Memory position at limit: Prompts that the Memo Offset is at the full range of the memory.

Save finished: Prompts that the storage progress has finished.

The storage is empty: Prompts that current position of the memory is empty to recall saved waveforms or settings.

Measurement already selected: Prompts that the measurement parameter you pressed is already displayed on screen.

Dot display only: Prompts that you could only use Dots type for display under this setting.

Failed operation on files: Prompts the failed operation on files in USB memory device

Failed print: Prompts the failed operation try to perform print.

Failed upgrade: prompts the failed upgrade from a USB drive

Files are covered: prompt the original file will be covered by a new file when store a new file to the memory.

Troubleshooting

1. After the oscilloscope is powered on, the screen remains dark, please inspect the instrument following these steps:

- (1) Check the power cable's connection
- (2) Ensure the power switch is turned on
- (3) After the inspections above, restart the oscilloscope
- (4) If the problem still remains, please contact **RIGOL** for help

2. After the signal acquisition the waveform does not appear, please check according to the following steps:

- (1) Check the probes connected with the signals
- (2) Check the probes connected to the channels firmly
- (3) Check the probes connected with the object being tested.
- (4) Check the circuit generates signal on the test point
- (5) Repeat the acquisition

3. The measurement result is 10 times higher or lower than the value expected.

Check if the probe attenuation is the same as the channel attenuation.

4. if the oscilloscope does not get a stable waveform display, please check according to the following steps:

- (1) Check the **Trigger Source** and notice if it is set to the channel you use
- (2) Check the **Trigger Type**. You should use "Edge" for normal signals, and use "Video" for VIDEO signals.
- (3) Switch the **coupling** into **HF Rejection** or **LF Rejection** in order to filter the noise which disturbs trigger.

5. After pressing the RUN/STOP button, the oscilloscope does not display any waveform on screen.

Check whether the **Trigger Mode** is set to "Normal" or "Single" and see whether

the trigger level is out of the signal range. If yes, you should set the trigger level in proper range by turning the **LEVEL** knob or pressing the **50%** button. You could also set the Trigger Mode as "AUTO". Moreover, you could push **AUTO** button to display the waveform on screen.

6. After the Acquisition is set to "Averages" or Display Persistence is set ON, the waveform refreshes slowly.

It is normal in these settings.

7. The signal is displayed as ladder like waveform.

- (1) The time base maybe is too slow. You can turn the horizontal **SCALE** knob to increase horizontal resolution to improve the display.
- (2) Maybe the display **Type** is set to "Vectors". You could set it to "Dots" mode to improve the display.

Chapter 5 : Support & Service

Warranty (DS1000 Series Digital Oscilloscopes)

RIGOL warrants that the products that it manufactures and sells will be free from defects in materials and workmanship for a period of three (3) years from the date of shipment from an authorized RIGOL distributor. If a product proves defective within the respective period, RIGOL will provide repair or replacement as described in the complete warranty statement.

To arrange for service or obtain a copy of the complete warranty statement, please contact your nearest RIGOL sales and service office.

Rigol do not provide any other warranty items except the one being provided by this summary and the warranty statement. The warranty items include but not being subjected to the hint guarantee items related to tradable characteristic and any particular purpose.

Rigol will not take any responsibility in cases regarding to indirect, particular and ensuing damage.

Chapter 6 : Appendix

Appendix A: Specifications

All specifications apply to the DS1000 Series Oscilloscopes and a probe with the Attenuation switch set to 10X unless noted otherwise. To meet these specifications, two conditions must first be met:

- 1 The instrument must have been operating continuously for thirty minutes within the specified operating temperature.
- 2 You must perform the Self Cal operation, accessible through the Utility menu, if the operating temperature changes by more than 5 ° C.

All specifications are guaranteed unless noted "typical".

Specifications

Acquisition		
Sampling Modes	Real-Time	Equivalent
Sampling Rate	400Sa/s 200MSa/s**	25GS/s
Averages	N time acquisitions, all channels simultaneously, N is selectable from 2, 4, 8, 16, 32, 64, 128 and 256	

Inputs	
Input Coupling	DC, AC, GND
Input Impedance	1M Ω ±2%, in parallel with 15pF±3pF
Probe Attenuation Factors	1X, 10X, 100X, 1000X
Maximum Input Voltage	400V (DC+AC Peak, 1M Ω input impedance)
	40V(DC+AC Peak)**
Time delay between channel (typical)	500ps

Horizontal	
Sample Rate Range	1Sa/s-400MSa/s (Real-Time), 25GSa/s (Equivalent)
Waveform interpolation	Sin(x)/x
Record Length	1M samples for single channel, 512K samples for each channel
	512K samples **
Scan speed Range (Sec/div)	5ns/div-50s/div, DS1102XX, DS1062XX 10ns/div-50s/div, DS1042XX 20ns/div-50s/div, DS1022XX 1-2-5 Sequence
Sample Rate and Delay Time Accuracy	±100ppm (over any 1ms time interval)
Delta Time Measurement Accuracy (Full Bandwidth)	Single-shot: ±(1 sample interval+100ppm×reading+0.6 ns) >16 averages: ±(1sample interval+100ppm×reading+0.4 ns)

Vertical	
A/D converter	8-bit resolution, each channel samples simultaneously*
Volts/div Range	2mV/div-5V/div at input BNC
Offset Range	$\pm 40V(200mV-5V)$, $\pm 2V(2mV-100mV)$
Analog Bandwidth	100MHz(DS1102CD, DS1102C, DS1102MD, DS1102M) 60MHz(DS1062CD, DS1062C, DS1062MD, DS1062M) 40MHz(DS1042CD, DS1042C, DS1042MD, DS1042M) 25MHz(DS1022CD, DS1022C, DS1022MD, DS1022M)
Single-shot Bandwidth	80MHz(DS1102CD, DS1102C, DS1102MD, DS1102M) 60MHz(DS1062CD, DS1062C, DS1062MD, DS1062M) 40MHz(DS1042CD, DS1042C, DS1042MD, DS1042M) 25MHz(DS1022CD, DS1022C, DS1022MD, DS1022M)
Selectable Analog Bandwidth Limit (typical)	20MHz
Lower Frequency Limit (AC -3dB)	$\leq 5Hz$ (at input BNC)
Rise Time at BNC, typical	$<3.5ns$, $<5.8ns$, $<8.7ns$, $<14ns$, On (100M) (60M) (40M) (25M) respectively
DC Gain Accuracy	2mV/div-5mV/div: $\pm 4\%$ (Sample or Average acquisition mode) 10mV/div-5V/div: $\pm 3\%$ (Sample or Average acquisition mode)
DC Measurement Accuracy, Average Acquisition Mode	Average of ≥ 16 Waveforms with vertical position at zero: $\pm(4\% \times \text{reading} + 0.1\text{div} + 1mV)$ at 2mV/div or 5mV/div $\pm(3\% \times \text{reading} + 0.1\text{div} + 1mV)$ at settings 10mV/div-5V/div Average of ≥ 16 Waveforms with vertical position not at zero: $\pm[3\% \times (\text{reading} + \text{vertical position}) + (1\% \text{ of vertical position}) + 0.2\text{div}]$ Add 2mV for settings from 2mV/div to 200 mV/div Add 50mV for settings from 200mV/div to 5V/div
Delta Volts Measurement Accuracy (Average Acquisition Mode)	Delta Volts between any two averages of 16 waveforms acquired under same setup and ambient conditions: $\pm(3\% \times \text{reading} + 0.05 \text{div})$

Trigger		
Trigger Sensitivity	0.1div-1.0div (adjustable)	
Trigger Level Range	Internal	±12 divisions from center of screen
	EXT	±1.6V
	EXT/5	±8V
Trigger Level Accuracy (typical) applicable for the signal of rising and falling time ≥20ns	Internal	±(0.3div×V/div)(±4 divisions from center of screen)
	EXT	±(6% of setting + 40 mV)
	EXT/5	±(6% of setting + 200 mV)
Trigger Offset	Normal mode: pre-trigger(262144/ sampling rate), delayed trigger 1s	
	Slow Scan mode: pre-trigger 6div, delayed trigger 6div	
Trigger Holdoff range	100ns-1.5s	
Set Level to 50% (Typical)	Input signal frequency ≥50Hz	
Edge Trigger		
Edge trigger slope	Rising, Falling, Rising + Falling	
Pulse Trigger		
Trigger condition	(>, <, =) Positive pulse, (>, <, =) negative pulse	
Pulse Width range	20ns – 10s	
Video Trigger		
Video standard & line frequency	Support standard NTSC, PAL and SECAM broadcast systems. Line number range: 1-525 (NTSC) and 1-625 (PAL/SECAM)	
Slope Trigger		
Trigger condition	(>, <, =) Positive slope, (>, <, =) negative slope	
Time setting	20ns – 10s	
Alternate Trigger		
Trigger on CH1	Edge, Pulse, Video, Slope	
Trigger on CH2	Edge, Pulse, Video, Slope	
Pattern Trigger **		
Trigger mode	D0 – D15 select H, L, X, \overline{F} , $\overline{7}$	
Duration Trigger **		
Trigger Type	D0 – D15 select H, L, X	
Qualifier	>, <, =	
Time setup	20ns – 10s	

Measurements		
Cursor	Manual	Voltage difference between cursors (ΔV) Time difference between cursors (ΔT) Reciprocal of ΔT in Hertz ($1/\Delta T$)
	Track	Voltage value for Y-axis waveform Time value for Y-axis waveform
	Auto	Cursors are visible for Automatic Measurement
Auto Measure	Vpp, Vamp, Vmax, Vmin, Vtop, Vbase, Vavg, Vrms, Overshoot, Preshoot, Freq, Period, Rise Time, Fall Time, +Width, -Width, +Duty, -Duty, Delay1→2 f , Delay1->2 t	

General Specifications

Display	
Display Type	5.7 in. (145 mm) diagonal TFT Liquid Crystal Display
Display Resolution	320 horizontal \times RGB \times 234 vertical pixels
Display Color	64K color (DS1000C、DS1000CD) Mono (DS1000M、DS1000MD)
Display Contrast (typical)	150:1
Backlight Brightness(typical)	300 nit

Probe Compensator Output	
Output Voltage(typical)	3 Vp-p into $\geq 1 \text{ M}\Omega$ load
Frequency(typical)	1KHz

Power	
Supply Voltage	100 ~ 240 VAC _{RMS} , 45-440Hz, CAT II
Power Consumption	Less than 50VA
Fuse	2A, T rating, 250 V

Environmental	
Ambient Temperature	Operating 10°C ~ 40°C
	Non-operating -20°C ~ +60°C
Cooling Method	Fan force air flow
Humidity	+35°C or below: ≤90% relative humidity
	+35°C ~ +40°C: ≤60% relative humidity
Altitude	Operating 3,000 m or below
	Non-operating 15,000 m or below

Mechanical		
Size	Width	303mm
	Height	154mm
	Depth	133 mm
Heavy	Without package	2.4 kg
	Packaged	3.8 kg

IP Degree
IP2X

Calibration Interval
The recommended calibration interval is one year

*Only one input channel is available when Sample rate is at 1=400MSa/s.

**Specification of DS100xD series Logic Analyzer

Appendix B: DS1000 Series Accessories

Standard Accessories:

- 1 Probe×2 (1.5m), 1:1, (10:1) Passive Probes

The passive probes have a 6MHz bandwidth with a rating of 150V CAT II when the switch is in the 1X position, and a Full oscilloscope bandwidth with a rating of 300 V CAT II when the switch is in the 10X position.

- 2 A set of Digital probe components (mixed signal oscilloscopes) include:

A data cable (Model: FC1868)

An active logic head (Model: LH1116)

Twenty test wire (Model: LC1150)

Twenty logic clips (Model: TC1100)

- 3 A Power Cord that fits the standard of destination country.
- 4 A User Manual
- 5 A User Registration Form

Optional Accessories:

- UltraScope for WIN98/2000/XP software
- DS1000 soft carrying case

Appendix C: General Care and Cleaning

General Care

Do not store or leave the instrument in where the LCD display will be exposed to direct sunlight for long periods of time.



CAUTION: To avoid damage to the instrument or probes, do not expose them to sprays, liquids, or solvents.

Cleaning

If this instrument requires cleaning, disconnect it from all power sources and clean it with a mild detergent and water. Make sure the instrument is completely dry before reconnecting it to a power source.

To clean the exterior surface, perform the following steps:

1. Remove loose dust on the outside of the instrument and probes with a lint-free cloth. Take care to avoid scratching the clear plastic display filter.
2. Use a soft cloth dampened with water to clean the instrument.

NOTICE: To avoid damage to the surface of the instrument or probes, do not use any abrasive or chemical cleaning agents.

Index

50%	1-18, 2-36	HF Reject	2-57
AC Coupling	2-4	Horizontal	6-2
AC Line	2-56	I/O setup	2-75
Accessories	VI, 6-7	Inputs	6-1
Acquire	2-59	Instant Execute Key	2-105
Acquisition	6-1	Invert a waveform	2-9
Alternative Trigger	2-46	Keyboard Test	2-89
Appendix	6-1	Language	2-90
AUTO	1-12, 2-105, 2-106	LEVEL	2-36
Auto Trigger	2-56	LF Reject	2-57
Automatic Measurement	2-91	Math	2-12
Average Acquisition	2-62	Measurements	6-5
Bandwidth Limit	2-6	Normal Trigger	2-57
Blackman Window	2-15	Nyquist Frequency	2-15
Channel Coupling	2-4	Optional	6-7
Cleaning	6-8	Pattern Trigger	2-50
Coarse/Fine	1-14, 2-8	Power	6-5
Color Test	2-88	Pretrigger	2-57
Cursor	2-98	Probe Attenuation	2-7
Cursor Measurements	2-98, 3-6	Probe compensation	1-9
DC Coupling	2-4	Probe Compensator	6-5
Display	6-5	Prompting messages	4-1
Display System	2-63	Pulse Trigger	2-39
Duration Trigger	2-51	Random Noise	3-4
Edge Trigger	2-38	Realtime Sampling	2-62
Envelope	2-62	Rectangle Window	2-15
Equivalent Sampling	2-62	REF	2-16
Ext and Ext/5	2-56	Roll Mode Display	2-32
Factory Setup	2-72	RUN/STOP	2-105
FFT	2-13	Sampling System	2-59
FORCE	1-19, 2-36	Save and Recal	2-65
Front panel	1-2	Screen Test	2-88
Functional check	1-7	Self- Calibration	2-77
GND Coupling	2-5	Single Trigger	2-57
Hamming Window	2-15	Slope Trigger	2-44
Hanning Window	2-15	STORAGE	2-65

Sync Pulses	2-42	Vertical	6-3
Trigger	6-4	Vertical System	2-2
Trigger Control	1-17	Vertical Window	1-13
Trigger Settings	2-53	Video Signal	3-10
Trigger System	2-36	Video Trigger	2-41
Troubleshooting	4-3	X-Y	2-32
UTILITY	2-73	Y-T	2-32