

20' x 20' Pinnacle User's Manual



A world leader in manufacturing of engineered fabric products and distribution of event equipment.



**5373 State Route 29, Celina Ohio, 45822
Phone: 419-586-3610; 866-438-8368 (Toll Free) Fax: 419-584-0949**

CONTENTS

CONGRATULATIONS!	2
WARRANTY	2
WARNING	2
BEFORE YOU DIG	2
INSTALLATION SITE INSPECTIONS	3
PACKING LIST	3
PARTS BREAKDOWN.....	3
PINNACLE SETUP INSTRUCTIONS	4
DISASSEMBLE THE TENT	7
TENT CARE, CLEANING AND STORAGE	7
VINYL CLEANER.....	7
VINYL REPAIR	7
CUSTOMER SUPPORT	7
Appendix 1 “Call before you dig”	8

CONGRATULATIONS!

Congratulations on your purchase of this 20' x 20' Pinnacle Tent. The Pinnacle High Peak Frame Tent is designed and installed using tensioned cross cables, instead of a center pole or interior frame which supports a high peak flying mast generating an elegant look for any occasion. The 16 oz. blackout vinyl top is tensioned down at each corner pole using our ratcheting rope lock system. The Pinnacle Cross Cable Tents provide quick and easy storage and can be installed in minutes with only 2 people since fewer fittings and parts are necessary than with traditional pole and frame tents.

It is suggested that you read the entire assembly instructions completely before you begin. This will help attain the best results for your installation.

WARRANTY

Celina Tent Inc. Warrants our product will be free from defects in material and workmanship for a period of one (1) year following the date of purchase. Defects are limited to any defect which is a result of manufacturing process. Excluded are holes, punctures, or other damages which can be caused during normal installation of a tent, whenever proper procedures are not followed. Celina Tent Inc. at its option, will repair or replace this product or any component of product found to be defective during this warranty period. This warranty is valid for the original purchaser only, and is not transferable. This warranty does not cover normal wear or damage resulting from negligent use or misuse of the product, use contrary to instructions, repair or alteration by anyone other than Celina Tent Inc. or forces of nature.

This warranty is in lieu of all other warranties, and there are no warranties, expressed or implied, including warranties of merchantability of fitness for a particular purpose, which extend beyond the description on the face hereof. Celina Tent Inc. shall not be liable for any incidental or consequential damages. Some jurisdictions do not allow the exclusion of implied warranties or the imitation on incidental or consequential damages, so the above exclusions and limitations may not apply to you.

Color variations are an inherent characteristic of vinyl products. We work closely with our vinyl supplier to ensure quality and uniformity of the product and that any variations are kept to a minimum.

WARNING

Tent products are manufactured for use as temporary structure and do not meet structural code, unless specified. Since weather is unpredictable, the customer must incorporate their own good judgment, common sense & knowledge of local conditions with the installation instruction guidelines. The customer is responsible to anticipate weather severity for proper time and method of construction.

BEFORE YOU DIG

By Law you are required to contact your local “Call before you dig” number before you plan to dig. After calling, your local utility company will mark the location of underground utility lines. Laws from state to state vary on how far in advance you must call. Planning ahead and checking with your state’s program is always a smart idea. Failure to obtain a line location before digging can result in a substantial fine. Please find your local “call before your dig number” in the appendix section of this manual.



INSTALLATION SITE INSPECTIONS









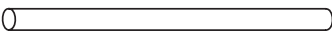
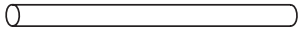
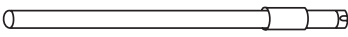

The customer must evaluate each installation site and determine the proper securing and anchoring method and device appropriate for the conditions. Some soils require different staking or securing than what may be purchased with standard tent package. Celina tent Inc, highly recommends the customer engages in thorough training with their tent installers. Celina tent Inc "tent instructions" and "layout Handbook" summarize all the functions of each product, the rules for using them and suggestions for their use. Celina Tent Inc, video instructions illustrate general graphic examples of operating techniques. Following the instruction given under the condition specified or illustrated will provide proven satisfactory results. However, field situation, site conditions, weather and local experience may mandate other methods. Celina's layouthand book and instructional videos can be viewed at www.GetTent.com.

PACKING LIST

Please check to make sure you have all parts required:

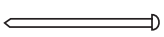
PARTS LIST			
Box 1 of 4	Box 2 of 4	Box 3 of 4	Box 4 of 4
1-Tent Top	2-Cross Cables 4-Rope Ratchet Locks 4-Corner Fittings 4-Base Plates	4-Alum 8' Legs 4-Alum 15" Spreader Inserts 1-Center Mast Top Pin 4-22" Stakes	8-Alum 9'3" Spreaders Pole 1-Alum Center Mast Pole

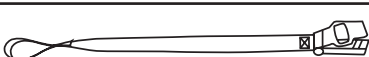
PARTS BREAKDOWN

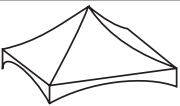
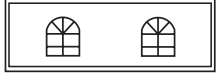
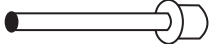
No. / Letter	Description (Item #)	Qty	Picture
1	Spreader Bars (CCASTIII)	8	
2	Legs (CCAST96)	4	
3	Center Mast Assembly (CC03CMB)	1	
A	Corner Fitting (CC01COR)	4	
B	Spreader Inserts (CCAST91)	4	
C	Base Plate (CC02BP)	4	
	Cross Cables (CC20C)	2	
	Ratchet Ropes (CCRRL)	4	
	22" Stakes (CCAP22)	4	
	42" Stakes (ACTS4211)	4	
	2" Ratchet Straps (AC05SGR)	4	
	Loop Strap (AC08SPGR) w/ Carabiner (HWOP06)	4	
D	Tent Top (020020CC50)	1	
E	Sidewalls		 Sidewalls (optional)
	*ACSW810CC50	4	
	*ACSW820CC50	2	
F	Center Mast Pole Pin (CCPP)	1	

ADDITIONAL PARTS
4- 2" Ratchet Buckle Straps
4- 2" Loop Straps w/ Carabiner
4- 42" Stakes

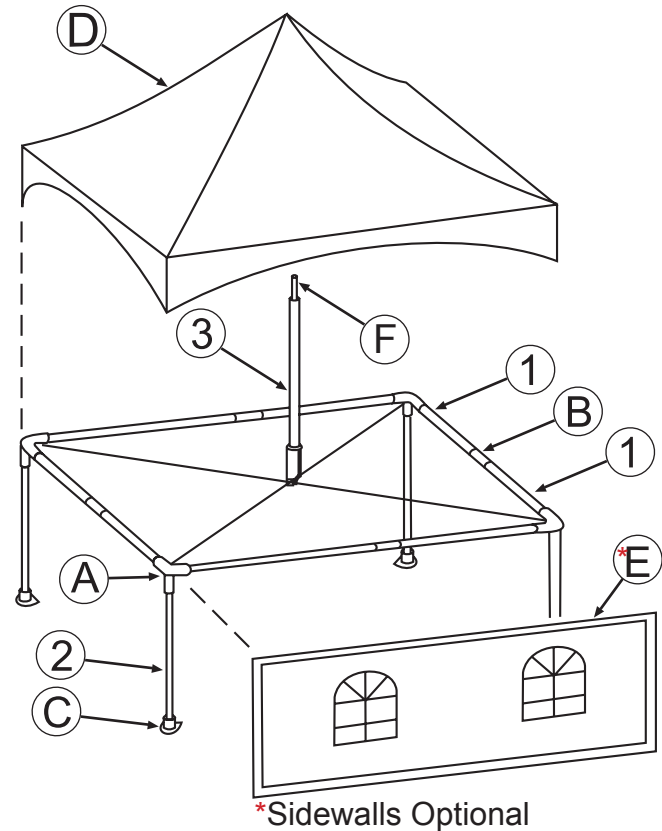

*Sidewalls Optional

*Window sidewalls also available
Item # are ACSW810CC50W, ACSW820CC50W

20' X 20' PINNACLE SETUP INSTRUCTIONS

- 1) Lay out a drop cloth in the area the tent will be installed.
 - a. Drop Cloth Sold Separately, not included in tent package.
- 2) Lay out all parts in their respective positions forming a square on top of the drop cloth.
- 3) Start in the middle of one side by connecting both ends of the 15" spreader insert to each of the 9'3" spreader poles. Continue this until all four sides are completed (See Diagram: I & II).

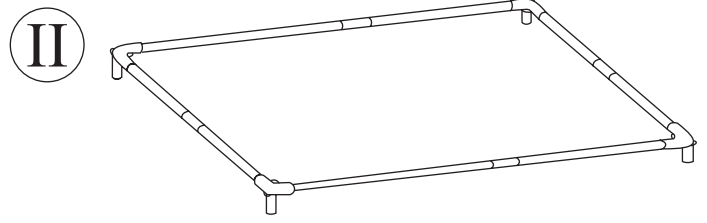
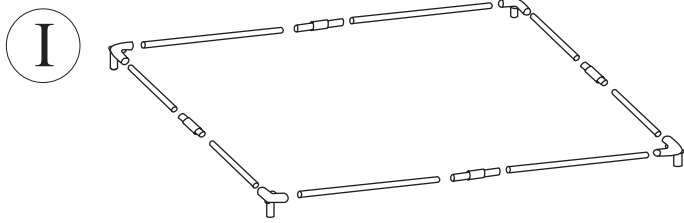

- 4) Starting at a corner, insert the spreader pole (9'3" connected tube) into the corner fitting.
- 5) Continue to insert all spreaders into the corner fittings until a square is formed.
- 6) Connect one cross cable to the inside hook on the corner fitting. Connect the other end of this cable to the hook on the corner fitting at the diagonal corner.
- 7) Connect the second cross cable to the remaining two corner fittings in the same way
 - a. In order to fit the cable onto the 4th corner fitting hook, you may need to lift the frame up in that corner approximately 4 feet. This reduces the distance between the corners allowing the cable to reach the 4th corner fitting hook (See Diagram: III & IV).

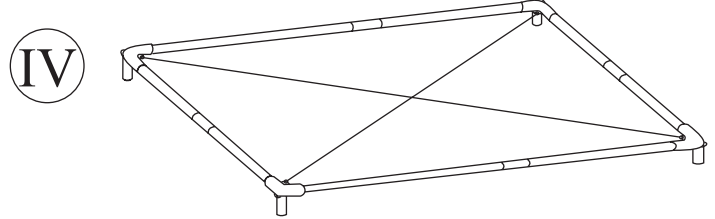
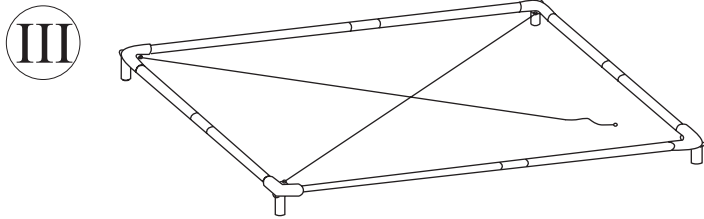

- 8) Lay the tent top out over the cables and frame with the top of the tent facing upward. Start in one corner by securing the white nylon strap over the ring on the outside of the corner fitting (See Diagram V).

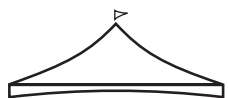
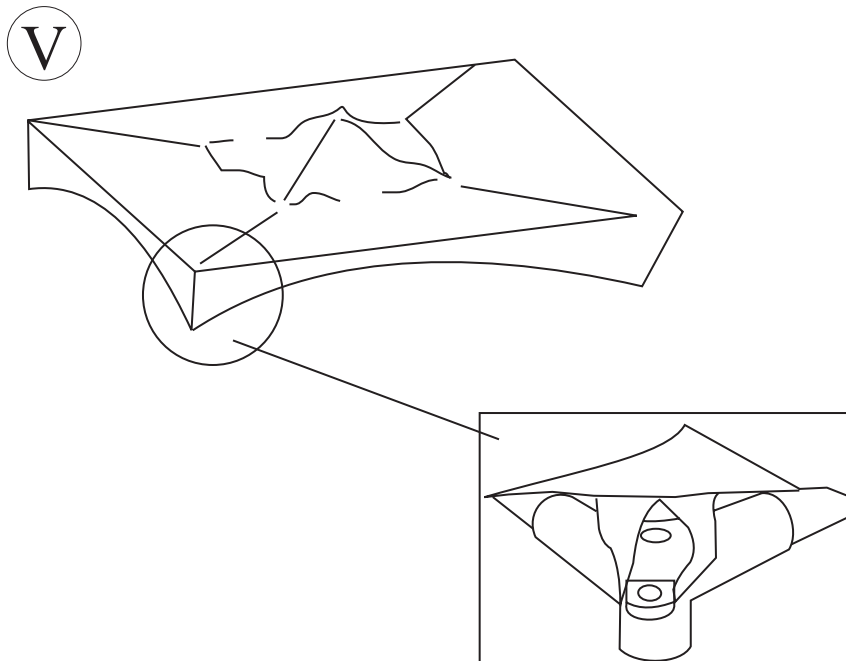

20' X 20' PINNACLE SETUP INSTRUCTIONS CONTINUED

9) Continue to secure all the tent corner straps to the outside corner fittings. Make sure that the strap with the ring on it is the last one to be secured. You will use this ring and strap when securing the top over the last fitting.

10) Once the top is in place and secured, you're ready to install the legs. Lift one side of the tent up and install the legs (8') at each corner, leaving the tent at an angle (See Diagram: VI). Attach the base plate to each leg with the smaller holes facing the interior of the tent. At each leg use the ratchet rope lock, place the tension rope from the tent top into the oval shaped ring on the rope lock. Screw the oval ring back in place after the rope is secured inside. Tie a loop knot in the open ended rope at the bottom. Place this loop on the hook in the base plate and pull the rope to tighten the ratchet putting tension on the tent top. This will keep the legs secure when installing the center mast.

11) Now you need to install the center mast through the tent top. Place the center mast pin at the top of the center mast pole. Unhook the clip at the bottom of the center mast pole and position the bottom of the center mast pole onto the cables. Slide the center mast pole up the cables making sure the mast pin at the top goes through the hole and is visible from the outside of the tent top. Move the center mast pole to the center of the tent making sure it rests on both cross cables. Once in place put the clip back on the bottom of the center mast pole making sure it is under the cables to keep it in place (See Diagram: VI).

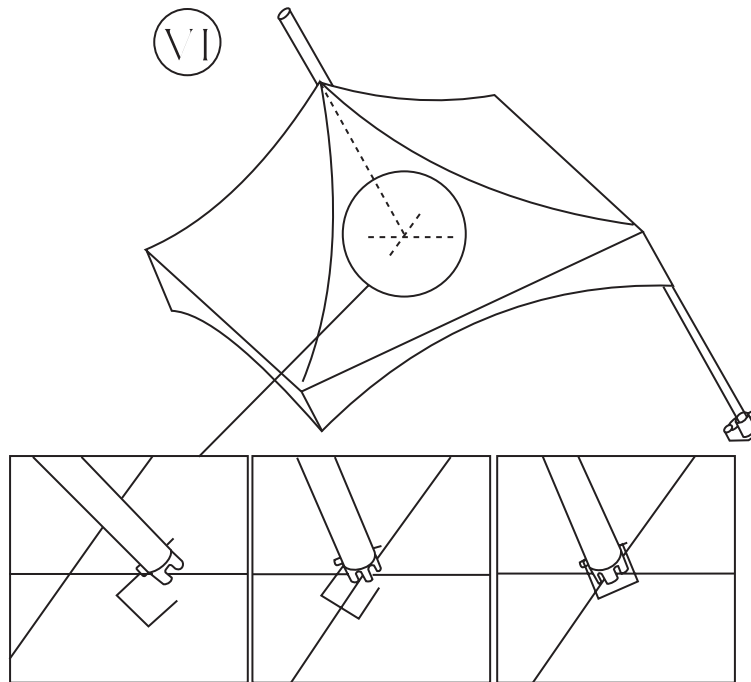

12) Install the remaining two legs (8') as done in step #10 be sure the smaller holes of the base plate is facing the interior of the tent.

13) Secure each base plate by driving a 22" stakes into the smaller hole in the front of the base plate. Place the four legs (8') into the larger hole of the base plate once the plates have been installed (See Diagram: VII).

VII

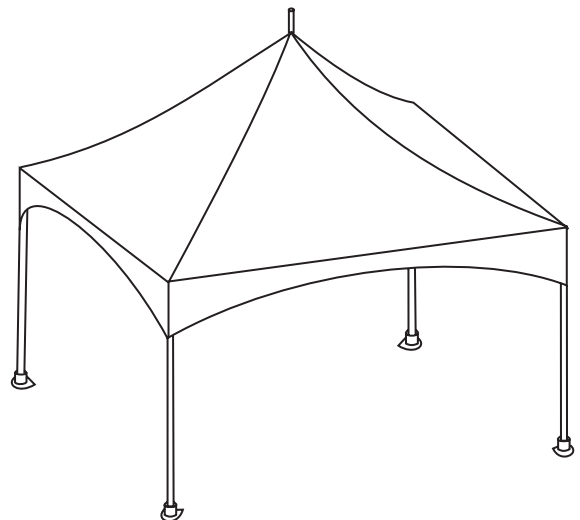
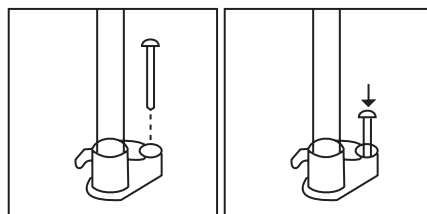

20' X 20' PINNACLE SETUP INSTRUCTIONS CONTINUED

Sidewall Setup instructions: (this step is optional)

- The sidewalls are designed to hang around the outside of the legs with the ratchet rope on the exterior of the sidewalls.
- Hang each sidewall by buckling the straps on the top of the side wall around the spreader bar that runs around the perimeter of the tent. Each sidewall will cover a distance between two legs. Loosen the tent top tension if it is difficult to get the straps around the spreader bar
 - Tighten the hanging straps so the sidewall is hanging at the appropriate height or fit with the ground surface the tent is setting on. Tuck the ends of each sidewall between the rope ratchet and the tent leg. Make sure the sidewall is center between the two legs.

VIII

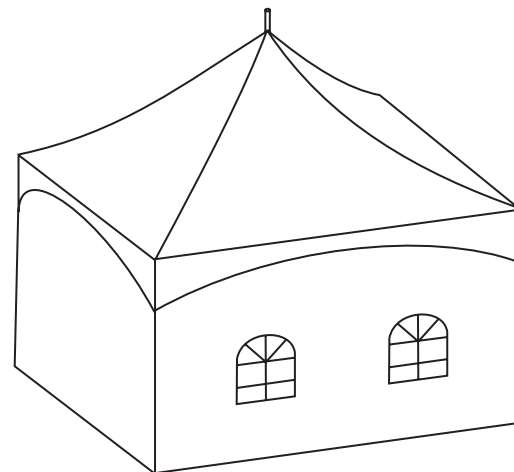
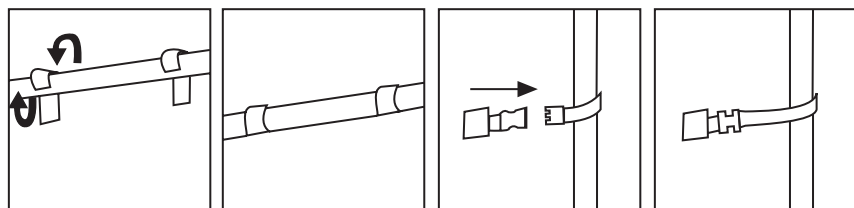

14) Your tent should be erected. Now adjust the ratchet rope locks to properly tension the tent top. Adjust all four corners until the tent top is tight (See Diagram: IX).

15) Drive the 4- 42" anchoring pins into the ground approximately 4' to 5' at an angle from each base plates. For best results, the top of the stakes should only be approximately 4" above the ground (See Diagram: IX).

16) Using the 2" ratchet buckle assemblies, secure the carabiner to the ring on the outside of the corner fittings (the same ring that the tent top is secured to). Install the loop end by pulling the strap through the ratchet buckles. Put the loop over the 42" anchoring pin and pull it tight. Click the ratchet to tighten the tent. (See Diagram: IX)

IX

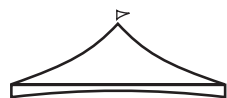
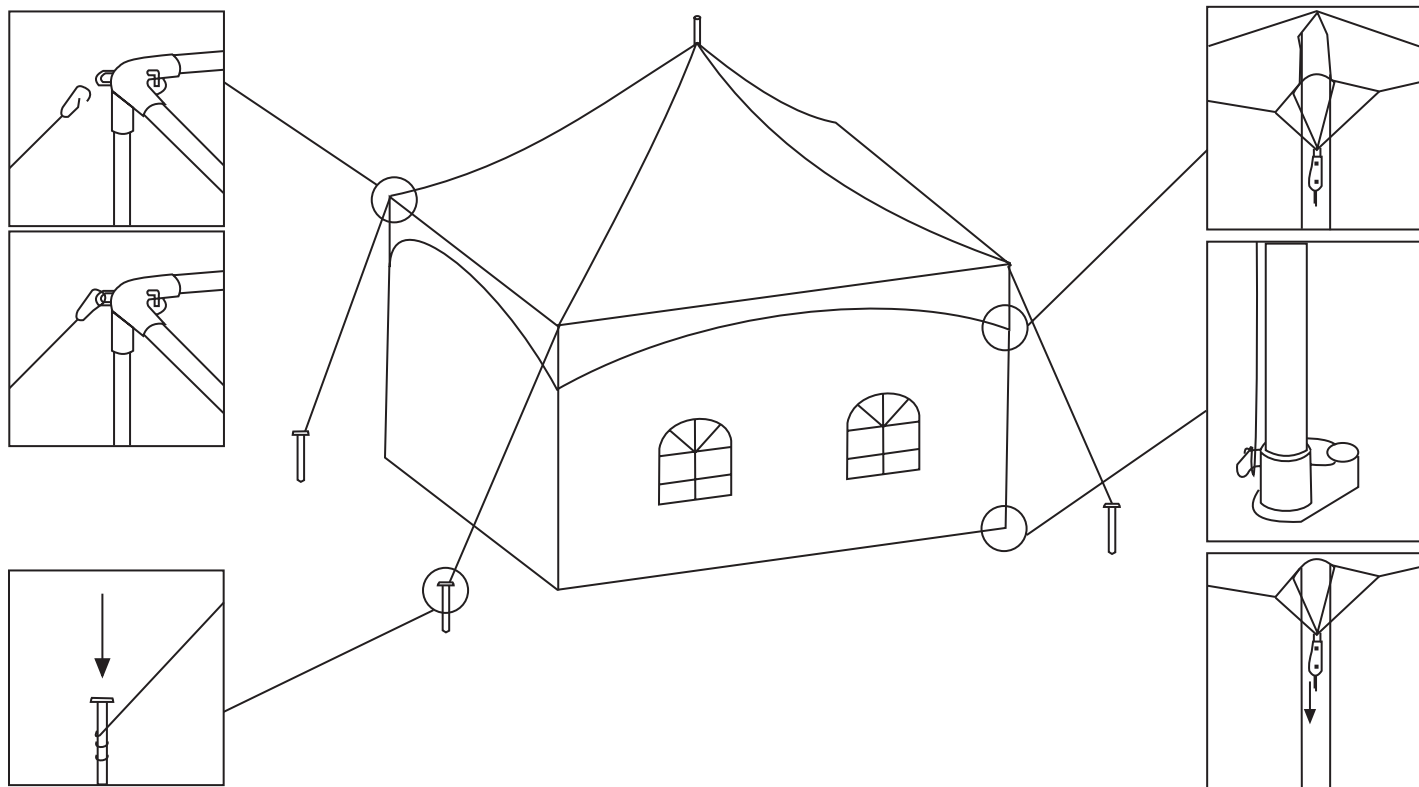

DISASSEMBLE THE TENT

Simply reverse the instructions above. Take extra care in windy conditions to avoid tent from damage and personal injury.

TENT CARE, CLEANING AND STORAGE

For maximum life of Celina fabrics, Celina recommends regular cleaning with the use of a soft brush with neutral soaps or cleaners, such as Celina Tent Cleaner, Ivory dish soap, or warm water. Thorough rinsing and drying is required before storing them.

Things that will cause premature degradation and reduced life expectancy of your tents:

- Extended use of the tent without cleaning
- Accumulation of dirt on the vinyl surface will promote the growth of mold and mildew and premature wear.
- Storage of vinyl that has not been dried thoroughly
- Even a slightly damp product can promote the growth of mildew when folded and stored. Mold and/or mildew may require harsh cleaners to remove, which may cause premature wear. The best solution is to take every precaution to keep mold and mildew from growing in the first place.
- Harsh Detergents and Cleaners, which contain a Solvent or Bleach
- The longer the exposure of PVC vinyl to these products, the more it will reduce the life of the PVC vinyl. If you or your customer decides to use a product containing a solvent or bleach, it is very important to remove it as quickly as possible, rinsing thoroughly and drying.
- High Abrasive Cleaners, including Wire Brushes, Power Washers and/or Commercial Washing Machines will result in premature wear and deterioration of tent fabrics.
- During installation/dismantling tents or canopies improper handling such as on a rough surface can create pinholes and abrasions.
- Wind whip will also damage the tent.

VINYL CLEANER

First impressions are important; therefore, make your tents shine with our vinyl cleaning products. Many rental companies rely on referrals to increase their business so make sure your tent is clean and mildew free for your next event. Please visit GetTent.com for more information on our cleaning products.

VINYL REPAIR

Avoid an embarrassing situation by being prepared for small accidents that can happen in the field during tent installations. Celina's repair products provide a quick and easy applicable solution to small tears and puncture holes when there is no time to spare. Our repair kits are equipped with multiple colors for versatility in the field. Please visit GetTent.com for more information on our vinyl repair products.

CUSTOMER SUPPORT

If you have any questions, please contact Celina Tents support department at:
support@celinatent.com
1-866-GET-TENT / 419-586-3610
www.GetTent.com



APPENDIX 1 "CALL BEFORE YOU DIG" NUMBER

STATE	CENTER	PHONE
Alabama	Alabama Line Location	800/292-8525
Alaska	Locate Call Center of Alaska	800/478-3121
Arizona	Arizona Blue Stake	800/782-5348
Arkansas	Arkansas One Call System	800/482-8998
California	Underground Service Alert	800/227-2600
Colorado	Utility Notification Center of Colorado	800/922-1987
Connecticut	Call Before You Dig	800/922-4455
Delaware	Miss Utility of Delaware	800/282-8555
Florida	Call Sunshine	800/432-4770
Georgia	Utilities Protection Center	800/282-7411
Hawaii	Underground Service Alert North	800/227-2600
	Underground Service Alert South	800/227-2600
Idaho	Palouse Empire Underground	800/822-1974
	Utilities Underground Location Center	800/424-5555
	Dig Line	800/342-1585
	One Call Concepts - Idaho	800/626-4950
	Shoshone County One Call	800/398-3285
Illinois	Chicago Utility Alert Network	800/892-0123
Indiana	Indiana Underground Plant Protection	800/382-5544
Iowa	Underground Plant Location Service	800/292-8989
Kansas	Kansas One-Call Center	800/344-7233
Kentucky	Kentucky Underground Protection	800/752-6007
Louisiana	Louisiana One Call System	800/272-3020
Maine	Dig Safe - Maine	888/344-7233
Maryland	Miss Utility	800/257-7777
	Miss Utility of DESMARVA	800/282-8555
Massachusetts	Dig Safe-Massachusetts	888/344-7233
Michigan	Miss Dig System	800/482-7171
Minnesota	Gopher State One Call	800/252-1166
Mississippi	Mississippi One Call System	800/277-6477
Missouri	Missouri One Call System	800/344-7483
Montana	Utilities Underground Location Center	800/424-5555
	Montana U-Dig	800/551-8344
Nebraska	Diggers Hotline	800/331-5666
Nevada	Underground Service Alert North	800/227-2600
New Hampshire	Dig Safe-New Hampshire	888/344-7233
New Jersey	Garden State Underground	800/272-1000
New Mexico	New Mexico One Call System	800/321-2537
	Las Cruces-Dona Ana Utility Council	888/526-0400

STATE	CENTER	PHONE
New York	Dig Safely New York	800/926-7962
	New York City-Long Island One Call	800/272-4480
North Carolina	North Carolina One Call	800/634-4949
North Dakota	North Dakota One Call	800/795-0555
Ohio	Ohio Utilities Protective Service	800/362-2764
	Oil & Gas Producers Underground	800/925-2988
Oklahoma	Call Okie	800/522-6543
Oregon	Oregon Utilities Notification Center	800/332-2344
Pennsylvania	Pennsylvania One Call System	800/242-1776
Rhode Island	Dig Safe-Rhode Island	888/344-7233
South Carolina	Palmetto Utility Protection Service	800/922-0983
South Dakota	South Dakota One Call	800/781-7474
Tennessee	Tennessee One-Call System	800/351-1111
Texas	Texas One Call System	800/245-4545
	Texas Excavation Safety System	800/344-8377
Utah	Lone Star Notification System	800/669-8344
Vermont	Blue Stakes Location Center	800/622-4111
Virginia	Dig Safe - Vermont	888/344-7233
	Miss Utility of Virginia	800/552-7001
	Miss Utility	800/257-7777
Washington	Miss Utility of DELMARVA	800/441-8355
	Notification Center	800/424-5555
	Utilities Council of Cowlitz County	360/425-2506
	UpperYakima City Underground	800/553-4344
	Inland Empire Utility Coordinating	509/456-8000
West Virginia	Miss Utility of West Virginia	800/245-4848
Wisconsin	Diggers Hotline	800/242-8511
Wyoming	Wyoming One Call	800/348-1030
	Call Before you Dig Wyoming	800/849-2476
District of Columbia	Miss Utility	800/257-7777
Canada	Alberta One Call	800/242-3447
	Ontario	800/400-2255
	Info-Excavation (Quebec)	800/663-9228
	BC One Call	800/474-6886
	Manitoba - Winnipeg	240/480-1212
	Manitoba & Saskatchewan Safe	800/827-5094

