AccuSync LCD52VM

AccuSync LCD72VM

AccuSync LCD92VM

User's Manual

NEC

**WARNING**

TO PREVENT FIRE OR SHOCK HAZARDS, DO NOT EXPOSE THIS UNIT TO RAIN OR MOISTURE. ALSO, DO NOT USE THIS UNIT'S POLARIZED PLUG WITH AN EXTENSION CORD RECEPTACLE OR OTHER OUTLETS UNLESS THE PRONGS CAN BE FULLY INSERTED.

REFRAIN FROM OPENING THE CABINET AS THERE ARE HIGH VOLTAGE COMPONENTS INSIDE. REFER SERVICING TO QUALIFIED SERVICE PERSONNEL.

**CAUTION:**

TO REDUCE THE RISK OF ELECTRIC SHOCK, DO NOT REMOVE COVER (OR BACK). NO USER SERVICEABLE PARTS INSIDE. REFER SERVICING TO QUALIFIED SERVICE PERSONNEL.



This symbol warns user that uninsulated voltage within the unit may have sufficient magnitude to cause electric shock. Therefore, it is dangerous to make any kind of contact with any part inside this unit.



This symbol alerts the user that important literature concerning the operation and maintenance of this unit has been included. Therefore, it should be read carefully in order to avoid any problems.

Caution:

When operating the AccuSync LCD52VM/AccuSync LCD72VM/AccuSync LCD92VM with a 220-240V AC power source in Europe, use the power cord provided with the monitor.

In the UK, a BS approved power cord with a moulded plug has a Black (five Amps) fuse installed for use with this equipment. If a power cord is not supplied with this equipment please contact your supplier.

For all other cases, use a power cord that matches the AC voltage of the power outlet and has been approved by and complies with the safety standard of your particular country.

Declaration**Declaration of the Manufacturer**

We hereby certify that the colour monitor AccuSync LCD52VM (L154F0)/AccuSync LCD72VM (L174F1)/AccuSync LCD92VM (L194F2) are in compliance with

Council Directive 73/23/EEC:
– EN 60950-1

Council Directive 89/336/EEC:
– EN 55022
– EN 61000-3-2
– EN 61000-3-3
– EN 55024

and marked with



NEC Display Solutions, Ltd.
4-13-23, Shibaura,
Minato-Ku
Tokyo 108-0023, Japan

As an ENERGY STAR Partner, NEC Display Solutions of America, Inc. has determined that this product meets the ENERGY STAR guidelines for energy efficiency. ENERGY STAR is a U.S. registered mark. The ENERGY STAR emblem does not represent EPA endorsement of any product or service.

ErgoDesign is a registered trademark of NEC Display Solutions, Ltd. in Austria, Benelux, Denmark, France, Germany, Italy, Norway, Spain, Sweden, U.K..

IBM PC/XT/AT, PS/2, MCGA, VGA, 8514/A and XGA are registered trademarks of International Business Machines Corporation.

Apple and Macintosh are registered trademarks of Apple Computer Inc.

Microsoft and Windows are registered trademarks of the Microsoft Corporation.

NEC is a registered trademark of NEC Corporation.

All other trademarks or registered trademarks are property of their respective owners.

For the Customer to use in U.S.A. or Canada

Canadian Department of Communications Compliance Statement

DOC: This Class B digital apparatus meets all requirements of the Canadian Interference-Causing Equipment Regulations.

Cet appareil numérique de la classe B respecte toutes les exigences du Règlement sur le matériel brouiller du Canada.

C-UL: Bears the C-UL Mark and is in compliance with Canadian Safety Regulations according to CSA C22.2 No. 60950-1.

Ce produit porte la marque 'C-UL' et se conforme aux règlements de sûreté Canadiens selon CAN/CSA C22.2 No. 60950-1.

FCC Information

- Use the attached specified cables with the AccuSync LCD52VM/AccuSync LCD72VM/AccuSync LCD92VM colour monitor so as not to interfere with radio and television reception.
 - The power supply cord you use must have been approved by and comply with the safety standards of U.S.A., and meet the following condition.

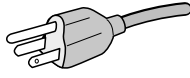
Power supply cord	Non shield type, 3-conductor
Length	1.8 m
Plug shape	
	U.S.A

- Please use the supplied shielded video signal cable. Use of other cables and adapters may cause interference with radio and television reception.
- This equipment has been tested and found to comply with the limits for a Class B digital device, pursuant to part 15 of the FCC Rules. These limits are designed to provide reasonable protection against harmful interference in a residential installation. This equipment generates, uses, and can radiate radio frequency energy, and, if not installed and used in accordance with the instructions, may cause harmful interference to radio communications. However, there is no guarantee that interference will not occur in a particular installation. If this equipment does cause harmful interference to radio or television reception, which can be determined by turning the equipment off and on, the user is encouraged to try to correct the interference by one or more of the following measures:
 - Reorient or relocate the receiving antenna.
 - Increase the separation between the equipment and receiver.
 - Connect the equipment into an outlet on a circuit different from that to which the receiver is connected.
 - Consult your dealer or an experienced radio/TV technician for help.

If necessary, the user should contact the dealer or an experienced radio/television technician for additional suggestions. The user may find the following booklet, prepared by the Federal Communications Commission, helpful: "How to Identify and Resolve Radio-TV Interference Problems." This booklet is available from the U.S. Government Printing Office, Washington, D.C., 20402, Stock No. 004-000-00345-4.

Declaration of Conformity

This device complies with Part 15 of FCC Rules. Operation is subject to the following two conditions. (1) This device may not cause harmful interference, and (2) this device must accept any interference received, including interference that may cause undesired operation.

U.S. Responsible Party:	NEC Display Solutions of America, Inc.
Address:	500 Park Blvd, Suite 1100 Itasca, Illinois 60143
Tel. No.:	(630) 467-3000

Type of Product:	Display Monitor
Equipment Classification:	Class B Peripheral
Model:	AccuSync LCD52VM (L154F0)/AccuSync LCD72VM (L174F1)/ AccuSync LCD92VM (L194F2)



We hereby declare that the equipment specified above conforms to the technical standards as specified in the FCC Rules.

Contents

Your new NEC AccuSync LCD monitor box* should contain the following:

- AccuSync LCD monitor with tilt base
- Audio Cable
- Power Cord
- Video Signal Cable
- User's Manual
- CD-ROM
- Base Stand
- Cable Holder

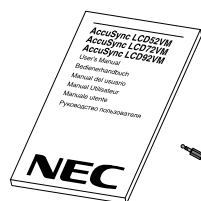

User's Manual



Audio Cable

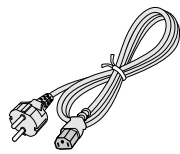

Power Cord

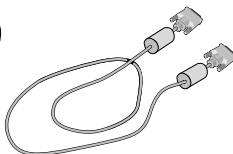

Video Signal Cable



Cable Holder

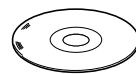

CD-ROM



Base Stand



AccuSync LCD monitor
(base stand not connected)

* Remember to save your original box and packing material to transport or ship the monitor.

Quick Start

To attach the Base to the LCD Stand:

1. Insert the front of the LCD stand into the holes in the front of the Base (**Figure S.1**).
2. Next, position the locking tabs on the back side of the LCD stand with the holes on the Base. Lower the Stand in place until locking tabs are secure (**Figure S.1**).

To attach the Cable Holder:

1. Insert the tabs of Cable Holder into the hole of Stand neck (**Figure S.1**).

NOTE: Please confirm that the tabs are completely secure.

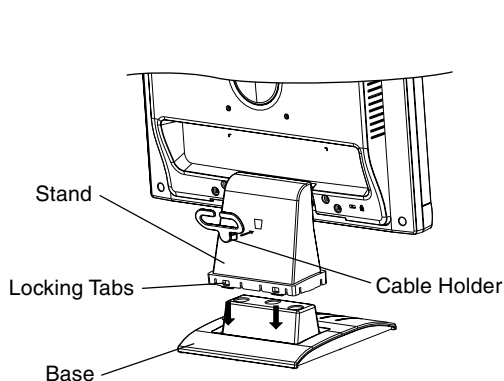
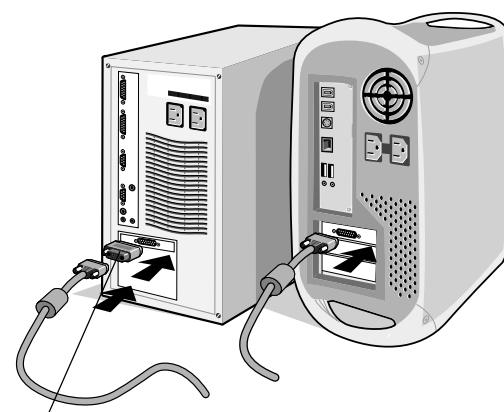

Figure S.1



Figure A.1



Macintosh Cable
Adapter (not included)

Figure A.2

To attach the AccuSync LCD monitor to your system, follow these instructions:

1. Turn off the power to your computer.
2. **For the PC with Analog output:** Connect the 15-pin mini D-SUB signal cable to the connector of the display card in your system (**Figure A.1**). Tighten all screws.

For the Mac: Connect the MultiSync Macintosh cable adapter (not included) to the computer. Attach the 15-pin mini D-SUB signal cable to the MultiSync Macintosh cable adapter (**Figure A.2**). Tighten all screws.

NOTE: Some Macintosh systems do not require a Macintosh cable adapter.

3. Connect the 15-pin mini D-SUB of the video signal cable and Audio Cable to the appropriate connector on the back of the monitor (**Figure B.1**). Connect the Headphone (not included) to the appropriate connector at the front of the monitor (**Figure C.1**).
4. Connect one end of the power cord to the monitor and the other end to the power outlet. Place the Video Signal Cable and power cord to the Cable holder (**Figure B.1**).

NOTE: Adjust position of cable that place under the Cable holder to avoid damage for cable or monitor.

NOTE: Please refer to Caution section of this manual for proper selection of power cord.

5. Turn on the monitor with the front power button and the computer (**Figure C.1**).

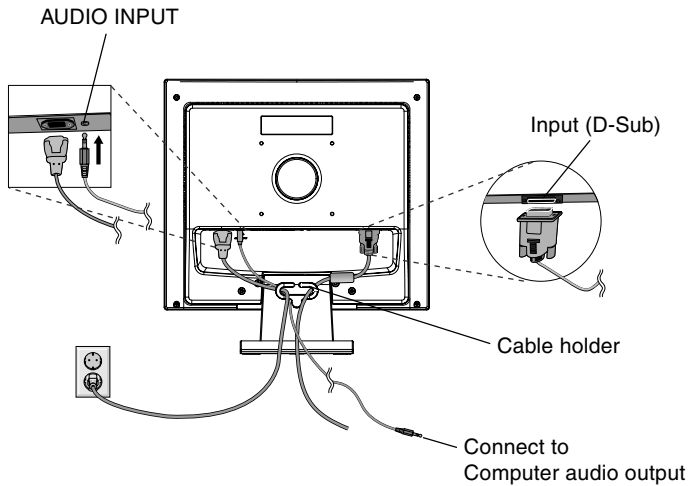

Figure B.1

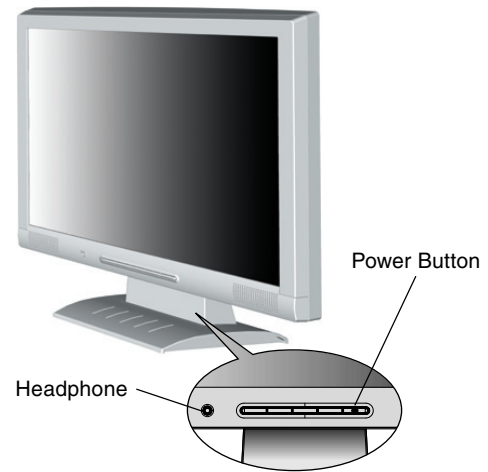

Figure C.1

6. No-touch Auto Adjust automatically adjusts the monitor to optimal settings upon initial setup for most timings. For further adjustments, use the following OSM controls:

- Auto Adjust Contrast
- Auto Adjust

Refer to the **Controls** section of this User's Manual for a full description of these OSM controls.

NOTE: If you have any problem, please refer to the **Troubleshooting** section of this User's Manual.

Tilt

Grasp both sides of the monitor screen with your hands and adjust the tilt as desired (**Figure TS.1**).

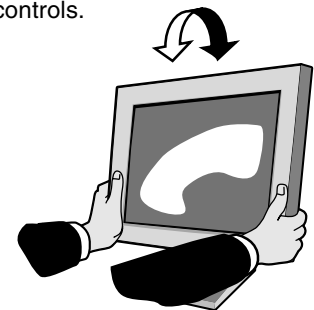

Figure TS.1

Remove Monitor Stand for Mounting

To prepare the monitor for alternative mounting purposes:

1. Disconnect all cables.
2. Place monitor face down on a non-abrasive surface (**Figure R.1**).
3. Remove the 4 screws connecting the monitor to the stand and remove the stand as indicated (**Figure R.2**). The monitor is now ready for mounting in an alternative manner.
4. Connect the AC cord and signal cable to the back of the monitor (**Figure R.3**).
5. Reverse this process to re-attach stand.

NOTE: Use only VESA-compatible alternative mounting method.

NOTE: Handle with care when removing monitor stand.

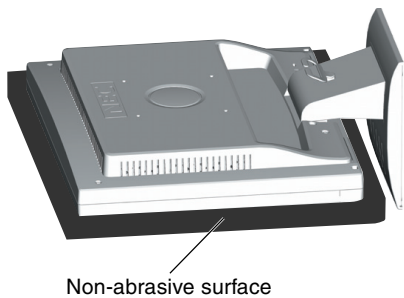

Figure R.1

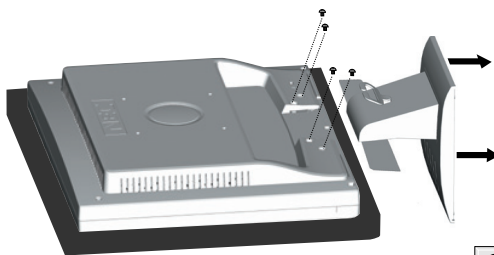

Figure R.2

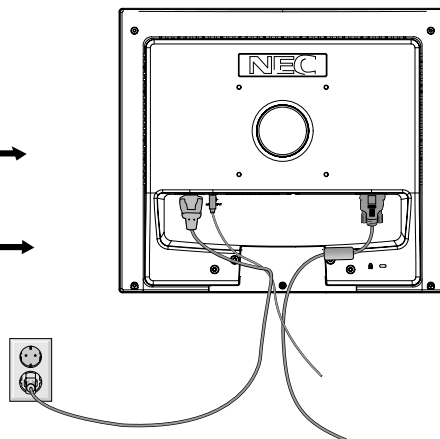
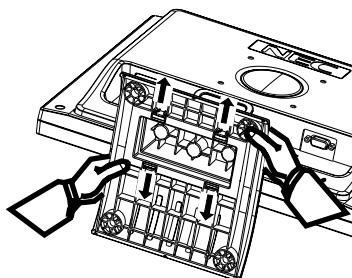

Figure R.3

Removing the Base

NOTE: Always remove the Base when shipping the LCD.

1. Place monitor face down on a non-abrasive surface (**Figure R.1**).
2. While using your thumbs, press the bottom tabs upward to unlock.
3. Press the top tabs down to unlock and pull off the stand.



Connecting a Flexible Arm

This LCD monitor is designed for use with a flexible arm.

Please use the attached screws (4pcs) as shown in the picture when installing. To meet the safety requirements, the monitor must be mounted to an arm which guaranties the necessary stability under consideration of the weight of the monitor.

The LCD monitor shall only be used with an approved arm (e.g. GS mark).

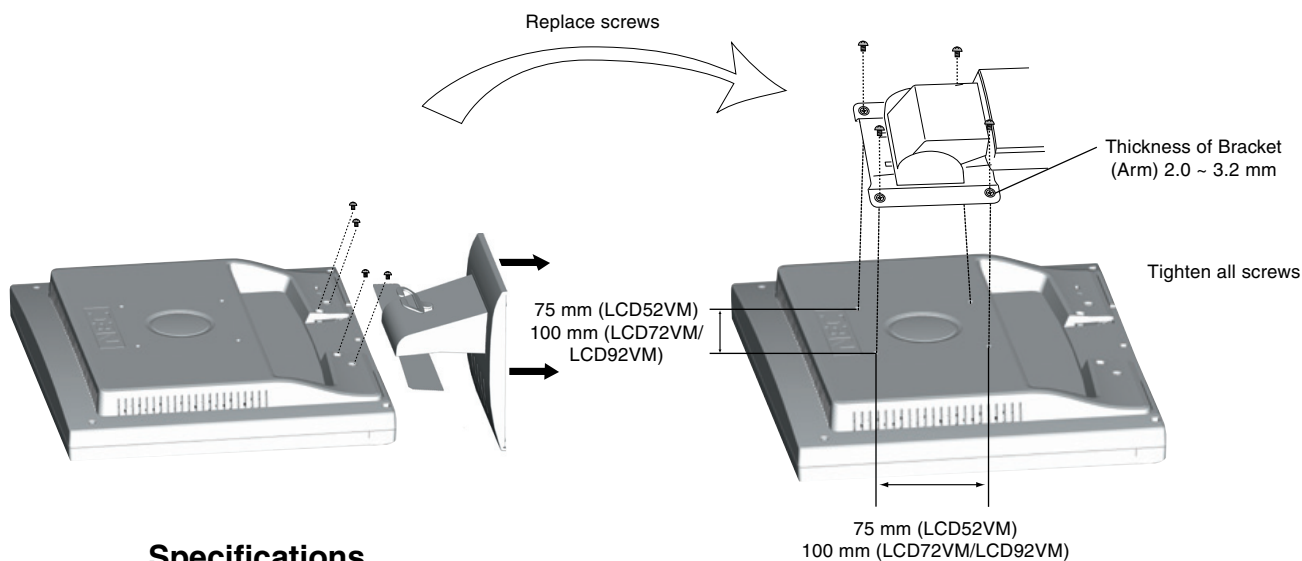

Specifications

4-SCREWS (M4)
(MAX depth: 8.5 mm)
If use other
screw, check
depth of hole.

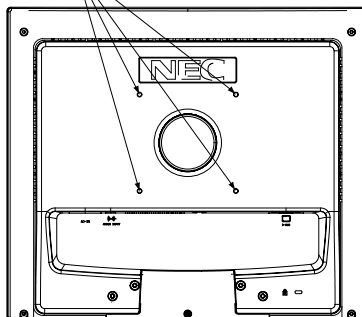

Weight of LCD assembly: 2.9 kg - LCD52VM (MAX)
4.3 kg - LCD72VM (MAX)
5.5 kg - LCD92VM (MAX)

Controls

OSM (On-Screen Manager) control buttons on the front of the monitor function as follows:

1. Basic function at pressing each key

Button	SELECT	-	+	AUTO / RESET
At No OSD showing	Showing OSM.	Shortcut to Bright adjust window.	Shortcut to Volume adjust window.	"Auto adjust" operate.
At OSD showing (Icon selection stage)	Go to Adjustment stage.	Cursor goes to left.	Cursor goes to right.	
At OSD showing (Adjustment stage)	Go to Icon selection stage.	Adjust value decrease or Cursor for adjust goes to left.	Adjust value increase or Cursor for adjust goes to right.	Reset operation. Mute off/on switch on Volume adjustment window.

2. OSM structure

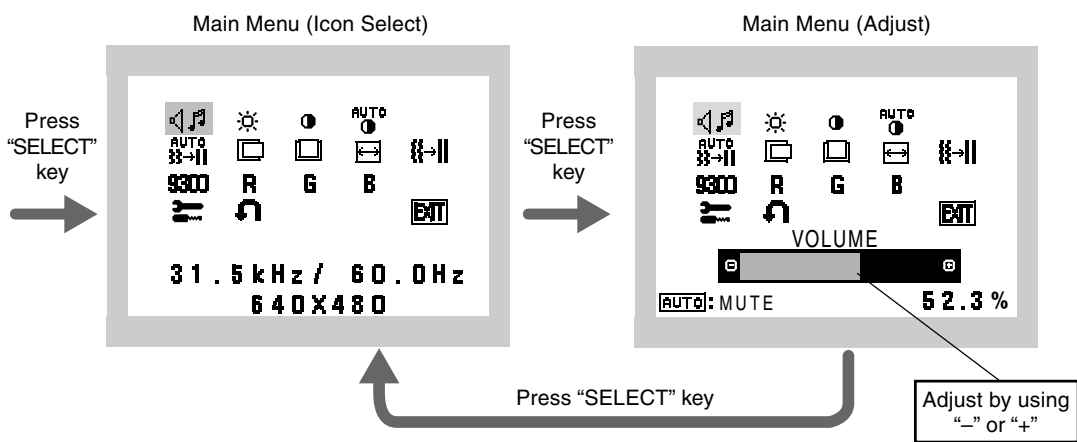

Example Tool:

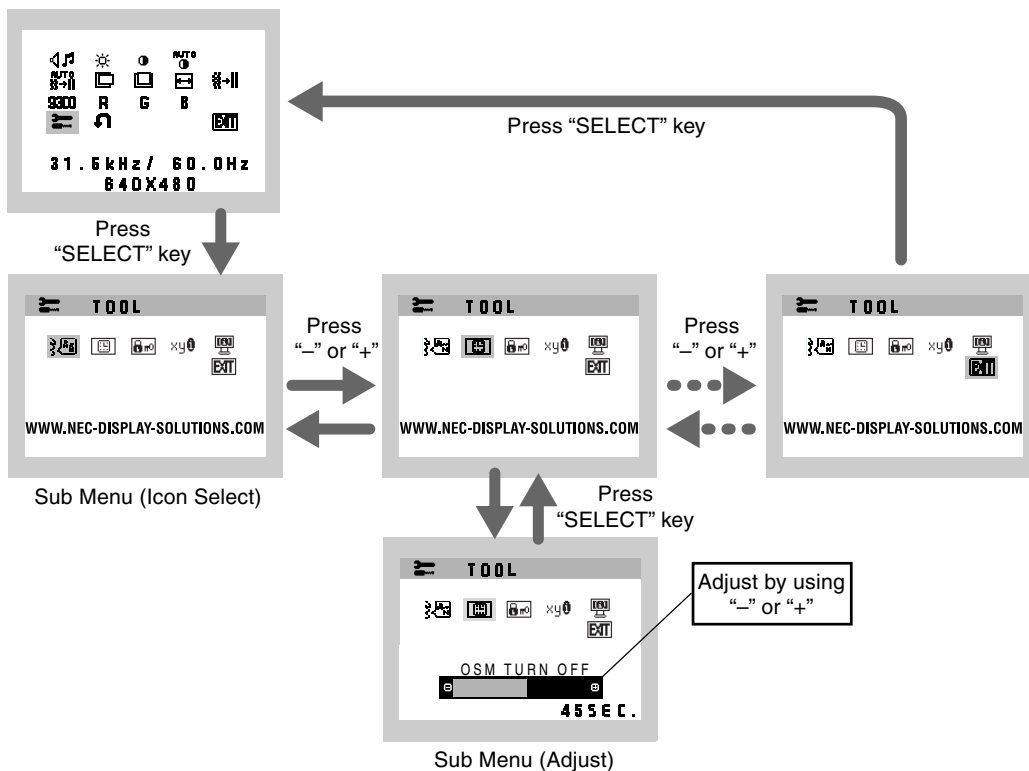

**AUDIO**

Audio volume icon is chosen, depending on the volume condition (AUTO/RESET).

**BRIGHTNESS**

Adjusts the overall image and background screen brightness.

**CONTRAST**

Adjusts the image brightness in relation to the background.

**AUTO CONTRAST**

Adjusts the image displayed for non-standard video inputs.

**AUTO ADJUST**

Automatically adjusts the Image Position, the H. Size and Fine setting.

**LEFT/RIGHT**

Controls Horizontal Image Position within the display area of the LCD.

**DOWN/UP**

Controls Vertical Image Position within the display area of the LCD.

**H. SIZE**

Adjusts the horizontal size by increasing or decreasing this setting.

**FINE**

Improves focus, clarity and image stability by increasing or decreasing this setting.

**COLOUR CONTROL SYSTEMS**

Four colour presets (9300/7500/6500/USER) select the desired colour setting.

**COLOUR RED**

Increase or decreases Red. The change will appear on screen.

**COLOUR GREEN**

Increase or decreases Green. The change will appear on screen.

**COLOUR BLUE**

Increase or decreases Blue. The change will appear on screen.

**TOOL**

Selecting TOOL allows you to get into the sub menu.

**FACTORY PRESET**

Selecting Factory Preset allows you to reset all OSM control settings back to the factory settings. The RESET button will need to be held down for several seconds to take effect. Individual settings can be reset by highlighting the control to be reset and pressing the RESET button.

**EXIT**

Selecting EXIT allows you exit OSM menu/ sub menu.

**LANGUAGE**

OSM control menus are available in seven languages.

**OSM TURN OFF**

The OSM control menu will stay on as long as it is in use. In the OSM Turn OFF submenu, you can select how long the monitor waits after the last touch of a button to shut off the OSM control menu. The preset choices are 10 - 120 seconds by 5 seconds step.



OSM LOCK OUT

This control completely locks out access to all OSM control functions without Brightness and Contrast. When attempting to activate OSM controls while in the Lock Out mode, a screen will appear indicating the OSM are locked out. To activate the OSM Lock Out function, press "AUTO/ RESET", then "+" key and hold down simultaneously. To de-activate the OSM Lock Out, press "AUTO/ RESET", then "+" key and hold down simultaneously.



RESOLUTION NOTIFIER

If ON is selected, a message will appear on the screen after 30 seconds, notifying you that the resolution is not at optimal resolution.



MONITOR INFO

Indicates the model and serial numbers of your monitor.

OSM Warning

OSM Warning menus disappear with Exit button.

NO SIGNAL: This function gives a warning when there is no signal present. After power is turned on or when there is a change of input signal or video is inactive, the **No Signal** window will appear.

RESOLUTION NOTIFIER: This function gives a warning of use with optimized resolution. After power is turned on or when there is a change of input signal or the video signal doesn't have proper resolution, the **Resolution Notifier** window will open. This function can be disabled in the TOOL menu.

OUT OF RANGE: This function gives a recommendation of the optimized resolution and refresh rate. After the power is turned on or there is a change of input signal or the video signal doesn't have proper timing, the **Out Of Range** menu will appear.

Recommended use

Safety Precautions and Maintenance



FOR OPTIMUM PERFORMANCE, PLEASE NOTE
THE FOLLOWING WHEN SETTING UP AND
USING THE ACCUSYNC LCD COLOUR MONITOR:



- **DO NOT OPEN THE MONITOR.** There are no user serviceable parts inside and opening or removing covers may expose you to dangerous shock hazards or other risks. Refer all servicing to qualified service personnel.
- Do not spill any liquids into the cabinet or use your monitor near water.
- Do not insert objects of any kind into the cabinet slots, as they may touch dangerous voltage points, which can be harmful or fatal or may cause electric shock, fire or equipment failure.
- Do not place any heavy objects on the power cord. Damage to the cord may cause shock or fire.
- Do not place this product on a sloping or unstable cart, stand or table, as the monitor may fall, causing serious damage to the monitor.
- When operating the LCD monitor with its AC 125-240V power supply, use a power supply cord that matches the power supply voltage of the AC power outlet being used. The power supply cord you use must have been approved by and comply with the safety standards of your country. (Type H05VV-F should be used in Europe).
- In U.K, use a BS-approved power cord with molded plug having a black (5A) fuse installed for use with this monitor. If a power cord is not supplied with this monitor, please contact your supplier.
- Do not place any objects onto the monitor and do not use the monitor outdoors.
- The inside of the fluorescent tube located within the LCD monitor contains mercury. Please follow the bylaws or rules of your municipality to dispose of the tube properly.
- Do not bend power cord.
- Do not use monitor in high temperature, humid, dusty, or oily areas.
- Do not cover vent on monitor.

Immediately unplug your monitor from the wall outlet and refer servicing to qualified service personnel under the following conditions:

- When the power supply cord or plug is damaged.
- If liquid has been spilled, or objects have fallen into the monitor.
- If the monitor has been exposed to rain or water.
- If the monitor has been dropped or the cabinet damaged.
- If the monitor does not operate normally by following operating instructions.
- If monitor is broken, do not come in contact with the liquid crystal and handle with care.



CAUTION

- Allow adequate ventilation around the monitor so that heat can properly dissipate. Do not block ventilated openings or place the monitor near a radiator or other heat sources. Do not put anything on top of monitor.
- The power cable connector is the primary means of detaching the system from the power supply. The monitor should be installed close to a power outlet, which is easily accessible.
- Handle with care when transporting. Save packaging for transporting.
- **Image Persistence:** Image persistence is when a residual or "ghost" image of a previous image remains visible on the screen. Unlike CRT monitors, LCD monitors' image persistence is not permanent, but constant images being displayed for a long period of time should be avoided. To alleviate image persistence, turn off the monitor for as long as the previous image was displayed. For example, if an image was on the monitor for one hour and a residual image remains, the monitor should be turned off for one hour to erase the image.

NOTE: As with all personal display devices, NEC DISPLAY SOLUTIONS recommends using a moving screen saver at regular intervals whenever the screen is idle or turning off the monitor when not in use.



CORRECT PLACEMENT AND ADJUSTMENT OF THE MONITOR CAN REDUCE EYE, SHOULDER AND NECK FATIGUE. CHECK THE FOLLOWING WHEN YOU POSITION THE MONITOR:



- For optimum performance, allow 20 minutes for warm-up.
- Adjust the monitor height so that the top of the screen is at or slightly below eye level. Your eyes should look slightly downward when viewing the middle of the screen.
- Position your monitor no closer than 40 cm and no further away than 70 cm from your eyes. The optimal distance is 50 cm.
- Rest your eyes periodically by focusing on an object at least 6 m away. Blink often.
- Position the monitor at a 90° angle to windows and other light sources to minimize glare and reflections. Adjust the monitor tilt so that ceiling lights do not reflect on your screen.
- If reflected light makes it hard for you to see your screen, use an antiglare filter.
- Clean the LCD monitor surface with a lint-free, non-abrasive cloth. Avoid using any cleaning solution or glass cleaner!
- Adjust the monitor's brightness and contrast controls to enhance readability.
- Use a document holder placed close to the screen.
- Position whatever you are looking at most of the time (the screen or reference material) directly in front of you to minimize turning your head while you are typing.
- Avoid displaying fixed patterns on the monitor for long periods of time to avoid image persistence (after-image effects).
- Get regular eye checkups.

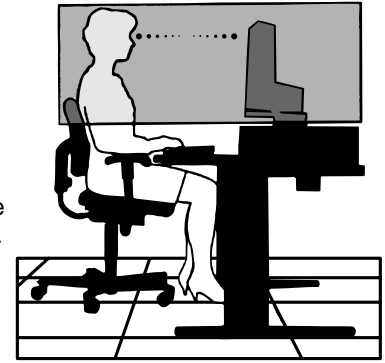

Ergonomics

To realize the maximum ergonomics benefits, we recommend the following:

- Use the preset Size and Position controls with standard signals.
- Use the preset Colour Setting.
- Use non-interlaced signals with a vertical refresh rate between 60-75 Hz.
- Do not use primary colour blue on a dark background, as it is difficult to see and may produce eye fatigue to insufficient contrast.

Specifications AccuSync LCD52VM Monitor

Monitor Specifications	AccuSync LCD52VM Monitor	Notes
LCD Module	Diagonal: 38 cm/15 inches Viewable Image Size: 38 cm/15 inches Native Resolution (Pixel Count): 1024 x 768	Active matrix; thin film transistor (TFT) liquid crystal display (LCD); 0.297 mm dot pitch; 250 cd/m ² white luminance, 400:1 contrast ratio, typical.
Input Signal	Video: ANALOG 0.7 Vp-p/75 Ohms Sync: Separate sync.TTL Level (Positive/Negative) Horizontal sync. Positive/Negative Vertical sync. Positive/Negative	
Display Colours	Analog input: 16,2 M	Depends on display card used.
Synchronization Range	Horizontal: 31.5 kHz to 61 kHz Vertical: 55 Hz to 76 Hz	Automatically Automatically
Viewing Angle	Left/Right: -60°/+60°(CR>10) Up/Down: -45°/+45°(CR>10)	
Resolutions Supported	Landscape: 720 x 400*1 : VGA 640 x 480*1 @ 60 Hz to 75 Hz 800 x 600*1 @ 56 Hz to 75 Hz 832 x 624*1 @ 75 Hz 1024 x 768 @ 60 Hz to 75 Hz.....	Some systems may not support all modes listed. Recommended resolution is 75 Hz for optimal display performance.
Active Display Area	Horizontal: 304.1 mm Vertical: 228.1 mm	
Speakers	Practical Audio Output: 1.0 W + 1.0 W	
Power Supply	100 - 240 V ~ 50/60 Hz	
Power Consumption	23 W	
Dimensions	Landscape: 344.6 mm (W) x 352.7 mm (H) x 165.0 mm (D) (with stand) 344.6 mm (W) x 285.0 mm (H) x 57.5 mm (D) (without stand)	
Weight	3.3 kg	
Environmental Considerations	Operating Temperature: 5 °C to 35 °C Humidity: 30% to 80% Altitude: 0 to 3,048 m Storage Temperature: -10 °C to +60 °C Humidity: 10% to 85% Altitude: 0 to 12,192 m	

*1 Interpolated Resolutions: When resolutions are shown that are lower than the pixel count of the LCD module, text may appear different. This is normal and necessary for all current flat panel technologies when displaying non-native resolutions full screen. In flat panel technologies, each dot on the screen is actually one pixel, so to expand resolutions to full screen, an interpolation of the resolution must be done.

NOTE: Technical specifications are subject to change without notice.

Specifications AccuSync LCD72VM Monitor

Monitor Specifications	AccuSync LCD72VM Monitor	Notes
LCD Module	Diagonal: 43 cm/17 inches Viewable Image Size: 43 cm/17 inches Native Resolution (Pixel Count): 1280 x 1024	Active matrix; thin film transistor (TFT) liquid crystal display (LCD); 0.264 mm dot pitch; 250 cd/m ² white luminance, 450:1 contrast ratio, typical.
Input Signal	Video: ANALOG 0.7 Vp-p/75 Ohms Sync: Separate sync.TTL Level (Positive/Negative) Horizontal sync. Positive/Negative Vertical sync. Positive/Negative	
Display Colours	Analog input: 16,2 M	Depends on display card used.
Synchronization Range	Horizontal: 31.5 kHz to 81.1 kHz Vertical: 55 Hz to 76 Hz	Automatically Automatically
Viewing Angle	Left/Right: -70°/+70°(CR>10) Up/Down: -65°/+60°(CR>10)	
Resolutions Supported	Landscape: 720 x 400*1 : VGA 640 x 480*1 @ 60 Hz to 75 Hz 800 x 600*1 @ 56 Hz to 75 Hz 832 x 624*1 @ 75 Hz 1024 x 768*1 @ 60 Hz to 75 Hz 1152 x 864*1 @ 70 Hz 1152 x 870*1 @ 75 Hz 1280 x 960*1 @ 60 Hz to 75 Hz 1280 x 1024 @ 60 Hz to 75 Hz.....	Some systems may not support all modes listed. Recommended resolution is 60 Hz for optimal display performance.
Active Display Area	Horizontal: 337.9 mm Vertical: 270.3 mm	
Speakers	Practical Audio Output: 1.0 W + 1.0 W	
Power Supply	100 - 240 V ~ 50/60 Hz	
Power Consumption	34 W	
Dimensions	Landscape: 375.4 mm (W) x 389.0 mm (H) x 180 mm (D) (with stand) 375.4 mm (W) x 326.5 mm (H) x 61 mm (D) (without stand)	
Weight	4.7 kg	
Environmental Considerations	Operating Temperature: 5 °C to 35 °C Humidity: 30% to 80% Altitude: 0 to 3,048 m Storage Temperature: -10 °C to +60 °C Humidity: 10% to 85% Altitude: 0 to 12,192 m	

*1 Interpolated Resolutions: When resolutions are shown that are lower than the pixel count of the LCD module, text may appear different. This is normal and necessary for all current flat panel technologies when displaying non-native resolutions full screen. In flat panel technologies, each dot on the screen is actually one pixel, so to expand resolutions to full screen, an interpolation of the resolution must be done.

NOTE: Technical specifications are subject to change without notice.

Specifications AccuSync LCD92VM Monitor

Monitor Specifications	AccuSync LCD92VM Monitor	Notes
LCD Module	Diagonal: 48.3 cm/19 inches Viewable Image Size: 48.3 cm/19 inches Native Resolution (Pixel Count): 1280 x 1024	Active matrix; thin film transistor (TFT) liquid crystal display (LCD); 0.294 mm dot pitch; 250 cd/m ² white luminance, 450:1 contrast ratio, typical.
Input Signal	Video: ANALOG 0.7 Vp-p/75 Ohms Sync: Separate sync.TTL Level (Positive/Negative) Horizontal sync. Positive/Negative Vertical sync. Positive/Negative	
Display Colours	Analog input: 16,2 M	Depends on display card used.
Synchronization Range	Horizontal: 31.5 kHz to 81.1 kHz Vertical: 55 Hz to 76 Hz	Automatically Automatically
Viewing Angle	Left/Right: -65°/+65°(CR>10) Up/Down: -65°/+65°(CR>10)	
Resolutions Supported	Landscape: 720 x 400*1 : VGA 640 x 480*1 @ 60 Hz to 75 Hz 800 x 600*1 @ 56 Hz to 75 Hz 832 x 624*1 @ 75 Hz 1024 x 768*1 @ 60 Hz to 75 Hz 1152 x 864*1 @ 70 Hz 1152 x 870*1 @ 75 Hz 1280 x 960*1 @ 75 Hz 1280 x 1024 @ 60 Hz to 75 Hz.....	Some systems may not support all modes listed. Recommended resolution is 60 Hz for optimal display performance.
Active Display Area	Horizontal: 376.3 mm Vertical: 301.1 mm	
Speakers	Practical Audio Output: 1.0 W + 1.0 W	
Power Supply	100 - 240 V ~ 50/60 Hz	
Power Consumption	40 W	
Dimensions	Landscape: 418 mm (W) x 427.8 mm (H) x 199.5 mm (D) (with stand) 418 mm (W) x 369.8 mm (H) x 68 mm (D) (without stand)	
Weight	6.5 kg	
Environmental Considerations	Operating Temperature: 5 °C to 35 °C Humidity: 30% to 80% Altitude: 0 to 3,048 m Storage Temperature: -10 °C to +60 °C Humidity: 10% to 85% Altitude: 0 to 12,192 m	

*1 Interpolated Resolutions: When resolutions are shown that are lower than the pixel count of the LCD module, text may appear different. This is normal and necessary for all current flat panel technologies when displaying non-native resolutions full screen. In flat panel technologies, each dot on the screen is actually one pixel, so to expand resolutions to full screen, an interpolation of the resolution must be done.

NOTE: Technical specifications are subject to change without notice.

Features

Reduced Footprint: Provides the ideal solution for environments requiring superior image quality but with size and weight limitations. The small footprint and low weight allow it to be moved or transported easily from one location to another.

AccuColor Control Systems: Allows you to adjust the colours on your screen and customize the colour accuracy of your monitor to a variety of standards.

OSM (On-Screen Manager) Controls: Allow you to quickly and easily adjust all elements of your screen image via simple to use on-screen menus.

No-touch Auto Adjust: No-touch Auto Adjust automatically adjusts the monitor to optimal settings upon initial setup.

ErgoDesign Features: Enhance human ergonomics to improve the working environment, protect the health of the user and save money. Examples include OSM controls for quick and easy image adjustments, tilt base for preferred angle of vision, small footprint and compliance with MPRII and TCO guidelines for lower emissions.

Plug and Play: The Microsoft solution with the Windows 95/98/Me/2000/XP operating system facilitates setup and installation by allowing the monitor to send its capabilities (such as screen size and resolutions supported) directly to your computer, automatically optimizing display performance.

IPM (Intelligent Power Manager) System: Provides innovative power-saving methods that allow the monitor to shift to a lower power consumption level when on but not in use, saving two-thirds of your monitor energy costs, reducing emissions and lowering the air conditioning costs of the workplace.

Multiple Frequency Technology: Automatically adjusts monitor to the display card's scanning frequency, thus displaying the resolution required.

FullScan Capability: Allows you to use the entire screen area in most resolutions, significantly expanding image size.

VESA Standard Mounting Interface: Allows users to connect their AccuSync monitor to any VESA standard third party mounting arm or bracket. Allows for the monitor to be mounted on a wall or an arm using any third party compliant device.

Troubleshooting

No picture

- The signal cable should be completely connected to the display card/computer.
- The display card should be completely seated in its slot.
- Check front power Switch and computer power switch should be in the ON position.
- Check to make sure that a supported mode has been selected on the display card or system being used. (Please consult display card or system manual to change graphics mode.)
- Check the monitor and your display card with respect to compatibility and recommended settings.
- Check the signal cable connector for bent or pushed-in pins.
- Check the signal input.

Power Button does not respond

- Unplug the power cord of the monitor from the AC outlet to turn off and reset the monitor.

Image persistence

- Image persistence is when a “ghost” of an image remains on the screen even after the monitor has been turned off. Unlike CRT monitors, LCD monitors’ image persistence is not permanent, but constant images being displayed for a long period of time should be avoided.
To alleviate image persistence, turn the monitor off for as long as an image was displayed. For example, if an image was on the monitor for one hour and a residual image remains, the monitor should be turned off for one hour to erase the image.

NOTE: As with all personal display devices, NEC DISPLAY SOLUTIONS recommends using a screen saver at regular intervals whenever the screen is idle or turning off the monitor when not in use.

Image is unstable, unfocused or swimming is apparent

- Signal cable should be completely attached to the computer.
- Use the OSM Image Adjust controls to focus and adjust display by increasing or decreasing the fine total. When the display mode is changed, the OSM Image Adjust settings may need to be re-adjusted.
- Check the monitor and your display card with respect to compatibility and recommended signal timings.
- If your text is garbled, change the video mode to non-interlace and use 60 Hz refresh rate.

LED on monitor is not lit (no green or amber colour can be seen)

- Power Switch should be in the ON position and power cord should be connected.

Display image is not sized properly

- Use the OSM Image Adjust controls to increase or decrease the H.SIZE.
- Check to make sure that a supported mode has been selected on the display card or system being used. (Please consult display card or system manual to change graphics mode.)

No Video

- If no video is present on the screen, turn the Power button off and on again.
- Make certain the computer is not in a power-saving mode (touch the keyboard or mouse).

No Sound

- Check to see if speaker cable is properly connected.
- Check to see if mute is activated.
- Check to see if volume in OSM is set at minimum.

Congratulations! You have just purchased a TCO'99 approved and labelled product! Your choice has provided you with a product developed for professional use. Your purchase has also contributed to reducing the burden on the environment and also to the further development of environmentally adapted electronics products.



Why do we have environmentally labelled computers?

In many countries, environmental labelling has become an established method for encouraging the adaptation of goods and services to the environment. The main problem, as far as computers and other electronics equipment are concerned, is that environmentally harmful substances are used both in the products and during the manufacturing. Since it has not been possible for the majority of electronics equipment to be recycled in a satisfactory way, most of these potentially damaging substances sooner or later enter Nature.

There are also other characteristics of a computer, such as energy consumption levels, that are important from the viewpoints of both the work (Internal) and natural (external) environments. Since all methods of conventional electricity generation have a negative effect on the environment (acidic and climate-influencing emissions, radioactive waste, etc.), it is vital to conserve energy. Electronics equipment in offices consume an enormous amount of energy since they are often left running continuously.

What does labelling involve?

This product meets the requirements for the TCO'99 scheme which provides for international and environmental labelling of personal computers. The labelling scheme was developed as a joint effort by the TCO (The Swedish Confederation of Professional Employees), Svenska Naturskyddsforeningen (The Swedish Society for Nature Conservation) and Statens Energimyndighet (The Swedish National Energy Administration).

The requirements cover a wide range of issues: environment, ergonomics, usability, emission of electrical and magnetic fields, energy consumption and electrical and fire safety.

The environmental demands concern restrictions on the presence and use of heavy metals, brominated and chlorinated flame retardants, CFCs (freons) and chlorinated solvents, among other things. The product must be prepared for recycling and the manufacturer is obliged to have an environmental plan which must be adhered to in each country where the company implements its operational policy. The energy requirements include a demand that the computer and/or display, after a certain period of inactivity, shall reduce its power consumption to a lower level in one or more stages. The length of time to reactivate the computer shall be reasonable for the user.

Labelled products must meet strict environmental demands, for example, in respect of the reduction of electric and magnetic fields, physical and visual ergonomics and good usability.

Environmental Requirements

Flame retardants

Flame retardants are present in printed circuit boards, cables, wires, casings and housings. In turn, they delay the spread of fire. Up to thirty percent of the plastic in a computer casing can consist of flame retardant substances. Most flame retardants contain bromine or chloride and these are related to another group of environmental toxins, PCBs, which are suspected to give rise to severe health effects, including reproductive damage in fish-eating birds and mammals, due to the bioaccumulative* processes. Flame retardants have been found in human blood and researchers fear that disturbances in foetus development may occur.

TCO'99 demand requires that plastic components weighing more than 25 grams must not contain flame retardants with organically bound chlorine and bromine. Flame retardants are allowed in the printed circuit boards since no substitutes are available.

Lead**

Lead can be found in picture tubes, display screens, solders and capacitors. Lead damages the nervous system and in higher doses, causes lead poisoning.

TCO'99 requirement permits the inclusion of lead since no replacement has yet been developed.

Cadmium**

Cadmium is present in rechargeable batteries and in the colourgenerating layers of certain computer displays. Cadmium damages the nervous system and is toxic in high doses.

TCO'99 requirement states that batteries, the colourgenerating layers of display screens and the electrical or electronics components must not contain any cadmium.

Mercury**

Mercury is sometimes found in batteries, relays and switches. Mercury damages the nervous system and is toxic in high doses.

TCO'99 requirement states that batteries may not contain any Mercury. It also demands that no mercury is present in any of the electrical or electronics components associated with the display unit.

CFCs (freons)

CFCs (freons) are sometimes used for washing printed circuit boards. CFCs break down ozone and thereby damage the ozone layer in the stratosphere, causing increased reception on Earth of ultraviolet light with consequent increased risks of skin cancer (malignant melanoma).

The relevant TCO'99 requirement; Neither CFCs nor HCFCs may be used during the manufacturing and assembly of the product or its packaging.

*Bio-accumulative is defined as substances which accumulate within living organisms.

**Lead, Cadmium and Mercury are heavy metals which are Bio-accumulative.

To obtain complete information on the environmental criteria document, order from:

TCO Development Unit

SE-114 94 Stockholm

SWEDEN

FAX Number: +46 8 782 92 07

E-mail (Internet): development@tco.se

You may also obtain current information on TCO'99 approved and labelled products by visiting their website at: <http://www.tcodevelopment.com>

Disposing of your old NEC product

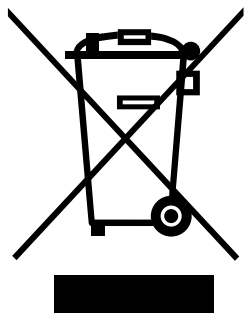

Within the European Union

EU-wide legislation, as implemented in each Member State, requires that waste electrical and electronic products carrying the mark (left) must be disposed of separately from normal household waste. This includes monitors and electrical accessories, such as signal cables or power cords. When you need to dispose of your NEC display products, please follow the guidance of your local authority, or ask the shop where you purchased the product, or if applicable, follow any agreements made between yourself and NEC.

The mark on electrical and electronic products only applies to the current European Union Member States.

Outside the European Union

If you wish to dispose of used electrical and electronic products outside the European Union, please contact your local authority so as to comply with the correct disposal method.