

Compact Disc Player

Operating Instructions



CDP-CX455

WARNING

To reduce the risk of fire or electric shock, do not expose this apparatus to rain or moisture.

To avoid electrical shock, do not open the cabinet. Refer servicing to qualified personnel only.

For the customers in the United States

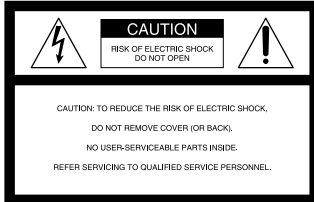

This symbol is intended to alert the user to the presence of uninsulated “dangerous voltage” within the product’s enclosure that may be of sufficient magnitude to constitute a risk of electric shock to persons.



This symbol is intended to alert the user to the presence of important operating and maintenance (servicing) instructions in the literature accompanying the appliance.

WARNING

This equipment has been tested and found to comply with the limits for a Class B digital device, pursuant to Part 15 of the FCC Rules. These limits are designed to provide reasonable protection against harmful interference in a residential installation. This equipment generates, uses, and can radiate radio frequency energy and, if not installed and used in accordance with the instructions, may cause harmful interference to radio communications. However, there is no guarantee that interference will not occur in a particular installation. If this equipment does cause harmful interference to radio or television reception, which can be determined by turning the equipment off and on, the user is encouraged to try to correct the interference by one or more of the following measures:

- Reorient or relocate the receiving antenna.
- Increase the separation between the equipment and receiver.
- Connect the equipment into an outlet on a circuit different from that to which the receiver is connected.
- Consult the dealer or an experienced radio/TV technician for help.

CAUTION

You are cautioned that any changes or modifications not expressly approved in this manual could void your authority to operate this equipment.

Owner’s Record

The model and serial numbers are located on the rear of the unit. Record the serial number in the space provided below. Refer to them whenever you call upon your Sony dealer regarding this product.

Model No. CDP-CX455

Serial No. _____

Welcome!

Thank you for purchasing this Sony Compact Disc Player. Before operating the unit, please read this manual thoroughly and retain it for future reference.

About This Manual

The instructions in this manual are for model CDP-CX455.

Conventions

- Instructions in this manual describe the controls on the player. You can also use the controls on the remote if they have the same or similar names as those on the player.
- The following icons are used in this manual:



Indicates that you can do the task using the remote.



Indicates hints and tips for making the task easier.

Notes on CDs

On handling CDs

- To keep the disc clean, handle the disc carefully.
- Do not stick paper or tape on the disc.

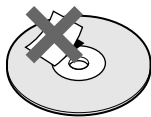
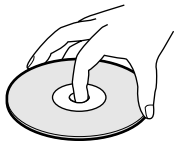

- Do not expose the disc to direct sunlight or heat sources such as hot air ducts, nor leave it in a car parked in direct sunlight as there can be considerable rise in temperature inside the car.
- After removing a disc from the disc slot, store the disc in its case.

On cleaning

- Before playing, clean the disc with a cleaning cloth. Wipe the disc from the center out.

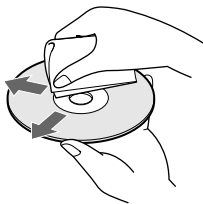

- Do not use solvents such as benzene, thinner, commercially available cleaners or anti-static spray intended for vinyl LPs.

Notes on CD-R and CD-RW discs

This unit can play the following discs:

Type of discs	Label on the disc
Audio CD	
MP3 files	

- Some CD-Rs/CD-RWs (depending on the equipment used for their recording or the condition of the disc) may not play on this player.
- You cannot play a CD-R/CD-RW that is not finalized*.

* A process necessary for a recorded CD-R/CD-RW disc to be played on the audio CD player.

About MP3 files

MP3 (MPEG 1 Audio Layer-3) is a standard technology and format for compressing a sound sequence. The file is compressed to about 1/10 of its original size. Sounds outside the range of human hearing are compressed while the sounds we can hear are not compressed. Playback of some MP3 files may not be possible, depending on the encoding.

The encoding method (i.e., the bit rate selected for encoding) will affect the sound quality of the MP3 files created. The bit rate typically used for MP3 files is 128 kbps.

Notes on discs

You can play MP3 files recorded on CD-ROMs, CD-Rs (recordable CDs), and CD-RWs (rewritable CDs). The disc must be in the ISO 9660*¹ level 1 or level 2 format, or Joliet or Romeo in the expansion format. You can use a disc recorded in Multi Session*².

(continued)

*1 ISO 9660 Format

The most common international standard for the logical format of files and folders on a CD-ROM. There are several specification levels. In Level 1, file names must be in the 8.3 format (no more than eight characters in the name, no more than three characters in the extension “.MP3”) and in capital letters. Folder names can be no longer than eight characters. There can be no more than eight nested folder levels. Level 2 specifications allow file names up to 31 characters long.

Each folder can have up to 8 trees.

For Joliet or Romeo in the expansion format, make sure of the contents of the writing software, etc.

*2 Multi Session

This is a recording method that enables adding of data using the Track-At-Once method. Conventional CDs begin at a CD control area called the Lead-in and end at an area called Lead-out. A Multi Session CD is a CD having multiple sessions, with each segment from Lead-in to Lead-out regarded as a single session.

CD-EXTRA: A format in which CD-DA (audio) data are recorded in the tracks of session 1 and computer data in the tracks of session 2.

Mixed CD: A format in which computer data are recorded in the first track and CD-DA (audio) data in the following tracks within a session.

Notes

- With formats other than ISO 9660 level 1, folder names or file names may not be displayed correctly.
- When naming, be sure to add the file extension “.MP3” to the file name.
- If you up the extension “.MP3” to a file other than MP3, the unit cannot recognize the file properly and will generate random noise that could damage your speakers.
- The following discs take a longer time to start playback.
 - a disc recorded with complicated tree structure.
 - a disc recorded in Multi Session.
 - a disc to which data can be added (non-finalized disc).

Cautions when playing a disc that is recorded in Multi Session

CD-DA (audio) data or MP3 files stored on a Multi Session CD may be subject to some restrictions on playback.

- If the disc begins with a CD-DA session, it is recognized as a CD-DA (audio) disc, and playback continues until an MP3 session is encountered.
- If the disc begins with an MP3 session, it is recognized as an MP3 disc, and playback continues until a CD-DA (audio) session is encountered.
- The playback range of an MP3 disc is determined by the tree structure of files produced by analyzing of the disc.
- A disc with a mixed CD format will be recognized as a CD-DA (audio) disc.

The playback order of the MP3 files

The playback order of the folders and files is as follows:

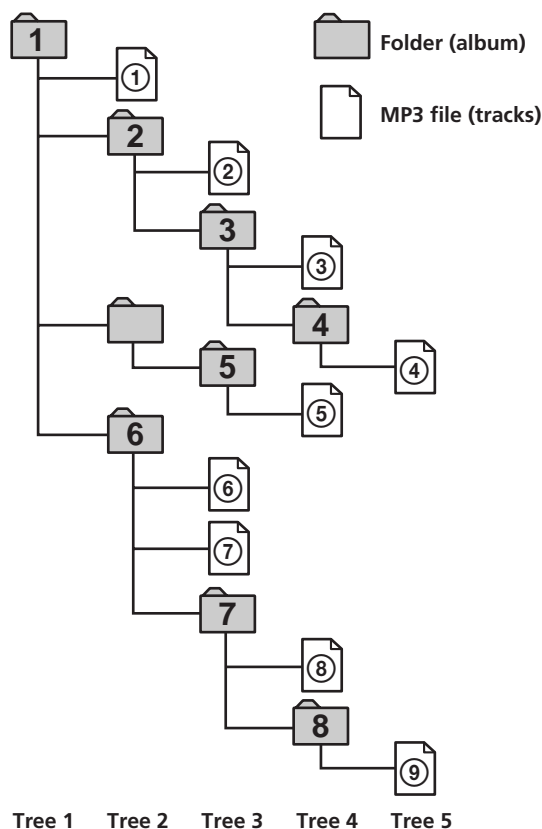

Notes

- A folder that does not include an MP3 file is skipped.
- When you insert a disc with many trees, it takes a longer time to start playback.

We recommend that you make only one or two trees for each disc.
- Maximum folder number: 150 (including root folder and empty folders)
- Maximum total number of MP3 files and folders: 300
- The CD player can play the MP3 files in a folder whose depth in the folder tree is up to 8.

Tip

To specify a desired playback order, before the folder or file name, input the order by number (e.g., “01”, “02”), then record contents onto a disc. (The order differs depending on the writing software.)

Note on playback of MP3 files

Depending on the encoding/writing software, recording device, or the recording media used at the time an MP3 file is recorded, you may encounter such problems as disabled playback, sound interruptions, and noise.

TABLE OF CONTENTS

Getting Started

Unpacking	6
Hooking Up the System	6
Connecting Another CD Player	8
Inserting CDs	9

Playing CDs

Playing a CD	12
Using the Display	13
Locating a Specific Disc	15
Specifying the Next Disc to Play	17
Playing Discs (Album) in Various Modes (Repeat/Shuffle Play)	17
Creating Your Own Program (Program Play)	19
Using the Timer	22
Fading In or Out	22

Storing Information About CDs (Custom Files)

What You Can Do With the Custom Files	23
Labeling Discs (Disc Name)	23
Storing Custom File Information Using a Keyboard	26
Classifying Discs According to Artist Name (Artist File)	27
Playing discs assigned the same Artist Name with one-touch of a TOP ARTIST button (Top Artist Play)	29

Using the Player with Another Component

Controlling Another CD Player (Advanced Mega Control)	30
Playing Alternately (No-Delay Play/X-Fade Play)	31
Controlling the Player by Another Unit	32

Additional Information

Using the CONTROL A1II control system	33
Precautions	34
Troubleshooting	35
Specifications	36

Index

Index	37
-------------	----

Unpacking

Check that you received the following items:

- Audio cord (1)
- Monaural (2P) mini-plug cord (1) (Connecting cord for CONTROL A1II) (supplied for Canadian models only)
- Remote commander (remote) (1)
- Size AA (LR6) batteries (2)

Inserting batteries into the remote

You can control the player using the supplied remote. Insert two size AA (LR6) batteries (supplied) by matching the + and – ends on the batteries to the diagram inside the battery compartment. Insert the negative (–) end first, then push in and down until the positive (+) end clicks into position. When using the remote, point it at the remote sensor  on the player.

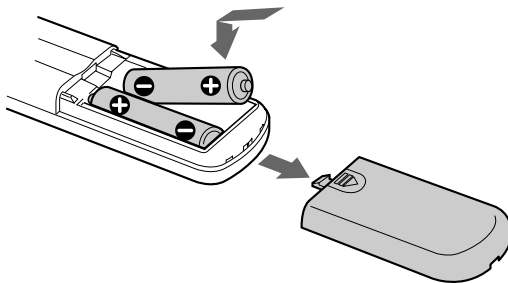

When to replace batteries

With normal use, the batteries should last for about six months. When the remote no longer operates the player, replace all the batteries with new ones.

Notes

- Do not leave the remote near an extremely hot or humid place.
- Do not drop any foreign object into the remote casing, particularly when replacing the batteries.
- Do not expose the remote sensor to direct sunlight or leave too near lighting apparatuses. Doing so may cause a malfunction.
- If you do not use the remote for an extended period of time, remove the batteries to avoid possible damage from battery leakage and corrosion.

Hooking Up the System

Overview

This section describes how to hook up the CD player to an amplifier. Be sure to turn off the power of each component before making the connections.

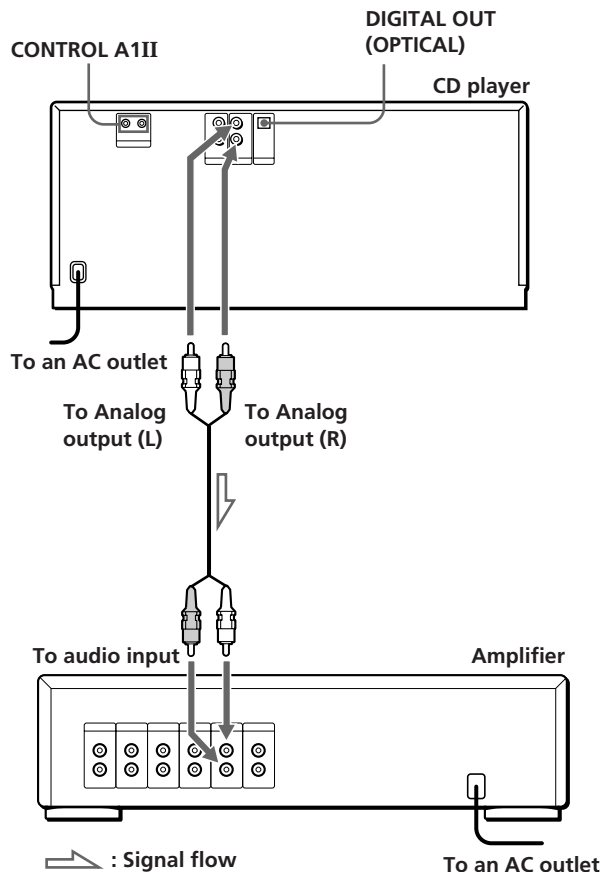

What cords will I need?

Audio cord (supplied) (1)

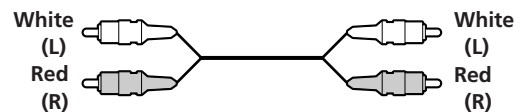

Hookups

When connecting an audio cord, be sure to match the color-coded cord to the appropriate jacks on the components: Red (right) to Red and White (left) to White. Be sure to connect firmly to avoid hum and noise.

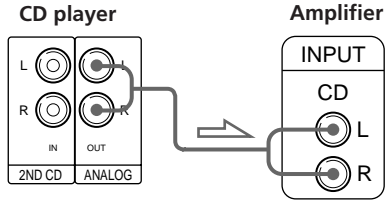

- **If you have a digital component such as a digital amplifier, D/A converter, DAT, or MD**
Connect the component via the DIGITAL OUT (OPTICAL) connector using an optical cable (not supplied). Take off the cap and plug in the optical cable.
Note that you cannot use fading in or out (page 22).

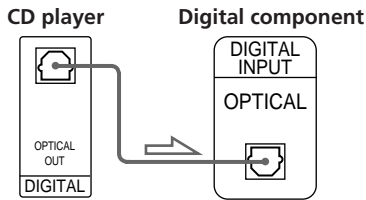
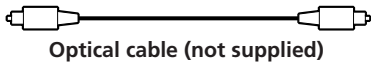

Notes

- The playback from an MP3 file is not output from the DIGITAL OUT (OPTICAL) connector.
- When you connect via the DIGITAL OUT (OPTICAL) connector, noise may occur when you play CD software other than music, such as a CD-ROM.



If you have a Sony component with the CONTROL A1II (or CONTROL A1) jack

Connect the component via the CONTROL A1II (or CONTROL A1) jack. You can simplify the operations of audio systems composed of separate Sony components. For details, see "Using the CONTROL A1II Control System" on page 33.

Connecting the AC power cord

Connect the AC power cord to a wall outlet.

Note on placement of the player

Be sure to place the player on a flat, horizontal place. If the player is left on a slanted position, it may cause a malfunction or damage the player.

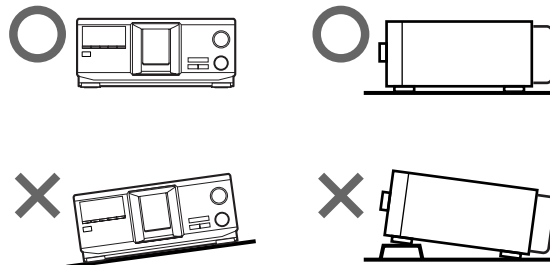

Connecting Another CD Player

If you have a Sony CD player in which 5, 50, 200, 300, or 400 discs can be inserted and which is equipped with the CONTROL A1II (or CONTROL A1) jack and the command mode of that player can be set to CD3, you can control that player as the second player with this player. After connecting this player and an amplifier, follow the procedure below. Be sure to turn off the power of each player before making this connection.

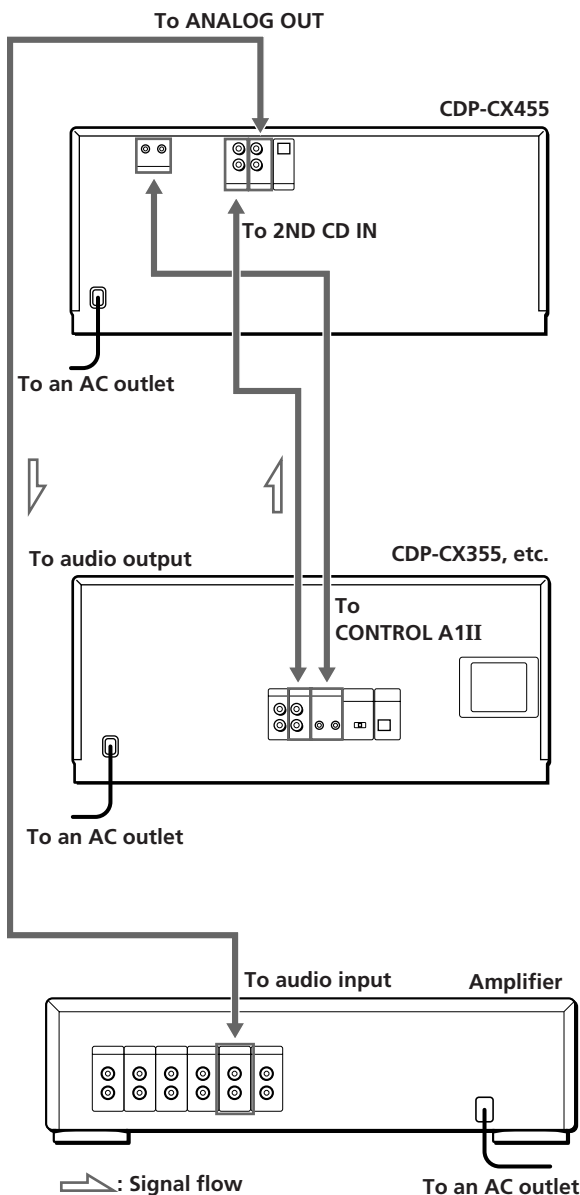

What cords will I need?

- Audio cord (1) (Use the cord supplied with the player to be connected.)
- Monaural (2P) mini-plug cord (1) (supplied for Canadian models only)

- 1 Connect the players with an audio cord (see also "Hookups" on page 6).

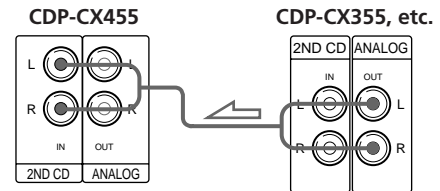

- 2 Connect the players with a monaural (2P) mini-plug cord.

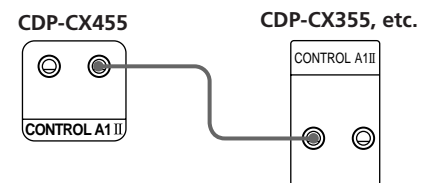

For details on this connection, see "Using the CONTROL A1II Control System" on page 33.

- 3 Set the command mode of this player to CD1 (factory setting) or CD2, and set that of the second player to CD3. Check the display for the current command mode of this player, if the mode is CD3, change the mode as described on the next page.

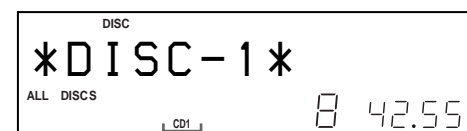

Current command mode

For details on how to operate the second player, see "Controlling Another CD Player" on page 30 and "Playing Alternately" on page 31.

- 4 Connect the AC power cord of both players to an AC outlet.

Notes

- Do not connect any player other than the one used as the second player to the 2ND CD IN jacks of this player.
- When connecting a second CD player, do not connect the DIGITAL OUT (OPTICAL) connector of this player to the amplifier.

Changing the command mode of the player

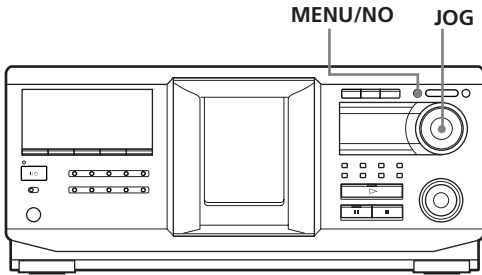

- 1** Press MENU/NO.
- 2** Turn the JOG dial until "COMMAND MODE?" appears in the display.
- 3** Push the JOG dial.
The current command mode appears.

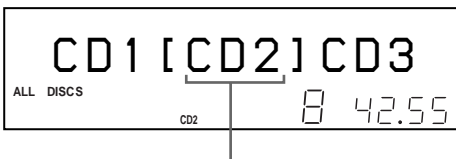

Current command mode

- 4** Turn the JOG dial to select CD1 or CD2, then push the JOG dial again.

Inserting CDs

You can insert up to 400 discs into this player.

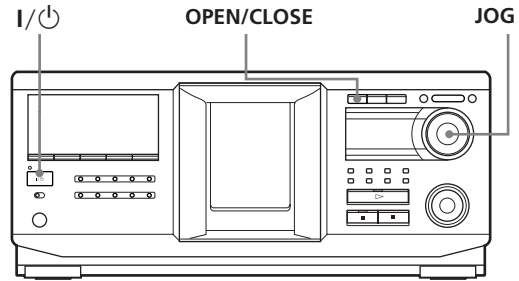

Top view of the disc slot

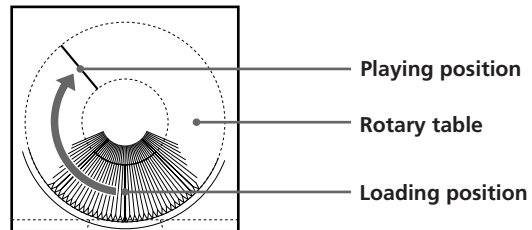

- 1** Press I/POWER to turn on the player.
- 2** Open the front cover by pressing OPEN/CLOSE.

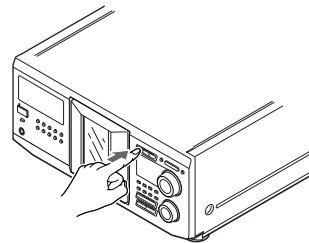

- 3** Turn the JOG dial until you find the disc slot where you want to insert a disc, while checking the disc number (written beside every slot and also indicated in the small display).

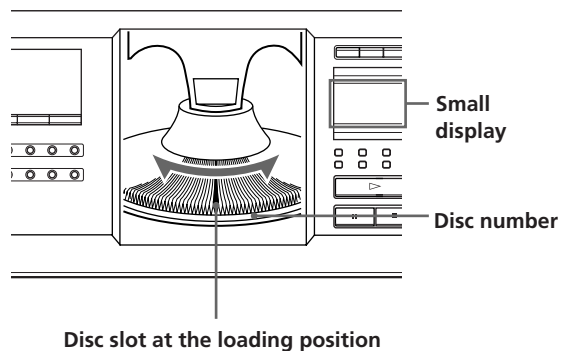

(continued)

The disc number at the loading position appears in the display. If the disc has a Disc Name (see page 23), the Disc Name appears instead of the disc number. As you turn the JOG dial, the disc number or the Disc Name changes.

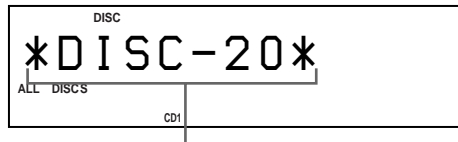

Disc number or the Disc Name

You can classify discs by using the Artist Name function. This feature lets you easily find the disc you want to play. For details, see "Classifying Discs According to Artist Name (Artist File)" on page 27.

- 4 Insert a disc with the label side facing right.

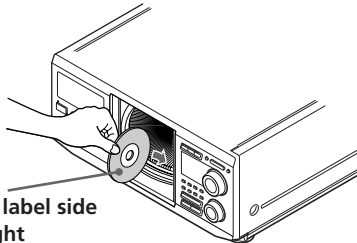

With the label side facing right

After inserting the disc, you can enter the original disc title to replace the disc number (see "Labeling discs (Disc Name)" on page 23) so you can locate it easily whenever you want to play it.



- 5 Repeat steps 3 and 4 to insert more discs.
- 6 Close the front cover by pressing OPEN/CLOSE.

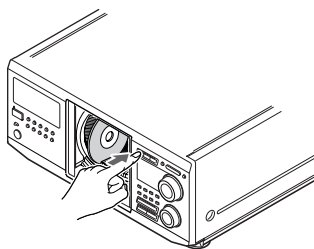

The rotary table turns and the disc slot at the loading position is set to the playing position. Always keep the front cover closed except when inserting or removing discs.

CAUTION

- **Do not insert an 8 cm (3-inch) CD adaptor.**

The player cannot play an 8 cm CD. Do not insert an 8 cm (3-inch) CD or an 8 cm (3-inch) CD adaptor (CSA-8). It may damage the player and disc.

- **Do not move the player after inserting discs.**



- Be sure to place the player in a flat, horizontal position. Do not place the player in a slanted position.



- Do not move the player and avoid any physical shock after inserting discs.

- When transporting the player, remove all discs from the player.

- **Make sure to insert the disc at a right angle to the rotary table.**

If the disc is not inserted into the slot completely (ex. when you press ) , reinsert the disc at a right angle to the rotary table (or press  again).

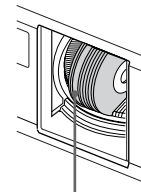



Disc that is not fully inserted

- **Do not attach seals or stickers, etc. to CDs.**

If seals or stickers, etc. are attached to a CD, the player may not operate properly and the player or the disc may be damaged.

Notes



- If you drop a disc into the player and/or the CD does not go into the slot correctly, consult your nearest Sony dealer.
- Make sure the rotary table comes to a complete stop before inserting or removing discs.
- The front cover closes automatically when you press . Be careful not to put your hand into the player after pressing , otherwise your hand may be caught in the front cover.

Removing CDs

After following steps 1 to 3 of “Inserting CDs” on page 9, remove the discs. Then close the front cover.



To remove discs easily

After following steps 1 to 3 of “Inserting CDs” on page 9, press  (DISC EJECT). The disc in the selected slot moves up and you can remove the disc easily. When you press  again, the disc returns to the loaded position. If the disc does not return to the loaded position, reinsert the disc.

Playing a CD

You can play all the tracks or MP3 files on a disc in the original order (Continuous Play). You can also play up to 400 discs consecutively. Make sure you have inserted the discs correctly as indicated on pages 9 and 10.

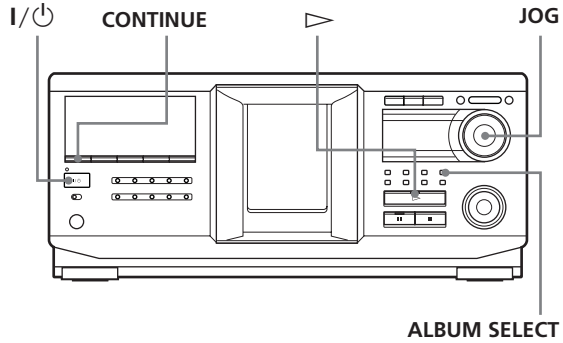

- 1 Turn on the amplifier and select the CD playing position.
- 2 Press I/⏻ to turn on the player.
- 3 Press CONTINUE to select ALL DISCS, 1 DISC, or ALBUM Continuous Play mode. Each time you press CONTINUE, "ALL DISCS", "1 DISC", or "ALBUM" appears alternately in the display. Be sure to stop playback before you change the play mode with CONTINUE, SHUFFLE, or PROGRAM.

When you select The player plays

ALL DISCS	All discs in the player consecutively in the order of disc number. Empty disc slots are skipped.
1 DISC	Only the one disc you have selected.
ALBUM*	Only the one album.

* When a disc that contains no albums is played with "ALBUM" selected, the disc is played in the same way as when "1 DISC Continuous Play" mode is selected.

- 4 Make sure the ALBUM SELECT button is off, then turn the JOG dial until the desired disc number or Disc Name (see page 23) appears in the display to select the first disc (ALL DISCS) or the disc you want (1 DISC).

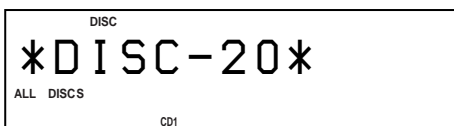





About the ALBUM SELECT button



While the button is off: The JOG dial selects discs.

While the button lights up: The JOG dial selects albums.

- 5 To play audio tracks, skip this step and go to step 7.
- 6 To select an album, press the ALBUM SELECT button to cause it to light up, and then turn the JOG dial until the desired album name appears in the display. Turn clockwise to select next album and turn counterclockwise to select preceding album.
- 7 Push the JOG dial to start playing and adjust the volume on the amplifier. The selected disc is set to the playing position, and the player plays all the discs from the selected one (ALL DISCS), all the tracks once (1 DISC), or all the MP3 files in the selected album once (ALBUM).

Operations you may want to do during play

To	Do this
Stop playback	Press ■.
Pause	Press ■■.
Resume playing after pause	Press ■■ or ▷.
Go to the next disc 	Press DISC + once. Hold down the button to skip other discs.
Go back to the preceding disc 	Press DISC - once. Hold down the button to skip other discs.
Go to the next album 	Press ALBUM +.
Go back to the preceding album 	Press ALBUM -.

To	Do this
Go to a specific track directly 	Press the number button of the track on the remote. When you directly locate a track numbered over 10, press >10 first, then the corresponding number buttons. Examples: <ul style="list-style-type: none"> To select track number 30 on a CD recorded with 50 tracks, press >10, then 3 and 10/0. To select track number 30 on a CD recorded with 200 tracks, press >10, then 10/0, 3 and 10/0.
Go to a point in a track while monitoring the sound 	Press ◀◀ (backward)/▶▶ (forward) on the remote and hold down until you find the point.
Go to a point in a track by observing the display 	Press ◀◀ (backward)/▶▶ (forward) on the remote and hold down until you find the point during pause. You will not hear the sound during the operation.
Go to the next track (MP3 file*)	Turn the ◀◀ AMS ▶▶ dial clockwise by one click.
Go back to the preceding track (MP3 file*)	Turn the ◀◀ AMS ▶▶ dial counterclockwise by one click.
Stop playing and remove the disc	Press OPEN/CLOSE.

* When "ALL DISCS" or "1 DISC" is selected, you can locate all the MP3 files in the selected disc. When "ALBUM" is selected, you can locate all the MP3 files in the selected ALBUM.

 **When the TOC reading is completed**

When MP3 files on the disc are played back, "MP3" appears in the display.

 **When you turn off the player**

The player remembers the last playing disc and the play mode: Continuous (on page 12), Shuffle (on page 17), or Program (on page 19). When you turn on the player again, the player plays the same disc in the same play mode.

Note

If "⌂" appears in the large display, the disc has reached the end while you were pressing ▶▶. Turn the ◀◀ AMS ▶▶ dial counterclockwise or press ◀◀ to go back.

Using the Display

You can check stored disc information, such as the Disc Names (see page 23) or Artist Names (see page 27), by using the display.

Unlike a normal CD, a CD TEXT disc includes information such as the disc title or artist name. The display shows the CD TEXT information so that you can check the current disc title, artist name, and track title. When the player detects a CD TEXT disc, "CD TEXT" appears in the display.

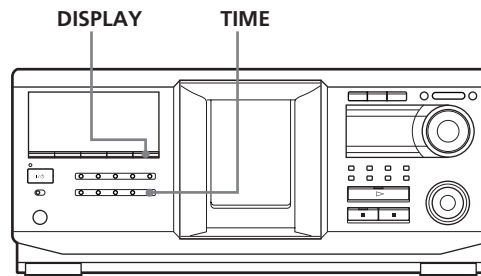

Display information of the normal discs

Display information in stop mode

The display shows the current disc number, total number of tracks, and total playing time of the disc.

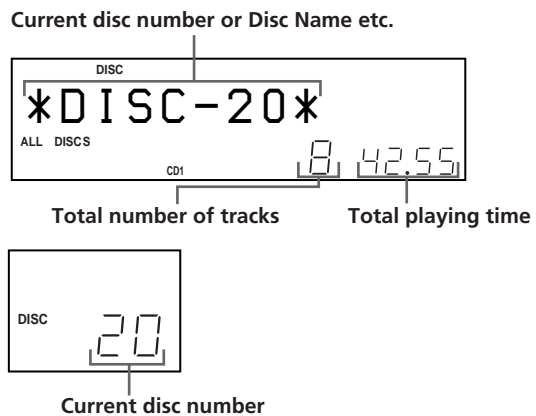

(continued)

Display information of the playing disc

While playing a disc, the display shows the current disc number, track number, playing time of the track, and the next disc number.

Current disc number or Disc Name etc.

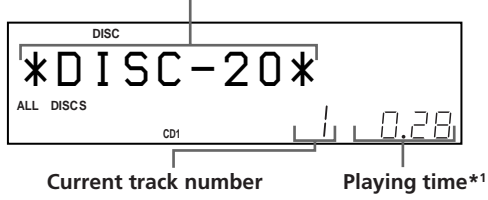

Next disc number

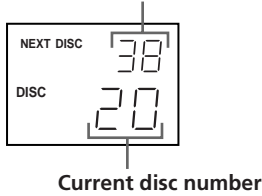

*¹ Each time you press TIME, the display changes as follows:

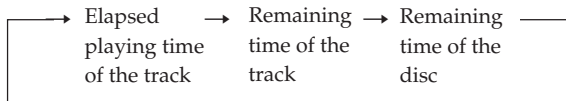

The information is displayed as follows (in stop mode):

- When the Artist Name is assigned to the current disc
Disc Name/Assigned Artist Name
When no disc name is assigned to the current disc, the current disc number is displayed.
- When no Artist Name is assigned to the current disc
Disc Name
When no disc name is assigned to the current disc, the current disc number is displayed.

Display information of CD TEXT discs

Display information in stop mode

The display shows the disc title. When you assign the Artist Name (see page 27), the artist name also appears and scrolls in the display.



Display information while playing a disc

The display shows the disc and track title alternately.

The information is displayed as follows (in stop mode):

- When the Artist Name is assigned to the current disc
Disc title of CD TEXT/Assigned Artist Name
- When no Artist Name is assigned to the current disc
Disc title of CD TEXT/Artist name of CD TEXT
Each time you press DISPLAY, the display changes as follows:
Disc title ↔ Track title

Display information of MP3 discs

Display information in stop mode

The display shows the disc name or the album name, total number of MP3 files in current album, total number of albums*, and current disc number.

* When ALL DISCS or 1 DISC is selected.

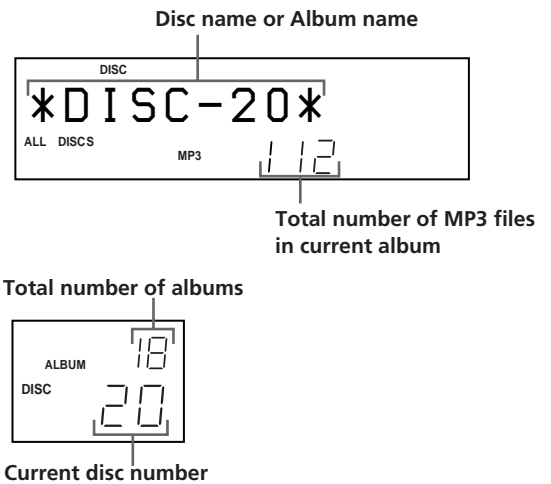

Display information of the playing disc

The display shows the MP3 file name, MP3 file number, playing time of the MP3 file, and current disc number.

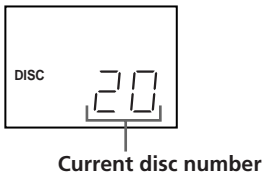
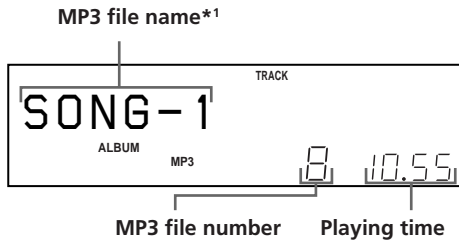

*¹ Each time you press DISPLAY, the display changes as follows:

When the MP3 file does not have ID3 tag

→ Disc name → Album (folder) name → MP3 file name

When the MP3 file has ID3 tag

→ Disc name → Album (folder) name → ID3 tag
title/album/
artist

Notes on MP3

- ID3 tag applies only to version 1.
- The ID3 tag character codes comply with ASCII and ISO standards. Joliet format discs can only be displayed in ASCII. Incompatible characters will be displayed as “ ”.
- In the following cases, elapsed playing time and time of the track remaining may not be displayed accurately.
 - when an MP3 file of VBR (variable bit rate) is played.
 - during fast-forward/reverse.
- When an MP3 file is played, the remaining time of the disc is not displayed.

Locating a Specific Disc

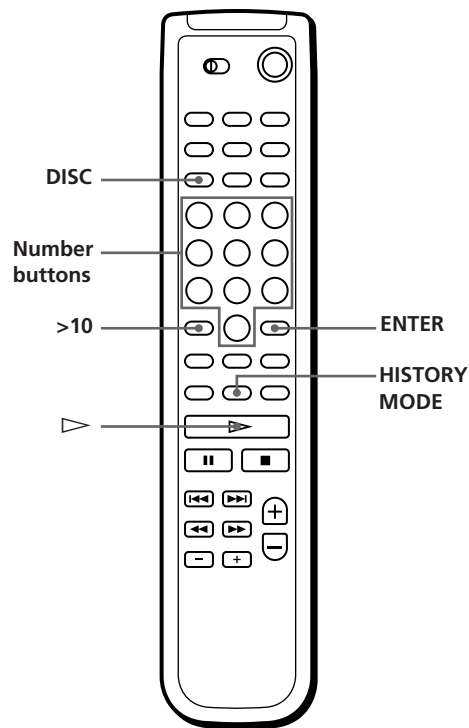
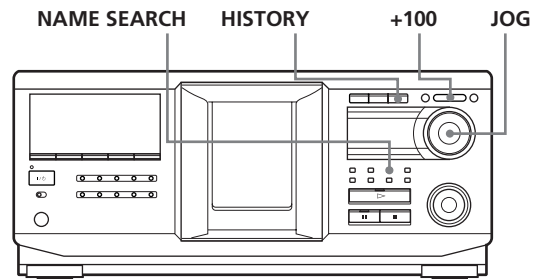

Locating a disc on the player

Turn the JOG dial until the desired disc number or Disc Name (see page 23) appears in the display. Push the JOG dial to start play.

To skip discs quickly

Press +100. Each time you press +100, the player skips 100 discs.

Locating a disc directly using the remote

- 1 Press DISC.
- 2 Press the number button of the disc.
Example: To enter number 35
Press 3 then 5.
To enter number 100
Press 1, then 10/0 twice.
- 3 Press ENTER to start play.

Locating a disc by searching for a specific Disc Name (Name Search)

You can search for and locate a desired disc by the first character of the Disc Name (see page 23). The Name Search function can display the Disc Name in alphabetical order.

- 1 Press NAME SEARCH.
“NAME SEARCH” appears in the display.
- 2 Turn the JOG dial to find the desired disc.
As you turn the JOG dial, the Disc Names starting with the input character appear in the display.

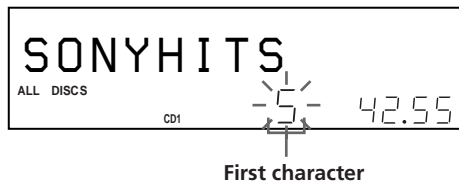

The following characters are displayed as the first character.

A B C D E F G H I J K L M N O P Q R S T U V W X
Y Z 0 1 2 3 4 5 6 7 8 9

If “NOT FOUND” appears in the display while inputting the first character with the JOG dial, no disc has been labeled using the input character.

Notes

- When searching for input characters, blanks and symbols before the first character in the Disc Name are ignored.
- When searching for input characters, upper and lower cases cannot be differentiated.

- 3 Push the JOG dial to select the disc.
In Program Play mode, the disc will be added to the end of the program.

To cancel Name Search

Press NAME SEARCH again.

Note

The Name Search function on the player does not work during ALL DISCS shuffle play.

Locating a disc searching in the playback history (History Search)

The player automatically stores the playback history of ten discs that are recently played back for 30 seconds or over. You can search and play a desired disc in the playback history.

- 1 Press HISTORY.
The indicator on the HISTORY button lights up and the disc number or Disc Name of the disc that is recently stored in the playback history appears in the display (History Mode).
- 2 Turn the JOG dial to select a desired disc.
Turn clockwise to select a previously stored disc and turn counterclockwise to select a recently stored disc.
- 3 Push the JOG dial to start playing the selected disc.
The indicator on the HISTORY button goes off and the History Mode is canceled.

Notes

- You cannot edit the playback history.
- The player stores a single disc in the playback history only once even if the disc is played several times.
- The playback history is stored only when the disc is played in Continuous or 1 DISC Shuffle Play mode.
- You can select History Mode only when the disc is being played in the Continuous mode or 1 DISC Shuffle Play mode.

Specifying the Next Disc to Play

You can specify the next disc to play while playing a disc in Continuous Play mode.

While playing a disc, turn the JOG dial. "NEXT DISC" flashes in the display and the disc number or Disc Name (see page 23) changes as you turn the JOG dial. When the desired disc number or Disc Name appears in the display, stop turning the JOG dial.

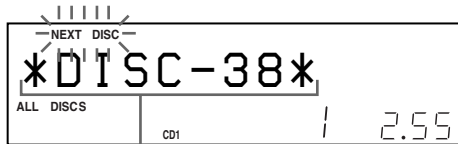

Next disc number or the Disc Name

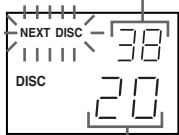

Current disc number

After the current disc is played, the next disc you have specified starts playing.

If you want to skip to the next disc right away, push the JOG dial while playing the current disc.

Playing Discs (Album) in Various Modes (Repeat/Shuffle Play)

You can play discs or tracks (MP3 files) repeatedly (Repeat Play) in any play mode.

You can also have the player "shuffle" the tracks (MP3 files) and play in random order (Shuffle Play). The player shuffles all the tracks on all discs or on the disc you specify.

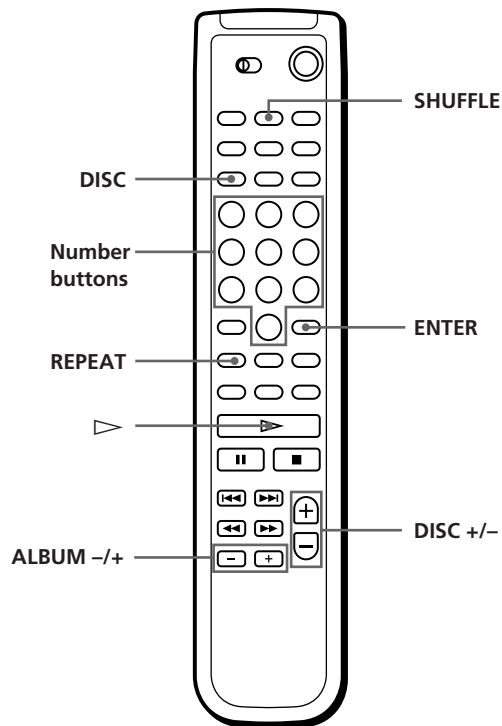
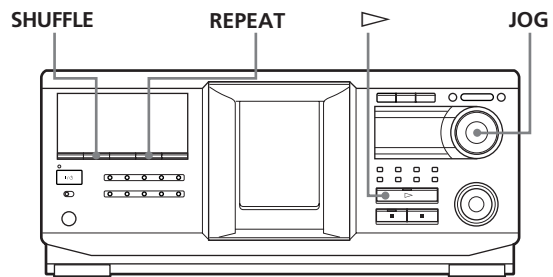

(continued)

Playing repeatedly (Repeat Play)

Press REPEAT while playing a disc. "REPEAT" appears in the display. The player repeats the discs/tracks (MP3 files) as follows:

When the disc is played in	The player repeats
ALL DISCS Continuous Play (page 12)	All tracks on all discs
1 DISC Continuous Play (page 12)	All tracks on the current disc
ALBUM Continuous Play (page 12)	All tracks on the current album.
1 DISC Shuffle Play (this page)	All tracks on the current disc in random order
ALBUM Shuffle Play (this page)	All tracks on the current album in random order
Program Play (page 19)	The same program

To cancel Repeat Play

Press REPEAT twice.

To repeat the current track (MP3 file)

While the track (MP3 file) you want is being played, press REPEAT one or more times until "REPEAT 1" appears in the display.



To cancel REPEAT 1 Play

Press REPEAT.

Notes on Repeat Play

- In all Repeat Play modes other than "REPEAT1," playback is repeated five times, and then stops.
- During "ALL DISCS SHUFFLE PLAY" mode, the only Repeat Play mode that can be selected is "REPEAT1."



Playing all tracks on all discs in random order

- 1 Press SHUFFLE repeatedly until "ALL DISCS" and "SHUFFLE" appear in the display.
- 2 Press . ALL DISCS Shuffle Play starts. " " appears in the display while the player is shuffling the discs or the tracks.

Note

Even if ALL DISCS Random Play mode is selected, the player may playback a single track two or more times.

Playing all tracks (MP3 files) on a specified disc (album) in random order

- 1 Press SHUFFLE repeatedly until "1 DISC" ("ALBUM") and "SHUFFLE" appear in the display.
- 2 Turn the JOG dial until the desired disc (album) number appears in the display. When using the remote, first press DISC, press the number button of the disc, and then press ENTER, or press ALBUM -/+ repeatedly.
- 3 Press . 1 DISC (ALBUM) Shuffle Play starts. " " appears in the display while the player is shuffling the tracks.

To cancel Shuffle Play

Press CONTINUE.



You can go to the next disc during 1 DISC Shuffle Play 

Press DISC +.

Note

You cannot specify the next disc to play during Shuffle Play.

Creating Your Own Program (Program Play)

You can arrange the order of the tracks (MP3 files), and/or discs (albums) to create three different programs. A program can contain up to 32 "steps." One "step" may contain a track (file) or a whole disc (album).

You can make programs using the controls on the remote or on the player. However, the programming procedures are different.

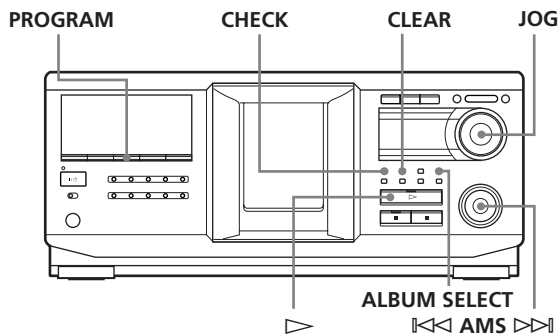

Creating a program on the player

1 Press PROGRAM until the desired program number (PROGRAM 1, 2, or 3) appears in the display. If a program is already stored in the selected program number, the last step of the program appears in the display. When you want to erase the whole program, hold down CLEAR until "CLEAR" appears in the display (see page 20).

2 Turn the JOG dial until the desired disc number appears in the display.

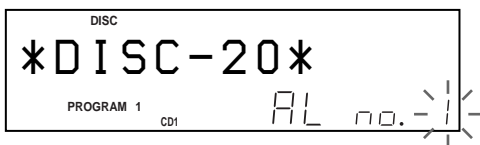

3 To program a whole disc, skip this step and go to step 7. To program a whole album or an MP3 file, go to step 4. To program an audio track, turn the AMS dial until the desired track number appears in the display and go to step 7.

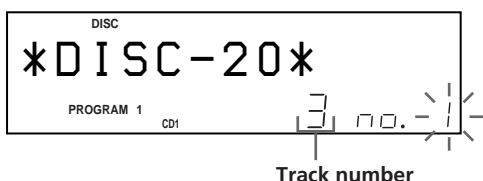

- 4** If the ALBUM SELECT button is off, press ALBUM SELECT.
- 5** Turn the JOG dial until the desired album number or album name appears in the display.
- 6** To program a whole album, skip this step and go to step 7. To program an MP3 file, turn the AMS dial until the desired MP3 file number appears in the display.

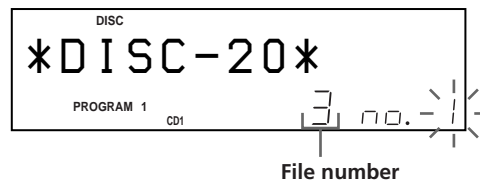

7 Push the JOG dial.

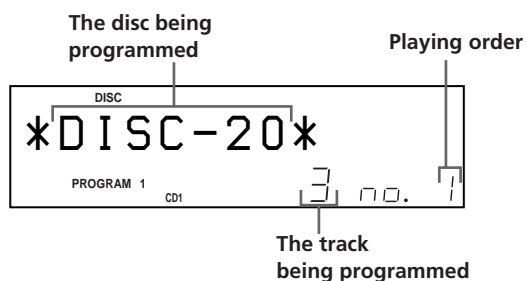

8 To program other discs (albums)/tracks (MP3 files), do the following:

To program	Repeat Step(s)
All tracks of another disc(s)	2 and 7
Other tracks on the same disc	3 and 7
Other tracks on other discs	2, 3, and 7
All MP3 files of another album(s)*	4, 5, and 7
Other MP3 files on the same album*	6 and 7
Other MP3 files on other albums*	4, 5, 6, and 7

* To select MP3 files on another disc, be sure to perform step 2 first.

9 Press > to start Program Play.

(continued)

To cancel Program Play

Press CONTINUE.



The programs remain even after Program Play ends

When you press ▷ in Program Play mode, you can play the same program again.



The program remains until erased

Even if you replace discs, the programmed disc (album) and track (MP3 file) numbers remain. Therefore, the player will play the new disc (album) and track (MP3 file) numbers. However, the programmed disc (album) and track (MP3 file) numbers that are not found in the player or on the disc are deleted from the program, and the rest of the program is played in the programmed order.



You can select the program number (PROGRAM 1,2, or 3) by using the remote

Press PROGRAM on the remote repeatedly until the desired program number appears in the display.

Note

If you select Artist Play mode (on page 29), Program Play will be canceled.

Checking the programmed order

You can check your program before or after you start playing.

Press CHECK.

Each time you press this button, the display shows the disc and track number (album name and MP3 file number) of each step in the programmed order. (When a whole disc (album) is programmed as one step, "AL" appears instead of the track (MP3 file) number.) After the last step in the program, the display shows "- END -" and returns to the original display.

Changing the programmed order

You can change your program before you start playing.

To	You need to
Erase a track (MP3 file) or disc (album)	Press CHECK until the track (MP3 file) or disc (album) you don't want appears in the display, then press CLEAR.
Erase the last track (MP3 file) or disc (album) in the program	Press CLEAR. Each time you press the button, the last programmed track (MP3 file) or disc (album) will be cleared.
Add tracks (MP3 file) or discs (albums) to the end of the program	Follow the programming procedure.

Erasing the program stored in memory

- 1 Press PROGRAM repeatedly in stop mode until the program number (PROGRAM 1, 2, or 3) you want to erase appears in the display.
- 2 Press and hold CLEAR.
The "steps" will be erased one at a time, starting with the last step in the program.

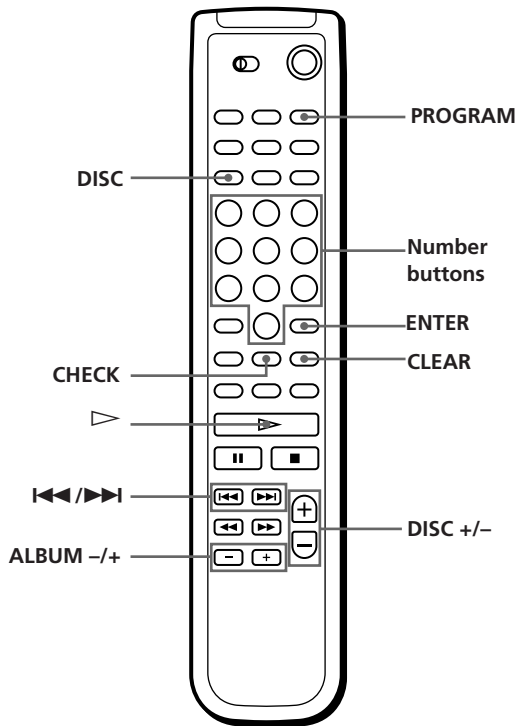

Creating a program using the remote 



- 1 Press PROGRAM until the number you want (PROGRAM 1, 2, or 3) appears in the display.
- 2 Press DISC +/- until the desired disc number appears in the display.
- 3 To program a whole disc, press ENTER and go to step 7.
To program an album, skip this step and go to step 4.
To program an audio track or an MP3 file, skip this step and go to step 6.



- 4 Press ALBUM +/- until the desired album number appears in the display.
- 5 To program a whole album, press ENTER and go to step 7.
To program an MP3 file, skip this step and go to step 6.

- 6 To program an audio track (MP3 file), press   until the desired track number appears in the display and press ENTER.

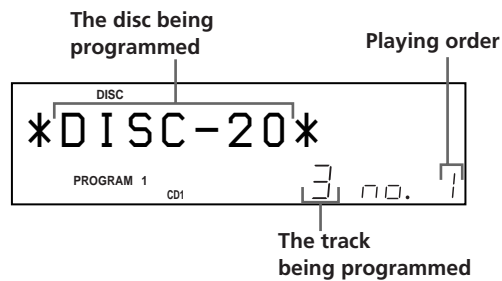

- 7 To program other discs (albums)/tracks (MP3 files), do the following:

To program	Repeat Step(s)
All tracks of another disc(s)	2 and 3
Other tracks on the same disc	6
Other tracks on other discs	2, 3, and 6
All MP3 files of another album(s)*	4 and 5
Other MP3 files on the same album*	6
Other MP3 files on other albums*	4 and 6

* To select MP3 files on another disc, be sure to perform step 2 first.

- 8 Press ENTER or  to start Program Play.

 **To program a whole disc**

You can also create a program by following the procedure below.
After performing step 1, press DISC, press the number button of the disc, and then press ENTER.

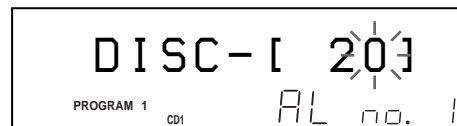

To cancel Program Play

Press CONTINUE.

 **You can check or change the program by pressing the CHECK or CLEAR button on the remote **

See page 20.

Using the Timer

You can start playing a disc at any given time by connecting a timer (not supplied). Refer also to the instructions for the timer if you need help.

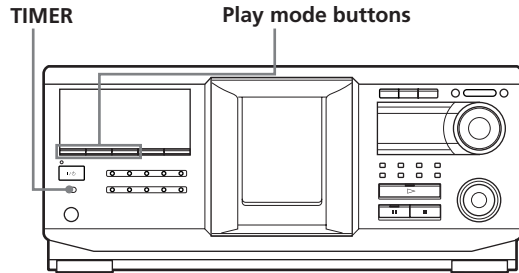

- 1 Press one of the play mode buttons to select the desired play mode.
- 2 Set TIMER on the player to PLAY.
- 3 Set the timer to the desired time, then stop the power supply to the player (if necessary). The player turns off. When the set time comes, the player turns on and starts playing.
- 4 After you have used the timer, set TIMER on the player to OFF.

Note

When using a second player connected to the master player's CONTROL A1 connector (see page 8) and an externally connected timer (not supplied), TIMER on the second player must be set to OFF. Only TIMER on the master player should be set to PLAY.

Fading In or Out

You can manually fade the sound in or out to prevent tracks from starting or ending abruptly.

Note that you cannot use this effect when you use the DIGITAL OUT (OPTICAL) connector.

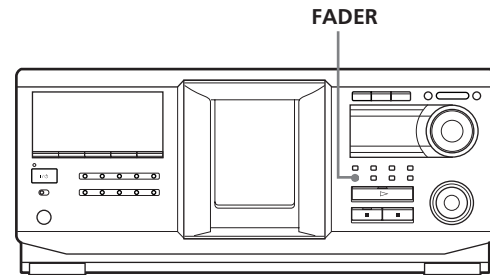

To	Press FADER
Start play fading in	During pause. "FADE" flashes and "FADE IN" appears in the display. The play fades in.
End play fading out	When you want to start fading out. "FADE" flashes and "FADE OUT" appears in the display. The play fades out and the player pauses.

Note

Fading lasts for about 5 seconds.

What You Can Do With the Custom Files

The player can store two types of information called "Custom Files" for each disc. Once you have stored Custom Files for a disc, the player automatically recalls what you have stored whenever you select the disc. Note that Custom Files are erased if you do not use the player for about one month.

You can store this information:

When you use	You can
Disc Name (page 23)	Label discs using up to 20 characters
Artist File (page 27)	Classify discs according to an artist name

Where are Custom Files stored?

Custom Files are stored not on the disc, but in the player's memory. Therefore you cannot use Custom Files when you play the disc on other players.

If you replace discs with Custom Files

The Custom File information you have stored remains, since the Custom File information is assigned to each slot. Erase all the Custom Files (Disc Name and Artist File) of the old disc, and then file the new disc information in the Custom Files.

Erasing all Custom Files of all discs

- 1 Press MENU/NO.
- 2 Turn the JOG dial until "ALL ERASE ?" appears.
- 3 Push the JOG dial.
"ALL ERASE ?" flashes.
- 4 Push the JOG dial.
"ALL ERASE" appears in the display, and all Custom Files are erased.

Note

When you perform the operation as described above, all of your own settings are deleted and the original factory settings are restored.

Labeling Discs (Disc Name)

You can label discs using up to 20 characters and have the player display the Disc Name each time you select the disc. The Disc Name can be anything you like, such as a title, musician's name, category, or date of purchase. You can also label the discs in the second player.

💡 When you select a CD TEXT disc

The disc title is automatically stored as the Disc Name. If the disc title has more than 20 characters, only the first 20 characters of the disc title are stored (see page 13). When you replace a disc with a CD TEXT disc, the disc title of the CD TEXT disc is also stored automatically. Note that you cannot change the Disc Name of a CD TEXT disc.

💡 You can label discs while the front cover is open

Labeling discs on the player

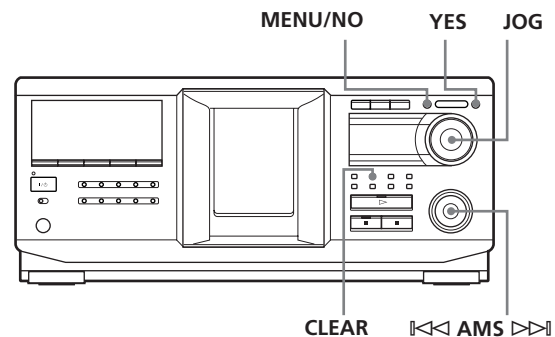

- 1 Turn the JOG dial until the disc number to which you want to assign a Disc Name appears in the display.
When you label a disc with the front cover closed, the disc number of the disc at the playing position appears.
When you label a disc with the front cover open, the disc number at the loading position appears.
- 2 Press MENU/NO.
"NAME IN ?" flashes.
- 3 Push the JOG dial.
The flashing cursor (␣) appears.

Storing Information About CDs (Custom Files)

- 4** Turn the JOG dial until the desired character appears in the display.
The cursor disappears and the first space for the Disc Name flashes.
As you turn the JOG dial clockwise, the characters appear in the following order. Turn the JOG dial counterclockwise to go in reverse order.

(space) A B C D E F G H I J K L M N O P Q R S T U
V W X Y Z a b c d e f g h i j k l m n o p q r s t u v w
x y z 0 1 2 3 4 5 6 7 8 9 ' - / , . () : ! ? & + < > _ = " ;
\$ % @ * `

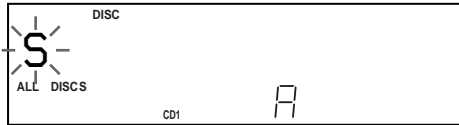

- 5** Push the JOG dial to select the character.
The selected character lights up, and the flashing cursor appears at the next space to be input.



To make a correction

Move the cursor to the position that you want to change, then press CLEAR and begin again by inputting the correct characters.

- 6** Repeat steps 4 and 5 to input more characters.
7 Press YES to store the Disc Name.
The display shows the Disc Name.



Repeat steps 1 to 7 to assign Disc Names to other discs.



To change the character type quickly while inputting characters

Press DISPLAY in step 4 above. The character on the cursor changes to the first character of each character type. Each time you press DISPLAY, the character type changes as follows:

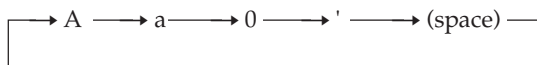

Changing the Disc Name

- 1** Follow steps 1 to 3 in "Labeling discs on the player" on page 23 to select the Disc Name you want to change.
2 Turn the ◀◀ AMS ▶▶ dial to move the cursor to the position you want to change.
When the cursor position is on a character, the character flashes but when the cursor position is on a blank space, the flashing cursor (␣) appears in the display.

To change characters

Turn the JOG dial until the desired character appears in the display.

To add characters

Push the JOG dial. The new blank space appears next to the selected character, then turn the JOG dial until the desired character appears in the display.

To erase characters

Press CLEAR. The selected character disappears.

- 3** Repeat step 2 to change more characters.
4 Press YES to store the Disc Name.

Erasing the Disc Name

- 1** Follow steps 1 to 3 in "Labeling discs on the player" on page 23 to select the Disc Name you want to erase.
2 Turn the ◀◀ AMS ▶▶ dial to move the cursor to the first character, then press and hold CLEAR until all the characters are erased.
3 Press YES.
The Disc Name disappears.

Labeling discs using the remote

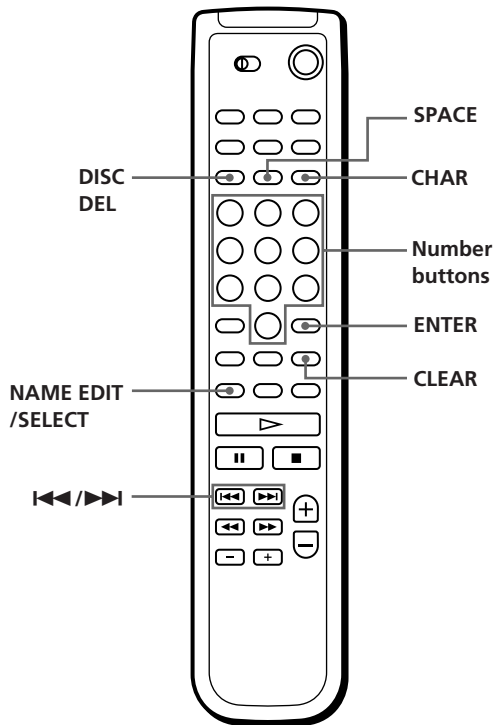

- 1 Press DISC.
- 2 Press the number button of the disc you want to label, then press ENTER.
- 3 Press NAME EDIT /SELECT. The flashing cursor (▬) appears.
- 4 Press NAME EDIT /SELECT to find the desired character type. Each time you press the button, the character type changes cyclically as follows:

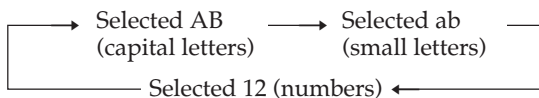

To select a symbol, select the capital or small letter type. The selected character type appears in the display.

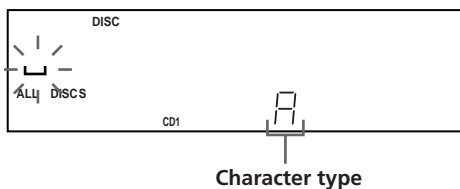

- 5 To input a letter, press the number button corresponding to the desired letter (indicated beside each number button). The cursor disappears and the first space for the Disc Name flashes. Each time you press the button, the letter changes cyclically among the ones indicated beside the button.

To input symbols, press the number button 1 repeatedly until the desired symbol appears in the display.

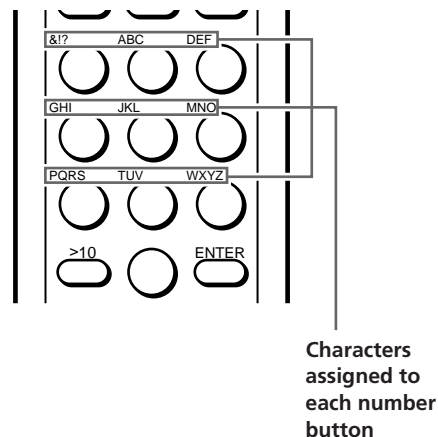

Example: To select the letter E
Press the number button 3 twice.

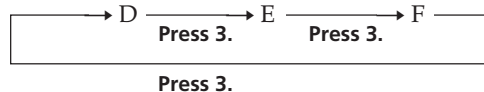

To input a space, press SPACE once.
To input a number, press NAME EDIT /SELECT twice to change the character type, then press the desired number button.

- 6 Press **▶▶** to select the character. The selected character lights up, and the flashing cursor appears at the next space to be input. You can also go to the next space by pressing other number buttons.
- 7 Repeat Steps 4 through 6 to input more characters.
- 8 Press ENTER to store the Disc Name. The Disc Name lights up in the display.



Repeat Steps 1 through 8 to assign Disc Names to other discs.

(continued)

Storing Information About CDs (Custom Files)

💡 If you make a mistake while inputting the character(s)

To correct a character that was input

- 1 Press **◀** or **▶** until the cursor moves to the incorrect character.



- 2 Press DEL to delete the incorrect character.

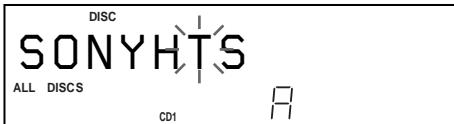

- 3 Input the correct character.



To correct the character currently being input

- 1 Press DEL to delete the incorrect character.
- 2 Input the correct character.

To insert a character(s) between the input characters

Press **◀** or **▶** until the cursor moves next to the point you want to insert, and enter the character(s).

Storing Custom File Information Using a Keyboard

You can store the Disc Name for each disc, one by one, using an IBM-compatible PC keyboard* (not supplied).

* The keyboard's power consumption must be 120 mA or less.

Keyboard jack

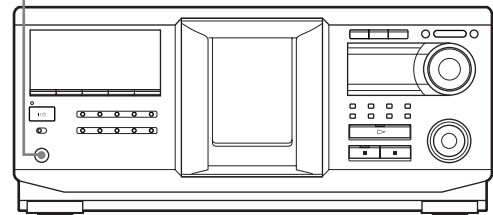

- 1 Connect a keyboard to the keyboard jack on the front panel of the player.

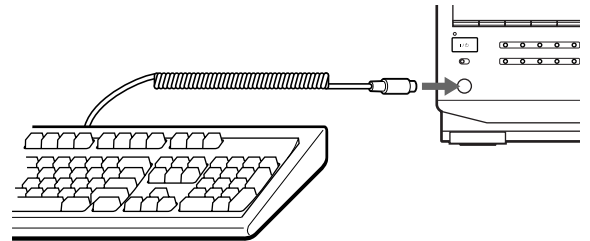

- 2 After selecting the desired disc on the player, press the Enter key.
- 3 Input the desired characters, then press the Enter key to store the information.

💡 You can delete all characters of a selected item
While holding down the Shift key, press the Delete key.

Notes

- If the cursor keys do not work correctly and you cannot complete the task using the keyboard, disconnect the keyboard then reconnect it to the player and try again.
- If the keyboard is not a USA model (shown below), the characters may be input differently from those on the keys.

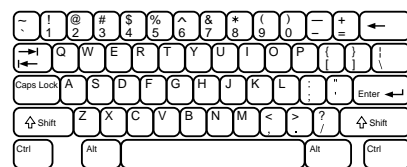

Classifying Discs According to Artist Name (Artist File)

You can classify discs by storing Artist Names into the player and assigning them to each disc. Each Artist Name can use up to 20 characters. Once you assign an Artist Name to a disc, you can enjoy Continuous, Shuffle, or Repeat Play within discs assigned same Artist Name and you can search for the desired disc easily. You can also store a category name instead of an Artist Name. Up to 200 Artist Names can be stored.

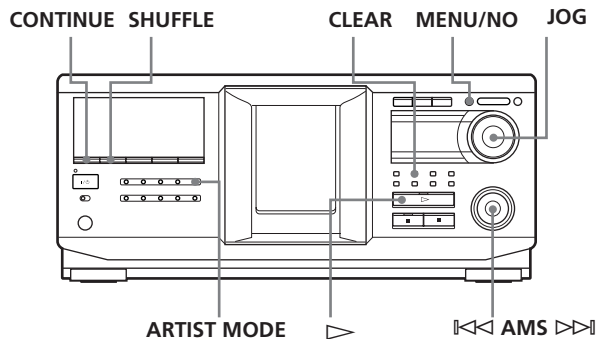

Storing the Artist Name

- 1 Press MENU/NO.
- 2 Turn the JOG dial until "ART.NAME IN?" appears in the display.
- 3 Push the JOG dial. "New Artist" flashes.
- 4 Push the JOG dial. The flashing cursor (▣) appears.
- 5 Turn the JOG dial until the desired character appears in the display. The cursor disappears and the first space for the Artist Name flashes. As you turn the JOG dial clockwise, the characters appear in the following order. Turn the JOG dial counterclockwise to go in reverse order.

(space) A B C D E F G H I J K L M N O P Q R S T U
 V W X Y Z a b c d e f g h i j k l m n o p q r s t u v w
 x y z 0 1 2 3 4 5 6 7 8 9 ' - / , . () : ! ? & + < > _ = " ;
 # \$ % @ * `

- 6 Push the JOG dial to select the character. The selected character lights up, and the flashing cursor appears to indicate the next space to be input.
 - To make a correction**
Press CLEAR and begin again by inputting the correct characters.
- 7 Repeat steps 5 and 6 to input more characters. See also "Labeling discs on the player" on page 23 for details.
- 8 Press YES to store the Artist Name.

Changing the Artist Name

- 1 Follow steps 1 to 3 in "Storing the Artist Name" on this page.
- 2 Turn the JOG dial until the artist name you want to change appears in the display, then push the JOG dial.
- 3 Turn the ◀◀ AMS ▶▶ dial to move the cursor to the position you want to change. When the cursor position is on the character, the character flashes, and when the cursor position is on a blank space, the cursor (▣) appears in the display.
 - To change characters**
Turn the JOG dial until the desired character appears in the display.
 - To add characters**
Push the JOG dial. The new blank space appears next to the selected character, then turn the JOG dial until the desired character appears in the display.
 - To erase characters**
Press CLEAR. The selected character disappears.
- 4 Repeat step 3 to change more characters.
- 5 Press YES to store the Artist Name.

Storing Information About CDs (Custom Files)

You can also erase the Artist Name while assigning the Artist Name

- 1 In step 2 above, turn the JOG dial until the Artist Name you want to erase appears in the display, then push the JOG dial.
- 2 Turn the \lll AMS \ggg dial to move the cursor to the first character, then press and hold CLEAR until all the characters are erased.
- 3 Press YES.
The Artist Name and "ARTIST ERASE?" appear alternately in the display.
- 4 Press YES.
The Artist Name is erased.

Erasing the Artist Name

- 1 Press MENU/NO.
- 2 Turn the JOG dial until "ARTIST FILE?" appears in the display.
- 3 Push the JOG dial.
- 4 Turn the JOG dial until the desired Artist Name appears in the display.
- 5 Press and hold CLEAR for a few seconds.

Note

When you erase the Artist Name, the Artist File of the Artist Name is also erased.

Assigning an Artist Name to a disc (Artist File)

- 1 Turn the JOG dial to select the disc you want to assign an Artist Name.

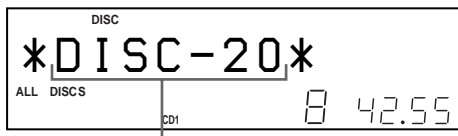

The disc to be assigned the artist name.

- 2 Press MENU/NO.
- 3 Turn the JOG dial until "ARTIST FILE?" appears in the display.
- 4 Push the JOG dial.

- 5 Turn the JOG dial until the desired Artist Name appears in the display.
The Artist Names are displayed in alphabetical order.

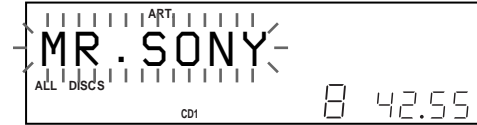

- 6 Press the JOG dial to assign the Artist Name.



You can assign an Artist Name to a disc while the front cover is open

Notes

- You cannot assign an Artist Name to a disc when no Artist Name is stored. In this case, "ARTIST FILE?" does not appear in the display in step 3 above.
- You cannot assign an Artist Name to an album.

Removing the Artist Name from the disc

- 1 Turn the JOG dial to select the desired disc.
- 2 Press MENU/NO.
- 3 Turn the JOG dial until "ARTIST FILE?" appears in the display.
- 4 Push the JOG dial.
- 5 Turn the JOG dial counterclockwise until "FILE ERASE?" appears in the display, then push the JOG dial.
The assigned Artist Name is removed from the selected disc.

Playing discs assigned the same Artist Name (Artist Play)

You can enjoy Continuous or Shuffle Play within discs that are assigned the same Artist Name.

- 1 Select the desired play mode before you start playing.

When you select	The player plays
ALL DISCS Continuous Play	All tracks on all discs assigned same artist name consecutively
1 DISC Continuous Play	All tracks on the specified disc assigned same artist name consecutively
ALBUM continuous Play	All tracks on the specified album assigned same artist name consecutively.
ALL DISCS Shuffle Play	All tracks on all discs assigned same artist name in random order
1 DISC Shuffle Play	All tracks on the specified disc assigned same artist name in random order
ALBUM Shuffle Play	All tracks on the specified album assigned same artist name in random order.

- 2 Press ARTIST MODE.
The ARTIST MODE button flashes.
- 3 Turn the JOG dial to select the desired Artist Name.
- 4 Push the JOG dial.
The ARTIST MODE button lights up.
- 5 Turn the JOG dial to select the desired disc, then push the JOG dial.

To cancel Artist Play

Press ARTIST MODE so that the ARTIST MODE button goes off.

You can specify the disc to play when starting Artist Play

After selecting the Artist Name, turn the JOG dial to select the disc, then push the JOG dial.

Notes

- You cannot select an Artist Name if no discs are assigned to that Artist Name.
- When no Artist Name is stored, "NO ENTRY" appears in the display.

Playing discs assigned the same Artist Name with one-touch of a TOP ARTIST button (Top Artist Play)

It is required to assign an Artist Name to each TOP ARTIST 1 to 8 buttons beforehand.

To assign an Artist Name to a TOP ARTIST button

- 1 Press MENU/NO.
- 2 Turn the JOG dial until "TOP ART. SET?" appears in the display.
- 3 Push the JOG dial.
- 4 Turn the JOG dial to select the desired TOP ARTIST button to which an Artist Name is to be assigned.
During the selection, the selected button lights up and "NO ENTRY"* appears in the display.
* When an Artist Name is assigned to the selected button, the Artist Name appears.
- 5 Push the JOG dial.
- 6 Turn the JOG dial to select the desired Artist Name to be assigned to the selected TOP ARTIST button. As you turn the JOG dial clockwise, the Artist Names appear in alphabetical order. Turn the JOG dial counterclockwise to go in reverse order. To cancel the Artist Name assignment, select "NO ASSIGN?"
- 7 Push the JOG dial.

To play discs assigned the same Artist Name by using the TOP ARTIST buttons

- 1 Press one of TOP ARTIST 1 to 8.
Top Artist Play starts.

You can play discs assigned to the TOP ARTIST buttons by using the remote

- 1 Press TOP ARTIST.
- 2 Press the number button of the TOP ARTIST.
- 3 Press ENTER to start playback.

Controlling Another CD Player (Advanced Mega Control)

This unit can control a second CD player (see "Connecting another CD player" on page 8). Even when a second CD player is connected, the controls on both of the units will function. When you press the play button on either unit, the operating player stops and the idle player starts. Make sure that "2nd DETECTED" appears in this player's display after turning on both players. Note that, you cannot operate all the functions of the second CD player (e.g. selecting the desired album or a track whose track number is 99 or over with number buttons, etc.).

The controls indicated in the illustration below are effective while the MEGA CONTROL button is lit. To operate the master player, press MEGA CONTROL so that the MEGA CONTROL button goes off, and to operate the second player, press MEGA CONTROL so that the MEGA CONTROL button lights up.

Note

When a second player is connected to the master player's CONTROL A1II (or CONTROL A1) connector, be sure to play MP3 files on the master player. In this configuration, MP3 files may not play properly when played on the second player.

Play mode buttons
(CONTINUE/SHUFFLE/
PROGRAM/REPEAT)

MEGA CONTROL MENU/NO JOG

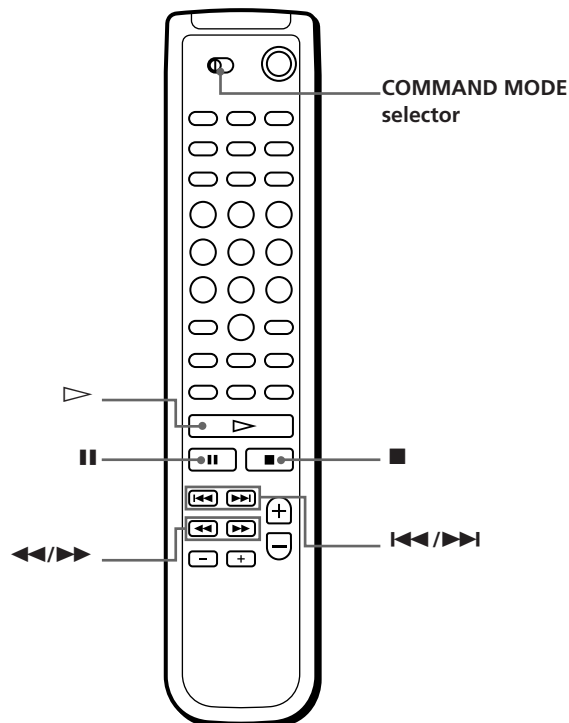
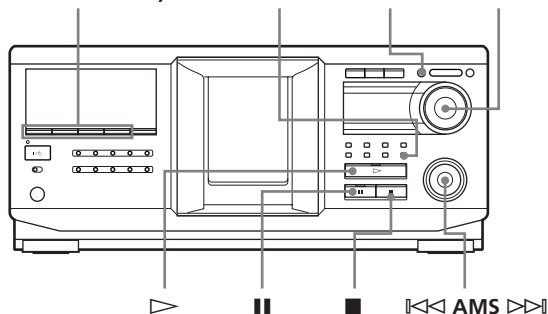

- 1 Press MEGA CONTROL on this player. The MEGA CONTROL button and "2nd" in the display light up. The display shows the current disc number or Disc Name of the second player.

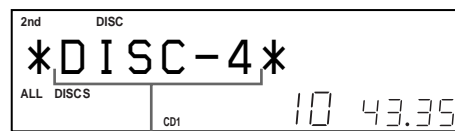

Current disc number or the Disc Name

- 2 Select the desired play mode. To program tracks, use the controls on the second player.
- 3 Press ▷ on this player to start playing. The play starts and the display shows the current disc, track numbers, and the playing time of the track. While the MEGA CONTROL button is lit, you can control the second player with the controls on this player.

To control the master player again

Press MEGA CONTROL. The MEGA CONTROL button goes off and you can control the master player.

To control the second player directly using the supplied remote

Set CD1/2/3 on the remote to CD3 which is the same position as the COMMAND MODE selector on the rear panel of the second player.

Loading the Disc Names of the second CD player

If the second CD player has the Disc Name function (see page 23), you can load the Disc Names of the second CD player into this player's memory and display them on this player.

- 1 Press MENU/NO.
- 2 Turn the JOG dial until "LOAD 2ndNAME?" flashes in the display.

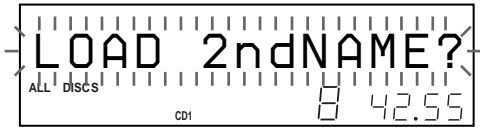

- 3 Push the JOG dial.
This player starts loading. (Loading takes about one minute.)

Labeling discs of the second CD player

You can label discs of the second CD player or change the Disc Names loaded from the second CD player.

- 1 Press MEGA CONTROL.
The MEGA CONTROL button lights up.
- 2 Turn the JOG dial to select the disc you want to assign a Disc Name to.
If the disc slot you select does not contain a disc, "NO DISC" appears in the display.
- 3 Press MENU/NO.
"NAME IN?" appears.
- 4 Push the JOG dial.
- 5 Input the new Disc Name following the procedure in "Labeling discs (Disc Name)" on page 23.

Note

The new Disc Names are stored on this player's memory, so you cannot display them on the second CD player.

Playing Alternately (No-Delay Play/X-Fade Play)

When you connect a second player, you can play tracks in this player and those from the second player alternately in any play mode (see "Connecting another CD player" on page 8).

Select one of the following methods:

- **No-Delay Play:** The current player changes at each track. Each time the current player changes to the other player, the other player starts play without a break in sound immediately after the current player ends play. The other player skips the lead-in portion and starts playing from where the sound actually begins.
- **X-Fade Play:** The current player changes at each track or at the specified interval. You can select the interval, 30, 60, or 90 seconds. Each time the current player changes to the other player, the sound from both players is mixed. The current player ends play by fading out, and the other player starts play by fading in.

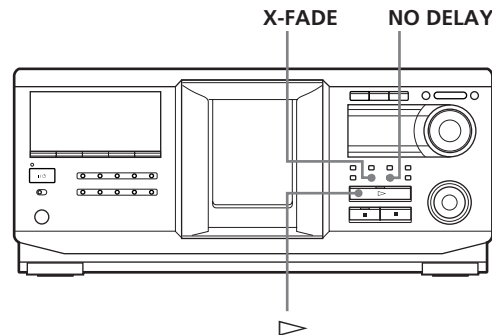

- 1 Select the desired disc and play mode for each player.
- 2 **When you select No-Delay Play**
Press NO DELAY.
"NO DELAY" appears in the display.

When you select X-Fade Play

Press X-FADE.

"X-FADE" appears in the display.

Each time you press the X-FADE button, the indication appears as follows:

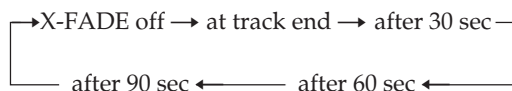

To change the current player each time a whole track is finished, select "at track end."

To change the current player at the specified interval, press X-FADE repeatedly until the interval you want appears in the display.

(continued)

- 3 Press \triangleright to start playing.
The MEGA CONTROL button lights up when a track in the second player is selected.

To cancel No-Delay/X-Fade Play

Press the corresponding button repeatedly until "NO DELAY" or "X-FADE" disappears from the display. The current player continues playing.



You can change the method (No-Delay or X-Fade) during play

Press the corresponding button (NO DELAY or X-FADE) following the procedure in step 2.



You can start X-Fade at any point of the track

Press FADER during X-Fade Play. Even after you have set the X-Fade mode and started X-Fade play, you can start X-Fade manually at any point you like. Note that you cannot do this operation while the sound from both players is mixed.

Notes

- Play starts from the second player if you start play while the MEGA CONTROL button is lit.
- When one player has played all the discs or tracks in the player ahead of the other player, play stops.
- Do not use the controls on the second player during No-Delay/X-Fade Play. They may not work correctly.

Controlling the Player by Another Unit

When you connect the player to a Sony MD deck compatible with the Mega Control function, or operate a Sony MD deck by using computer software such as "MD Editor," you must set the player as described below:

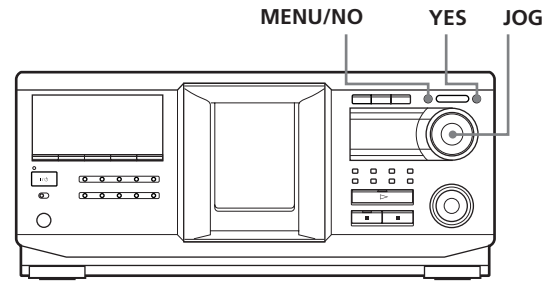

- 1 Press MENU/NO.
- 2 Turn the JOG dial until "CONTROL A1 ?" appears in the display window.
- 3 Press YES.
"CONTROL A1??" appears in the display.
- 4 Press YES.

To return to normal setting

After following steps 1 and 2, and "CONTROL A1II ?" is displayed, then press YES.

Notes

- You can perform the operation above correctly only when you operate Disc 1 to Disc 200.
- You cannot operate this player correctly from another player that does not have the CONTROL A1II jack. In this case, operate the other player from this player.

Using the CONTROL A1II control system

This player is compatible with the CONTROL A1II Control System.

The CONTROL A1II control system was designed to simplify the operation of audio systems composed of separate Sony components. CONTROL A1II connections provide a path for the transmission of control signals that enable automatic operation and control features usually associated with integrated systems.

Currently, CONTROL A1II connections between a Sony MD deck, CD player, amplifier (receiver), and cassette deck provide automatic function selection and synchronized recording.

In the future the CONTROL A1II connection will work as a multifunction bus allowing you to control various functions for each component.

Note

The CONTROL A1II control system is designed to maintain upward compatibility as the control system is upgraded to handle new functions. In this case, however, older components will not be compatible with the new functions.

CONTROL A1II and CONTROL A1 compatibility

The CONTROL A1 control system has been updated to the CONTROL A1II which is the standard system in the Sony 300 disc CD changer and other recent Sony components.

Components with CONTROL A1 jacks are compatible with components with CONTROL A1II jacks, and can be connected to each other. Basically, the majority of the functions available with the CONTROL A1 control system will be available with the CONTROL A1II control system. However, when making connections between components with CONTROL A1 jacks and components with CONTROL A1II jacks, the number of functions that can be controlled may be limited depending on the component. For detailed information, refer to the operating instructions supplied with the component(s).

Connecting the CONTROL A1II control system

Connect monaural (2P) mini-plug cables in series to the CONTROL A1II jacks on the back of each component. You can connect up to ten CONTROL A1II compatible components in any order. However, you can connect only one of each type of component (i.e., 1 CD player, 1 MD deck, 1 tape deck and 1 receiver). (You may be able to connect more than one CD player or MD deck, depending on the model. Refer to the operating instructions supplied with the respective component for details.)

Example

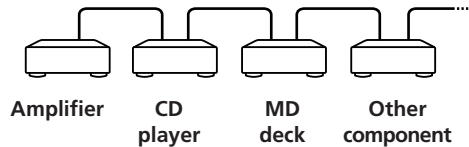

In the CONTROL A1II control system, the control signals flow both ways, so there is no distinction of IN and OUT jacks. If a component has more than one CONTROL A1II jack, you can use either one, or connect different components to each jack.

About the connecting cable

When a CONTROL A1II compatible component is not supplied with a connecting cable, use a commercially available monaural (2P) mini-plug cable less than 2 meters long, with no resistance (such as the Sony RK-G69HG).

Basic functions of the CONTROL A1II control system

Automatic function selection

When you connect CONTROL A1II compatible Sony components using CONTROL A1II cables (not supplied), the function selector on the amplifier (or receiver) automatically switches to the correct input when you press the play button on one of the connected components.

(For example, when you press \triangleright (play button) on the CD player while the MD deck is playing, the function selector on the amplifier switches from MD to CD.)

Notes

- This function works only when the components are connected to the amplifier (or receiver) inputs according to the names on the function buttons. Certain receivers allow you to switch the names of the function buttons. In this case, refer to the operating instructions supplied with the receiver.
- When recording, do not play any components other than the recording source. It will cause the automatic function selection to operate.

Synchronized recording

This function lets you conduct synchronized recording between the CD and the recording component.

- 1 Set the source selector on the amplifier (or receiver) to the CD.
- 2 Set the CD to playing pause mode (make sure both the \triangleright and \parallel indicators light together).
- 3 Set the recording component to recording pause mode.
- 4 Press \parallel on the deck.
The CD is automatically released from pause mode, and recording begins shortly thereafter. When play ends from the CD, recording stops.

Tip

Certain recorder components may be equipped with a special synchronized recording function that uses the CONTROL AIII Control System; like "CD Synchro Dubbing." In this case, refer to the Operating Instructions supplied with the recorder component.

Note

Do not set more than one component to the pause mode.

Precautions

On safety

- Caution — The use of optical instruments with this product will increase eye hazard.
- Should any solid object or liquid fall into the cabinet, unplug the player and have it checked by qualified personnel before operating it any further.

On power sources

- Before operating the player, check that the operating voltage of the player is identical with your local power supply. The operating voltage is indicated on the nameplate at the rear of the player.
- The unit is not disconnected from the AC power source (mains) as long as it is connected to the wall outlet, even if the unit itself has been turned off.
- If you are not going to use the player for a long time, be sure to disconnect the player from the wall outlet. To disconnect the AC power cord (mains lead), grasp the plug itself; never pull the cord.
- The AC power cord must be changed only at the qualified service shop.

On placement

- Place the player in a location with adequate ventilation to prevent heat build-up in the player.
- Do not place the player on a soft surface such as a rug that might block the ventilation holes on the bottom.
- Do not place the player in a location near heat sources, or in a place subject to direct sunlight, excessive dust or mechanical shock.

On operation

- If the player is brought directly from a cold to a warm location, or is placed in a very damp room, moisture may condense on the lenses inside the player. Should this occur, the player may not operate properly. In this case, leave the player turned on for about an hour until the moisture evaporates.

On adjusting volume

- Do not turn up the volume while listening to a portion with very low level inputs or no audio signals. If you do, the speakers may be damaged when a peak level portion is played.

On cleaning

- Clean the cabinet, panel and controls with a soft cloth slightly moistened with a mild detergent solution. Do not use any type of abrasive pad, scouring powder or solvent such as alcohol or benzine.

On transportation

- When transporting the player, open the front cover then remove all the discs from the player and turn the power off.

If you have any questions or problems concerning your player, please consult your nearest Sony dealer.

Troubleshooting

If you experience any of the following difficulties while using the player, use this troubleshooting guide to help you remedy the problem. Should any problem persist, consult your nearest Sony dealer.

There's no sound.

- ➔ Check that the player is connected securely.
- ➔ Make sure you operate the amplifier correctly.

The CD does not play.

- ➔ There's no CD inside the player ("NO DISC" appears). Insert a CD.
- ➔ Insert the CD with the label side facing right.
- ➔ Clean the CD (see page 3).
- ➔ Moisture has condensed inside the player. Remove the disc and leave the player turned on for about an hour (see page 34).

The remote does not function.

- ➔ Remove obstacles in the path of the remote and the player.
- ➔ Point the remote at the remote sensor  on the player.
- ➔ Be sure to set up the remote correctly.
- ➔ Replace all the batteries in the remote with new ones if they are weak.
- ➔ Set the command mode of the remote according to the command mode of the player.

The player functions incorrectly.

- ➔ The microcomputer chips may be operating incorrectly. Disconnect the AC power cord, then connect it back to the wall outlet to reset the player.

MP3 files cannot be played back.

- ➔ Recording was not performed according to the ISO 9660 level 1 or level 2 format, or the Joliet or Romeo in the expansion format.
- ➔ The file extension ".MP3" is not added to the file name.
- ➔ Files are not stored in MP3 format.

MP3 files take longer to play back than others.

- ➔ The following discs take a longer time to start playback.
 - a disc recorded with complicated tree structure.
 - a disc recorded in Multi Session.
 - a disc to which data can be added (non-finalized disc).

About ID3 tag version 2

Although not a malfunction, the following occurs when an MP3 file containing ID3 tag ver.2 is played:

- When skipping a portion of ID3 tag ver.2 (at the beginning of the track), sound is not output. Skip time changes depending ID3 tag ver.2 capacity.
Example: At 64 kbytes, it is about 2 seconds (with RealJukebox).
- The displayed elapsed playing time when skipping a portion of ID3 tag ver.2 is inaccurate. For MP3 files of a bit rate other than 128 kbps, time is not displayed accurately during playback.
- When an MP3 file is created with MP3 conversion software (ex. RealJukebox*), ID3 tag ver.2 will automatically be written.
* *"RealJukebox is a registered trademark of RealNetworks, Inc."*
As of December, 2001

Specifications

Compact disc player

Laser	Semiconductor laser ($\lambda = 780 \text{ nm}$) Emission duration: continuous
Laser output	Max 44.6 μW * * This output is the value measured at a distance of 200 mm from the objective lens surface on the Optical Pick-up block with 7 mm aperture.
Frequency response	20 Hz to 20 kHz $\pm 0.5 \text{ dB}$
Signal-to-noise ratio	More than 108 dB
Dynamic range	More than 87 dB
Harmonic distortion	Less than 0.009%

Output

	Jack type	Maximum output level	Load impedance
LINE OUT	Phono jacks	2 V (at 50 kilohms)	Over 10 kilohms
DIGITAL OUT (OPTICAL)	Optical output connector	-18 dBm	Wave length: 660 nm

General

Power requirements	120 V AC, 60 Hz
Power consumption	16 W
Dimensions (approx.) (w/h/d)	430 \times 189 \times 537 mm (17 \times 7 1/2 \times 21 1/4 in.) incl. projecting parts
Mass (approx.)	8.8 kg (19 lbs 7 oz.)

Supplied accessories

See page 6.

Design and specifications are subject to change without notice.

Index

A, B

- Advanced Mega Control 30
- AMS 13
- Artist name 27
- Automatic Music Sensor. *See* AMS

C

- CD TEXT 13
- Changing
 - Artist Name 27
 - Disc Name 24
- Connecting
 - another CD player 8
 - system 6
- Continuous Play 12
- Controlling another CD player 30
- Custom Files
 - Artist File 27
 - Disc Name 23
 - what you can do with 23

D

- Disc Name 23

E

- Erasing
 - Artist Name 28
 - Custom Files 23
 - Disc Name 24

F

- Fading 22

H

- Handling CDs 3
- History Search 16
- Hookups
 - overview 6

I

- Inserting CDs 9

J, K

- JOG dial 9

L

- Labeling a disc 23
- Locating
 - by monitoring 13
 - by scanning 13
 - directly 16
 - using AMS 13

M

- MP3 file 3

N, O

- Name Search 16
- No-Delay Play 31

P, Q

- Playback
 - Artist Name Play 29
 - Continuous Play 12
 - Playing alternately 31
 - Program Play 19
 - Repeat Play 17
 - Shuffle Play 17
 - X-Fade Play 31
- Program
 - changing 20
 - checking 20
 - creating 19
 - erasing 20

R

- Remote control 6
- Repeating 17
- Rotary table 9

S

- Searching. *See* Locating
- Shuffle Play 17
- Specifying the next disc 17
- Storing information about CDs 23

T

- Timer play 22
- Top Artist Play 29
- Troubleshooting 35

U, V, W

- Unpacking 6

X, Y, Z

- X-Fade Play 31

Names of controls

Buttons

- ALBUM SELECT 12
- ALBUM +/- 12
- ARTIST MODE 29
- CHAR 25
- CHECK 20
- CLEAR 20
- CONTINUE 12
- DEL 26
- DISC 16
- DISC +/- 12
- DISPLAY 14
- ENTER 16
- FADER 22
- HISTORY 16
- HISTORY MODE 16
- MEGA CONTROL 30
- MENU/NO 9, 23
- NAME EDIT/SELECT 25
- NAME SEARCH 16
- NO DELAY 31
- Number 16
- OPEN/CLOSE 9
- PROGRAM 19
- REPEAT 18
- SHUFFLE 18
- SPACE 25
- TIME 14
- TOP ARTIST 1-8 29
- X-FADE 31
- YES 24, 32
- ▷ 12
- ▣ 12
- 12
- ⊕ 11
- ◀◀/▶▶ 13
- ◀◀/▶▶ 13
- > 10 13
- +100 15

Control

- JOG dial 9
- ◀◀◀ AMS ▶▶▶ 13

Switches

- COMMAND MODE 30
- TIMER 22
- I/⏻ 12

Jacks

- CONTROL A1II 7
- DIGITAL OUT (OPTICAL) 7
- 2ND CD IN 8

Others

- Disc slots 9
- Display 13
- Front cover 9
- Rotary table 9
- Ⓜ 6

